

Desking + Tables

Effective March 1, 2019
Revised February 1, 2021



PRICE LIST desking + tables



think global

THE GLOBAL EDGE

ERGONOMICS IN THE TOTAL OFFICE

- One stop shopping for a full range of office furniture.
- Seating, desks, tables, files, modular furniture, panels and accessories.
- Ergonomics, competitive pricing and built-in value.

STRENGTH AND STABILITY

- Established in 1966.
- One of North America's largest office furniture manufacturers.
- Manufacturing and showrooms worldwide.

QUICK SHIP - INSTOCK

- Hundreds of products in stock for immediate delivery.

STRONG LOCAL REPRESENTATION

- Service and expert advice where you are, when you need it!

MANUFACTURING CAPABILITY

- Vertical integration ensures "start to finish" control.
- Ongoing research and investment in new, innovative production technology.

QUALITY ASSURANCE

- Quality Assurance Program is qualified by C.G.S.B. ISO9001 standards.
- On-site furniture testing facility.
- Product and components are tested to ANSI/BIFMA standards.

ENVIRONMENTAL COMMITMENT

- Continuous development of "earth friendly" programs.
- One of the first molded foam manufacturers to create ozone-friendly, CFC and HFC-free processes.
- Seat and back pans are made from recyclable plastics and wood waste, enabling little waste and cost effective products.

SYMBOL IDENTIFICATION



Global's Certified Products are in compliance with the stringent emission guidelines set by the GREENGUARD Environmental Institute and include all Upholstered Seating. To obtain a GREENGUARD Certificate for any product, please go to the product page on our website www.globalfurnituregroup.com and click on "View GREENGUARD Certificate".



level™ certification, based on the ANSI/BIFMA e3-2012 furniture sustainability standard, sets furniture manufacturers on a path toward greater sustainability over time. Based on environmental and social criteria set forth in the standard, a product's entire supply chain is assessed.



Certification assessment includes an evaluation of specific corporate policies and guidelines and an assessment of associated company manufacturing facilities. Products must meet quantifiable milestones of environmental and social performance at every step of development.

The quantitative assessment addresses four categories: material use, energy and atmosphere impacts, human and ecosystem health and social responsibility.

Manufacturers earn points in each of the four categories. The level™ brand and its numeric rating of 1, 2 or 3 indicate what threshold of certification a product has achieved. level™ 3 is the highest rating.

TABLE OF CONTENTS

WORKPLACE

LAMINATE DESKS

Adaptabilities.....	9
Consumer Education.....	6
Office Accessories.....	540
Desking Comparison Chart.....	4
Genoa.....	48
Halton.....	60
Laminate Desk Notes.....	8
Princeton.....	67
Zira.....	115
Zira Boardroom + Reception.....	282

METAL DESKS

StreamLINE.....	306
-----------------	-----

BENCHING

Bridges II.....	338
FreeFit Benching.....	415
Intelli Beam.....	484
Sidebar.....	434

PANELS + COMPONENTS

Divide.....	502
PRODUCTIVITY SOLUTIONS by Global	
Productivity Solutions.....	526
FOLI Height Adjustable Tables.....	528
FreeFit Height Adjustable Tables.....	663
Keyboard Trays.....	535
Manual Height Adjustable Tables.....	527
Monitor Arms.....	534
Office Accessories.....	540
Power/Data.....	524
Revo + Voyage Task Lights.....	539

TABLES - CAFE, MEETING + BOARDROOM

Alba tables.....	570
Boardroom tables.....	582
Kadin Tables.....	680
Swap tables.....	689
Zira Boardroom + Reception.....	282

TABLES - TRAINING

2gether tables.....	568
Bungee tables.....	603
Bungee SL tables.....	620
Bungee SL power/data management.....	627
ConnecTABLES.....	634
Junction.....	673
Terina.....	710

TABLES - RECEPTION + OCCASIONAL

Citi tables.....	728
Coat trees.....	729
Dawson tables.....	730
Laminate occasional tables.....	731
Lite Lift II folding tables.....	732
Sirena tables.....	733
Wind tables.....	734

TABLE OF CONTENTS

WORKPLACE

TABLE POWER + TECHNOLOGY SOLUTIONS

Table Power + Technology Solutions552

WELLNESS SOLUTIONS

Consultation Booth.....524

Linking Panels521

Wellness Screens518

REFERENCE

Custom Grommet Location Form.....745

Terms + Conditions.....752

Warranty.....754

Textiles + Finishes.....738

EDUCATION

CLASSROOM

2gether tables568

Bungee tables603

Bungee SL tables620

Bungee SL power/data management627

ConnectTABLES634

Duet tables.....650

CLASSROOM (cont'd)

Edventure653

Junction.....673

StreamLINE306

Terina.....710

Zook.....716



MEETING + COLLABORATIVE

Alba tables570





Kadin Tables680

Swap tables689

DESKING COMPARISON CHART

	ADAPTABILITIES	BRIDGES II	GENOA
			
GENERAL FEATURES	Top Over End Panel Design 400 Color Combinations Virtually No Loose Hardware Storage Height is 66" 2 Handle Options	Beam-Based Benching System 20+ Finishes Available 8-Wire, 4-Circuit Electrical Storage Height is 21", 25" and 29"	Top Over End Panel Design 3/4 Pedestal Standard Virtually No Loose Hardware Storage Height is 66"
GOOD BETTER BEST	Better	Best	Good
STYLE	Transitional	Contemporary	Transitional
PRICE POINT (36x72 Double Pedestal Desk)	\$1358	N/A	\$1034
WORKSURFACE THICKNESS	1"	1"	1"
SURFACE TYPE	High Performance Thermally Fused Laminate or HPL	High Performance Thermally Fused Laminate or HPL	High Performance Thermally Fused Laminate
EDGE THICKNESS	2mm	3mm	Self Edge
EDGE OPTIONS	Flat	N/A	N/A
HUTCH CLEARANCE (Worksurface to underside of hutch)	17.75" to Valance 20" to Underside of Hutch	N/A	20"
GREENGUARD CERTIFIED	Yes	Yes	Yes
BIFMA e3 LEVEL CERTIFIED	Level 3	Level 3	Level 3
USDA BIO-PREFERRED EDGING	Yes	No	Yes

DESKING COMPARISON CHART

	HALTON	PRINCETON	STREAMLINE	ZIRA
				
GENERAL FEATURES	Top Over End Panel Design 3/4 Pedestal Standard Virtually No Loose Hardware	Freestanding, modular components Overlapping architectural elements 13 standard finishes; up to 3 color application on many components available Optional 6mm tempered glass on hutches and desktop storage. Storage Height is 52" and 66"	Laminate Top over Steel End Panel / Storage Design. All Global Laminates available on top. Standard, Paints, Textured and Custom Paint Colors available on steel chassis.	Top Over End Panel Design 400 Color Combinations Virtually No Loose Hardware Storage Height is 42", 54", 66", 72" and 84" (nominal). 9 Handle Options 4 Glazing Options for storage doors and modesty panels.
GOOD BETTER BEST	Good	Best	Better	Best
STYLE	Transitional	Contemporary	Contemporary	Contemporary
PRICE POINT (36x72 Double Pedestal Desk)	\$1152	N/A	\$1954	\$1854
WORKSURFACE THICKNESS	1"	1"	1"	1" or 1.5"
SURFACE TYPE	High Performance Thermally Fused Laminate	High Performance Thermally Fused Laminate or HPL	High Performance Thermally Fused Laminate or HPL (upcharge)	High Performance Thermally Fused Laminate or HPL
EDGE THICKNESS	2mm	2mm	2mm	2mm
EDGE OPTIONS	N/A	N/A	N/A	Flat, Fluted or Bicut
HUTCH CLEARANCE (Worksurface to underside of hutch)	N/A	15.75"	24"	20.25" (23.5" Hutch) 17.75" (36" Hutch) 24.25" (42" Hutch) 24.25" (54" Hutch)
GREENGUARD CERTIFIED	Yes	Yes	Yes	Yes
BIFMA e3 LEVEL CERTIFIED	Level 3	Level 3	Level 2	Level 3
USDA BIO-PREFERRED EDGING	Yes	No	No	Yes

CONSUMER EDUCATION

How do I buy a desk?



Choose a non-reflective surface. Global uses colors that reduce glare to make your work easier to read while reducing eye strain.



Get a desk that lets you look ahead. A modular desk is easy to set up initially and then reorganize or reconfigure later to adapt to future needs.

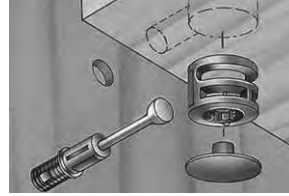

Look for European connectors if you're buying ready-to-assemble furniture. Global makes assembly easy - all you need is a screwdriver.



Give your business an edge. Each Global desk comes with its own attractive edge design.



Avoid tangles. Make sure your desk has at least one grommet hole to keep computer and telephone wires out of the way.



A hutch should have a sweep that manages computer and telephone wires.



Island worksurfaces let you meet with more than two people at once with ample leg room for all.



Choose one of Global's height/angle adjustable keyboard trays to go with your desk. Your arms can maintain a comfortable position, reducing shoulder, back and neck strain.

How do I select the right workstation?

When searching for the right workstation it is important to consider its purpose which will be decided by the nature of your tasks. It is best to look for products that have been designed and engineered to help make your workspace more productive.

This can be achieved in a variety of ways. As a guide, observe how your work flows through your office in a typical day. It is likely that you'll uncover a number of distinctive and repetitive task patterns.

Once these patterns have been identified, organize them according to their intended use and frequency of their use. Now you are ready to investigate the pertinent factors that will determine the workspace you eventually select.

Lighting - Protect yourself

- If you have to setup near a window make sure your computer sits perpendicular to it, minimize eye-strain inducing glare on sunny days.
- If you have fluorescent lights, try to position your set up between the lights.
- Use "Parabolic louvers" to reduce the glare from fluorescent lights
- Use window blinds to control the light source through the day
- Panels or screens may be used to control glare
- Protect your eyes from Ultraviolet A (UVA) and Ultraviolet B (UVB) by using an anti-glare screen

Noise

- Try to set up your office in a separate room if possible and away from the rest of the house

Chair

- Comfort is personal but should be part of the selection
- Seat pan design; deep and wide enough
- Rounded front edge (waterfall)
- Adjustable slope seat
- Able to adjust your chair, to obtain appropriate height
- Sit back in your chair, with your thighs parallel to the floor
- Place feet flat on the floor, a footlocker may be required

Footlocker

- A footlocker helps to prevent possible discomfort resulting from outstretched feet
- The rocking motion creates light activity in the legs and feet and will help stimulate muscles to improve overall circulation

Keyboard

- Has a palm rest
- Easily adjusts the angle of the keyboard
- Easily adjusts the keyboard height

Document Holder

- A curved back document holder reduces glare
- Position document holder in line with the monitor to reduce eyestrain

Monitor

- There should be a direct line from the center of monitor to the, "J" key on your keyboard which should line up with your belt buckle
- Position the monitor at arm's length
- Make sure that the top of your monitor screen is slightly below eye level
- A monitor stand may be used to achieve the desired height

Workstation

- Adequate space beneath the worksurface for your legs
- Depth of the worksurface depends on the task and equipment used to perform this responsibility
- Try to place tasks that are performed regularly within arm's reach
- Avoid unnecessary reaching and bending which leads to fatigue and possible muscle strains and can reduce efficiency
- Keep in mind other related tasks in your planning
- Establish your workflow then design the essential elements to meet your requirements

desking – laminate



Adaptabilities

9



Genoa

48



Halton

60



Princeton

67



Zira

115

LAMINATE DESK NOTES

The following applies to all series EXCEPT the Bridges II, Princeton and StreamLINE series.

For information on the Bridges II series, please refer to page 338, for the Princeton series, please refer to page 67 and for the Streamline II series, please refer to page 306.

- Outside and surface panels are made from 1" thick 45 lb. density particle board and covered on both sides with high performance thermally fused laminate. Modesty panels are 11/16" thick.
- **BOX AND FILE DRAWERS** use FULL EXTENSION STEEL BALL BEARING SLIDES for smooth action.
- **BOX AND FILE PEDESTALS** are standard and are CONSTRUCTED INDEPENDENTLY of the chassis, with fully closed bottoms. This PICTURE FRAME CONSTRUCTION technique prevents racking, and provides a product that lasts for years.
- **FILE DRAWERS** file both legal and letter documents as standard (LETTER FILES will file in BOTH DIRECTIONS, as will LATERAL FILES), except 15"w Zira units (side to side only).
- Drawers and END PANELS are **EDGE BANDED** on ALL FOUR SIDES to protect clothing and the floor covering.
- Locks are standard on all box and file pedestals, lateral files, storage cabinets and combination storage units.
- All locking components within each series can be keyed alike at no additional charge. Please specify the request at time of ordering.
- Drawers are opened with side pulls and are constructed 22" deep (Genoa and Halton 18"D) using French dovetail joints at the front and lap joints at the rear. Woodgrain enameled bottoms are routed into the woodgrain (MDF) sides on three edges.
- Full to the floor pedestal configurations can be switched for a **15% upcharge** (Adaptabilities and Halton series ONLY).
- Pencil tray included with each desk.
- **LEVELING GLIDES** are standard on ALL UNITS.
- All units are **shipped fully assembled** (except where noted) on 1" x 3" thick wood furniture skids with pedestal supports inside high quality cartons.
- **ALL "L" SHAPED DESKS** have flush backs on the return (modesty panels).
- Additional options available include (add suffix to item number):
FM = Full modesty panel. Available on any desk or credenza. **ADD \$55.** (Standard on Adaptabilities and Zira Series).
- Desks with FULL TO FLOOR pedestals CANNOT have ¾ modesty panels.
- Corners must have matching modesty panels (both sides must be either ¾ or full modesty panels).
- **Modesty panels** on CORNERS will be 1" above the floor; **Modesty panels** on RETURNS are flush with the floor. It is recommended that corner units are used for corner spaces when configuring workstations so there is no visible difference if a corner is connected to a return.
- Optional grommets are available. **SEE EACH SERIES** for details. **ADD \$69.**
- Global Furniture Group will consider custom, specials and product alterations on an individual basis.
- Desk series can only be made in **Standard Global Laminates**.
- **PLEASE REFER TO SERIES FOR FINISHES AVAILABLE.** The following desk finishes are offered:

WOODGRAINS:

Absolute Acajou (ACJ)	Asian Night (ASN)	Avant Cherry (AWC)
Avant Honey (AWH)	Clear Maple (CMB)	Dark Espresso (DES)
Quartered Mahogany (QTM)	Tiger Fruitwood (TFW)	Tiger Walnut (TWL)
Walnut Heights (WHE)	White Chocolate (WHC)	Winter Cherry (WCR)

SOLIDS:

Black (BLK)	Designer White (DWT)	Hayden Grey (HGT)
Storm Grey (SOG)	Willow Grey (WGY)	

PATTERNS:

Brushed Cobalt (BRC)

- See **Productivity Solutions** and **Desk Accessories** for additional options



With over 370 components available in 400 color combinations, Adaptabilities provides the ultimate in flexibility and modularity. Rich laminate colors coordinate easily with any office or home decor. All surfaces are constructed from Global's exclusive premium grade, high performance laminate and preferred matching edges.

Adaptabilities features an extensive range of versatile components which can be configured into multi-user workstations suitable for intensive task functions, or for private executive suites requiring stately elegance and work-force functions. All laminate filing cabinets have a safety mechanism that prevents two drawers from being opened at the same time. File drawers have fully progressive ball bearing suspensions and accommodate letter and legal filing. For heavy duty usage, two, three and four drawer laminate files are available with steel drawer interiors.



Tops are 1" thick and a top over side, edge panel design.



3/4 modesty panel available at no extra charge.



For heavy duty usage, two, three and four drawer laminate files are available with steel drawer interiors.



Features and Benefits

- 45lb. density particle board substructure with high performance thermally fused laminate
- 1" thick worksurfaces in thermally fused or high pressure laminate
- Worksurfaces feature 2mm edging in matching color.
- Full to floor or 3/4 pedestals available on most components
- All desks are size (incrementally) accurate
- 11/16" thick full modesty panel is standard
- 11/16" thick 3/4 modesty panel is available on most components
- Pencil tray included in box drawer
- File drawers can accommodate legal or letter documents
- Full progressive ball bearing suspension on file drawers
- All drawer fronts edge banded with side pull opening pedestals and standard with pedestal locks
- Compatible with **Divide** panel system for increased privacy and storage requirements

GENERAL INFORMATION

- Constructed of 45 lb. density particleboard with high performance thermally fused laminate
- Adaptabilities components are compatible with Divide transaction tops and partitioning panels. See page 502 for Divide specifications and prices.
- See pages 40-41 for keyboard drawers and additional accessory options.
- Adaptabilities desk and storage products have been tested and comply with all BIFMA mechanical tests.
- GREENGUARD INDOOR AIR QUALITY CERTIFICATION - Global laminate and seating products are in compliance with stringent emission guidelines set out by the Greenguard Environmental Institute under the standards for low emitting products and materials. www.greenguard.org.
- **Level 3 Certified**

WORKSURFACES

- 1" thick high performance thermally fused laminate tops sealed with Global's Preferred edging in matching color
- Woodgrain surfaces feature edging with matching printed woodgrain
- High Pressure Tops are available in all Adaptabilities laminate finishes at an extended lead time. Please see model # for pricing and availability.
- Products specified with the high pressure laminate option are finished on the underside of the surface with a kraft paper backing.

CONSTRUCTION

- Constructed of 45 lb. density particleboard with high performance thermally fused laminate.
- Cabinets and Wardrobes are 65" high to match overall height of a worksurface with hutch (worksurface 29" + hutch 36" = 65").
- End Shelves are available as 65" high also to match overall height.
- Models with monoposts are standard with a Black monopost; Silver is available at no charge, please specify as **SI**. The Silver finish will match the Silver finish used on Divide.
- Models with handles are standard with a Black handle; Silver is available at no charge, please specify as **SI**. The Silver finish will match the Silver finish used on Divide.
- All drawer fronts edge banded with side pull opening pedestals and standard pedestal locks
- Double wall pedestal housing with fully closed bottom

MODESTY PANELS

- 11/16" thick full modesty panel is standard
- 11/16" thick ¾ modesty panel available on most components
- ¾ height modesty panels available on most models at no additional charge. Please specify "**3MP**". (Corners must have both modesty panels as ¾ or full).
- **Note:** Woodgrain modesty panels over 60" wide will have the grain pattern in the horizontal direction. All end panels and modesty panels 60" or less will have the grain pattern in the vertical direction.

STORAGE

- All lateral file drawer fronts feature the woodgrain running in a horizontal direction.
- Pencil tray included in box drawer
- File drawers can accommodate legal or letter documents
- Triple progressive ball bearing suspension on file drawers

LOCKS

- Optional locks available for all straight hutch unit doors. Add **\$95** each lock
- Front-to-back filing bars for all steel drawer files available separately. Order FBB file bars. See "FBB" on page 41.

SPECIAL SIZES

- Additional custom sized components available upon request.
- Customer specified printer slots available in all worksurfaces. Contact Global Customer Service for pricing.
- Secretarial height returns (26 ½") available at a 15% upcharge.
- Full to the floor pedestal configurations can be switched for a 15% upcharge.

1. SPECIFY MODEL NUMBER

2. SPECIFY FINISH

One Tone Finishes:

ACJ	Absolute Acajou
ASN	Asian Night
AWC	Avant Cherry
AWH	Avant Honey
BLK	Black
BRC	Brushed Cobalt
CMB	Clear Maple
DES	Dark Espresso
DWT	Designer White
HGT	Hayden Grey
QTM	Quartered Mahogany
SOG	Storm Grey
TFW	Tiger Fruitwood
TWL	Tiger Walnut
WHE	Walnut Heights
WHC	White Chocolate
WGY	Willow Grey
WCR	Winter Cherry

Top Finishes:

ACJ	Absolute Acajou
ASN	Asian Night
AWC	Avant Cherry
AWH	Avant Honey
BLK	Black
BRC	Brushed Cobalt
CMB	Clear Maple
DES	Dark Espresso
DWT	Designer White
HGT	Hayden Grey
QTM	Quartered Mahogany
SOG	Storm Grey
TFW	Tiger Fruitwood
TWL	Tiger Walnut
WHE	Walnut Heights
WHC	White Chocolate
WGY	Willow Grey
WCR	Winter Cherry

Body Finishes (including pedestals):

ACJ	Absolute Acajou
ASN	Asian Night
AWC	Avant Cherry
AWH	Avant Honey
BLK	Black
BRC	Brushed Cobalt
CMB	Clear Maple
DES	Dark Espresso
DWT	Designer White
HGT	Hayden Grey
QTM	Quartered Mahogany
SOG	Storm Grey
TFW	Tiger Fruitwood
TWL	Tiger Walnut
WHE	Walnut Heights
WHC	White Chocolate
WGY	Willow Grey
WCR	Winter Cherry

3. SPECIFY OPTIONS

Grommets

- Additional grommets available in standard worksurface locations (left, center or right).
- Order as: **AG1, AG2 or AG3. Add \$69.**

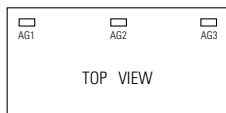

- Grommet hole dimensions are 3 1/4" wide x 1 7/8" deep.
- Actual grommet locations on the worksurface are depicted in the example drawings shown below. Dimensions shown are actual measurements (in inches).

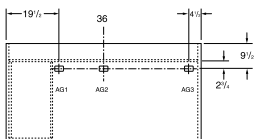

36 x 72 single pedestal left desks (A3672SPL)

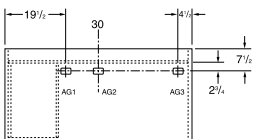

30 x 60 single pedestal left desks (A3060SPL)

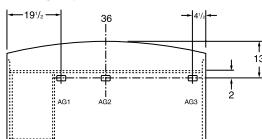

36 x 72 single pedestal left bow top desks (A3672SLB)

- Grommets may be placed at non-standard locations. Order as: **AGS - Add \$69.** A drawing must be supplied with vertical and horizontal dimensions to the center of the cut-out (as in drawing above). Please refer to CUSTOM GROMMET LOCATION FORM in the back reference section.
- Components that come standard with grommet may be ordered without a grommet. **Add \$37.**
- Grommets are available on modesty panels of extended corners and 5-sided corners 6 1/2" in where the two modesty panels meet at a 90° angle. Please specify FOGMPR for right grommet placement and FOGMPL for left grommet (placement is as shown on diagrams below). Cost is **\$69.**
- **Modesty panels are 1" off of ground**

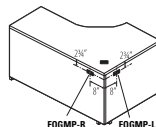

Left Extended Corner Unit

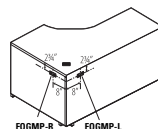

Right Extended Corner Unit

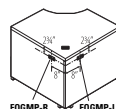

5-Sided Corner Unit

Power Block

- A Power Block (model PMSPDM) may be ordered on all worksurfaces.
- A Power Block is a rectangular worksurface power/data module with one electrical duplex receptacle and includes two data (CAT5) receptacles. 9 foot black cord included. Power Block dimensions are 3 1/2" deep x 6 1/2" wide x 2 3/4" high.
- To purchase a Power Block, you must specify both the Power Block cut-out location and the Power Block model #. Order Power Block as **PMSPDM, Add \$261.** Power Blocks are available in standard worksurface locations (left, center or right). Order as **E1, E2 or E3. Add \$69.**



Power Block **PMSPDM Add \$261**

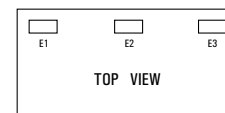

Specify location **E1, E2 or E3 Add \$69**

A ADAPTABILITIES®

DOUBLE PEDESTAL DESKS

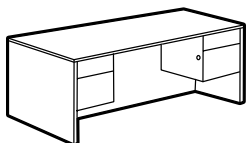

Double Pedestal Desk

MODEL#	DIMENSIONS D x W x H	FREIGHT CLASS	WT./LBS.	CUBIC FT.	LIST PRICE	HP ADD
A3672DP	36 x 72 x 29.5	150	296	52.50	\$1358	\$399
A3072DP	29.69 x 72 x 29.5	125	263	43	\$1334	\$373
A3066DP	29.69 x 66 x 29.5	125	254	39.75	\$1322	\$373
A3060DP	29.69 x 60 x 29.5	125	247	36.25	\$1207	\$347

Standard with box/file pedestals on both sides. Pedestals lock. One pencil tray.

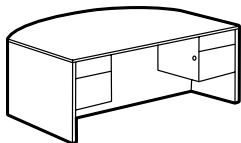

Double Pedestal Bow Top Desk

A3672DPB	30-36 x 72 x 29.5	150	280	52.50	\$1618	\$399
----------	-------------------	-----	-----	-------	---------------	--------------

Standard with box/file pedestals on both sides and bow top. Pedestals lock. One pencil tray.

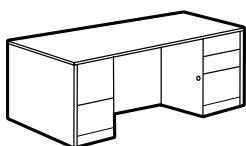

Full to Floor Double Pedestal Desk

A3672D4	36 x 72 x 29.5	125	330	52.50	\$1730	\$399
A3072D4	30 x 72 x 29.5	125	295	41.15	\$1700	\$399
A3066D4	29.69 x 66 x 29.5	125	285	39.75	\$1693	\$373
A3060D4	29.69 x 60 x 29.5	125	276	36.25	\$1577	\$347

Standard with full to floor box/box/file in right pedestal and file/file on left pedestal. Pedestals lock. On box/box/file pedestals, lower box drawer and file drawer lock. One pencil tray. Full to the floor pedestal configurations can be switched for a **15% upcharge**.

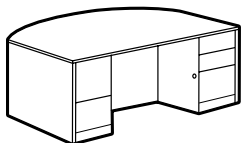

Full to Floor Double Pedestal Bow Top Desk

A3672DB4	32-36 x 72 x 29.5	150	311	52.50	\$1988	\$399
----------	-------------------	-----	-----	-------	---------------	--------------

Standard with full to floor box/box/file in right pedestal and file/file on left pedestal. Bow top. Pedestals lock. On box/box/file pedestals, lower box drawer and file drawer lock. One pencil tray. Full to the floor pedestal configurations can be switched for a **15% upcharge**.

SINGLE PEDESTAL DESKS

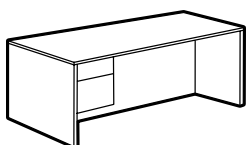

Single Pedestal Desk - LEFT

MODEL#	DIMENSIONS	FREIGHT CLASS	WT./LBS.	CUBIC FT.	LIST PRICE	HP ADD
A3672SPL	36 x 72 x 29.5	150	245	52.50	\$1133	\$399
A3072SPL	29.69 x 72 x 29.5	150	216	43	\$995	\$373
A3066SPL	29.69 x 66 x 29.5	150	207	39.75	\$982	\$373
A3060SPL	29.69 x 60 x 29.5	150	197	36.25	\$978	\$347
A3048SPL	29.69 x 48 x 29.5	125	177	29.25	\$878	\$294
A2448SPL	24 x 48 x 29.5	125	150	24.25	\$878	\$191

Standard with box/file pedestal. Pedestal locks. One pencil tray. Pedestal is on the **left**.

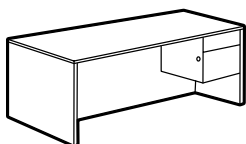

Single Pedestal Desk - RIGHT

A3672SPR	36 x 72 x 29.5	150	245	52.50	\$1133	\$399
A3072SPR	29.69 x 72 x 29.5	150	216	43	\$995	\$373
A3066SPR	29.69 x 66 x 29.5	150	207	39.75	\$982	\$373
A3060SPR	29.69 x 60 x 29.5	150	197	36.25	\$978	\$347
A3048SPR	29.69 x 48 x 29.5	125	177	29.25	\$878	\$294
A2448SPR	24 x 48 x 29.5	125	150	24.25	\$878	\$191

Standard with box/file pedestal. Pedestal locks. One pencil tray. Pedestal is on the **right**.

Required Specifications

Top finish
Base finish

Optional Specifications

Key #
Grommet/power block cut-out
HP laminate
Modesty panel

Accessories

Power block
Keyboard tray
Pencil tray

SINGLE PEDESTAL DESKS

MODEL# DIMENSIONS FREIGHT CLASS WT/LBS. CUBIC FT. LIST PRICE HP ADD

D x W x H

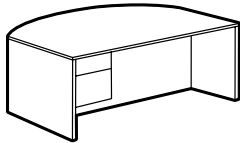

Single Pedestal Bow Top Desk - LEFT

A3672SLB 30-36 x 72 x 29.5 150 233 52.50 **\$1387 \$399**

Standard with box/file pedestal on **left** and bow top. Pedestal locks. One pencil tray.

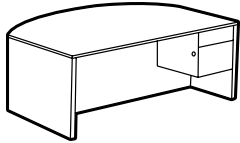

Single Pedestal Bow Top Desk - RIGHT

A3672SRB 30-36 x 72 x 29.5 150 233 52.50 **\$1387 \$399**

Standard with box/file pedestal on **right** and bow top. Pedestal locks. One pencil tray.

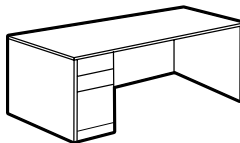

Full to Floor Single Pedestal Desk - LEFT

A3672S4L	36 x 72 x 29.5	150	261	52.50	\$1319	\$399
A3072S4L	29.69 x 72 x 29.5	150	232	43.75	\$1288	\$399
A3066S4L	29.69 x 66 x 29.5	150	221	39.50	\$1279	\$373
A3060S4L	29.69 x 60 x 29.5	150	211	36.25	\$1160	\$347
A3048S4L	29.69 x 48 x 29.5	125	191	29.50	\$1022	\$294
A2448S4L	24 x 48 x 29.5	125	164	24.25	\$1022	\$191

Standard with full to floor box/box/file pedestal on the **left**. One pencil tray. Lower box drawer and file drawer lock. Full to the floor pedestal configurations can be switched for a **15% upcharge**.

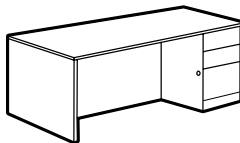

Full to Floor Single Pedestal Desk - RIGHT

A3672S4R	36 x 72 x 29.5	150	261	52.50	\$1319	\$399
A3072S4R	29.69 x 72 x 29.5	150	232	43.75	\$1288	\$399
A3066S4R	29.69 x 66 x 29.5	150	221	39.75	\$1279	\$373
A3060S4R	29.69 x 60 x 29.5	150	211	36.25	\$1160	\$347
A3048S4R	29.69 x 48 x 29.5	125	191	29.50	\$1022	\$294
A2448S4R	24 x 48 x 29.5	125	164	24.25	\$1022	\$191

Standard with full to floor box/box/file pedestal on the **right**. One pencil tray. Lower box drawer and file drawer lock. Full to the floor pedestal configurations can be switched for a **15% upcharge**.

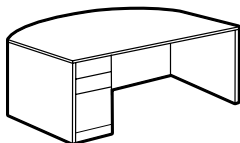

Full to Floor Single Pedestal Bow Top Desk - LEFT

A3672S4LB 32-36 x 72 x 29.5 150 247 52.50 **\$1573 \$399**

Standard with box/box/file pedestal on **left** and bow top. One pencil tray. Lower box drawer and file drawer lock. One pencil tray. Full to the floor pedestal configurations can be switched for a **15% upcharge**.

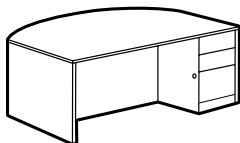

Full to Floor Single Pedestal Bow Top Desk - RIGHT

A3672S4RB 32-36 x 72 x 29.5 150 247 52.50 **\$1573 \$399**

Standard with box/box/file pedestal on **right** and bow top. One pencil tray. Lower box drawer and file drawer lock. One pencil tray. Full to the floor pedestal configurations can be switched for a **15% upcharge**.

Required Specifications

Top finish
Base finish

Optional Specifications

Key #
Grommet/power block cut-out
HP laminate
Modesty panel

Accessories

Power block
Keyboard tray
Pencil tray

RETURNS

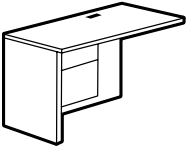

Flush Return - LEFT

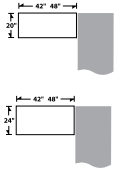

MODEL#	DIMENSIONS D x W x H	FREIGHT CLASS	WT/LBS.	CUBIC FT.	LIST PRICE	HP ADD
A2448FL	24 x 48 x 29.5	150	141	24	\$828	\$203
A2442FL	24 x 42 x 29.5	125	131	21.25	\$811	\$170
A2048FL	20 x 48 x 29.5	125	128	20.25	\$778	\$170
A2042FL	20 x 42 x 29.5	125	119	18	\$763	\$170

Standard with box/file drawer pedestal. One pencil tray. Pedestal locks. Grommet in worksurface. Pedestal is on the **left**.

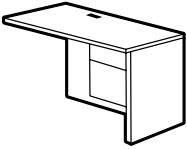

Flush Return - RIGHT

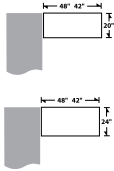

A2448FR	24 x 48 x 29.5	150	141	24	\$828	\$203
A2442FR	24 x 42 x 29.5	125	131	21.25	\$811	\$170
A2048FR	20 x 48 x 29.5	125	128	20.25	\$778	\$170
A2042FR	20 x 42 x 29.5	125	119	18	\$763	\$170

Standard with box/file drawer pedestal. One pencil tray. Pedestal locks. Grommet in worksurface. Pedestal is on the **right**.

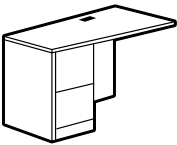

Full to Floor Flush Return - LEFT

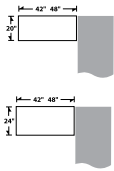

A2448L4	24 x 48 x 29.5	125	156	24.25	\$1013	\$203
A2442L4	24 x 42 x 29.5	125	146	21.50	\$998	\$170
A2048L4	20 x 48 x 29.5	125	142	20.50	\$964	\$170
A2042L4	20 x 42 x 29.5	125	133	18	\$949	\$170

Standard with file/file drawer pedestal. One pencil tray. Pedestal locks. Grommet in worksurface. Pedestal is on the **left**. Full to the floor pedestal configurations can be switched for a **15% upcharge**.

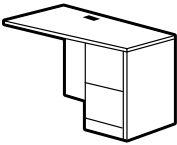

Full to Floor Flush Return - RIGHT

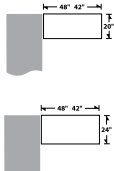

A2448R4	24 x 48 x 29.5	125	156	24.25	\$1013	\$203
A2442R4	24 x 42 x 29.5	125	146	21.50	\$998	\$170
A2048R4	20 x 48 x 29.5	125	142	20.50	\$964	\$170
A2042R4	20 x 42 x 29.5	125	133	18	\$949	\$170

Standard with file/file drawer pedestal. One pencil tray. Pedestal locks. Grommet in worksurface. Pedestal is on the **right**. Full to the floor pedestal configurations can be switched for a **15% upcharge**.

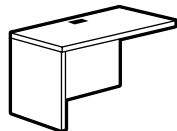

Flush Return - LEFT

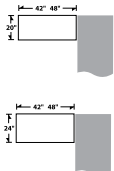

A2448EL	24 x 48 x 29.5	70	92	4.30	\$600	\$203
A2442EL	24 x 42 x 29.5	70	82	3.80	\$580	\$170
A2048EL	20 x 48 x 29.5	70	84	4.30	\$547	\$170
A2042EL	20 x 42 x 29.5	70	75	3.80	\$533	\$170

Return has no pedestal. Grommet in worksurface. Shipped RTA (ready to assemble).

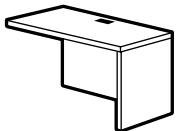

Flush Return - RIGHT

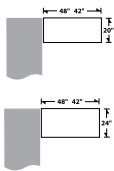

A2448ER	24 x 48 x 29.5	70	92	4.30	\$600	\$203
A2442ER	24 x 42 x 29.5	70	82	3.80	\$580	\$170
A2048ER	20 x 48 x 29.5	70	84	4.30	\$547	\$170
A2042ER	20 x 42 x 29.5	70	75	3.80	\$533	\$170

Return has no pedestal. Grommet in worksurface. Shipped RTA (ready to assemble).

Required Specifications

Top finish
Base finish

Optional Specifications

Key #*
Grommet/power block cut-out
HP laminate

Accessories

Power block
Keyboard tray
Pencil tray

RETURNS

MODEL# DIMENSIONS FREIGHT CLASS WT/LBS. CUBIC FT. LIST PRICE HP ADD

D x W x H

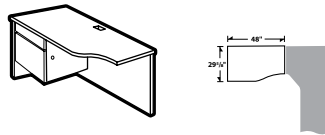

Space Saver Return - LEFT

A3048FSL 29.69 x 48 x 29.5 150 148 29 \$878 \$294

Standard with box/file pedestal on the **left**, grommet in worksurface. One pencil tray. Pedestal locks. Connects to 24"D 5-sided corner unit and 2466/2472 NFL or NNL extended corner unit.

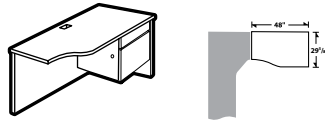

Space Saver Return - RIGHT

A3048FSR 29.69 x 48 x 29.5 150 148 29 \$878 \$294

Standard with box/file pedestal on the **right**, grommet in worksurface. One pencil tray. Pedestal locks. Connects to 24"D 5-sided corner unit and 2466/2472 FNR or NNR extended corner unit.

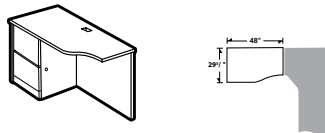

Space Saver Return - LEFT

A3048P4L 29.69 x 48 x 29.5 150 170 29 \$1062 \$294

Standard with file/file pedestal on the **left**, grommet in worksurface. One pencil tray. Pedestal locks. Connects to 24"D 5-sided corner unit and 2466/2472 NFL or NNL extended corner unit. Full to the floor pedestal configurations can be switched for a **15% upcharge**.



Space Saver Return - RIGHT

A3048P4R 29.69 x 48 x 29.5 150 170 29 \$1062 \$294

Standard with file/file pedestal on the **right**, grommet in worksurface. One pencil tray. Pedestal locks. Connects to 24"D 5-sided corner unit and 2466/2472 FNR or NNR extended corner unit. Full to the floor pedestal configurations can be switched for a **15% upcharge**.

FLUSH BRIDGE

MODEL# DIMENSIONS FREIGHT CLASS WT/LBS. CUBIC FT. LIST PRICE HP ADD

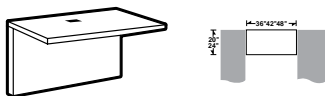

Flush Bridge*

A2448FB	24 x 48 x 29.5	70	75	4.30	\$451	\$203
A2442FB	24 x 42 x 29.5	70	65	3.80	\$433	\$170
A2436FB	24 x 36 x 29.5	70	58	3.30	\$433	\$128
A2048FB	20 x 48 x 29.5	70	71	4.30	\$433	\$170
A2042FB	20 x 42 x 29.5	70	54	3.30	\$416	\$170
A2036FB	20 x 36 x 29.5	70	54	3.30	\$416	\$86

Top surface, back panel and hardware to connect two units. Grommet in worksurface. Shipped RTA (ready to assemble).

CREDENZAS

MODEL# DIMENSIONS FREIGHT CLASS WT/LBS. CUBIC FT. LIST PRICE HP ADD

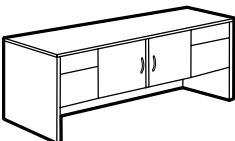

Center Storage Credenza

A2072C 20 x 72 x 29.5 100 243 30 \$1633 \$266

Standard with box/file pedestals on both sides and self-closing hinged center doors covering one adjustable shelf. Pedestals and doors lock. One pencil tray.

Required Specifications

Top finish
Base finish
Handles**

Optional Specifications

Key #
Additional grommet position (not A2072C)
HP laminate
Power block cut-out (not A2072C)

Accessories

Power block
Keyboard tray*
Pencil tray*

A ADAPTABILITIES®

CREDENZAS

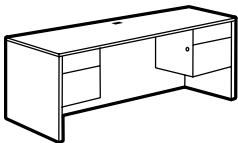

Kneespace Credenza

MODEL#	DIMENSIONS D x W x H	FREIGHT CLASS	WT./LBS.	CUBIC FT.	LIST PRICE	HP ADD
A2472CK	24 x 72 x 29.5	125	234	35.75	\$1365	\$278
A2466CK	24 x 66 x 29.5	125	225	32.75	\$1326	\$278
A2072CK	20 x 72 x 29.5	125	212	30.25	\$1248	\$266
A2066CK	20 x 66 x 29.5	125	204	27.75	\$1229	\$256
A2060CK	20 x 60 x 29.5	125	199	25.25	\$1198	\$235

Standard with box/file pedestals on both sides. Center is open. Pedestals lock. One pencil tray. Grommet in worksurface.

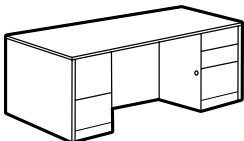

Full to Floor Kneespace Credenza

A2472D4	24 x 72 x 29.5	125	261	35.50	\$1731	\$278
A2466D4	24 x 66 x 29.5	125	252	33	\$1694	\$278
A2072D4	20 x 72 x 29.5	125	236	30	\$1618	\$266
A2066D4	20 x 66 x 29.5	100	228	27.75	\$1601	\$256
A2060D4	20 x 60 x 29.5	100	220	25.25	\$1593	\$235

Standard with full to floor box/box/file in right pedestal and file/file on left pedestal. Pedestals lock on box/box/file pedestals, lower box drawer and file drawer lock. One pencil tray. Grommet in worksurface.

- Full to the floor pedestal configurations can be switched for a **15% upcharge**.

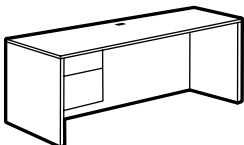

Single Pedestal Credenza - LEFT

A2472CSL	24 x 72 x 29.5	150	190	35.75	\$1157	\$278
A2466CSL	24 x 66 x 29.5	150	181	32.75	\$1118	\$278
A2072CSL	20 x 72 x 29.5	150	172	30.25	\$1043	\$266
A2066CSL	20 x 66 x 29.5	150	163	27.75	\$1026	\$256
A2060CSL	20 x 60 x 29.5	125	155	25.25	\$992	\$235

Standard with box/file pedestal. Pedestal locks. One pencil tray. Pedestal is on the **left**. Grommet in worksurface.

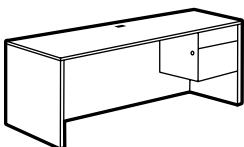

Single Pedestal Credenza - RIGHT

A2472CSR	24 x 72 x 29.5	150	190	35.75	\$1157	\$278
A2466CSR	24 x 66 x 29.5	150	181	32.75	\$1118	\$278
A2072CSR	20 x 72 x 29.5	150	171	30	\$1043	\$266
A2066CSR	20 x 66 x 29.5	150	163	27.75	\$1026	\$256
A2060CSR	20 x 60 x 29.5	125	155	25.25	\$992	\$235

Standard with box/file pedestal. Pedestal locks. One pencil tray. Pedestal is on the **right**. Grommet in worksurface.

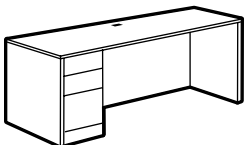

Full to Floor Single Pedestal Credenza - LEFT

A2472S4L	24 x 72 x 29.5	150	205	35.50	\$1319	\$278
A2466S4L	24 x 66 x 29.5	150	196	33	\$1279	\$278
A2072S4L	20 x 72 x 29.5	125	187	30	\$1160	\$266
A2066S4L	20 x 66 x 29.5	125	177	27.75	\$1139	\$266
A2060S4L	20 x 60 x 29.5	125	168	25.25	\$1110	\$235

Standard with full to floor box/box/file pedestal on the **left**. Lower box drawer and file drawer lock. Grommet in worksurface. One pencil tray.

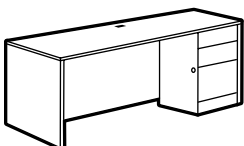

Full to Floor Single Pedestal Credenza - RIGHT

A2472S4R	24 x 72 x 29.5	150	205	35.50	\$1319	\$278
A2466S4R	24 x 66 x 29.5	150	196	33	\$1279	\$278
A2072S4R	20 x 72 x 29.5	125	187	30	\$1160	\$266
A2066S4R	20 x 66 x 29.5	125	177	27.75	\$1139	\$266
A2060S4R	20 x 60 x 29.5	125	168	25.25	\$1110	\$235

Standard with full to floor box/box/file pedestal on the **right**. Lower box drawer and file drawer lock. Grommet in worksurface. One pencil tray.

Required Specifications

Top finish
Base finish

Optional Specifications

Key #
Grommet/power block cut-out
HP laminate

Accessories

Power block
Keyboard tray
Pencil tray

CREDENZAS

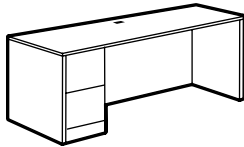

Full to Floor Single Pedestal Credenza- LEFT*

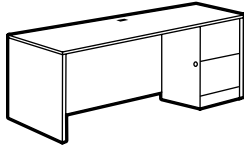

Full to Floor Single Pedestal Credenza- RIGHT*

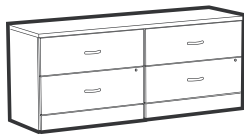

Lateral File Credenza

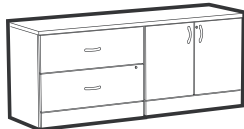

Lateral File/Storage Cabinet Credenza



Kneespace Lateral File Credenza - LEFT*



Kneespace Lateral File Credenza - RIGHT*

MODEL#	DIMENSIONS	FREIGHT CLASS	WT./LBS.	CUBIC FT.	LIST PRICE	HP ADD
--------	------------	---------------	----------	-----------	------------	--------

D x W x H

A2472S2L	24 x 72 x 29.5	150	205	35.50	\$1319	\$278
A2466S2L	24 x 66 x 29.5	150	196	33	\$1279	\$278
A2072S2L	20 x 72 x 29.5	125	187	30	\$1160	\$266
A2066S2L	20 x 66 x 29.5	125	177	27.75	\$1139	\$266
A2060S2L	20 x 60 x 29.5	125	168	25.25	\$1110	\$235

Standard with full to floor file/file pedestal on the **left**. Pedestal Locks. Grommet in worksurface.

A2472S2R	24 x 72 x 29.5	150	205	35.50	\$1319	\$278
A2466S2R	24 x 66 x 29.5	150	196	33	\$1279	\$278
A2072S2R	20 x 72 x 29.5	125	187	30	\$1160	\$266
A2066S2R	20 x 66 x 29.5	125	177	27.75	\$1139	\$266
A2060S2R	20 x 60 x 29.5	125	168	25.25	\$1110	\$235

Standard with full to floor file/file pedestal on the **right**. Pedestal locks. Grommet in worksurface.

A2472LF2	24 x 72 x 29.5	100	322	35.75	\$1995	\$278
A2072LF2	20 x 72 x 29.5	100	296	30.25	\$1954	\$266

Two 2-drawer lateral files side-by-side. Locking drawers, keyed alike. File bars included for side-to-side and front-to-back letter/legal filing capability. Anti-lock tilt suspension.

- Black handles are standard. Silver is available at no charge, please specify as **SI**.
- *File drawer construction is for accommodating hanging files NOT for stacking materials on the drawer bottom.*

A2472LS	24 x 72 x 29.5	100	297	35.75	\$1785	\$278
A2072LS	20 x 72 x 29.5	100	267	30.25	\$1744	\$266

One 2-drawer lateral file and one storage cabinet. Locking doors/drawers, keyed alike. Storage cabinet includes one adjustable shelf. File bars included for side-to-side and front-to-back letter/legal filing capability. Anti-lock tilt suspension.

- Black handles are standard. Silver is available at no charge, please specify as **SI**.
- *File drawer construction is for accommodating hanging files NOT for stacking materials on the drawer bottom.*

A2472LKL	24 x 72 x 29.5	125	239	35.75	\$1568	\$278
A2072LKL	20 x 72 x 29.5	125	216	30.25	\$1528	\$266

One 2-drawer lateral file on the **left**. Locking drawers. File bars included for side-to-side and front-to-back letter/legal filing capability. Anti-lock tilt suspension. Grommet in worksurface.

- Black handles are standard. Silver is available at no charge, please specify as **SI**.
- *File drawer construction is for accommodating hanging files NOT for stacking materials on the drawer bottom.*

A2472LKR	24 x 72 x 29.5	125	239	35.75	\$1568	\$278
A2072LKR	20 x 72 x 29.5	125	216	30.25	\$1528	\$266

One 2-drawer lateral file on the **right**. Locking drawers. File bars included for side-to-side and front-to-back letter/legal filing capability. Anti-lock tilt suspension. Grommet in worksurface.

- Black handles are standard. Silver is available at no charge, please specify as **SI**.
- *File drawer construction is for accommodating hanging files NOT for stacking materials on the drawer bottom.*

Required Specifications

Top finish
Base finish
Handles (not A2xxxS2L/A2xxxS2R)

Optional Specifications

Key #
Additional grommet
HP laminate
Power block cut-out*

Accessories

Power block*
Keyboard tray*
Pencil tray*

CREDENZAS

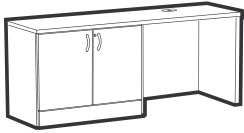

Kneespace Storage Cabinet Credenza - LEFT*

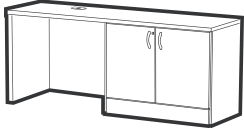

Kneespace Storage Cabinet Credenza - RIGHT*

MODEL#	DIMENSIONS	FREIGHT CLASS	WT/LBS.	CUBIC FT.	LIST PRICE	HP ADD
--------	------------	---------------	---------	-----------	------------	--------

D x W x H

A2472SKL	24 x 72 x 29.5	125	218	35.75	\$1238	\$278
A2072SKL	20 x 72 x 29.5	125	188	30.25	\$1197	\$266

One storage cabinet on the **left**. Locking doors. Storage cabinet has one adjustable shelf. Grommet in worksurface.

- Black handles are standard. Silver is available at no charge, please specify as **SI**.

A2472SKR	24 x 72 x 29.5	125	218	35.75	\$1238	\$278
A2072SKR	20 x 72 x 29.5	125	188	30.25	\$1197	\$266

One storage cabinet on the **right**. Locking doors. Storage cabinet has one adjustable shelf. Grommet in worksurface.

- Black handles are standard. Silver is available at no charge, please specify as **SI**.

5-SIDED CORNERS

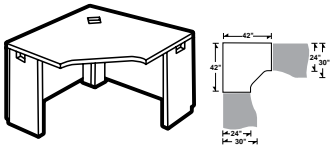

5-Sided Corner

MODEL#	DIMENSIONS	FREIGHT CLASS	WT/LBS.	CUBIC FT.	LIST PRICE	HP ADD
--------	------------	---------------	---------	-----------	------------	--------

A42245C	42 x 42 x 29.5	70	113	5.75	\$775	\$373
---------	----------------	----	-----	------	--------------	--------------

Connects to **30" D** space saver connectable surfaces, **24" D** connectables, returns and bridge. Grommet in worksurface.

Narrow end panels on left and right. Predrilled to accept 22" keyboard trays. **Will not accept keyboard trays wider than 22"**. Shipped RTA (ready to assemble). *Not Freestanding*.

- **Modesty Panel is 1" off of ground.**
- Full End Panel(s) are available - add **15% upcharge**

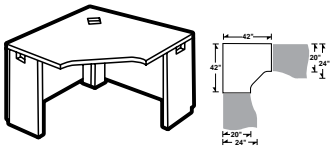

5-Sided Corner

A42205C	42 x 42 x 29.5	70	110	5.75	\$751	\$373
---------	----------------	----	-----	------	--------------	--------------

Connects to **24" D** space saver connectable surfaces, **20" D** returns, lateral files, storage/lateral file credenzas, credenzas, bridges and end shelves. Grommet in worksurface. Narrow end panels on left and right. Predrilled to accept 22-28" keyboard trays. **Will not accept keyboard trays wider than 28"**. Shipped RTA (ready to assemble). *Not freestanding*.

Will not accept keyboard trays wider than 28". Shipped RTA (ready to assemble). *Not freestanding*.

- **Modesty Panel is 1" off of ground.**
- Full End Panel(s) are available - add **15% upcharge**

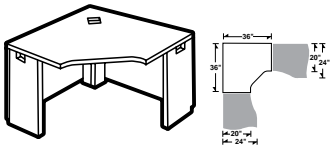

5-Sided Corner

A36205C	36 x 36 x 29.5	70	94	4.80	\$665	\$240
---------	----------------	----	----	------	--------------	--------------

Connects to **24" D** space saver connectable surfaces, **20" D** returns, lateral files, storage/lateral file credenzas, credenzas, bridges and end shelves. Grommet in worksurface. Narrow end panels on left and right. Predrilled to accept 22" keyboard trays. **Will not accept keyboard trays wider than 22"**. Shipped RTA (ready to assemble). *Not freestanding*.

Will not accept keyboard trays wider than 22". Shipped RTA (ready to assemble). *Not freestanding*.

- **Modesty Panel is 1" off of ground.**
- Full End Panel(s) are available - add **15% upcharge**

Required Specifications

Top finish
Base finish
Handles*

Optional Specifications

Key #
Additional grommet position
HP laminate
Power block cut-out

Accessories

Power block
Keyboard tray
Pencil tray

LEFT EXTENDED CORNERS

MODEL# DIMENSIONS FREIGHT CLASS WT/LBS. CUBIC FT. LIST PRICE HP ADD

D x W x H

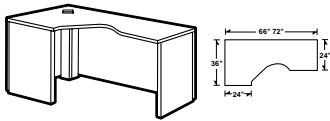

Left Extended Corner - Freestanding

A2472FFL	24-36 x 72 x 29.5	70	157	7	\$995	\$399
A2466FFL	24-36 x 66 x 29.5	70	151	7	\$995	\$399

Extended worksurface on right. **Full end panels on left and right. Cannot be connected on left or right, due to full end panel.** Corner has one grommet. Predrilled to accept 22" keyboard trays. **Will not accept keyboard trays wider than 22".** Shipped RTA (ready to assemble).

- **Modesty Panel is 1" off of ground.**
- **A2466FFL cannot accept pedestals.**

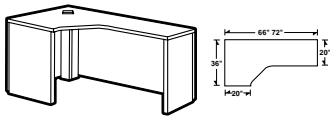

Left Extended Corner

A2072FFL	20-36 x 72 x 29.5	70	147	7	\$951	\$383
A2066FFL	20-36 x 66 x 29.5	70	141	7	\$951	\$383

Extended worksurface on right. **Full end panels on left and right. Cannot be connected on left or right, due to full end panel.** Corner has one grommet. Predrilled to accept 22" keyboard trays. **Will not accept keyboard trays wider than 22".** Shipped RTA (ready to assemble).

- **Modesty Panel is 1" off of ground.**

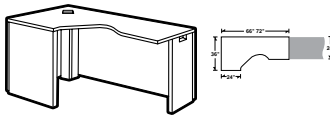

Left Extended Corner

A2472FNL	24-36 x 72 x 29.5	70	149	7	\$963	\$399
A2466FNL	24-36 x 66 x 29.5	70	142	7	\$963	\$399

Extended worksurface on right. **Narrow end panel on right. Full end panel on left.** Connects to 30"D space saver connectables, 24"D returns or 24"D connectable tables. **Full end panel cannot be connected.** Corner has one grommet. Predrilled to accept 22" keyboard trays. **Will not accept keyboard trays wider than 22".** Shipped RTA (ready to assemble).

- **Modesty Panel is 1" off of ground.**
- **A2466FNL cannot accept pedestals.**

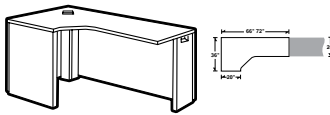

Left Extended Corner

A2072FNL	20-36 x 72 x 29.5	70	141	7	\$917	\$383
A2066FNL	20-36 x 66 x 29.5	70	135	7	\$917	\$383

Extended worksurface on right. **Narrow end panel on right. Full end panel on left.** Connects to 24"D space saver connectables, 20"D returns or 24"D connectable tables. **Full end panel cannot be connected.** Corner has one grommet. Predrilled to accept 22" keyboard trays. **Will not accept keyboard trays wider than 22".** Shipped RTA (ready to assemble).

- **Modesty Panel is 1" off of ground.**

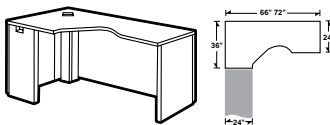

Left Extended Corner

A2472NFL	24-36 x 72 x 29.5	70	149	7	\$963	\$399
A2466NFL	24-36 x 66 x 29.5	70	142	7	\$963	\$399

Extended worksurface on right. **Narrow end panel on left. Full end panel on right.** Connects to 30"D space saver connectables, 24"D returns or 24"D connectable tables. **Full end panel cannot be connected.** Corner has one grommet. Predrilled to accept 22" keyboard trays. **Will not accept keyboard trays wider than 22".** Shipped RTA (ready to assemble).

- **Modesty Panel is 1" off of ground.**
- **A2466NFL cannot accept pedestals.**

Required Specifications

Top finish
Base finish

Optional Specifications

Additional grommet position
HP laminate
Power block cut-out

Accessories

Power block
Keyboard tray
Pencil tray

LEFT EXTENDED CORNERS

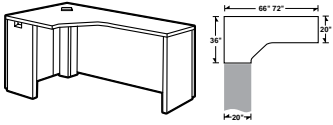

Left Extended Corner

MODEL#	DIMENSIONS	FREIGHT CLASS	WT/LBS.	CUBIC FT.	LIST PRICE	HP ADD
	D x W x H					
A2072NFL	20-36 x 72 x 29.5	70	141	7	\$917	\$399
A2066NFL	20-36 x 66 x 29.5	70	135	7	\$917	\$383

Extended worksurface on right. **Narrow end panel on left. Full end panel on right.** Connects to 24"D space saver connectables and 20"D returns. **Full end panel cannot be connected.** Corner has one grommet. Predrilled to accept 22" keyboard trays. **Will not accept keyboard trays wider than 22"**. Shipped RTA (ready to assemble).

- Modesty Panel is 1" off of ground.

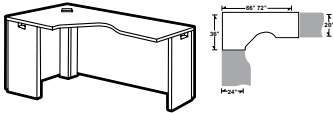

Left Extended Corner

A2472NNL	24-36 x 72 x 29.5	70	140	7	\$931	\$399
A2466NNL	24-36 x 66 x 29.5	70	134	7	\$931	\$399

Extended worksurface on right. **Narrow end panels on left and right.** Connects to 30"D space saver connectables, 24"D returns and 24"D connectable tables on either end. Corner has one grommet. Predrilled to accept 22" keyboard trays. **Will not accept keyboard trays wider than 22"**. Shipped RTA (ready to assemble).

- Modesty Panel is 1" off of ground.
- **A2466NNL** cannot accept pedestals.

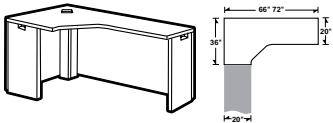

Left Extended Corner

A2072NNL	20-36 x 72 x 29.5	70	136	7	\$905	\$399
A2066NNL	20-36 x 66 x 29.5	70	130	7	\$905	\$383

Extended worksurface on right. **Narrow end panels on left and right.** Connects to 24"D space saver connectables and 20"D returns or bridge on either end. Corner has one grommet. Predrilled to accept 22" keyboard trays. **Will not accept keyboard trays wider than 22"**. Shipped RTA (ready to assemble).

- Modesty Panel is 1" off of ground.

RIGHT EXTENDED CORNERS

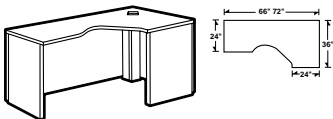

Right Extended Corner - Freestanding

MODEL#	DIMENSIONS	FREIGHT CLASS	WT/LBS.	CUBIC FT.	LIST PRICE	HP ADD
A2472FFR	24-36 x 72 x 29.5	70	157	7	\$995	\$399
A2466FFR	24-36 x 66 x 29.5	70	151	7	\$995	\$399

Extended worksurface on left. **Full end panels on left and right. Cannot be connected on left or right, due to full end panel.** Corner has one grommet. Predrilled to accept 22" keyboard trays. **Will not accept keyboard trays wider than 22"**. Shipped RTA (ready to assemble).

- Modesty Panel is 1" off of ground.
- **A2466FFR** cannot accept pedestals.

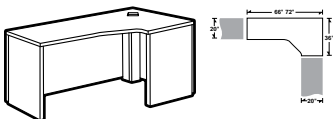

Right Extended Corner

A2072FFR	20-36 x 72 x 29.5	70	147	7	\$951	\$383
A2066FFR	20-36 x 66 x 29.5	70	141	7	\$951	\$383

Extended worksurface on left. **Full end panels on left and right. Cannot be connected on left or right, due to full end panel.** Corner has one grommet. Predrilled to accept 22" keyboard trays. **Will not accept keyboard trays wider than 22"**. Shipped RTA (ready to assemble).

- Modesty Panel is 1" off of ground.

Required Specifications

Top finish
Base finish

Optional Specifications

Additional grommet position
HP laminate
Power block cut-out

Accessories

Power block
Keyboard tray
Pencil tray

RIGHT EXTENDED CORNERS

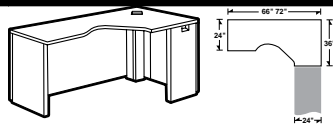

Right Extended Corner

MODEL#	DIMENSIONS	FREIGHT CLASS	WT./LBS.	CUBIC FT.	LIST PRICE	HP ADD
D x W x H						
A2472FNR	24-36 x 72 x 29.5	70	149	7	\$963	\$399
A2466FNR	24-36 x 66 x 29.5	70	142	7	\$963	\$399

Extended worksurface on left. **Narrow end panel on right. Full end panel on left.** Connects to 30"D space saver connectables, 24"D returns or 24"D connectable tables. **Full end panel cannot be connected.** Corner has one grommet. Predrilled to accept 22" keyboard trays. **Will not accept keyboard trays wider than 22"**. Shipped RTA (ready to assemble).

- **Modesty Panel is 1" off of ground.**
- **A2466FNR cannot accept pedestals.**

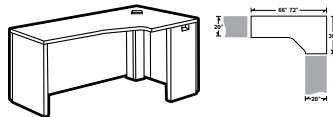

Right Extended Corner

A2072FNR	20-36 x 72 x 29.5	70	141	7	\$917	\$383
A2066FNR	20-36 x 66 x 29.5	70	135	7	\$917	\$383

Extended worksurface on left. **Narrow end panel on right. Full end panel on left.** Connects to 24"D space saver connectables, 20"D returns or 20"D connectable tables. **Full end panel cannot be connected.** Corner has one grommet. Predrilled to accept 22" keyboard trays. **Will not accept keyboard trays wider than 22"**. Shipped RTA (ready to assemble).

- **Modesty Panel is 1" off of ground.**

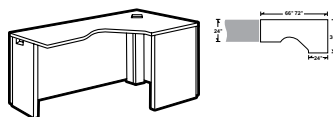

Right Extended Corner

A2472NFR	24-36 x 72 x 29.5	70	149	7	\$963	\$399
A2466NFR	24-36 x 66 x 29.5	70	142	7	\$963	\$399

Extended worksurface on left. **Narrow end panel on left. Full end panel on right.** Connects to 30"D space saver connectables, 24"D returns or 24"D connectable tables. **Full end panel cannot be connected.** Corner has one grommet. Predrilled to accept 22" keyboard trays. **Will not accept keyboard trays wider than 22"**. Shipped RTA (ready to assemble).

- **Modesty Panel is 1" off of ground.**
- **A2466NFR cannot accept pedestals.**

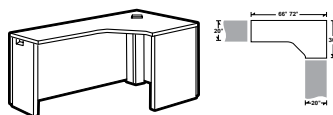

Right Extended Corner

A2072NFR	20-36 x 72 x 29.5	70	141	7	\$917	\$399
A2066NFR	20-36 x 66 x 29.5	70	135	7	\$917	\$383

Extended worksurface on left. **Narrow end panel on left. Full end panel on right.** Connects to 24"D space saver connectables and 20"D returns. **Full end panel cannot be connected.** Corner has one grommet. Predrilled to accept 22" keyboard trays. **Will not accept keyboard trays wider than 22"**. Shipped RTA (ready to assemble).

- **Modesty Panel is 1" off of ground.**

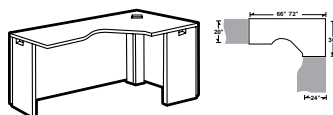

Right Extended Corner

A2472NNR	24-36 x 72 x 29.5	70	140	7	\$931	\$399
A2466NNR	24-36 x 66 x 29.5	70	133	7	\$931	\$399

Extended worksurface on left. **Narrow end panels on left and right.** Connects to 30"D space saver connectables, 24"D returns and 24"D connectable tables on either end. Corner has one grommet. Predrilled to accept 22" keyboard trays. **Will not accept keyboard trays wider than 22"**. Shipped RTA (ready to assemble).

- **Modesty Panel is 1" off of ground.**
- **A2466NNR cannot accept pedestals.**

Required Specifications

Top finish
Base finish

Optional Specifications

Additional grommet position
HP laminate
Power block cut-out

Accessories

Power block
Keyboard tray
Pencil tray

RIGHT EXTENDED CORNERS

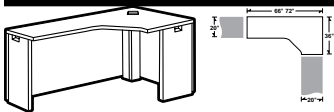

Right Extended Corner

MODEL#	DIMENSIONS	FREIGHT CLASS	WT./LBS.	CUBIC FT.	LIST PRICE	HP ADD
	D x W x H					
A2072NNR	20-36 x 72 x 29.5	70	136	7	\$905	\$399
A2066NNR	20-36 x 66 x 29.5	70	130	7	\$905	\$383

Extended worksurface on left. **Narrow end panels on left and right.** Connects to 24"D space saver connectables and 20"D returns or bridge on either end. Corner has one grommet. Predrilled to accept 22" keyboard trays. **Will not accept keyboard trays wider than 22"**. Shipped RTA (ready to assemble).

- Modesty Panel is 1" off of ground.

FREESTANDING TABLES

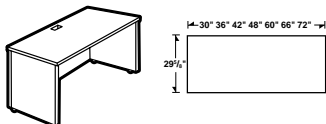

30" Deep Freestanding Table

MODEL#	DIMENSIONS	FREIGHT CLASS	WT./LBS.	CUBIC FT.	LIST PRICE	HP ADD
A3072T	29.69 x 72 x 29.5	65	148	6	\$763	\$373
A3066T	29.69 x 66 x 29.5	65	140	6	\$763	\$373
A3060T	29.69 x 60 x 29.5	65	131	5.25	\$697	\$347
A3048T	29.69 x 48 x 29.5	70	116	5.25	\$631	\$294
A3042T	29.69 x 42 x 29.5	70	108	5.25	\$631	\$266
A3036T	29.69 x 36 x 29.5	65	97	4.30	\$566	\$240
A3030T	29.69 x 30 x 29.5	65	88	3.60	\$533	\$214

Two full end panels. Cannot be connected on left or right side. Grommet in worksurface. Shipped RTA (ready to assemble).

- Modesty Panel is 1" off of ground

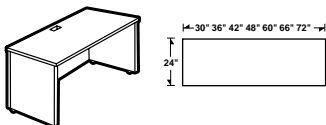

24" Deep Freestanding Table

A2472T	24 x 72 x 29.5	70	130	6	\$697	\$278
A2466T	24 x 66 x 29.5	70	123	6	\$697	\$278
A2460T	24 x 60 x 29.5	70	114	5.25	\$631	\$256
A2448T	24 x 48 x 29.5	65	99	4.30	\$566	\$203
A2442T	24 x 42 x 29.5	70	92	4.30	\$566	\$170
A2436T	24 x 36 x 29.5	70	84	4.20	\$501	\$128
A2430T	24 x 30 x 29.5	70	76	3.60	\$467	\$128

Two full end panels. Cannot be connected on left or right side. Grommet in worksurface. Shipped RTA (ready to assemble).

- Modesty Panel is 1" off of ground

CONNECTABLE TABLES - LEFT

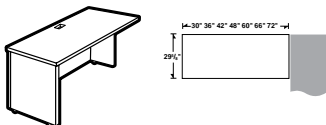

30" Deep Connectable Table - LEFT

MODEL#	DIMENSIONS	FREIGHT CLASS	WT./LBS.	CUBIC FT.	LIST PRICE	HP ADD
A3072L	29.69 x 72 x 29.5	65	140	6	\$736	\$373
A3066L	29.69 x 66 x 29.5	70	132	6	\$736	\$373
A3060L	29.69 x 60 x 29.5	65	123	5.25	\$673	\$347
A3048L	29.69 x 48 x 29.5	65	105	4.30	\$606	\$294
A3042L	29.69 x 42 x 29.5	65	98	4.30	\$606	\$266
A3036L	29.69 x 36 x 29.5	70	88	4.20	\$540	\$240
A3030L	29.69 x 30 x 29.5	70	80	3.60	\$508	\$214

Full end panel on left. Right narrow end panel connects to 30"D center/right connectable table, or at 90° angle to a freestanding table; and "D" islands or "P" islands with "T" and "H" bases. Grommet in worksurface. Shipped RTA (ready to assemble).

- Modesty Panel is 1" off of ground.

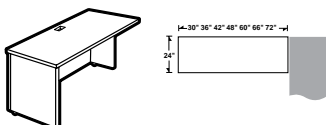

24" Deep Connectable Table - LEFT

A2472L	24 x 72 x 29.5	70	121	6	\$673	\$278
A2466L	24 x 66 x 29.5	70	115	6	\$673	\$278
A2460L	24 x 60 x 29.5	70	106	5.25	\$606	\$256
A2448L	24 x 48 x 29.5	70	90	4.30	\$540	\$203
A2442L	24 x 42 x 29.5	70	82	3.80	\$540	\$170
A2436L	24 x 36 x 29.5	70	74	3.30	\$475	\$128
A2430L	24 x 30 x 29.5	70	68	3.60	\$442	\$128

Full end panel on left. Right narrow end panel connects to 24"D center/right connectable table, or at 90° angle to a freestanding table; 24"D extended corners, 42" 5-sided corners or at the end of a straight run; "D" islands or "P" islands with "T" and "H" bases. Grommet in worksurface. Shipped RTA (ready to assemble).

- Modesty Panel is 1" off of ground.

Required Specifications

Top finish
Base finish

Optional Specifications

Additional grommet position
HP laminate
Power block cut-out

Accessories

Power block
Keyboard tray
Pencil tray

CONNECTABLE TABLES - RIGHT

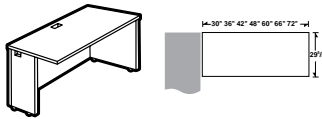

30" Deep Connectable Table - RIGHT

MODEL#	DIMENSIONS	FREIGHT CLASS	WT./LBS.	CUBIC FT.	LIST PRICE	HP ADD
D x W x H						
A3072R	29.69 x 72 x 29.5	65	140	6	\$736	\$373
A3066R	29.69 x 66 x 29.5	70	132	6	\$736	\$373
A3060R	29.69 x 60 x 29.5	65	123	5.25	\$673	\$347
A3048R	29.69 x 48 x 29.5	65	105	4.30	\$606	\$294
A3042R	29.69 x 42 x 29.5	65	98	4.30	\$606	\$266
A3036R	29.69 x 36 x 29.5	70	88	4.30	\$540	\$240
A3030R	29.69 x 30 x 29.5	70	80	3.60	\$508	\$214

Full end panel on **right**. Left narrow end panel connects to 30"D center/left connectable table, or at 90° angle to a freestanding table; "D" islands or "P" islands with "T" and "H" bases. Grommet in worksurface. Shipped RTA (ready to assemble).

- Modesty Panel is 1" off of ground

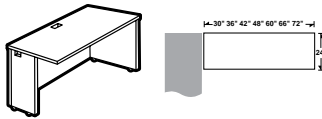

24" Deep Connectable Table - RIGHT

A2472R	24 x 72 x 29.5	70	121	6	\$673	\$278
A2466R	24 x 66 x 29.5	70	115	6	\$673	\$278
A2460R	24 x 60 x 29.5	70	105	5.25	\$606	\$256
A2448R	24 x 48 x 29.5	70	90	4.30	\$540	\$203
A2442R	24 x 42 x 29.5	70	82	3.80	\$540	\$170
A2436R	24 x 36 x 29.5	70	74	3.30	\$475	\$128
A2430R	24 x 30 x 29.5	70	67	3.60	\$442	\$128

Full end panel on **right**. Left narrow end panel connects to 24"D center/left connectable table, or at 90° angle to a freestanding table; 24"D extended corners, 42" 5-sided corners or at the end of a straight run; "D" islands or "P" islands with "T" and "H" bases. Grommet in worksurface. Shipped RTA (ready to assemble).

- Modesty Panel is 1" off of ground

CONNECTABLE TABLES

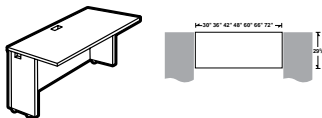

30" Deep Connectable Table

MODEL#	DIMENSIONS	FREIGHT CLASS	WT./LBS.	CUBIC FT.	LIST PRICE	HP ADD
A3072N	29.69 x 72 x 29.5	70	131	6	\$713	\$373
A3066N	29.69 x 66 x 29.5	70	124	6	\$713	\$373
A3060N	29.69 x 60 x 29.5	70	114	5.25	\$645	\$347
A3048N	29.69 x 48 x 29.5	65	97	4.30	\$580	\$294
A3042N	29.69 x 42 x 29.5	65	89	3.80	\$580	\$266
A3036N	29.69 x 36 x 29.5	65	80	3.30	\$515	\$240
A3030N	29.69 x 30 x 29.5	70	71	3.60	\$482	\$214

Narrow end panels on both sides connects to 30"D worksurfaces; "D" islands or "P" islands with "T" and "H" bases; or at 90° angle to freestanding table(s). Grommet in worksurface. Shipped RTA (ready to assemble).

- Modesty Panel is 1" off of ground

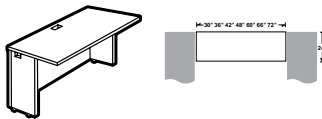

24" Deep Connectable Table

A2472N	24 x 72 x 29.5	70	113	6	\$645	\$278
A2466N	24 x 66 x 29.5	70	105	6	\$645	\$278
A2460N	24 x 60 x 29.5	70	100	4.50	\$580	\$256
A2448N	24 x 48 x 29.5	70	82	4.30	\$515	\$203
A2442N	24 x 42 x 29.5	70	73	3.80	\$515	\$170
A2436N	24 x 36 x 29.5	70	66	3.30	\$451	\$128
A2430N	24 x 30 x 29.5	70	59	3.60	\$416	\$128

Narrow end panels on both sides connects to 24"D worksurfaces; "D" islands or "P" islands with "T" and "H" bases; or at 90° angle to freestanding table(s). Grommet in worksurface. Shipped RTA (ready to assemble).

- Modesty Panel is 1" off of ground

SPACE SAVER CONNECTABLE TABLES - LEFT

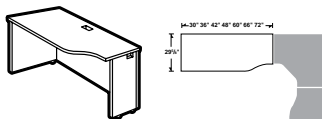

30" Deep Space Saver Connectable Table - LEFT

MODEL#	DIMENSIONS	FREIGHT CLASS	WT./LBS.	CUBIC FT.	LIST PRICE	HP ADD
A3072LK	29.69 x 72 x 29.5	70	133	6	\$745	\$373
A3066LK	29.69 x 66 x 29.5	70	126	6	\$745	\$373
A3060LK	29.69 x 60 x 29.5	70	117	5.25	\$680	\$347
A3048LK	29.69 x 48 x 29.5	65	100	4.30	\$614	\$294
A3042LK	29.69 x 42 x 29.5	65	92	3.80	\$614	\$266
A3036LK	29.69 x 36 x 29.5	70	83	4.30	\$547	\$240
A3030LK	29.69 x 30 x 29.5	70	74	3.60	\$515	\$214

Full end panel on left. Narrow right end panel connects to 24"D 5-sided corner unit. Grommet in worksurface. Shipped RTA (ready to assemble).

- Modesty Panel is 1" off of ground
- Keyboard and pencil trays for use on units 42" and above

Required Specifications

Top finish
Base finish

Optional Specifications

Additional grommet position
HP laminate
Power block cut-out

Accessories

Power block
Keyboard tray
Pencil tray

SPACE SAVER CONNECTABLE TABLES - LEFT

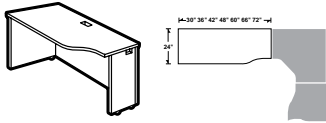

24" Deep Space Saver Connectable Table - LEFT

MODEL#	DIMENSIONS	FREIGHT CLASS	WT./LBS.	CUBIC FT.	LIST PRICE	HP ADD
	D x W x H					
A2472LK	24 x 72 x 29.5	70	120	6	\$680	\$278
A2466LK	24 x 66 x 29.5	70	114	6	\$680	\$278
A2460LK	24 x 60 x 29.5	70	105	5.25	\$614	\$256
A2448LK	24 x 48 x 29.5	70	89	4.30	\$547	\$203
A2442LK	24 x 42 x 29.5	70	81	3.80	\$547	\$170
A2436LK	24 x 36 x 29.5	70	73	3.30	\$482	\$128
A2430LK	24 x 30 x 29.5	70	66	3.60	\$451	\$128

Full end panel on left. Narrow right end panel connects to 20"D 5-sided corner unit. Grommet in worksurface. Shipped RTA (ready to assemble).

- **Modesty Panel is 1" off of ground.**
- Keyboard and pencil trays for use on units 42" and above

SPACE SAVER CONNECTABLE TABLES - RIGHT

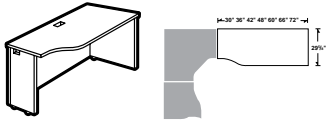

30" Deep Space Saver Connectable Table - RIGHT

MODEL#	DIMENSIONS	FREIGHT CLASS	WT./LBS.	CUBIC FT.	LIST PRICE	HP ADD
A3072RK	29.69 x 72 x 29.5	70	133	6	\$745	\$373
A3066RK	29.69 x 66 x 29.5	70	126	6	\$745	\$373
A3060RK	29.69 x 60 x 29.5	70	117	5.25	\$680	\$347
A3048RK	29.69 x 48 x 29.5	65	100	4.30	\$614	\$294
A3042RK	29.69 x 42 x 29.5	65	91	3.80	\$614	\$266
A3036RK	29.69 x 36 x 29.5	70	83	4.30	\$547	\$240
A3030RK	29.69 x 30 x 29.5	70	74	3.60	\$515	\$214

Full end panel on right. Narrow right end panel connects to 24"D 5-sided corner unit. Grommet in worksurface. Shipped RTA (ready to assemble).

- **Modesty Panel is 1" off of ground**
- Keyboard and pencil trays for use on units 42" and above

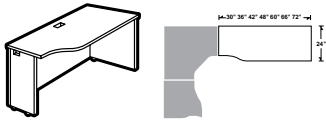

24" Deep Space Saver Connectable Table - RIGHT

A2472RK	24 x 72 x 29.5	70	120	6	\$680	\$278
A2466RK	24 x 66 x 29.5	70	114	6	\$680	\$278
A2460RK	24 x 60 x 29.5	70	105	5.25	\$614	\$256
A2448RK	30 x 48 x 29.5	70	89	4.30	\$547	\$203
A2442RK	24 x 42 x 29.5	70	81	3.80	\$547	\$170
A2436RK	24 x 36 x 29.5	70	73	3.30	\$482	\$128
A2430RK	24 x 30 x 29.5	70	66	3.60	\$451	\$128

Full end panel on right. Narrow right end panel connects to 20"D 5-sided corner unit. Grommet in worksurface. Shipped RTA (ready to assemble).

- **Modesty Panel is 1" off of ground.**
- Keyboard and pencil trays for use on units 42" and above

SPACE SAVER CONNECTABLE TABLES

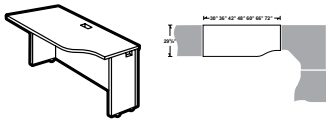

30" Deep Space Saver Connectable Table

MODEL#	DIMENSIONS	FREIGHT CLASS	WT./LBS.	CUBIC FT.	LIST PRICE	HP ADD
A3072LN	29.69 x 72 x 29.5	70	125	6	\$721	\$373
A3066LN	29.69 x 66 x 29.5	70	117	6	\$721	\$373
A3060LN	29.69 x 60 x 29.5	70	108	5.25	\$657	\$347
A3048LN	29.69 x 48 x 29.5	70	91	4.30	\$591	\$294
A3042LN	29.69 x 42 x 29.5	70	83	3.80	\$591	\$266
A3036LN	29.69 x 36 x 29.5	70	74	3.30	\$526	\$240
A3030LN	29.69 x 30 x 29.5	70	66	3.60	\$491	\$214

Narrow end panels on both sides. Connects the **right end only to 24"D 5-sided corner unit.** Left end allows the continuation of additional connectable center or left connectable worksurface. Grommet in worksurface. Shipped RTA (ready to assemble).

- **Modesty Panel is 1" off of ground.**
- Keyboard and pencil trays for use on units 42" and above

Required Specifications

Top finish
Base finish

Optional Specifications

Additional grommet position
HP laminate
Power block cut-out

Accessories

Power block
Keyboard tray
Pencil tray

SPACE SAVER CONNECTABLE TABLES

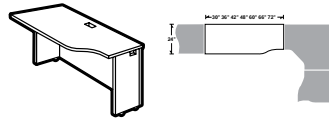

24" Deep Space Saver Connectable Table

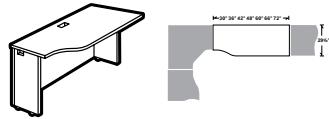

30" Deep Space Saver Connectable Table

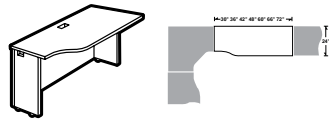

24" Deep Space Saver Connectable Table

MODEL# DIMENSIONS FREIGHT CLASS WT./LBS. CUBIC FT. LIST PRICE HP ADD

D x W x H

A2472LN	24 x 72 x 29.5	70	112	6	\$657	\$278
A2466LN	24 x 66 x 29.5	70	105	6	\$657	\$278
A2460LN	24 x 60 x 29.5	70	96	5.25	\$591	\$256
A2448LN	24 x 48 x 29.5	70	81	4.30	\$526	\$203
A2442LN	24 x 42 x 29.5	70	73	3.80	\$526	\$170
A2436LN	24 x 36 x 29.5	70	65	3.30	\$460	\$128
A2430LN	24 x 30 x 29.5	70	58	3.60	\$427	\$128

Narrow end panels on both sides. Connects the **right end only to 20" D 5-sided corner unit.** Left end allows the continuation of additional connectable center or left connectable worksurface. Grommet in worksurface. Shipped RTA (ready to assemble).

- **Modesty Panel is 1" off of ground.**
- *Keyboard and pencil trays for use on units 42" and above*

A3072RN	29.69 x 72 x 29.5	70	125	6	\$721	\$373
A3066RN	29.69 x 66 x 29.5	70	117	6	\$721	\$373
A3060RN	29.69 x 60 x 29.5	70	108	5.25	\$657	\$347
A3048RN	29.69 x 48 x 29.5	70	91	4.30	\$591	\$294
A3042RN	29.69 x 42 x 29.5	70	83	3.80	\$591	\$266
A3036RN	29.69 x 36 x 29.5	70	74	3.30	\$526	\$240
A3030RN	29.69 x 30 x 29.5	70	66	3.60	\$491	\$214

Narrow end panels on both sides. Connects the **left end only to 24" D 5-sided corner unit.** Right end allows the continuation of additional connectable center or right connectable worksurface. Grommet in worksurface. Shipped RTA (ready to assemble).

- **Modesty Panel is 1" off of ground.**
- *Keyboard and pencil trays for use on units 42" and above*

A2472RN	24 x 72 x 29.5	70	112	6	\$657	\$278
A2466RN	24 x 66 x 29.5	70	105	6	\$657	\$278
A2460RN	24 x 60 x 29.5	70	96	5.25	\$591	\$256
A2448RN	24 x 48 x 29.5	70	81	4.30	\$526	\$203
A2442RN	24 x 42 x 29.5	70	72	3.80	\$526	\$170
A2436RN	24 x 36 x 29.5	70	59	3.30	\$460	\$128
A2430RN	24 x 30 x 29.5	85	53	3.60	\$427	\$128

Narrow end panels on both sides. Connects the **left end only to 20" D 5-sided corner unit.** Right end allows the continuation of additional connectable center or right connectable worksurface. Grommet in worksurface. Shipped RTA (ready to assemble).

- **Modesty Panel is 1" off of ground.**
- *Keyboard and pencil trays for use on units 42" and above*

"D" ISLANDS

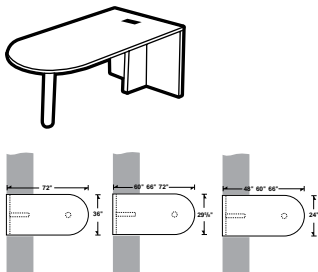

"D" Island - Full End Panel & Post (T-Base)

MODEL# DIMENSIONS FREIGHT CLASS WT./LBS. CUBIC FT. LIST PRICE HP ADD

A3672FI	36 x 72 x 29.5	85	124	8.50	\$811	\$399
A3072FI	29.69 x 72 x 29.5	85	107	7.50	\$787	\$374
A3066FI	29.69 x 66 x 29.5	85	102	7.50	\$745	\$373
A3060FI	29.69 x 60 x 29.5	85	96	6.76	\$705	\$347
A2466FI	24 x 66 x 29.5	85	90	7.50	\$663	\$278
A2460FI	24 x 60 x 29.5	85	84	6.76	\$624	\$256
A2448FI	24 x 48 x 29.5	85	74	5.76	\$580	\$203

Connects to narrow end panel. Attaching hardware included. Not freestanding. Grommet in worksurface. Shipped RTA (ready to assemble).

- Post is shipped in a separate carton. Standard in Black; Silver is available at no charge, please specify **SI**.

Required Specifications

Top finish
Base finish

Optional Specifications

Additional grommet position
HP laminate
Power block cut-out

Accessories

Power block
Keyboard tray
Pencil tray

A ADAPTABILITIES®

"D" ISLANDS

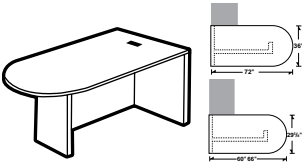

"D" Island LEFT - Full Modesty Panel (H-Base)

MODEL#	DIMENSIONS D x W x H	FREIGHT CLASS	WT/LBS.	CUBIC FT.	LIST PRICE	HP ADD
A3672FIL	36 x 72 x 29.5	70	139	7	\$745	\$399
A3066FIL	29.69 x 66 x 29.5	70	116	6	\$663	\$373
A3060FIL	29.69 x 60 x 29.5	70	106	5.25	\$624	\$347

Connects to the left side of a worksurface. Accommodates all 19" pedestals (freestanding, mobile and hanging pedestals). Grommet in worksurface. Shipped RTA (ready to assemble).

- Modesty Panel is 1" off of ground.

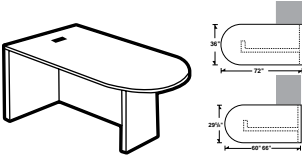

"D" Island RIGHT - Full Modesty Panel (H-Base)

A3672FIR	36 x 72 x 29.5	70	139	7	\$745	\$399
A3066FIR	29.69 x 66 x 29.5	70	116	6	\$663	\$373
A3060FIR	29.69 x 60 x 29.5	70	106	5.25	\$624	\$347

Connects to the right side of a worksurface. Accommodates all 19" pedestals (freestanding, mobile and hanging pedestals). Grommet in worksurface. Shipped RTA (ready to assemble).

- Modesty Panel is 1" off of ground.

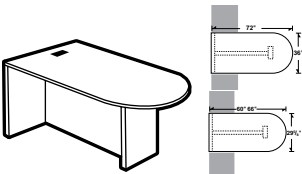

"D" Island Center - Full Modesty Panel (H-Base)

A3672FIC	36 x 72 x 29.5	70	139	7	\$745	\$399
A3066FIC	29.69 x 66 x 29.5	70	116	6	\$663	\$373
A3060FIC	29.69 x 60 x 29.5	70	106	5.25	\$624	\$347

Connects in between two worksurfaces. Will not accommodate pedestals. Grommet in worksurface. Shipped RTA (ready to assemble).

- Modesty Panel is 1" off of ground.

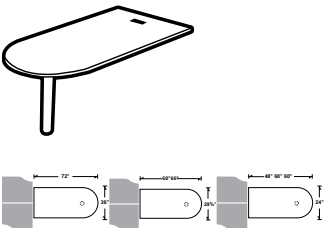

Attachable "D" Island with Post*

A3672I	36 x 72 x 29.5	92.5	88	8.50	\$705	\$399
A3066I	29.69 x 66 x 29.5	100	71	7.50	\$624	\$373
A3060I	29.69 x 60 x 29.5	100	65	6.76	\$580	\$347
A2466I	24 x 66 x 29.5	100	63	7.50	\$540	\$278
A2460I	24 x 60 x 29.5	100	57	6.76	\$501	\$256
A2448I	24 x 48 x 29.5	100	47	5.76	\$460	\$203

Attaches to edge of worksurfaces. Attaching hardware included. Grommet in worksurface. Shipped RTA (ready to assemble).

- Post is shipped in a separate carton. Standard in Black; Silver is available at no charge, please specify **SIL**.

EXTENDED CORNER ISLANDS

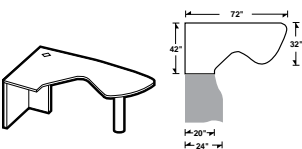

Extended Corner Island - RIGHT*

MODEL#	DIMENSIONS	FREIGHT CLASS	WT/LBS.	CUBIC FT.	LIST PRICE	HP ADD
A4272EIR	42-32 x 72 x 29.5	100	104	11.50	\$973	\$532

Extended island worksurface on right. Connects to 20"D returns or 24"D space saver connectables on the left. **Not freestanding.** Predrilled to accept 22"-28" keyboard trays. Grommet in worksurface. Shipped RTA (ready to assemble).

- Post is shipped in separate carton. Standard in Black; Silver is available at no charge, please specify **SI**.

Required Specifications

Top finish
Base finish
Post finish*

Optional Specifications

Additional grommet position
HP laminate
Power block cut-out

Accessories

Power block
Keyboard tray
Pencil tray

EXTENDED CORNER ISLANDS

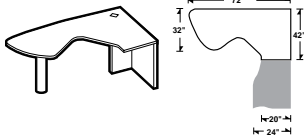

Extended Corner Island - LEFT*

MODEL#	DIMENSIONS	FREIGHT CLASS	WT/LBS.	CUBIC FT.	LIST PRICE	HP ADD
D x W x H						
A4272EIL	42-32 x 72 x 29.5	100	104	11.50	\$973	\$532

Extended island worksurface on left. Connects to 20"D returns or 24"D space saver connectables on the right. **Not freestanding.** Predrilled to accept 22"-28" keyboard trays. Grommet in worksurface. Shipped RTA (ready to assemble).

- Post is shipped in separate carton. Standard in Black; Silver is available at no charge, please specify **SI**.

"P" ISLANDS

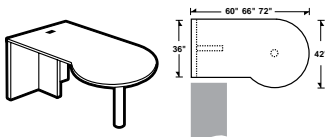

"P" Island LEFT - Full End Panel & Post (T-Base)*

MODEL#	DIMENSIONS	FREIGHT CLASS	WT/LBS.	CUBIC FT.	LIST PRICE	HP ADD
A3672FPL	36-42 x 72 x 29.5	85	128	9.26	\$952	\$532
A3666FPL	36-42 x 66 x 29.5	85	122	8.76	\$870	\$532
A3660FPL	36-42 x 60 x 29.5	85	116	8	\$828	\$453

Connects to left side of worksurface. Attaching hardware included. **Not freestanding.** Grommet in worksurface. Shipped RTA (ready to assemble).

- Post is shipped in separate carton. Standard in Black; Silver is available at no charge, please specify **SI**.

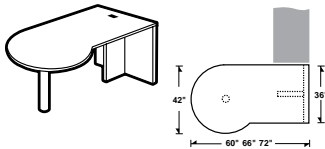

"P" Island RIGHT - Full End Panel & Post (T-Base)*

A3672FPR	36-42 x 72 x 29.5	85	128	9.26	\$952	\$532
A3666FPR	36-42 x 66 x 29.5	85	122	8.76	\$870	\$532
A3660FPR	36-42 x 60 x 29.5	85	116	8	\$828	\$453

Connects to right side of worksurface. Attaching hardware included. **Not freestanding.** Grommet in worksurface. Shipped RTA (ready to assemble).

- Post is shipped in separate carton. Standard in Black; Silver is available at no charge, please specify **SI**.

"P" ISLANDS WITH FULL MODESTY PANEL

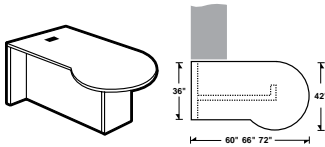

"P" Island LEFT - Full Modesty Panel (H-Base)

MODEL#	DIMENSIONS	FREIGHT CLASS	WT/LBS.	CUBIC FT.	LIST PRICE	HP ADD
A3672PL	36-42 x 72 x 29.5	70	143	7.75	\$870	\$532
A3666PL	36-42 x 66 x 29.5	70	136	7.25	\$787	\$532
A3660PL	36-42 x 60 x 29.5	70	126	6.50	\$745	\$453

Connects to the left side of a worksurface. Accommodates all 19" pedestals (freestanding, mobile and hanging pedestals). Grommet in worksurface. Shipped RTA (ready to assemble).

- Modesty Panel is 1" off of ground.

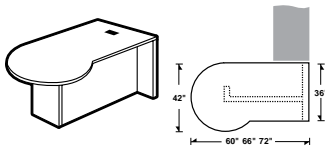

"P" Island RIGHT - Full Modesty Panel (H-Base)

A3672PR	36-42 x 72 x 29.5	70	143	7.75	\$870	\$532
A3666PR	36-42 x 66 x 29.5	70	136	7.25	\$787	\$532
A3660PR	36-42 x 60 x 29.5	70	126	6.50	\$745	\$453

Connects to the right side of a worksurface. Accommodates all 19" pedestals (freestanding, mobile and hanging pedestals). Grommet in worksurface. Shipped RTA (ready to assemble).

- Modesty Panel is 1" off of ground.

Required Specifications

Top finish
Base finish
Post finish*

Optional Specifications

Additional grommet position
HP laminate
Power block cut-out

Accessories

Power block
Keyboard tray
Pencil tray

A ADAPTABILITIES®

"P" ISLANDS (ATTACHABLE)

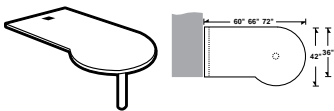

"P" Island LEFT with Post*

MODEL#	DIMENSIONS	FREIGHT CLASS	WT/LBS.	CUBIC FT.	LIST PRICE	HP ADD
A3672IPL	36-42 x 72 x 29.5	100	92	9.26	\$828	\$532
A3666IPL	36-42 x 66 x 29.5	100	86	8.76	\$745	\$532
A3660IPL	36-42 x 60 x 29.5	92.5	80	8	\$705	\$453

Attaches to edge of worksurfaces. Attaching hardware included. Grommet in worksurface. Shipped RTA (ready to assemble).
 • Post is shipped in separate carton. Standard in Black; Silver is available at no charge, please specify **SI**.

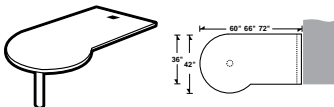

"P" Island RIGHT with Post*

A3672IPR	36-42 x 72 x 29.5	100	92	9.26	\$828	\$532
A3666IPR	36-42 x 66 x 29.5	100	86	8.76	\$745	\$532
A3660IPR	36-42 x 60 x 29.5	92.5	80	8	\$705	\$453

Attaches to edge of worksurfaces. Attaching hardware included. Grommet in worksurface. Shipped RTA (ready to assemble).
 • Post is shipped in separate carton. Standard in Black; Silver is available at no charge, please specify **SI**.

RADIUS SPANNER ISLANDS

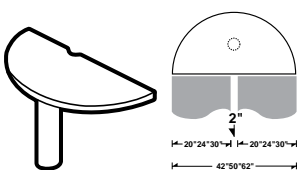

Radius Spanner Island with Panel Cut-Out*

MODEL#	DIMENSIONS	FREIGHT CLASS	WT/LBS.	CUBIC FT.	LIST PRICE	HP ADD
A62RS	31 x 62 x 29.5	100	59	6.76	\$763	\$320
A50RS	25 x 50 x 29.5	125	46	5.76	\$663	\$266
A42RS	21 x 42 x 29.5	125	41	5.26	\$600	\$214

Used to connect two back-to-back units of same depth with a panel. Includes monopost. Requires "L" bracket (model **MLB90**) for connection to full end panels. Shipped RTA (ready to assemble).

- MLB90 must be ordered separately - see page 549.
- Post is shipped in separate carton. Standard in Black; Silver is available at no charge, please specify **SI**.
- **Cannot accept keyboard trays or pencil tray**

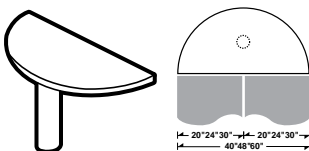

Radius Spanner Island*

A60RS	29.69 x 60 x 29.5	100	56	5.76	\$763	\$266
A48RS	24 x 48 x 29.5	125	43	5.76	\$663	\$214
A40RS	20 x 40 x 29.5	125	40	5.26	\$600	\$214

Used to connect two back-to-back units of same depth. Includes monopost. Requires "L" bracket (model **MLB90**) for connection to full end panels. Shipped RTA (ready to assemble).

- MLB90 must be ordered separately - see page 549.
- Post is shipped in separate carton. Standard in Black; Silver is available at no charge, please specify **SI**.
- **Cannot accept keyboard trays or pencil tray**

RECEPTION DESKS

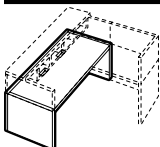

Lower Desk Unit**

MODEL#	DIMENSIONS	FREIGHT CLASS	WT/LBS.	CUBIC FT.	LIST PRICE	HP ADD
A3072RD	29.69 x 72 x 29.5	70	149	7	\$828	\$373

No pedestals. Two grommets in worksurface. Shipped RTA (ready to assemble).
 • Cannot be used with Divide.

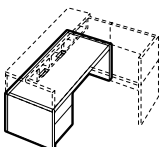

Single Pedestal Lower Desk Unit - LEFT**

A3072RDL	29.69 x 72 x 29.5	150	222	43.75	\$1198	\$373
A3060RDL	29.63 x 60 x 29	150	201	36	\$1034	\$347

Box/file pedestal on **left** with lock. Two grommets in worksurface.
 • Cannot be used with Divide.

Required Specifications

Top finish
 Base finish (not radius spanner islands)
 Post finish*

Optional Specifications

Additional grommet position*
 HP laminate*
 Power block cut-out*

Accessories

Power block*
 Keyboard tray**
 Pencil tray**

RECEPTION DESKS

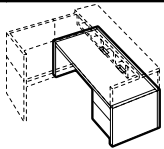

Single Pedestal Lower Desk Unit - RIGHT

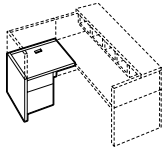

Reception Return - LEFT

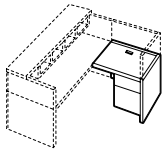

Reception Return - RIGHT



Reception Return - LEFT



Reception Return - RIGHT

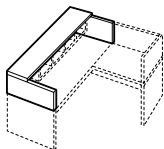

Transaction Counter

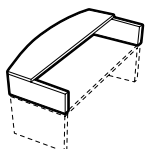

Bow Front Transaction Counter

MODEL#	DIMENSIONS D x W x H	FREIGHT CLASS	WT/LBS.	CUBIC FT.	LIST PRICE	HP ADD
A3072RDR	29.69 x 72 x 29.5	150	222	43.75	\$1198	\$373
A3060RDR	29.63 x 60 x 29	150	201	36	\$1034	\$347

Box/file pedestal on **right** with lock. Two grommets in worksurface.
 • Cannot be used with Divide.

A2442RRL	24 x 42 x 29.5	125	131	21.25	\$787	\$170
----------	----------------	-----	-----	-------	--------------	--------------

Box/file pedestal on **left** with lock. Grommet in worksurface.
 • Cannot be used with Divide.
 • **Cannot accept keyboard trays or pencil tray**

A2442RRR	24 x 42 x 29.5	125	131	21.25	\$787	\$170
----------	----------------	-----	-----	-------	--------------	--------------

Box/file pedestal on **right** with lock. Grommet in worksurface.
 • Cannot be used with Divide.
 • **Cannot accept keyboard trays or pencil tray**

A2442KRL	24 x 42 x 29.5	70	83	3.80	\$580	\$170
----------	----------------	----	----	------	--------------	--------------

No pedestal. Grommet in worksurface.
 • Cannot be used with Divide.

A2442KRR	24 x 42 x 29.5	70	83	3.80	\$580	\$170
----------	----------------	----	----	------	--------------	--------------

No pedestal. Grommet in worksurface.
 • Cannot be used with Divide.

A3072URD	29.69 x 72 x 13.75	70	67	4.30	\$501	\$214
A3060URD	29.63 x 60 x 13.75	65	59	2.60	\$470	\$214

For main reception desk. Shipped RTA (ready to assemble). Depth of reception top is 12".
 • Reception top units are to be used only with lower reception units. Tops have mini-fix fasteners to attach the reception top units.

A3072URB	29.69-36 x 72 x 13.75	70	72	4.30	\$679	\$266
----------	-----------------------	----	----	------	--------------	--------------

For main reception desk. To be used on A3072RD, A3072RDL or A3072RDR. Shipped RTA (ready to assemble). Depth of reception bow top is 12-15".
 • Reception top units are to be used only with desks listed. Tops have mini-fix fasteners to attach the reception top units.

Required Specifications

Top finish
 Base finish

Optional Specifications

Additional grommet position*
 HP laminate*
 Power block cut-out*

Accessories

Power block*
 Keyboard tray*
 Pencil tray*

RECEPTION DESKS

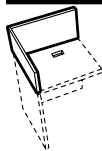

Return Screen Unit - LEFT

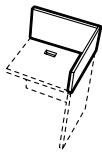

Return Screen Unit - RIGHT

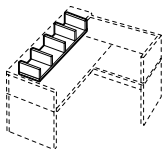

Desk Top Organizer

MODEL#	DIMENSIONS	FREIGHT CLASS	WT/LBS.	CUBIC FT.	LIST PRICE	HP ADD
--------	------------	---------------	---------	-----------	------------	--------

D x W x H

A2442URL	24 x 42 x 12.75	85	27	2	\$253	N/A
----------	-----------------	----	----	---	--------------	-----

To be used on top of left reception return (A2442RRL/KRL). Shipped RTA (ready to assemble).

- Reception top units are to be used only with returns listed. Tops have mini-fix fasteners to attach the reception top units.

A2442URR	24 x 42 x 12.75	85	27	2	\$253	N/A
----------	-----------------	----	----	---	--------------	-----

To be used on top of right reception return (A2442RRR/KRR). Shipped RTA (ready to assemble).

- Reception top units are to be used only with returns listed. Tops have mini-fix fasteners to attach the reception top units.

A1172ORD	11 x 52 x 6	100	22	2.60	\$169	N/A
----------	-------------	-----	----	------	--------------	-----

To be used under transaction counter. Black (BK) finish only. Shipped RTA (ready to assemble).

WALL/PANEL MOUNT OVERSTORAGE UNITS

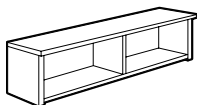

Overstorage Unit*

MODEL#	DIMENSIONS	FREIGHT CLASS	WT/LBS.	CUBIC FT.	LIST PRICE	HP ADD
--------	------------	---------------	---------	-----------	------------	--------

A00S60	15 x 60 x 16	70	86	5.25	\$622	N/A
A00S48	15 x 48 x 16	70	70	4.30	\$508	N/A
A00S42	15 x 42 x 16	70	62	3.80	\$501	N/A
A00S36	15 x 36 x 16	70	56	3.30	\$442	N/A
A00S30	15 x 30 x 16	70	48	3	\$414	N/A

Standard with pre-mounted "J" bracket for wall mount applications. One fixed shelf, closed back. Uses standard Adaptabilities hutch doors. Shipped RTA (ready to assemble).

- **NOTE:** Care should be taken to mount the units. Units should be mounted to wall studs using correct fasteners. Failure to do so may result in collapse of the unit and subsequent personal injury. **Mounting hardware not included.** Mounting hardware used should be based on wall material. Consult an installation professional for proper wall mounting.

OPEN HUTCHES

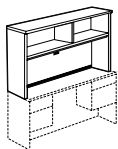

Open Hutch with Closed Back*

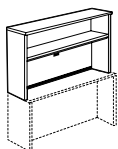
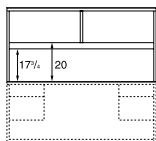

Open Hutch with Closed Back

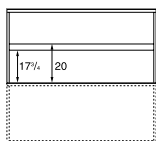

MODEL#	DIMENSIONS	FREIGHT CLASS	WT/LBS.	CUBIC FT.	LIST PRICE	HP ADD
--------	------------	---------------	---------	-----------	------------	--------

A72HOCB	15 x 72 x 36	125	175	28.25	\$891	N/A
A71HOCB	15 x 71.69 x 36	125	175	28.25	\$891	N/A
A66HOCB	15 x 66 x 36	125	164	26	\$852	N/A
A60HOCB	15 x 60 x 36	125	151	23.75	\$787	N/A

One fixed shelf and fixed shelf divider. Closed back features a grommet and flexible sweep for wire management. All hutches shipped pre-assembled. ***A71HOCB** for use when spanning 30" x 60/66" SPL/R and 20/24" x 42" FL/FR/L4/R4.

- Clearance from worksurface to valance is 17 3/4"; clearance from worksurface to hutch doors is 20".
- Woodgrain runs horizontal on both the upper and lower back panels.

A48HOCB	15 x 48 x 36	125	124	19	\$624	N/A
A42HOCB	15 x 42 x 36	125	111	16.75	\$624	N/A
A36HOCB	15 x 36 x 36	125	99	14.50	\$540	N/A
A30HOCB	15 x 30 x 36	125	88	12.25	\$501	N/A

One fixed shelf. Closed back features a grommet and flexible sweep for wire management. All hutches shipped pre-assembled.

- Clearance from worksurface to valance is 17 3/4"; clearance from worksurface to hutch doors is 20".
- Woodgrain runs horizontal on both the upper and lower back panels.

Required Specifications

Top finish
Base finish

Optional Specifications

Doors*

PIGEON-HOLE STORAGE

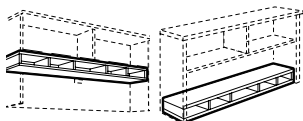

Horizontal Pigeon-Hole Storage

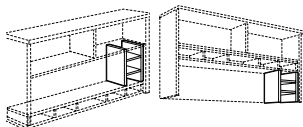

Vertical Pigeon-Hole Storage

MODEL#	DIMENSIONS	FREIGHT CLASS	WT/LBS.	CUBIC FT.	LIST PRICE	HP ADD
D x W x H						
AHS72	11.25 x 70 x 5.62	85	41	3	\$524	N/A
AHS71	11.25 x 69 x 5.62	70	43.50	2.30	\$524	N/A
AHS66	11.25 x 64 x 5.62	85	38	2.80	\$524	N/A
AHS60	11.25 x 58 x 5.62	85	35	2.50	\$429	N/A
AHS48	11.25 x 46 x 5.62	85	28	2	\$316	N/A
AHS42	11.25 x 40 x 5.62	85	24	2	\$316	N/A
AHS36	11.25 x 34 x 5.62	92.5	22	2	\$258	N/A

For additional storage. Can be **top** or **bottom** mounted. For use inside hutch. Shipped RTA (ready to assemble).

- **Cannot be used on A00S and C00S Overstorage Units.**
- Black finish is standard. Brushed Cobalt is available at no charge, please specify as **BRC**.

AVS14	11.25 x 13.37 x 14.37	85	13	.90	\$327	N/A
-------	-----------------------	----	----	-----	--------------	-----

For use in conjunction with the Horizontal Pigeon-Hole Storage. Can be used under or over horizontal unit. Shipped RTA (ready to assemble).

- Black finish is standard. Brushed Cobalt is available at no charge, please specify as **BRC**.

CORNER HUTCHES

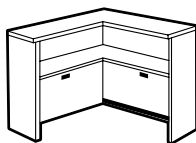

Corner Hutch with Closed Back

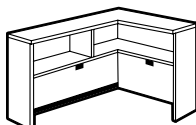

RIGHT Corner Hutch with Closed Back

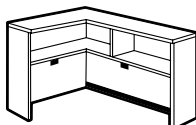

LEFT Corner Hutch with Closed Back

MODEL#	DIMENSIONS	FREIGHT CLASS	WT/LBS.	CUBIC FT.	LIST PRICE	HP ADD
A42CH	15 x 42 x 36	65	144	6.25	\$1051	N/A
A36CH	15 x 36 x 36	65	125	4.80	\$885	N/A

One fixed shelf. Closed back features a grommet in both back panels and flexible sweep for wire management. Shipped RTA (ready to assemble).

- Woodgrain runs horizontal on both the upper and lower back panels.

A3672CHR	15 x 36-72 x 36	65	186	7	\$1157	N/A
A3666CHR	15 x 36-66 x 36	65	177	7	\$1115	N/A

One fixed shelf and shelf divider on left side. Closed back features a grommet in both back panels and flexible sweep for wire management on the left side. Shipped RTA (ready to assemble).

- Woodgrain runs horizontal on both the upper and lower back panels.

A3672CHL	15 x 36-72 x 36	65	186	7.25	\$1157	N/A
A3666CHL	15 x 36-66 x 36	65	177	7.25	\$1115	N/A

One fixed shelf and shelf divider on right side. Closed back features a grommet in both back panels and flexible sweep for wire management on the right side. Shipped RTA (ready to assemble).

- Woodgrain runs horizontal on both the upper and lower back panels.

Required Specifications

Top finish
Base finish

Optional Specifications

Doors

HUTCH DOORS

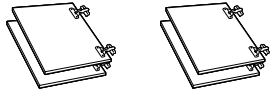

Four-Door Kit

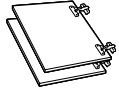

Two-Door Kit

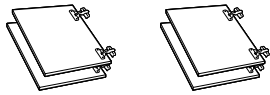

Corner Hutch Four-Door Kit

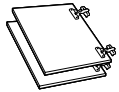

Corner Hutch Two-Door Kit

MODEL#	DIMENSIONS	FREIGHT CLASS	WT/LBS.	CUBIC FT.	LIST PRICE	HP ADD
--------	------------	---------------	---------	-----------	------------	--------

D x W x H

ADOOR72	.69 x 17.75 x 15	85	25	1.80	\$327	N/A
ADOOR71	.69 x 17.12 x 15	85	25	1.80	\$327	N/A
ADOOR66	.69 x 16.75 x 15	85	24	1.80	\$327	N/A
ADOOR60	.69 x 14.75 x 15	85	22	1.80	\$327	N/A

For use on 72", 71", 66" and 60"W straight hutches. Hinges included. Locks available, Add \$101 each lock. Doors for units 60" wide or more require two locks.

ADOOR48	.69 x 23.5 x 15	92.5	18	1.80	\$212	N/A
ADOOR42	.69 x 20.5 x 15	100	17	1.80	\$212	N/A
ADOOR36	.69 x 17.5 x 15	100	15	1.80	\$212	N/A
ADOOR30	.69 x 14.5 x 15	125	13	1.80	\$212	N/A

For use on 48", 42" 36" and 30"W straight hutches. Hinges included. Locks available, Add \$101 each lock. Doors for units 48" wide or less require one lock.

ADOOR72C	.69 x 56.5 x 15	70	27	1.80	\$416	N/A
ADOOR66C	.69 x 50.5 x 15	85	25	1.80	\$379	N/A

For use on 72" and 66"W corner hutches. Hinges included. Locks not available on corner hutch doors.

ADOOR42C	.69 x 26.5 x 15	92.5	20	1.80	\$360	N/A
ADOOR36C	.69 x 21.5 x 15	100	17	1.80	\$235	N/A

For use on 42" and 36"W corner hutches. Hinges included. Locks not available on corner hutch doors.

Required Specifications

Finish

TACKBOARDS FOR HUTCHES

MODEL# DIMENSIONS FREIGHT CLASS WT./LBS. CUBIC FT. FABRIC GRADE LIST PRICE

D x W x H

TACKBOARD Notes: Tackboards can be upholstered in all of the following fabrics:

Grade 1: Agate II, Hudson, Jenny, Quilt, Terrace, Urban, Waterfall

Grade 2: Couture, Crescent, Imprint, Lola, Match, Renewal, Replay, Silhouette

Grade 3: Anchorage, Brinx, Mariposa, Merge

Grade 4: Accent

Grade 5: Universe

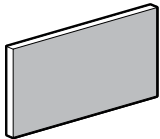

Tackboard

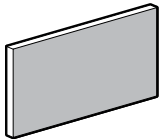

Tackboard

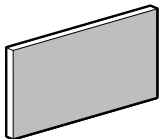

Tackboard

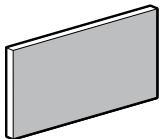

Tackboard

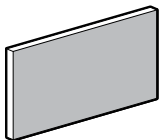

Tackboard

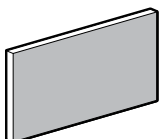

Tackboard

ATB7016	1 x 70 x 15	92.5	7	.65	1	\$322
					2	\$383
					3	\$427
					4	\$500
					5	\$575

For use on **A72HOCB** straight hutch. Includes mounting screws and covers.

ATB6916	1 x 69.5 x 15	92.5	7	.65	1	\$322
					2	\$383
					3	\$428
					4	\$500
					5	\$575

For use on **A71HOCB** straight hutch. Includes mounting screws and covers.

ATB6416	1 x 64 x 15	100	6.40	.65	1	\$317
					2	\$370
					3	\$412
					4	\$473
					5	\$544

For use on **A66HOCB** straight hutch. Includes mounting screws and covers.

ATB5816	1 x 58 x 15	92.5	5.80	.54	1	\$309
					2	\$363
					3	\$403
					4	\$468
					5	\$539

For use on **A60HOCB** straight hutch. Includes mounting screws and covers.

ATB4616	1 x 46 x 15	92.5	4.60	.43	1	\$215
					2	\$257
					3	\$287
					4	\$335
					5	\$386

For use on **A48HOCB** straight hutch. Includes mounting screws and covers.

ATB4016	1 x 40 x 15	100	4	.43	1	\$209
					2	\$244
					3	\$270
					4	\$313
					5	\$359

For use on **A42HOCB** straight hutch. Includes mounting screws and covers.

Required Specifications

Fabric

TACKBOARDS FOR HUTCHES

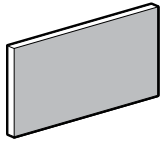

Tackboard

MODEL#	DIMENSIONS D x W x H	FREIGHT CLASS	WT/LBS.	CUBIC FT.	FABRIC GRADE	LIST PRICE
ATB3416	1 x 34 x 15	125	3.40	.43	1	\$202
					2	\$236
					3	\$263
					4	\$301
					5	\$348

For use on **A36HOCB** straight hutch. Includes mounting screws and covers.

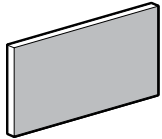

Tackboard

ATB2816	1 x 28 x 15	125	2.80	.43	1	\$195
					2	\$223
					3	\$244
					4	\$273
					5	\$316

For use on **A30HOCB** straight hutch. Includes mounting screws and covers.

TACKBOARDS FOR CORNER HUTCHES

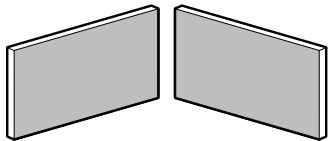

Tackboard

MODEL#	DIMENSIONS	FREIGHT CLASS	WT/LBS.	CUBIC FT.	LIST PRICE	HP ADD
ATB72CH	1 x 33-72 x 15 70 w x 15¾ h	125	9.94	1.30	1	\$498
					2	\$560
					3	\$605
					4	\$677
					5	\$778

For use on **A3672CHR/L corner** hutch. Includes mounting screws and covers.

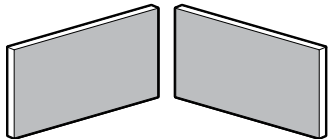

Tackboard

ATB66CH	1 x 33-64 x 15 64 w x 15¾ h	125	9.40	1.30	1	\$490
					2	\$543
					3	\$588
					4	\$648
					5	\$745

For use on **A3666CHR/L corner** hutch. Includes mounting screws and covers.

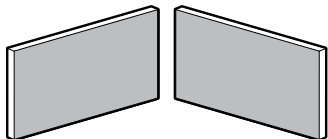

Tackboard

ATB42CH	1 x 39-40 x 15	100	7.70	.85	1	\$391
					2	\$428
					3	\$463
					4	\$511
					5	\$589

For use on **A42CH corner** hutch. Includes mounting screws and covers.

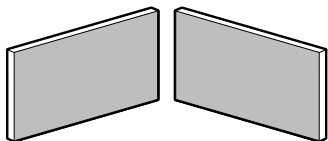

Tackboard

ATB36CH	1 x 33-34 x 15	125	6.60	.85	1	\$375
					2	\$411
					3	\$439
					4	\$492
					5	\$567

For use on **A36CH corner** hutch. Includes mounting screws and covers.

Required Specifications

Fabric - Tackboards
Finish - Transaction Top

WALL MOUNTED TACKBOARDS

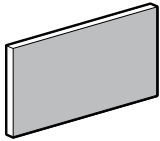

Wall Mounted Tackboard

MODEL# DIMENSIONS FREIGHT CLASS WT/LBS. CUBIC FT. FABRIC GRADE LIST PRICE

	D x W x H					
AWHT3019	1.25 x 30 x 19	125	6.30	1	1	\$250
					2	\$287
					3	\$331
					4	\$380
					5	\$436

For use under **A00S30** overstorage unit. Standard with pre-mounted "J" bracket for wall mount applications. There will be a 1.75" clearance between the top of the tackboard and bottom of the overhead, and a .25" clearance between the bottom of the tackboard and the worksurface.

- **NOTE:** Care should be taken to mount the units. Units should be mounted to wall studs using correct fasteners. Failure to do so may result in collapse of the unit and subsequent personal injury. **Mounting hardware not included.** Mounting hardware used should be based on wall material. Consult an installation professional for proper wall mounting.

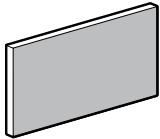

Wall Mounted Tackboard

AWHT3619	1.25 x 36 x 19	125	7.60	1	1	\$278
					2	\$320
					3	\$367
					4	\$422
					5	\$485

For use under **A00S36** overstorage unit. Standard with pre-mounted "J" bracket for wall mount applications. There will be a 1.75" clearance between the top of the tackboard and bottom of the overhead, and a .25" clearance between the bottom of the tackboard and the worksurface.

- **NOTE:** Care should be taken to mount the units. Units should be mounted to wall studs using correct fasteners. Failure to do so may result in collapse of the unit and subsequent personal injury. **Mounting hardware not included.** Mounting hardware used should be based on wall material. Consult an installation professional for proper wall mounting.

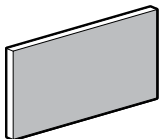

Wall Mounted Tackboard

AWHT4219	1.25 x 42 x 19	100	8.90	1	1	\$323
					2	\$371
					3	\$427
					4	\$490
					5	\$563

For use under **A00S42** overstorage unit. Standard with pre-mounted "J" bracket for wall mount applications. There will be a 1.75" clearance between the top of the tackboard and bottom of the overhead, and a .25" clearance between the bottom of the tackboard and the worksurface.

- **NOTE:** Care should be taken to mount the units. Units should be mounted to wall studs using correct fasteners. Failure to do so may result in collapse of the unit and subsequent personal injury. **Mounting hardware not included.** Mounting hardware used should be based on wall material. Consult an installation professional for proper wall mounting.

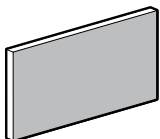

Wall Mounted Tackboard

AWHT4819	1.25 x 48 x 19	92.5	10.10	1	1	\$351
					2	\$403
					3	\$463
					4	\$533
					5	\$612

For use under **A00S48** overstorage unit. Standard with pre-mounted "J" bracket for wall mount applications. There will be a 1.75" clearance between the top of the tackboard and bottom of the overhead, and a .25" clearance between the bottom of the tackboard and the worksurface.

- **NOTE:** Care should be taken to mount the units. Units should be mounted to wall studs using correct fasteners. Failure to do so may result in collapse of the unit and subsequent personal injury. **Mounting hardware not included.** Mounting hardware used should be based on wall material. Consult an installation professional for proper wall mounting.

Required Specifications

Fabric

WALL MOUNTED TACKBOARDS

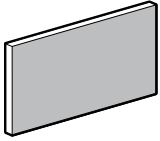

Wall Mounted Tackboard

MODEL#	DIMENSIONS D x W x H	FREIGHT CLASS	WT/LBS.	CUBIC FT.	FABRIC GRADE	LIST PRICE
AWHT6019	1.25 x 60 x 19	125	12.70	1.80	1	\$434
					2	\$500
					3	\$574
					4	\$661
					5	\$759

For use under **A00S60** overstorage unit. Standard with pre-mounted "J" bracket for wall mount applications. There will be a 1.75" clearance between the top of the tackboard and bottom of the overhead, and a .25" clearance between the bottom of the tackboard and the worksurface.

- **NOTE:** Care should be taken to mount the units. Units should be mounted to wall studs using correct fasteners. Failure to do so may result in collapse of the unit and subsequent personal injury. **Mounting hardware not included.** Mounting hardware used should be based on wall material. Consult an installation professional for proper wall mounting.

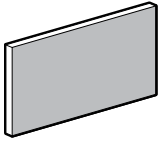

Wall Mounted Tackboard

AWHT6619	1.25 x 66 x 19	125	13.90	1.80	1	\$461
					2	\$531
					3	\$609
					4	\$701
					5	\$806

For use under **multiple** Adaptabilities wall mounted overstorage units. Standard with pre-mounted "J" bracket for wall mount applications. There will be a 1.75" clearance between the top of the tackboard and bottom of the overhead, and a .25" clearance between the bottom of the tackboard and the worksurface.

- **NOTE:** Care should be taken to mount the units. Units should be mounted to wall studs using correct fasteners. Failure to do so may result in collapse of the unit and subsequent personal injury. **Mounting hardware not included.** Mounting hardware used should be based on wall material. Consult an installation professional for proper wall mounting.

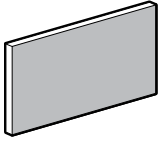

Wall Mounted Tackboard

AWHT7219	1.25 x 72 x 19	100	15.20	1.80	1	\$506
					2	\$581
					3	\$669
					4	\$770
					5	\$884

For use under **multiple** Adaptabilities wall mounted overstorage units. Standard with pre-mounted "J" bracket for wall mount applications. There will be a 1.75" clearance between the top of the tackboard and bottom of the overhead, and a .25" clearance between the bottom of the tackboard and the worksurface.

- **NOTE:** Care should be taken to mount the units. Units should be mounted to wall studs using correct fasteners. Failure to do so may result in collapse of the unit and subsequent personal injury. **Mounting hardware not included.** Mounting hardware used should be based on wall material. Consult an installation professional for proper wall mounting.

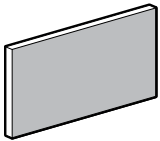

Wall Mounted Tackboard

AWHT7819	1.25 x 78 x 19	100	16.50	1.80	1	\$534
					2	\$613
					3	\$705
					4	\$811
					5	\$933

For use under **multiple** Adaptabilities wall mounted overstorage units. Standard with pre-mounted "J" bracket for wall mount applications. There will be a 1.75" clearance between the top of the tackboard and bottom of the overhead, and a .25" clearance between the bottom of the tackboard and the worksurface.

- **NOTE:** Care should be taken to mount the units. Units should be mounted to wall studs using correct fasteners. Failure to do so may result in collapse of the unit and subsequent personal injury. **Mounting hardware not included.** Mounting hardware used should be based on wall material. Consult an installation professional for proper wall mounting.

Required Specifications

Fabric

ACCESSORY PIECES

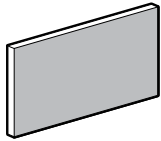

Wall Mounted Tackboard**

MODEL#	DIMENSIONS	FREIGHT CLASS	WT/LBS.	CUBIC FT.	LIST PRICE	HP ADD
	D x W x H					
AWHT8419	1.25 x 84 x 19	100	17.70	1.80	1	\$578
					2	\$666
					3	\$765
					4	\$880
					5	\$1012

For use under **multiple** Adaptabilities wall mounted overstorage units. Standard with pre-mounted "J" bracket for wall mount applications. There will be a 1.75" clearance between the top of the tackboard and bottom of the overhead, and a .25" clearance between the bottom of the tackboard and the worksurface.

- **NOTE:** Care should be taken to mount the units. Units should be mounted to wall studs using correct fasteners. Failure to do so may result in collapse of the unit and subsequent personal injury. **Mounting hardware not included.** Mounting hardware used should be based on wall material. Consult an installation professional for proper wall mounting.

ACCESSORY PIECES



Mixed Drawer Cabinet - LEFT*

MODEL#	DIMENSIONS	FREIGHT CLASS	WT/LBS.	CUBIC FT.	LIST PRICE	HP ADD
A2036MDL	20 x 36 x 29.5	92.5	162	15.50	\$1574	\$128
A2436MDL	24 x 36 x 29.5	100	176	18.25	\$1599	\$128

Two box drawers on **right**, one file drawer on **left** and one lateral file drawer on bottom. File on lateral file drawers locking. 1 pencil tray. Front-to-back filing bars.

- Black handles are standard. Silver is available at no charge, please specify as **SI**.
- To comply with ANSI/BIFMA stability tests, the Lateral File Counter Weight Kit, model "LFCWKIT36" on page 41 MUST be used.
- *File drawer construction is for accommodating hanging files NOT for stacking materials on the drawer bottom.*
- Top file drawer supports hanging folders only. Does not accept hanging folders with plastic tabs.



Mixed Drawer Cabinet - RIGHT*

A2036MDR	20 x 36 x 29.5	92.5	162	15.50	\$1574	\$128
A2436MDR	24 x 36 x 29.5	100	176	18.25	\$1599	\$128

Two box drawers on **left**, one file drawer on **right** and one lateral file drawer on bottom. File on lateral file drawers locking. 1 pencil tray. Front-to-back filing bars.

- Black handles are standard. Silver is available at no charge, please specify as **SI**.
- To comply with ANSI/BIFMA stability tests, the Lateral File Counter Weight Kit, model "LFCWKIT36" on page 41 MUST be used.
- *File drawer construction is for accommodating hanging files NOT for stacking materials on the drawer bottom.*
- Top file drawer supports hanging folders only. Does not accept hanging folders with plastic tabs.



Mixed Drawer Cabinet Shell - LEFT*

A2036MDLS	19.25 x 36 x 28.5	100	137	15	\$1535	N/A
A2436MDLS	23.25 x 36 x 28.5	100	150	18	\$1561	N/A

For use **under 29"H limited single pedestal desks, workstations or limited single pedestal credenzas. Unfinished top, no back.** Two box drawers on **right**, one file drawer on **left** and one lateral file drawer on bottom. File and lateral file drawers locking. 1 pencil tray. Front-to-back filing bars.

- Black handles are standard. Silver is available at no charge, please specify as **SI**.
- *File drawer construction is for accommodating hanging files NOT for stacking materials on the drawer bottom.*
- *For 24" deep worksurfaces, order **A2436MDLS**. For 20" deep worksurfaces, order **A2036MDLS**.*
- Top file drawer supports hanging folders only. Does not accept hanging folders with plastic tabs.

Required Specifications

Fabric**
Top finish*
Handle finish*
Base finish*

Optional Specifications

Key #*

ACCESSORY PIECES



Mixed Drawer Cabinet Shell - RIGHT

MODEL#	DIMENSIONS D x W x H	FREIGHT CLASS	WT/LBS.	CUBIC FT.	LIST PRICE	HP ADD
A2036MDRS	19.25 x 36 x 28.5	100	137	15	\$1535	N/A
A2436MDRS	23.25 x 36 x 28.5	100	150	18	\$1561	N/A

For use **under 29"H limited single pedestal desks, workstations or limited single pedestal credenzas. Unfinished top, no back.** Two box drawers on **left**, one file drawer on **right** and one lateral file drawer on bottom. File and lateral file drawers locking. 1 pencil tray. Front-to-back filing bars.

- Black handles are standard. Silver is available at no charge, please specify as **SI**.
- File drawer construction is for accommodating hanging files **NOT** for stacking materials on the drawer bottom.
- For 24" deep worksurfaces, order **A2436MDRS**. For 20" deep worksurfaces, order **A2036MDRS**.
- Top file drawer supports hanging folders only. Does not accept hanging folders with plastic tabs.

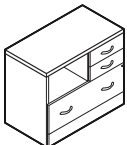

Mixed Storage Cabinet*

A2436MSC	24 x 36 x 29.5	100	163	18.25	\$1177	\$128
A2036MSC	20 x 36 x 29.5	100	147	15.50	\$1088	\$128

Features open storage compartment with access grommet on back. 2 box drawers and 1 lateral file drawer, all locking. 1 pencil tray. Front-to-back filing bars.

- To comply with ANSI/BIFMA stability tests, the Lateral File Counter Weight Kit, model "LFCWKIT36" on page 41 **MUST** be used.
- Black handles are standard. Silver is available at no charge, please specify as **SI**.
- File drawer construction is for accommodating hanging files **NOT** for stacking materials on the drawer bottom.

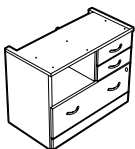

Mixed Storage Cabinet Shell

A2436MSCS	23.25 x 36 x 28	100	121	14.90	\$1147	N/A
A2036MSCS	19.25 x 36 x 28	125	136	17.45	\$1057	N/A

For use **under 29"H limited single pedestal desks, workstations or limited single pedestal credenzas. Unfinished top, no back.** Features open storage compartment with access grommet on back. 2 box drawers and 1 lateral file drawer, all locking. 1 pencil tray. Front-to-back filing bars.

- Black handles are standard. Silver is available at no charge, please specify as **SI**.
- File drawer construction is for accommodating hanging files **NOT** for stacking materials on the drawer bottom.
- For 24" deep worksurfaces, order **A2436MSCS**. For 20" deep worksurfaces, order **A2036MSCS**.



2 Drawer Lateral File*

A2036LF	20 x 36 x 29	100	145	15.50	\$973	\$128
---------	--------------	-----	-----	-------	--------------	--------------

Two full suspension drawers. Front-to-back and side-to-side letter/legal filing capability with lock. Anti-lock tilt suspension.

- To comply with ANSI/BIFMA stability tests, the Lateral File Counter Weight Kit, model "LFCWKIT36" on page 41 **MUST** be used.
- Black handles are standard. Silver is available at no charge, please specify as **SI**.
- File drawer construction is for accommodating hanging files **NOT** for stacking materials on the drawer bottom.

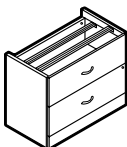

2 Drawer Lateral File Shell

A2436S2	24 x 36 x 28.5	125	114	18	\$1178	N/A
A2036S2	20 x 36 x 28.5	125	104	14.75	\$1178	N/A

For use **under 29"H limited single pedestal desks, workstations or limited single pedestal credenzas. No top or back.** Two full suspension locking drawers with **steel drawer interior**. Side-to-side file bars included. Anti-lock tilt suspension.

- Black handles are standard. Silver is available at no charge, please specify as **SI**.
- To prevent overloading, steel drawers do not include a back panel
- For 24" deep worksurfaces, order **A2436S2**. For 20" deep worksurfaces, order **A2036S2**.
- For front-to-back file bars order **FBB**, "FBB" on page 41.

Required Specifications

Top finish*
Base finish
Handles

Optional Specifications

Key #
HP laminate*

ACCESSORY PIECES

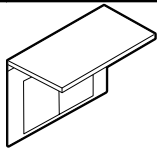

2 Drawer Lateral File Top and Back*

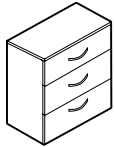

3 Drawer Lateral File*

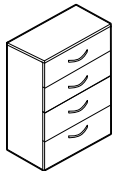

4 Drawer Lateral File*

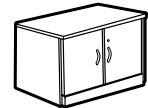

Storage Cabinet*

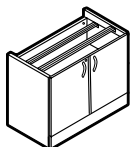

Storage Cabinet Shell

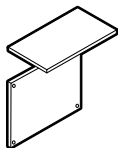

Storage Cabinet Top and Back*

MODEL#	DIMENSIONS	FREIGHT CLASS	WT/LBS.	CUBIC FT.	LIST PRICE	HP ADD
--------	------------	---------------	---------	-----------	------------	--------

D x W x H

ALF24TB	24 x 36 x 29.5	65	82	3.30	\$402	\$161
ALF20TB	20 x 36 x 29.5	65	78	3.30	\$402	\$161

For use with Lateral File Shell. Counterweights included. Shipped RTA (ready to assemble).

- Use **ALF24TB** for model A2436S2. Use **ALF20TB** for model A2036S2.

A2036S3	20 x 36 x 37.75	92.5	219	20	\$1693	\$128
---------	-----------------	------	-----	----	--------	-------

Three full suspension locking drawers with **steel drawer interior**. Side-to-side file bars included. Anti-lock tilt suspension.

- Black handles are standard. Silver is available at no charge, please specify as **SI**.
- For front-to-back file bars order **FBB**; See "FBB" on page 41.
- To prevent overloading, steel drawers do not include a back panel

A2036S4	20 x 36 x 49.5	92.5	267	25.75	\$2131	\$128
---------	----------------	------	-----	-------	--------	-------

Four full suspension locking drawers with **steel drawer interior**. Side-to-side file bars included. Anti-lock tilt suspension.

- Black handles are standard. Silver is available at no charge, please specify as **SI**.
- For front-to-back file bars order **FBB**; See "FBB" on page 41.
- To prevent overloading, steel drawers do not include a back panel

A2036SC	20 x 36 x 29.5	125	121	15.50	\$745	\$128
---------	----------------	-----	-----	-------	-------	-------

Self-closing hinged doors cover one adjustable shelf. Standard with lock.

- Black handles are standard. Silver is available at no charge, please specify as **SI**.

A2436SCS	23.25 x 36 x 28.5	150	106	18	\$643	N/A
A2036SCS	19.25 x 36 x 28.5	125	91	14.75	\$643	N/A

For use **under 29" H limited single pedestal desks, workstations or limited single pedestal credenzas. No top or back**. Self-closing hinged doors cover one adjustable shelf. Standard with lock.

- Black handles are standard. Silver is available at no charge, please specify as **SI**.
- For 24" deep worksurfaces, order **A2436SCS**. For 20" deep worksurfaces, order **A2036SCS**.

ASC24TB	24 x 36 x 29.5	85	49	3.30	\$272	\$161
ASC20TB	20 x 36 x 29.5	85	45	3.30	\$272	\$161

For use with **Storage Cabinet Shell**. Shipped RTA (ready to assemble).

- Use **ASC24TB** for model A2436SCS/MSCS; use **ASC20TB** for model A2036SCS/MSCS.

Required Specifications

Top finish*
Base finish
Handles

Optional Specifications

Key #
HP laminate*

ACCESSORY PIECES

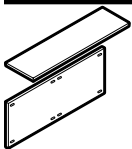

Credenza Top and Back

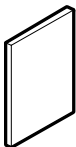

Full Leg



Personal Tower



Personal Tower



Vertical Storage/Lateral File Cabinet

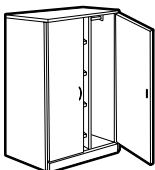

Storage Wardrobe Cabinet

MODEL#	DIMENSIONS D x W x H	FREIGHT CLASS	WT/LBS.	CUBIC FT.	LIST PRICE	HP ADD
A2472TB	24 x 72 x 29.5	70	95	6	\$557	\$278
A2072TB	20 x 72 x 29.5	85	87	6	\$557	\$266

For use with the following: **two Lateral File Shells**, or **two Storage Cabinet Shells**, or **two Mixed Storage Cabinet Shells**, or any combination. May also be used with **one Lateral File Shell plus one Full Leg**, or **one Storage Cabinet/Mixed Storage Cabinet Shell plus one Full Leg**. Shipped RTA (ready to assemble).

- For 24" deep worksurfaces, order **A2472TB**. For 20" deep worksurfaces, order **A2072TB**.

A24FL	24 x 1 x 28.5	92.5	20	1.70	\$195	N/A
A20FL	20 x 1 x 28.5	65	16	.60	\$195	N/A

For use at **either end of A24/2072TB Credenza Top and Back** to create a kneespace. Non-handed; can be used left or right. Shipped RTA (ready to assemble).

- For 24" deep worksurfaces, order **A24FL**. For 20" deep worksurfaces, order **A20FL**.

A24PTFF	24 x 24 x 65.5	100	219	27	\$1940	N/A
A20PTFF	20 x 24 x 65.5	100	198	22.75	\$1940	N/A

Includes 7" wardrobe section with a hanging rod; storage section with one adjustable shelf; and file section with **two file drawers**. Locks are keyed alike. Upper lock secures wardrobe and storage section. Lower lock secures both file drawers.

- Black handles are standard. Silver is available at no charge, please specify as **SI**.

A24PTBBF	24 x 24 x 65.5	125	213	27	\$1940	N/A
A20PTBBF	20 x 24 x 65.5	100	193	22.75	\$1940	N/A

Includes 7" wardrobe section with a hanging rod; storage section with one adjustable shelf; and file section with **box-box-file drawers**. Locks are keyed alike. Upper lock secures wardrobe and storage section. Lower lock secures all drawers.

- Black handles are standard. Silver is available at no charge, please specify as **SI**.

A3665VSL	20 x 36 x 65.5	100	273	33	\$1814	N/A
----------	----------------	-----	-----	----	---------------	-----

Contains storage area with one adjustable shelf behind a self-closing hinged door, plus two full suspension file drawers. Lateral file drawers lock.

- File drawer construction is for accommodating hanging files NOT for stacking materials on the drawer bottom.
- Black handles are standard. Silver is available at no charge, please specify as **SI**.

A2436DI	24 x 36 x 65.5	70	254	11.50	\$2243	N/A
A3665DI	20 x 36 x 65.5	70	237	11.50	\$1980	N/A

Includes 16" hanging rod on one side and four adjustable shelves on the other. Lock. Shipped RTA (ready to assemble).

- Black handles are standard. Silver is available at no charge, please specify as **SI**.

Required Specifications

Top finish
Base finish
Handles (only personal towers)

Optional Specifications

Key # (not credenzas or full leg)
HP laminate (tops and backs)

ACCESSORY PIECES

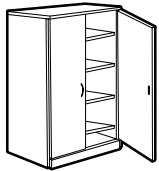

Storage Cabinet

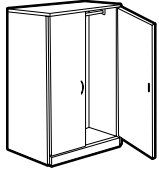

Wardrobe Cabinet



Printer Table

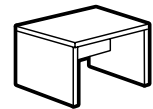

Magazine Table

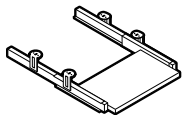

Pull-Out Keyboard

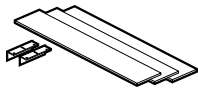

Counter Weight Kit

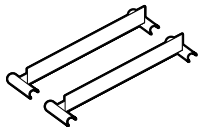

Front-to-Back Hanging File Bars

MODEL#	DIMENSIONS	FREIGHT CLASS	WT/LBS.	CUBIC FT.	LIST PRICE	HP ADD
--------	------------	---------------	---------	-----------	------------	--------

D x W x H

A2436SH	24 x 36 x 65.5	65	280	11.50	\$1975	N/A
A3665SH	20 x 36 x 65.5	65	261	11.50	\$1731	N/A

Includes four adjustable shelves. Lock. Shipped RTA (ready to assemble).

- Black handles are standard. Silver is available at no charge, please specify as **SI**.

A2436ROD	24 x 36 x 65.5	70	205	11.50	\$2138	N/A
A3665ROD	20 x 36 x 65.5	70	198	11.50	\$1814	N/A

Includes full width hanging rod. Lock. Shipped RTA (ready to assemble).

- Black handles are standard. Silver is available at no charge, please specify as **SI**.

A2430PT	24 x 30 x 29.5	65	108	4.30	\$745	\$128
---------	----------------	----	-----	------	--------------	--------------

Includes two fixed shelves, cut-back top shelf allows paper to fall onto lower shelf. Shipped RTA (ready to assemble).

A2248MT	22 x 48 x 18.5	85	61	4.30	\$416	\$182
A2222MT	22 x 22 x 18.5	85	40	3	\$334	\$96

Shipped RTA (ready to assemble).

APOKL28	17 x 28 x 3.5	85	13	.90	\$253	N/A
APOKL22	17 x 22 x 3.5	85	12	.90	\$228	N/A

Constructed of thermofused laminate. **APOKL28** will accommodate keyboard and mousepad. **APOKL28** will only fit on a single pedestal desk, freestanding table, or **A42205C**. Please specify color from available finishes listed on pg. 11.

- **APOKL28** will not fit extended corners or **A42245C**, **A36205C** 5-sided corners.

LFCWKIT36	6 x 33 x 1	60	40	.25	\$566	N/A
-----------	------------	----	----	-----	--------------	-----

3 metal plates. Plates mount to the underside of any 36" wide Lateral File or Mixed Storage/Drawer cabinet. Includes mounting hardware. Must be ordered separately. Field installed.

- To comply with ANSI/BIFMA stability tests, the Lateral File Counter Weight Kit MUST be used with the appropriate Lateral Files and Mixed Storage Cabinets.

FBB	-- x 15.2 x --	70	1	.10	\$18	
FBB-50	-- x 15.2 x --	60	50	.50	\$605	
FBB-100	-- x 15.2 x --	60	100	2.71	\$1110	

Includes two bars. Grey. FBB is one pair; FBB-50 is fifty pairs; FBB-100 is 100 pairs.

- Not recommended for "L" opening with receding door and roll-out shelves.

Required Specifications

Top finish
Base finish
Handles

Optional Specifications

Key #
HP laminate (only printer / magazine table)

A ADAPTABILITIES®

BOOKCASES

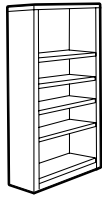

Bookcase - 72" High*

MODEL#	DIMENSIONS D x W x H	FREIGHT CLASS	WT/LBS.	CUBIC FT.	LIST PRICE	HP ADD
ABC72	12 x 36 x 72.5	125	170	23	\$891	N/A

One fixed heavy duty shelf and **three adjustable shelves**. Shipped fully assembled.

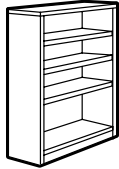

Bookcase - 65" High*

ABC65	12 x 36 x 65.5	125	150	21	\$870	N/A
-------	----------------	-----	-----	----	--------------	-----

One fixed heavy duty shelf and **two adjustable shelves**. Shipped fully assembled.

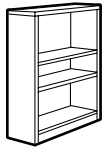

Bookcase - 48" High*

ABC48	12 x 36 x 48.5	125	116	15.75	\$663	N/A
-------	----------------	-----	-----	-------	--------------	-----

Two adjustable shelves. Shipped fully assembled.

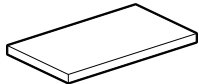

Bookcase Shelf

ABCSELF	12 x 34 x 1	100	13	1.50	\$166	N/A
---------	-------------	-----	----	------	--------------	-----

Extra shelf for bookcases. 1" thick.

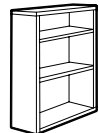

Table Top Bookcase

A3636TBC	15 x 36 x 36	125	111	17	\$569	N/A
----------	--------------	-----	-----	----	--------------	-----

ADOOR3636	.69 x 36 x 36	125	35	4.50	\$287	N/A
-----------	---------------	-----	----	------	--------------	-----

To be placed on top of 36" w lateral file or storage cabinet. Two adjustable shelves.

- For a set of doors, order **ADOOR3636**
- Locks available on ADOOR3636. Add \$101 each lock.

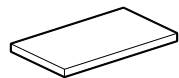

Bookcase Shelf

ATBC36SH	13.25 x 34 x 1	100	16	1.70	\$158	N/A
----------	----------------	-----	----	------	--------------	-----

Extra shelf for TABLE TOP bookcases. 1" thick.

Required Specifications

Top finish*
Base finish*

END SHELVES

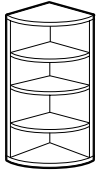

End Shelf - 65" High

MODEL#	DIMENSIONS D x W x H	FREIGHT CLASS	WT/LBS.	CUBIC FT.	LIST PRICE	HP ADD
A2465ESHL	24 x 24 x 65.5	65	136	5	\$936	N/A
A2065ESHL	20 x 20 x 65.5	65	113	5	\$787	N/A
A2465ESHR	24 x 24 x 65.5	65	136	5	\$936	N/A
A2065ESHR	20 x 20 x 65.5	65	113	5	\$787	N/A

For use at end of **wardrobe/storage, vertical storage cabinets, and personal towers**. Four fixed shelves. Shipped RTA (ready to assemble). **Specify left or right.**

- For 24" deep cabinet, order **A2465ESH**. For 20" deep cabinet, order **A2065ESH**.

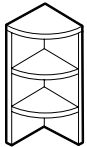

End Shelf - 36" High

A1536ESHL	15 x 15 x 36	85	44	3.30	\$379	N/A
A1536ESHR	15 x 15 x 36	85	44	3.30	\$379	N/A

For use at end of **hutches**. Two fixed shelves. To be used on top of **A3029ESHL/R, A2429ESHL/R or A2029ESHL/R**. Shipped RTA (ready to assemble). **Specify left or right.**

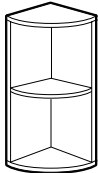

End Shelf - 29" High

A3029ESHL	30 x 30 x 29.5	70	104	5.25	\$663	\$214
A2429ESHL	24 x 24 x 29.5	70	77	4.30	\$540	\$108
A2029ESHL	20 x 20 x 29.5	70	60	3.80	\$460	\$86
A3029ESHR	30 x 30 x 29.5	70	104	5.25	\$663	\$214
A2429ESHR	24 x 24 x 29.5	70	77	4.30	\$540	\$108
A2029ESHR	20 x 20 x 29.5	70	60	3.80	\$460	\$86

For use at end of **worksurfaces**. Two fixed shelves. Shipped RTA (ready to assemble). **Specify left or right.**

- For 30" deep worksurface, order **A3029ESH**. For 24" deep worksurface, order **A2429ESH**.
For 20" deep worksurface, order **A2029ESH**.

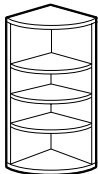

End Shelf - 49 1/2" High

A2049ESHL	20 x 20 x 49.5	65	94	3.80	\$693	N/A
A2049ESHR	20 x 20 x 49.5	65	94	3.80	\$693	N/A

For use at end of **A2036S4 4-high lateral file**. Four fixed shelves. Shipped RTA (ready to assemble). **Specify left or right.**

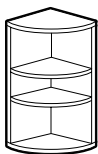

End Shelf - 37 1/4" High

A2037ESHL	20 x 20 x 38.2	70	77	5	\$504	N/A
A2037ESHR	20 x 20 x 38.2	70	77	5	\$504	N/A

For use at end of **A2036S3 3-high lateral file**. Three fixed shelves. Shipped RTA (ready to assemble). **Specify left or right.**

Required Specifications

Top finish
Base finish

Optional Specifications

HP Laminate (End Shelf, 29"h)

A ADAPTABILITIES®

PEDESTALS



Freestanding Pedestal

MODEL#	DIMENSIONS D x W x H	FREIGHT CLASS	WT/LBS.	CUBIC FT.	LIST PRICE	HP ADD
AFPBBF19	19 x 16 x 28.5	100	68	7.25	\$811	N/A
AFPBBF22	22 x 16 x 28.5	100	72	8.25	\$831	N/A
AFPBBF28	28 x 16 x 28.5	100	88	10.25	\$864	N/A

For use under a freestanding worksurface (20", 24" or 30"); attaches to worksurface top. No top and unfinished back. Two box and one file drawer. One pencil tray. File drawer and lower box drawer are locking.

- *Cannot be used with **A2466** extended corners.*
- *When used with Connectable Tables (e.g. A2472T) bottom rear of pedestal will show because of the modesty on table units*

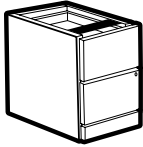

Freestanding Pedestal

AFPPF19	19 x 16 x 28.5	100	67	7.25	\$878	N/A
AFPPF22	22 x 16 x 28.5	100	75	8.25	\$890	N/A
AFPPF28	28 x 16 x 28.5	100	89	10.25	\$939	N/A

For use under a freestanding worksurface (20", 24" or 30"); attaches to worksurface top. No top and unfinished back. Two file drawers. Locking.

- *Cannot be used with **A2466** extended corners.*
- *When used with Connectable Tables (e.g. A2472T) bottom rear of pedestal will show because of the modesty on table units*

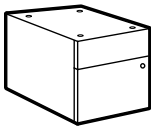

Hanging Pedestal

AHPBF18	18 x 16 x 18	92.5	48	4.50	\$566	N/A
---------	--------------	------	----	------	--------------	-----

For use under a freestanding worksurface (20", 24" or 30"); attaches to worksurface top. No top and unfinished back. One box and one file drawer. One pencil tray. Locking. 18" high.

- *Cannot be used with **A2466** extended corners.*
- *When used with Connectable Tables (e.g. A2472T) bottom rear of pedestal will show because of the modesty on table units*



Mobile Pedestal*

AMPBBF19	19 x 16 x 28	85	96	6.50	\$847	\$161
AMPBBF22	23 x 16 x 28	92.5	92	7.75	\$856	\$159
AMPBBF28	29 x 16 x 28	92.5	105	9.50	\$890	\$161

Pedestal on casters. Front casters lock. Fits under worksurfaces and is easily moved. Two box and one file drawer. One pencil tray. File drawer and lower box drawer are locking. Includes counterweight to prevent tipping.

- *Cannot be used with **A2466** extended corners.*

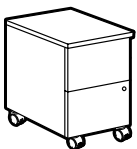

Mobile Pedestal*

AMPFF19	19 x 16 x 28	85	97	6.50	\$912	\$161
AMPFF22	23 x 16 x 28	85	95	7.75	\$925	\$161
AMPFF28	29 x 16 x 28	92.5	106	9.50	\$973	\$161

Pedestal on casters. Front casters lock. Fits under worksurfaces and is easily moved. Two file drawers. Locking. Includes counterweight to prevent tipping.

- *Cannot be used with **A2466** extended corners.*

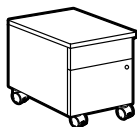

Mobile Pedestal*

AMPBF19	19 x 16 x 22	85	77	5.25	\$745	\$161
AMPBF22	23 x 16 x 22	85	73	6	\$763	\$161
AMPBF28	29 x 16 x 22	92.5	83	7.50	\$783	\$161

Pedestal on casters. Front casters lock. Fits under worksurfaces and is easily moved. One box and one file drawer. One pencil tray. Locking. 22" high. Includes counterweight to prevent tipping.

Required Specifications

Top finish
Base finish*

Optional Specifications

Key #
HP laminate (mobile pedestal)
Handle

BOARDROOM TABLES

MODEL#	DIMENSIONS	FREIGHT CLASS	WT/LBS.	CUBIC FT.	LIST PRICE	HP ADD
--------	------------	---------------	---------	-----------	------------	--------

D x W x H

A48R	48 x 48 x 1.5	85	95	7.50	\$482	\$373
A42R	42 x 42 x 1.5	85	73	5.75	\$460	\$373
A36R	36 x 36 x 1.5	92.5	54	4.90	\$334	\$214



Boardroom Table - Round Top*

A48R may be used with four monoposts. **A36R** and **A42R** may be used only with cross base or drum base.

- Available with the **Bicut Edge** at no upcharge. Please Specify "**CR**".
- **A48R** to be used with four monopost legs only, model **A5L**.
- **A42R** to be used with four monoposts (**A5L**) or cross base **A2727XB**
- **A36R** to be used with four monoposts (**A5L**), drum base **A18Z** or cross base **A2727XB**

A48120RE	48 x 120 x 1.5	70	274	13	\$1034	\$851
A4896RE	48 x 96 x 1.5	65	314	11.50	\$787	\$692
A3672RE	36 x 72 x 1.5	65	175	7	\$580	\$399



Boardroom Table - Rectangular Top*

For use with two drum bases, two "V" bases, one panel base OR four monoposts. Predrilled for "V" base and panel base.

Top comes in one piece, except for A48120RE (two pieces)

- Available with the **Bicut Edge** at no upcharge. Please Specify "**CR**".
- **A48120RE** uses three drum bases, three "V" bases, one double panel base OR six monoposts.

A48144B	48 x 144 x 1.5	60	237	7.50	\$1198	\$1010
A48120B	48 x 120 x 1.5	60	198	6.30	\$1034	\$851
A4896B	48 x 96 x 1.5	70	193	9.80	\$811	\$692



Boardroom Table - Boat Shape Top*

For use with three drum bases, three "V" bases, one double panel base OR six monoposts. Predrilled for "V" base and panel base. **Top comes in two pieces, except for A4896B.**

- Available with the **Bicut Edge** at no upcharge. Please Specify "**CR**".
- **A4896B** uses two drum bases, two "V" bases, one panel base OR four monoposts.

A48144RT	48 x 144 x 1.5	60	251	7.50	\$1198	\$1010
A48120RT	48 x 120 x 1.5	60	204	6.30	\$1034	\$851
A4896RT	48 x 96 x 1.5	70	200	9.80	\$811	\$692
A3672RT	36 x 72 x 1.5	70	112	5.80	\$624	\$399



Boardroom Table - Racetrack Top*

For use with three drum bases, three "V" bases, one double panel base OR six monoposts. Predrilled for "V" base and panel base. **Top comes in two pieces except for A4896RT and A3672RT.**

- Available with the **Bicut Edge** at no upcharge. Please Specify "**CR**".
- **NOTE:** 48" x 120" and 48" x 144" woodgrain finish Adaptabilities tables will not have a perfect match of grain at the center where the two halves meet.
- **A4896RT** and **A3672RT** use two drum bases, two "V" bases, one panel base OR four monoposts.

A2727XB	27 x 27 x 28.5	70	63	3.60	\$309	N/A
---------	----------------	----	----	------	-------	-----

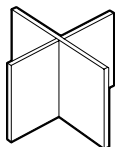

Cross Base

Use as the base for **36" or 42" round tops (model A36R or A42R)**. Shipped RTA (ready to assemble).

A1616V	16 x 16 x 28.5	60	39	1.10	\$263	N/A
A1616V2	16 x 16 x 28.5	60	74	1.10	\$520	N/A

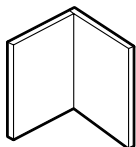

"V" Base

Use as the base for **rectangular, boat shaped or racetrack tops**. Shipped RTA (ready to assemble).

- **A1616V2** is shipped 2 bases per carton.

Required Specifications

Finish
Edge detail*

Optional Specifications

HP laminate*

A ADAPTABILITIES®

BOARDROOM TABLES

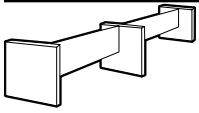

Panel Base

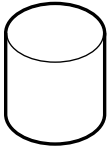

Drum Base

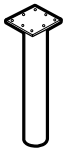

Mono Post

MODEL#	DIMENSIONS	FREIGHT CLASS	WT./LBS.	CUBIC FT.	LIST PRICE	HP ADD
--------	------------	---------------	----------	-----------	------------	--------

D x W x H

A2488PB	24 x 88 x 28.5	70	119	6	\$828	N/A
A2445PB	24 x 45 x 28.5	70	76	4.30	\$540	N/A

Use as the base for **rectangular, boat shaped or racetrack tops**. Shipped RTA (ready to assemble).

- Use **A2488PB** for 120 - 144" wide tops.
- Use **A2445PB** for 72 - 96" wide tops.

A18Z	18 x 18 x 28.5	250	29	7.50	\$580	N/A
------	----------------	-----	----	------	--------------	-----

Use as the base for **36" or 42" round tops (model A36R or A42R)** and **72", 96", 120" or 144" wide tops**. Available in **Black finish only**.

- All Drum Bases require approx. 125 lb. of sand in each base for adequate stability. Sand not included.

A5L	5 x 5 x 28.5	100	13	1.50	\$253	N/A
-----	--------------	-----	----	------	--------------	-----

Use as the base for **48" (model A48R) round tops** and **72", 96", 120" or 144" wide tops**.

- Post is shipped in separate carton. Standard in Black; Silver is available at no charge, please specify **SI**.

BOARDROOM ACCESSORIES



Serving Cart*



Serving Cart*

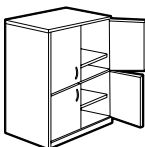

Audio/Visual Cabinet*

MODEL#	DIMENSIONS	FREIGHT CLASS	WT./LBS.	CUBIC FT.	LIST PRICE	HP ADD
--------	------------	---------------	----------	-----------	------------	--------

A2036SK	20 x 36 x 36.5	100	179	19	\$1731	\$128
---------	----------------	-----	-----	----	---------------	--------------

Includes **two** side opening, self-closing hinged doors, **two box drawers**, one slide-out tray and storage shelf. On casters.

- Available with the **Bicut Edge** at no upcharge. Please Specify "**AR**".
- Black handles are standard. Silver is available at no charge, please specify as **SI**.

A2020SK	20 x 20 x 36	92.5	114	11	\$1086	\$86
---------	--------------	------	-----	----	---------------	-------------

Includes **one** side opening, self-closing hinged door, **one box drawer**, one slide-out tray and storage shelf. On casters.

- Available with the **Bicut Edge** at no upcharge. Please Specify "**CR**".
- Black handles are standard. Silver is available at no charge, please specify as **SI**.

A2436AV	24 x 36 x 65.5	65	272	11.25	\$1980	N/A
---------	----------------	----	-----	-------	---------------	-----

Includes **four** side opening doors covering two adjustable and two fixed shelves. Wire access through one grommet on back panel. Holds up to 27"H TV monitor. Shipped RTA (ready to assemble).

- Black handles are standard. Silver is available at no charge, please specify as **SI**.

Required Specifications

Top finish *
Base finish
Handles*

Optional Specifications

Key #*
HP laminate*

BOARDROOM ACCESSORIES

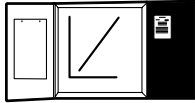

Visual Board

MODEL#	DIMENSIONS	FREIGHT CLASS	WT./LBS.	CUBIC FT.	LIST PRICE	HP ADD
	D x W x H					
AVB4848	4 x 48 x 48	70	135	9	\$1240	N/A

Includes white board and two side opening doors containing cork board on right door and 50-sheet paper writing pad on left door. Marker board can be used for projection. Set of 4 dry markers and eraser included.

• **NOTE:** Care should be taken to mount the units. Units should be mounted to wall studs using correct fasteners. Failure to do so may result in collapse of the unit and subsequent personal injury. Mounting hardware not included. Mounting hardware used should be based on wall material. Consult an installation professional for proper wall mounting.

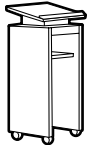

Lectern*

A1844LC	18 x 24 x 44	70	92	4.80	\$663	\$86
---------	--------------	----	----	------	--------------	-------------

Features angled stand, storage shelf and casters. Shipped RTA (ready to assemble).

Required Specifications

Top finish
Base finish

Optional Specifications

HP laminate*



The **Genoa**® series combines the value of laminate furniture with the contemporary styling of top over end panel design. This versatile offering of components and wide selection of laminate finish options is the perfect complement to any office environment.

For added security of confidential material, all desks and credenzas are equipped with one locking pedestal. Genoa's kneespace credenza easily accommodates a computer, books, binders and files to maximize space.

Genoa features quality construction with the added strength of dovetailed box and file drawers. Fully progressive ball bearing suspensions ensure years of smooth, trouble-free drawer service.

Genoa's classic styling and simplicity integrate easily with existing furnishings and any interior decor. For new offices or current office expansions, Genoa is clearly the affordable and practical choice.

Features and Benefits

- 45lb. density particle board substructure with high performance thermally fused laminate
- Available bow front desk provides extra legroom and work area for visitors
- ¾ modesty panel is standard
- Most components shipped fully assembled, 1 per carton
- Pencil tray included in box drawer
- Box drawers mounted on ¾ extension steel ball bearings
- All drawers feature French dovetail joint in front and lapjoint in back
- Drawers open with side pull
- Compatible with **Divide** panel system for increased privacy and storage requirements

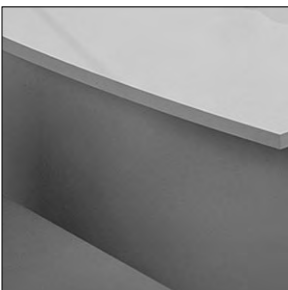

Bow front available on 36" x 72" desks



Contemporary top-over-end panel design



Drawer fronts are edge banded on all sides

GENERAL INFORMATION

- Constructed of 45 lb. density particle board with high performance thermally fused laminate
- Genoa components are compatible with **Divide** partitioning panels.
- Large offering of extended corners, full to floor pedestals, islands and storage options
- Double wall pedestal housing
- Genoa desk and storage products have been tested and comply with all BIFMA mechanical tests.
- GREENGUARD INDOOR AIR QUALITY CERTIFICATION - Global laminate and seating products are in compliance with stringent emission guidelines set out by the Greenguard Environmental Institute under the standards for low emitting products and materials. www.greenguard.org.
- **Level 3 Certified**

CONSTRUCTION

- 1" worksurfaces constructed of 45 lb. density particleboard with high performance thermally fused laminate
- Double wall pedestal housing
- Panel end style with top over side panel design
- 1" adjustable leveling glides standard on all units
- Standard with locks

MODESTY PANELS

- Recessed ¾ height modesty panel is standard. Full modesty panel available. **Add \$55.**
- All full to floor units, bridges and returns are standard with a full modesty panel

STORAGE

- All lateral file drawer fronts feature the woodgrain running in a horizontal direction
- Pencil tray included in box drawer
- All drawers feature French dovetail joint in front and lapjoint in back

FINISHES

ACJ	Absolute Acajou	HGT	Hayden Grey
ASN	Asian Night	OTM	Quartered Mahogany
AWC	Avant Cherry	SOG	Storm Grey
AWH	Avant Honey	TFW	Tiger Fruitwood
BLK	Black	TWL	Tiger Walnut
BRC	Brushed Cobalt	WHE	Walnut Heights
CMB	Clear Maple	WHC	White Chocolate
DES	Dark Espresso	WCR	Winter Cherry
DWT	Designer White	WGY	Willow Grey

GROMMETS

- Grommets may be ordered on Genoa hutch back panel
- Additional grommets available in standard worksurface locations (left, center or right). Order as: **AG1, AG2 or AG3. Add \$69.**
- Grommet hole dimensions are 3 ¼" wide x 1 7/8" deep



- Actual grommet locations on the worksurface are depicted in the example drawings shown below. Dimensions shown are actual measurements (in inches).

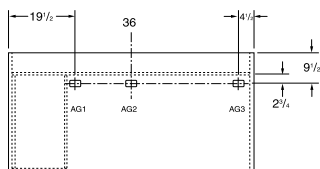

36 x 72 single pedestal left desks (3672SPL)

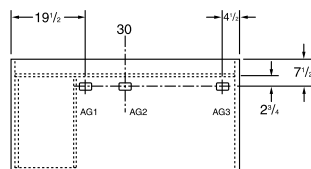

30 x 60 single pedestal left desks (3060SPL)

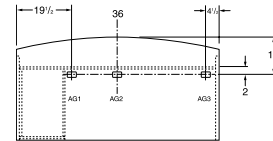

36 x 72 single pedestal left bow top desks (3672SLB)

- Grommets may be placed at non-standard locations. Order as: **AGS - Add \$69.** A drawing must be supplied with vertical and horizontal dimensions to the center of the cut-out (as in drawing above). Please refer to CUSTOM GROMMET LOCATION FORM in the back reference section.
- Components that come standard with grommet may be ordered without a grommet. **Add \$37.**
- Grommets are available on modesty panels of **5-sided corners** 6 ½" in where the two modesty panels meet at a 90°angle. Please specify **FOGMPR** for right grommet placement and **FOGMPL** for left grommet (placement is as shown on diagrams below). Cost is **\$69.**

*Modesty Panels are 1" off of ground

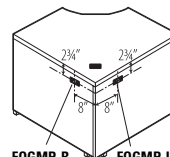

5-Sided Corner Unit

POWER BLOCK

- A Power Block (model **PMSPDM**) may be ordered on all worksurfaces
- A Power Block is a rectangular worksurface power/data module with one electrical duplex receptacle and two data (RJ45) receptacles. 9 foot black cord included. Power Block dimensions are 3 ½" deep x 6 ½" wide x 2 ¾" high.
- To purchase a Power Block, you must specify both the Power Block cut-out location and the Power Block model #. Order Power Block as **PMSPDM, Add \$261.** Power Blocks are available in standard worksurface locations (left, center or right). Order as **E1, E2 or E3. Add \$69.**

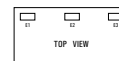

Power Block **PMSPDM. Add \$261** Specify location **E1, E2 or E3. Add \$69.**

DOUBLE PEDESTAL DESKS

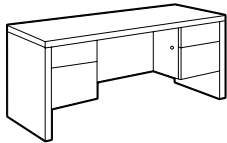

Double Pedestal Desk

MODEL#	DIMENSIONS D x W x H	FREIGHT CLASS	WT/LBS.	CUBIC FT.	LIST PRICE
G3672DP	36 x 72 x 29	150	286	50.50	\$1034
G3072DP	30 x 72 x 29	150	245	43.75	\$1007
G3066DP	29.69 x 66 x 29	150	235	39.25	\$978
G3060DP	29.69 x 60 x 29	125	226	35.50	\$820

Standard with box/file pedestals on both sides. Pedestals lock. One pencil tray.

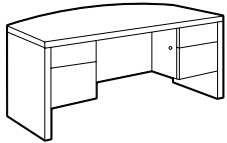

Double Pedestal Bow Top Desk

G3672DPB	32-36 x 72 x 29	150	256	50.50	\$1269
----------	-----------------	-----	-----	-------	---------------

Standard with box/file pedestals on both sides and bow top. Pedestals lock. One pencil tray.

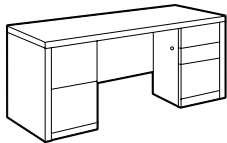

Full to Floor Double Pedestal Desk

G3072D4	29.69 x 72 x 29	125	277	43.75	\$1320
---------	-----------------	-----	-----	-------	---------------

Standard with full to floor box/file on right pedestal and file/file on left pedestal. Pedestals lock. One pencil tray.

SINGLE PEDESTAL DESKS

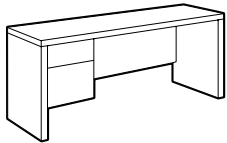

Single Pedestal Desk - LEFT

G3672SPL	36 x 72 x 29	150	235	50.50	\$940
G3072SPL	30 x 72 x 29	150	192	43.75	\$891
G3066SPL	29.69 x 66 x 29	150	192	39.25	\$876
G3060SPL	29.69 x 60 x 29	150	183	35.50	\$725
G3048SPL	29.69 x 48 x 29	150	166	28.75	\$725
G2445SPL	24 x 45 x 29	150	137	23.50	\$566

Standard with box/file pedestal. Pedestal locks. One pencil tray. Pedestal is on the **left**.

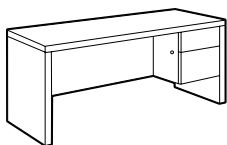

Single Pedestal Desk - RIGHT

G3672SPR	36 x 72 x 29	150	235	50.50	\$940
G3072SPR	30 x 72 x 29	150	192	43.75	\$891
G3066SPR	29.69 x 66 x 29	150	192	39.25	\$876
G3060SPR	29.69 x 60 x 29	150	183	35.50	\$725
G3048SPR	29.69 x 48 x 29	150	166	28.75	\$725
G2445SPR	24 x 45 x 29	150	137	23.50	\$566

Standard with box/file pedestal. Pedestal locks. One pencil tray. Pedestal is on the **right**.

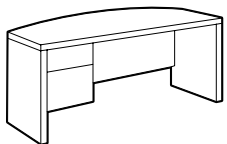

Single Pedestal Bow Top Desk - LEFT

G3672SLB	32-36 x 72 x 29	150	270	50	\$1161
----------	-----------------	-----	-----	----	---------------

Standard with box/file pedestal on **left** and bow top. Pedestal locks. One pencil tray.

Required Specifications

Finish

Optional Specifications

Full modesty
Grommet
Key #

Accessories

Power block
Keyboard tray
Pencil tray

SINGLE PEDESTAL DESKS

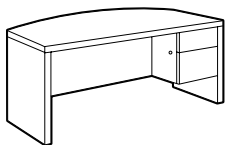

Single Pedestal Bow Top Desk - RIGHT

MODEL# DIMENSIONS FREIGHT CLASS WT/LBS. CUBIC FT. LIST PRICE

D x W x H

G3672SRB	36 x 72 x 29	150	270	50	\$1161
----------	--------------	-----	-----	----	---------------

Standard with box/file pedestal on **right** and bow top. Pedestal locks. One pencil tray.

RETURNS

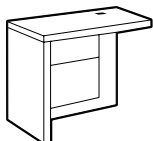

Typing Return - LEFT

G2448SDL	24 x 48 x 26	150	137	23.50	\$583
G2040SDL	20 x 40 x 26	125	111	17.50	\$566

Standard with box/file pedestal and lower **26" height**. Pedestal locks. Grommet in worksurface. Pedestal is on the **left**.

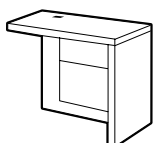

Typing Return - RIGHT

G2448SDR	24 x 48 x 26	150	137	23.50	\$583
G2040SDR	20 x 40 x 26	125	111	17.50	\$566

Standard with box/file pedestal and lower **26" height**. Pedestal locks. Grommet in worksurface. Pedestal is on the **right**.

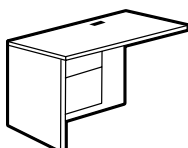

Flush Return - LEFT

G2454FL	24 x 54 x 29	150	127	27	\$709
G2448FL	24 x 48 x 29	125	142	23.50	\$629
G2442FL	24 x 42 x 29	150	111	21.50	\$606
G2054FL	20 x 54 x 29	150	114	23	\$709
G2048FL	20 x 48 x 29	150	107	20.50	\$629
G2042FL	20 x 42 x 29	150	100	18	\$606
G2040FL	20 x 40 x 29	125	115	17.50	\$598
G2036FL	20 x 36 x 29	125	93	15.50	\$598

Standard with box/file drawer pedestal. Pedestal locks. Grommet in worksurface. Pedestal is on the **left**.

- For 24" deep worksurfaces, order **G24__FL**. For 20" deep worksurfaces, order **G20__FL**.
- Keyboard and pencil trays for use on units 42" and above

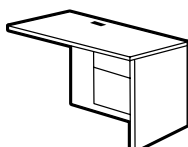

Flush Return - RIGHT

G2454FR	24 x 54 x 29	150	127	27	\$709
G2448FR	24 x 48 x 29	125	142	23.50	\$629
G2442FR	24 x 42 x 29	150	111	21.50	\$606
G2054FR	20 x 54 x 29	150	114	23	\$709
G2048FR	20 x 48 x 29	150	107	20.50	\$629
G2042FR	20 x 42 x 29	150	100	18	\$606
G2040FR	20 x 40 x 29	125	115	17.50	\$598
G2036FR	20 x 36 x 29	125	93	15.50	\$598

Standard with box/file drawer pedestal. Pedestal locks. Grommet in worksurface. Pedestal is on the **right**.

- For 24" deep worksurfaces, order **G24__FR**. For 20" deep worksurfaces, order **G20__FR**.
- Keyboard and pencil trays for use on units 42" and above

Required Specifications

Finish

Optional Specifications

Key #

Accessories

- Power block
- Keyboard tray
- Pencil tray

RETURNS

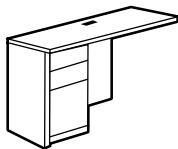

Full to Floor Flush Return - LEFT

MODEL#	DIMENSIONS D x W x H	FREIGHT CLASS	WT./LBS.	CUBIC FT.	LIST PRICE
G2448BL4	24 x 48 x 29	150	136	25	\$913
G2442BL4	24 x 42 x 29	150	128	21.50	\$901
G2436BL4	24 x 36 x 29	125	120	18	\$882
G2048BL4	20 x 48 x 29	150	121	20.50	\$890
G2042BL4	20 x 42 x 29	125	114	18	\$867
G2036BL4	20 x 36 x 29	125	108	15.50	\$852

Standard with box/box/file drawer pedestal. Lower box drawer and file drawer lock. Grommet in worksurface. Pedestal is on the **left**.

- For 24" deep worksurfaces, order **G24__BL4**. For 20" deep worksurfaces, order **G20__BL4**.
- Keyboard and pencil trays for use on units 42" and above

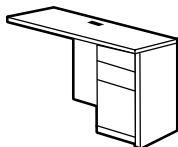

Full to Floor Flush Return - RIGHT

G2448BR4	24 x 48 x 29	150	136	25	\$913
G2442BR4	24 x 42 x 29	150	128	21.50	\$901
G2436BR4	24 x 36 x 29	125	120	18	\$882
G2048BR4	20 x 48 x 29	150	121	20.50	\$890
G2042BR4	20 x 42 x 29	125	114	18	\$867
G2036BR4	20 x 36 x 29	125	108	15.50	\$852

Standard with box/box/file drawer pedestal. Lower box drawer and file drawer lock. Grommet in worksurface. Pedestal is on the **right**.

- For 24" deep worksurfaces, order **G24__BR4**. For 20" deep worksurfaces, order **G20__BR4**.
- Keyboard and pencil trays for use on units 42" and above

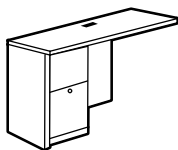

Full to Floor Flush Return - LEFT

G2448L4	24 x 48 x 29	150	132	25	\$940
G2442L4	24 x 42 x 29	150	124	21.50	\$922
G2436L4	24 x 36 x 29	125	116	18	\$907
G2048L4	20 x 48 x 29	150	118	20.50	\$913
G2042L4	20 x 42 x 29	125	111	18	\$890
G2036L4	20 x 36 x 29	125	104	15.50	\$876

Standard with file/file drawer pedestal. Pedestal locks. Grommet in worksurface. Pedestal is on the **left**.

- For 24" deep worksurfaces, order **G24__L4**. For 20" deep worksurfaces, order **G20__L4**.
- Keyboard and pencil trays for use on units 42" and above

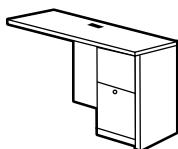

Full to Floor Flush Return - RIGHT

G2448R4	24 x 48 x 29	150	132	25	\$940
G2442R4	24 x 42 x 29	150	124	21.50	\$922
G2436R4	24 x 36 x 29	125	116	18	\$907
G2048R4	20 x 48 x 29	150	118	20.50	\$913
G2042R4	20 x 42 x 29	125	111	18	\$890
G2036R4	20 x 36 x 29	125	104	15.50	\$876

Standard with file/file drawer pedestal. Pedestal locks. Grommet in worksurface. Pedestal is on the **right**.

- For 24" deep worksurfaces, order **G24__R4**. For 20" deep worksurfaces, order **G20__R4**.
- Keyboard and pencil trays for use on units 42" and above

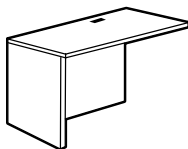

Flush Return - LEFT

G2454EL	24 x 54 x 29	70	87	5.25	\$583
G2448EL	24 x 48 x 29	70	96	4.50	\$504
G2442EL	24 x 42 x 29	70	71	3.80	\$504
G2054EL	20 x 54 x 29	85	78	5.25	\$553
G2048EL	20 x 48 x 29	70	70	4.20	\$520
G2042EL	20 x 42 x 29	70	56	3.30	\$504
G2040EL	20 x 40 x 29	70	78	4.50	\$487
G2036EL	20 x 36 x 29	70	56	3.30	\$487

Return has no pedestal. Grommet in worksurface. Shipped RTA (ready to assemble).

- For 24" deep worksurfaces, order **G24__EL**. For 20" deep worksurfaces, order **G20__EL**.

Required Specifications

Finish

Optional Specifications

Additional grommet
Key #

Accessories

Power block
Keyboard tray
Pencil tray

RETURNS

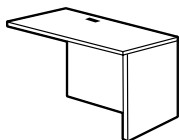

Flush Return - RIGHT

MODEL# DIMENSIONS FREIGHT CLASS WT/LBS. CUBIC FT. LIST PRICE

D x W x H

G2454ER	24 x 54 x 29	70	87	5.25	\$583
G2448ER	24 x 48 x 29	70	96	4.50	\$504
G2442ER	24 x 42 x 29	70	71	3.80	\$504
G2054ER	20 x 54 x 29	85	78	5.25	\$553
G2048ER	20 x 48 x 29	70	70	4.20	\$520
G2042ER	20 x 42 x 29	70	63	3.80	\$504
G2040ER	20 x 40 x 29	70	78	4.50	\$487
G2036ER	20 x 36 x 29	70	56	3.30	\$487

Return has no pedestal. Grommet in worksurface. Shipped RTA (ready to assemble).

- For 24" deep worksurfaces, order **G24__ER**. For 20" deep worksurfaces, order **G20__ER**.

FLUSH BRIDGE

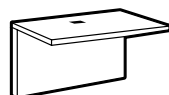

Flush Bridge

G2448FB	24 x 48 x 29	70	78	3.50	\$383
G2442FB	24 x 42 x 29	70	65	3.06	\$370
G2436FB	24 x 36 x 29	70	58	3.50	\$369
G2048FB	20 x 48 x 29	70	71	3.30	\$383
G2042FB	20 x 42 x 29	70	61	4	\$370

Top surface, back panel and hardware to connect two units. Grommet in worksurface. Shipped RTA (ready to assemble).

- **G2448/G2442** models will connect 66" and 72" units plus all D islands.
- **G2048/G2042** models will connect 60", 66" and 72" units plus all D islands and 5 sided corners.

CREDENZAS



Center Storage Credenza*

G2066C	20 x 66 x 29	100	225	27	\$1121
--------	--------------	-----	-----	----	---------------

Standard with box/file pedestals on both sides and self-closing hinged center doors covering one adjustable shelf. Right pedestal and doors lock. One pencil tray.

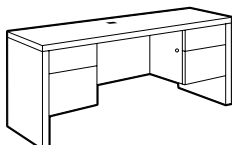

Kneespace Credenza*

G2072CK	20 x 72 x 29	125	209	29.50	\$1034
G2066CK	20 x 66 x 29	125	201	27	\$978
G2060CK	20 x 60 x 29	125	193	24.50	\$907

Standard with box/file pedestals on both sides. Center is open. Pedestals lock. One pencil tray. Grommet in worksurface.

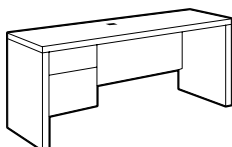

Single Pedestal Credenza - LEFT*

G2072CSL	20 x 72 x 29	150	171	29.50	\$876
G2066CSL	20 x 66 x 29	150	163	27.75	\$860
G2060CSL	20 x 60 x 29	125	155	24.50	\$757

Standard with box/file pedestal. Pedestal locks. One pencil tray. Pedestal is on the **left**. Grommet in worksurface.

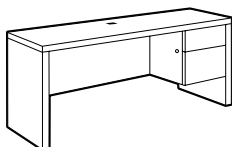

Single Pedestal Credenza - RIGHT*

G2072CSR	20 x 72 x 29	150	150	29.50	\$876
G2066CSR	20 x 66 x 29	150	150	29.40	\$860
G2060CSR	20 x 60 x 29	150	136	24.50	\$757

Standard with box/file pedestal. Pedestal locks. One pencil tray. Pedestal is on the **right**. Grommet in worksurface.

Required Specifications

Finish

Optional Specifications

Full modesty*
Grommet
Key #

Accessories

Power block
Keyboard tray
Pencil tray

5-SIDE CORNERS

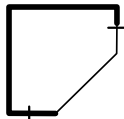
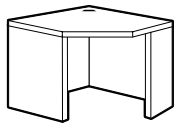

5-Sided Corner

MODEL#	DIMENSIONS D x W x H	FREIGHT CLASS	WT/LBS.	CUBIC FT.	LIST PRICE
G42205C9	42 x 42 x 29	70	123	5.75	\$787
G36205C9	36 x 36 x 29	65	105	4.30	\$668

Connects to lateral file, storage cabinet, single pedestal credenza with half end panel, and flush bridge. Grommet in worksurface. Full and narrow end panels supplied. Can be assembled left or right. Shipped RTA (ready to assemble)

- ¾ Modesty Panel is not available

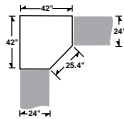
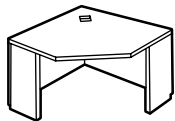

5-Sided Corner

G42245C	42 x 42 x 29	65	114	5	\$799
---------	--------------	----	-----	---	--------------

Connects to **24"** returns, bridges and other **24"** units. Grommet in worksurface. Narrow end panels on left and right. Shipped RTA (ready to assemble).

- ¾ Modesty Panel is not available

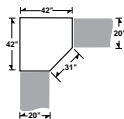
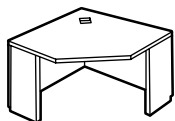

5-Sided Corner

G42205C	42 x 42 x 29	70	108	5	\$774
G36205C	36 x 36 x 29	70	92	4.75	\$685

Connects to **20"** returns, bridges and other **20"** units. Grommet in worksurface. Narrow end panels on left and right. Shipped RTA (ready to assemble).

- ¾ Modesty Panel is not available

"D" ISLANDS

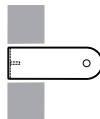
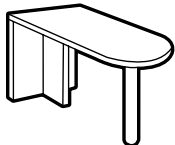

"D" Island - Full End Panel & Post

G3072FI	29.69 x 72 x 29	70	101	5	\$763
G3066FI	29.69 x 66 x 29	70	96	4.60	\$748
G3060FI	29.69 x 60 x 29	70	91	4.20	\$694

Connects to single pedestal credenza with half end panel or bridge to create a "T" grouping. **Not freestanding.** Connecting hardware for flush installation included. Shipped RTA (ready to assemble).

HUTCHES

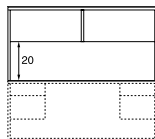
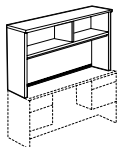

Open Hutch with Closed Back*

G72HOCB	15 x 72 x 36	70	138	7	\$876
G71HOCB	15 x 71.63 x 36	70	137	7	\$876
G69HOCB	15 x 69 x 36	70	135	7	\$876
G66HOCB	15 x 66 x 36	70	133	7	\$842
G60HOCB	15 x 60 x 36	65	123	5.25	\$757

One 1" thick fixed shelf **and fixed shelf divider**. Closed back features a flexible sweep for wire management. Available in single color only. Rectangular grommet available on back panel - **Add \$69**. Shipped RTA (ready to assemble).

- **G71HOCB** for use when spanning 30" x 60/66" SPL/R and 20/24" x 42" FL/FR/L4/R4.
- **G69HOCB** for use when spanning 30" x 60/66" SPL/R and 20" x 40" FL/FR/EL/ER.
- Clearance from worksurface to hutch doors is 20".
- Woodgrain runs horizontal on both the upper and lower back panels.

Required Specifications
Finish

Optional Specifications
Grommet

Accessories
Power Block
Keyboard Tray
Pencil Tray
Doors*

HUTCHES

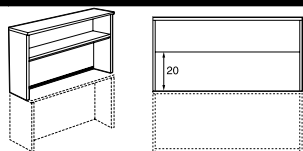

Open Hutch with Closed Back*

MODEL# DIMENSIONS FREIGHT CLASS WT/LBS. CUBIC FT. LIST PRICE

	D x W x H				
G48HOCB	15 x 48 x 36	65	100	4.20	\$606
G42HOCB	15 x 42 x 36	65	91	3.80	\$606
G40HOCB	15 x 40 x 36	65	88	3.80	\$606
G36HOCB	15 x 36 x 36	65	82	3.30	\$534

One 1" thick fixed shelf. Closed back features a flexible sweep for wire management. Available in single color only. Rectangular grommet available on back panel - **Add \$69**. Shipped RTA (ready to assemble).

- Clearance from work surface to hutch doors is 20".
- Woodgrain runs horizontal on both the upper and lower back panels.

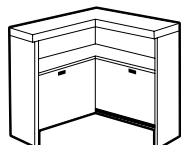

Corner Hutch with Closed Back*

G4242CH	15 x 42 x 36	70	137	6.25	\$964
G3636CH	15 x 36 x 36	65	119	4.80	\$876

One 1" thick fixed shelf. Closed back features a flexible sweep for wire management on lower right panel. Available in single color only. Rectangular grommet available on back panel - **Add \$69**. Shipped RTA (ready to assemble).

- Woodgrain runs horizontal on both the upper and lower back panels.

PIGEON HOLE STORAGE

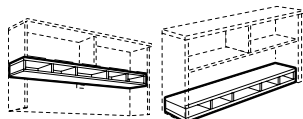

Horizontal Pigeon-Hole Storage

AHS72	11.25 x 70 x 5.62	85	41	3	\$524
AHS71	11.25 x 71 x 5.62	70	43.50	2.30	\$524
AHS66	11.25 x 64 x 5.62	85	38	2.80	\$524
AHS60	11.25 x 58 x 5.62	85	35	2.50	\$429
AHS48	11.25 x 46 x 5.62	85	28	2	\$316
AHS42	11.25 x 40 x 5.62	85	24	2	\$316
AHS36	11.25 x 34 x 5.62	92.5	22	2	\$258

For additional storage. Can be **top** or **bottom** mounted. For use inside **straight hutch** (end panels not finished). Shipped RTA (ready to assemble). **Black finish only.**

- Cannot be used on A00S and C00S Overstorage Units.

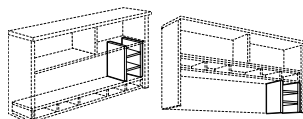

Vertical Pigeon-Hole Storage

AVS14	11.25 x 13.37 x 14.37	85	13	.90	\$327
-------	-----------------------	----	----	-----	--------------

For use in conjunction with the Horizontal Pigeon-Hole Storage. Can be used **under** or **over** horizontal unit. Shipped RTA (ready to assemble). **Black finish only.**

HUTCH DOORS

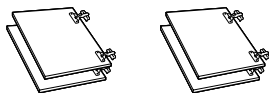

Four-Door Kit

GDOOR72	.69 x 72 x 15	85	24	1.75	\$322
GDOOR71	15.68 x 0 x 15	85	24	1.75	\$322
GDOOR69	15.68 x 0 x 15	85	23	1.75	\$322
GDOOR66	.69 x 66 x 15	85	22	1.75	\$322
GDOOR60	.69 x 60 x 15	92.5	20	1.75	\$322

For use on 72", 71", 69", 66" and 60"W straight hutches. Hinges included. Locks available, Add **\$101** each lock. Doors for units 60" wide or more require two locks.

Required Specifications

Finish

Accessories

Doors*

HUTCH DOORS

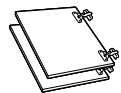

Two-Door Kit

MODEL#	DIMENSIONS D x W x H	FREIGHT CLASS	WT/LBS.	CUBIC FT.	LIST PRICE
GDOOR48	.69 x 48 x 15	100	17	1.75	\$201
GDOOR42	.69 x 42 x 15	100	16	1.75	\$201
GDOOR40	.69 x 40 x 15	100	15	1.75	\$201
GDOOR36	.69 x 36 x 15	100	14	1.75	\$201

For use on 48", 42" 40" and 36"W straight hutches. Hinges included. Locks available, Add **\$101** each lock. Doors for units 48" wide or less require one lock.

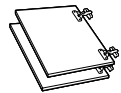

Corner Hutch Two-Door Kit

GDOOR42C	15.68 x 0 x 15	92.5	19	1.75	\$345
GDOOR36C	15.68 x 0 x 15	100	16	1.75	\$224

For use on 42" and 36"W corner hutches. Hinges included. **Locks not available on corner hutch doors.**

TACKBOARDS FOR HUTCHES

TACKBOARD Notes: Tackboards can be upholstered in all of the following fabrics:

Grade 1: Agate II, Hudson, Jenny, Quilt, Terrace, Urban, Waterfall

Grade 2: Couture, Crescent, Imprint, Lola, Match, Renewal, Replay, Silhouette

Grade 3: Anchorage, Brinx, Mariposa, Merge

Grade 4: Accent

Grade 5: Meander, Tracery, Universe

FABRIC GRADE LIST PRICE

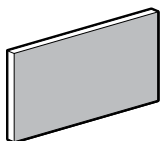

Tackboard

TB7018	1 x 70 x 18	92.5	12	1.10	1	\$391
					2	\$450
					3	\$497
					4	\$569
					5	\$654

For use on **G72HOCB** straight hutch. Includes mounting screws and covers.

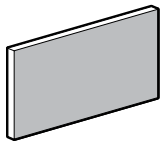

Tackboard

TB6918	1 x 69.5 x 18	92.5	12	1.05	1	\$391
					2	\$450
					3	\$497
					4	\$569
					5	\$654

For use on **G71HOCB** straight hutch. Includes mounting screws and covers.

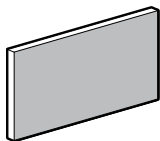

Tackboard

TB6718	1 x 67.5 x 18	92.5	12	1.05	1	\$391
					2	\$450
					3	\$497
					4	\$569
					5	\$654

For use on **G69HOCB** straight hutch. Includes mounting screws and covers.

Required Specifications

Fabric (Tackboards)

TACKBOARDS

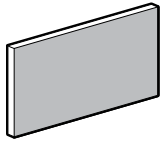

Tackboard

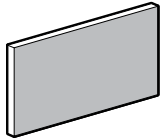

Tackboard

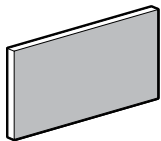

Tackboard

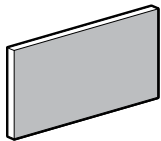

Tackboard

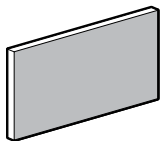

Tackboard

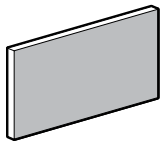

Tackboard

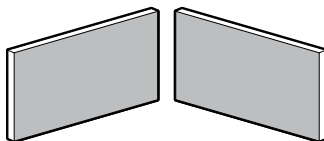

Tackboard

MODEL#	DIMENSIONS	FREIGHT CLASS	WT/LBS.	CUBIC FT.	FABRIC GRADE	LIST PRICE
--------	------------	---------------	---------	-----------	--------------	------------

D x W x H

TB6418	1 x 64 x 18	92.5	11	1	1	\$351
					2	\$403
					3	\$446
					4	\$511
					5	\$589

For use on **G66HOCB** straight hutch. Includes mounting screws and covers.

TB5818	1 x 58 x 18	92.5	10	.90	1	\$325
					2	\$372
					3	\$412
					4	\$468
					5	\$539

For use on **G60HOCB** straight hutch. Includes mounting screws and covers.

TB4618	1 x 46 x 18	92.5	9	.80	1	\$223
					2	\$263
					3	\$296
					4	\$342
					5	\$394

For use on **G48HOCB** straight hutch. Includes mounting screws and covers.

TB4018	1 x 40 x 18	92.5	8	.70	1	\$217
					2	\$251
					3	\$279
					4	\$320
					5	\$368

For use on **G42HOCB** straight hutch. Includes mounting screws and covers.

TB3818	1 x 38 x 18	92.5	7	.70	1	\$217
					2	\$250
					3	\$277
					4	\$317
					5	\$364

For use on **G40HOCB** straight hutch. Includes mounting screws and covers.

TB3418	1 x 34 x 18	92.5	6	.60	1	\$209
					2	\$240
					3	\$267
					4	\$306
					5	\$353

For use on **G36HOCB** straight hutch. Includes mounting screws and covers.

TB42CH	1 x 39-40 x 15	70	16	.85	1	\$391
					2	\$428
					3	\$463
					4	\$511
					5	\$589

For use on **G4242CH** corner hutch. Includes mounting screws and covers.

Required Specifications

Fabric

TACKBOARDS

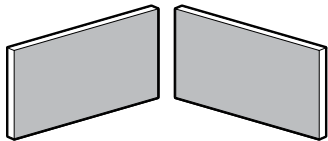

Tackboard

MODEL#	DIMENSIONS D x W x H	FREIGHT CLASS	WT./LBS.	CUBIC FT.	FABRIC GRADE	LIST PRICE
TB36CH	1 x 34 x 15	85	12	.85	1	\$375
					2	\$411
					3	\$439
					4	\$492
					5	\$567

For use on **G3636CH** corner hutch. Includes mounting screws and covers.

ACCESSORY PIECES

LIST PRICE

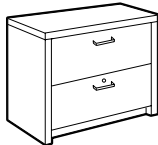

2 Drawer Lateral File*

G2036LF	20 x 36 x 29	100	145	15		\$876
---------	--------------	-----	-----	----	--	--------------

Two full suspension drawers. Front-to-back and side-to-side letter/legal filing capability with lock. Anti-lock tilt suspension.

- To comply with ANSI/BIFMA stability tests, the Lateral File Counter Weight Kit (model "LFCWKIT36") MUST be used.
- *Back of file is always Black.*
- *File drawer construction is for accommodating hanging files NOT for stacking materials on the drawer bottom.*

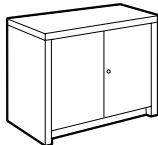

Storage Cabinet*

G2036SC	20 x 36 x 29	100	121	15		\$623
---------	--------------	-----	-----	----	--	--------------

Hinged doors cover one adjustable shelf. Standard with lock.

- *Back of storage cabinet is always Black.*

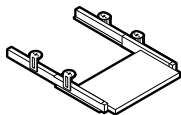

Pull-Out Keyboard

GPOKL28	11 x 28 x 3.5	85	13	.90		\$224
GPOKL22	11 x 22 x 3.5	85	11	.90		\$212

Constructed of thermofused laminate.

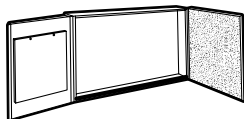

Visual Board

GVB4848	4 x 48 x 48	85	122	9.25		\$1274
---------	-------------	----	-----	------	--	---------------

Includes white board and two side opening doors containing cork board on right door and 50-sheet paper writing pad on left door. Marker board can be used for projection. Set of 4 dry markers and eraser included.

- **NOTE:** *Care should be taken to mount the units. Units should be mounted to wall studs using correct fasteners. Failure to do so may result in collapse of the unit and subsequent personal injury. **Mounting hardware not included.** Mounting hardware used should be based on wall material. Consult an installation professional for proper wall mounting.*

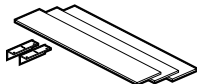

Counter Weight Kit

LFCWKIT36	6 x 33 x 1	60	40	.25		\$566
-----------	------------	----	----	-----	--	--------------

3 metal plates. Plates mount to the underside of any 36" wide Lateral File or Mixed Storage/Drawer cabinet. Includes mounting hardware. Must be ordered separately. Field installed.

- To comply with ANSI/BIFMA stability tests, the Lateral File Counter Weight Kit MUST be used with the appropriate Lateral Files and Mixed Storage Cabinets.

Required Specifications

Fabric (tackboards)
Finish (accessories)

Optional Specifications

Key #*
Grommet (only G2036LF)

BOOKCASES

MODEL# DIMENSIONS FREIGHT CLASS WT/LBS. CUBIC FT. LIST PRICE

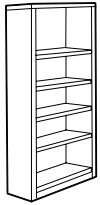

Bookcase - 84" High

D x W x H					
GHBC84	12 x 36 x 84	125	198	26	\$1102

One fixed heavy duty shelf and **four adjustable shelves**. Shipped fully assembled.

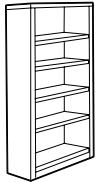

Bookcase - 72" High

GHBC72	12 x 36 x 72	100	173	20	\$919
--------	--------------	-----	-----	----	--------------

One fixed heavy duty shelf and **four adjustable shelves**. Shipped fully assembled.

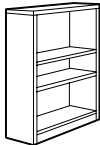

Bookcase - 48½" High

GHBC48	12 x 36 x 48	100	118	13.70	\$674
--------	--------------	-----	-----	-------	--------------

Two adjustable heavy duty shelves. Shipped fully assembled.

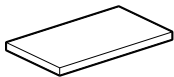

Bookcase Shelf

GHBCSHELF	12 x 34 x 1	100	13	1.60	\$171
-----------	-------------	-----	----	------	--------------

Extra shelf for bookcases. 1" thick.

Required Specifications

Finish (bookcases)



Halton was designed with both value and design in mind. A substantial edge treatment and hundreds of color combinations make Halton a series that will add flair to any office setting while still meeting budget requirements.

Halton's array of desks, returns and credenzas coordinate with any office decor and integrate easily with Global filing, storage, accessories and hutches. Whether you need a simple or a more complex office layout design, Halton can easily accommodate your workspace.

All desks, returns and credenzas offer ¾ or full to the floor pedestals. Choose from many solid and woodgrain laminate finishes to create unique, mix-and-match combinations or classic tone on tone finishes. For a great look at an even better price, Halton is an ideal choice.



Features and Benefits

- 45lb. density particle board substructure with high performance thermally fused laminate
- Available bow front desk provides extra legroom and work area for visitors
- ¾ modesty panel is standard; full modesty available
- Pencil tray included in box drawer
- Box drawers mounted on ¾ extension steel ball bearings
- All drawers feature French dovetail joint in front and lapjoint in back
- Drawers open with side pull
- Compatible with **Divide** panel system for increased privacy and storage requirements

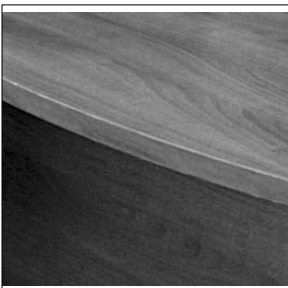

Bow front available on 36"x 72" desks



3mm edge top over side panel design

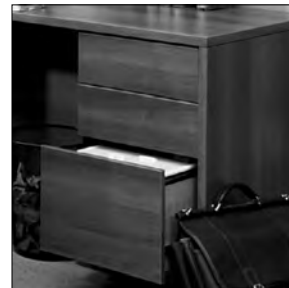

Full to floor pedestals available on all models

GENERAL INFORMATION

- Halton components are compatible with **Divide** partitioning panels.
- 3mm edge on all surfaces as well as drawer fronts
- Panel end style with top over side panel design
- Genoa desk and storage products have been tested and comply with all BIFMA mechanical tests.
- GREENGUARD INDOOR AIR QUALITY CERTIFICATION - Global laminate and seating products are in compliance with stringent emission guidelines set out by the Greenguard Environmental Institute under the standards for low emitting products and materials. www.greenguard.org.
- **Level 3 Certified**

CONSTRUCTION

- Constructed of 45 lb. density particle board with high performance thermally fused laminate.
- All surfaces feature 3mm plastic edging in matching finish on all sides.
- Panel end style with top over side panel design
- Full to the floor pedestal configurations can be switched for a **15% upcharge**

MODESTY PANELS

- Recessed ¾ height modesty panel is standard. Full modesty panel is available. **Add \$55.**
- All full to floor units, bridges and returns are standard with a full modesty panel

LOCKS

- Standard on all box and file pedestals; file drawer and lower box drawer only lock.

FINISHES

ACJ	Absolute Acajou
ASN	Asian Night
AWC	Avant Cherry
AWH	Avant Honey
BLK	Black
BRC	Brushed Cobalt
CMB	Clear Maple
DES	Dark Espresso
DWT	Designer White
HGT	Hayden Grey
QTM	Quartered Mahogany
SOG	Storm Grey
TFW	Tiger Fruitwood
TWL	Tiger Walnut
WHE	Walnut Heights
WHC	White Chocolate
WGY	Willow Grey
WCR	Winter Cherry

GROMMETS

- Additional grommets available in standard worksurface locations (left, center or right). Order as: **AG1, AG2 or AG3. Add \$69**
- Grommet hole dimensions are 3 ¼" wide x 1 7/8" deep.

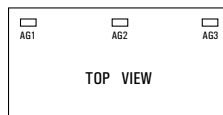

- Actual grommet locations on the worksurface are depicted in the example drawings shown below. Dimensions shown are actual measurements (in inches).

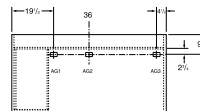

36 x 72 single pedestal left desks (3672SPL)

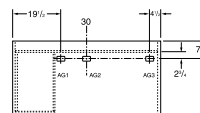

30 x 60 single pedestal left desks (3060SPL)

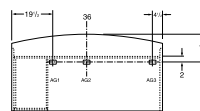

36 x 72 single pedestal left bow top desks (3672SLB)

- Grommets may be placed at non-standard locations. Order as: **AGS - Add \$69.** A drawing must be supplied with vertical and horizontal dimensions to the center of the cut-out (as in drawing above). Please refer to CUSTOM GROMMET LOCATION FORM in the back reference section.
- Components that come standard with grommet may be ordered without a grommet. **Add \$37.**

POWER BLOCK

- A Power Block (model **PMSPDM**) may be ordered on all worksurfaces.
- A Power Block is a rectangular worksurface power/data module with one electrical duplex receptacle and two data (RJ45) receptacles. 9 foot black cord included. Power Block dimensions are 3 ½" deep x 6 ½" wide x 2 ¾" high.
- To purchase a Power Block, you must specify both the Power Block cut-out location and the Power Block model #. Order Power Block as **PMSPDM, Add \$261.** Power Blocks are available in standard worksurface locations (left, center or right). Order as **E1, E2 or E3. Add \$69.**

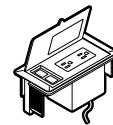

Power Block **PMSPDM Add \$261**

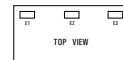

Specify location **E1, E2 or E3 Add \$69**

DOUBLE PEDESTAL DESKS

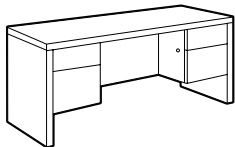

Double Pedestal Desk

MODEL#	DIMENSIONS D x W x H	FREIGHT CLASS	WT./LBS.	CUBIC FT.	LIST PRICE
H3672DP	36 x 72 x 29	150	260	52.50	\$1152
H3072DP	30 x 72 x 29	150	229	43.75	\$1104
H3066DP	29.69 x 66 x 29	150	223	39.75	\$1073
H3060DP	29.69 x 60 x 29	125	218	36.25	\$964

Standard with box/file pedestals on both sides. Pedestals lock. One pencil tray.

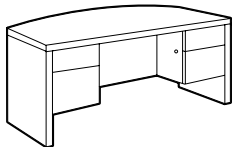

Double Pedestal Bow Top Desk

H3672DPB	30-36 x 72 x 29	150	258	52	\$1344
----------	-----------------	-----	-----	----	---------------

Standard with box/file pedestals on both sides and bow top. Pedestals lock. One pencil tray.

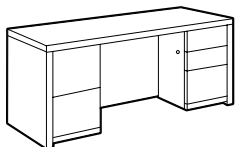

Full to Floor Double Pedestal Desk

H3672D4	36 x 72 x 29	150	306	52	\$1483
H3072D4	30 x 72 x 29	125	288	43.75	\$1444
H3066D4	29.69 x 60 x 29	125	271	39.75	\$1406
H3060D4	29.69 x 60 x 29	125	254	36.25	\$1293

Standard with box/box/file in right pedestal and file/file in left pedestal. Pedestals lock. One pencil tray. Full to the floor pedestal configurations can be switched for a **15% upcharge**.

- On full to the floor box/box/file pedestals, lower box drawer and file drawer lock.

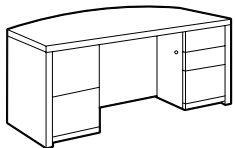

Full to Floor Double Pedestal Bow Top Desk

H3672DB4	30-36 x 72 x 29	150	288	52	\$1675
----------	-----------------	-----	-----	----	---------------

Standard with box/box/file in right pedestal and file/file in left pedestal. Bow top. Pedestals lock. One pencil tray. Full to the floor pedestal configurations can be switched for a **15% upcharge**.

- On full to the floor box/box/file pedestals, lower box drawer and file drawer lock.

SINGLE PEDESTAL DESKS

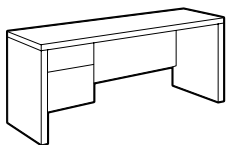

Single Pedestal Desk - LEFT

H3672SPL	36 x 72 x 29	150	218	52	\$1010
H3072SPL	30 x 72 x 29	150	192	43.75	\$959
H3066SPL	29.69 x 66 x 29	150	182	39.75	\$901
H3060SPL	29.69 x 60 x 29	150	174	36.25	\$828
H3048SPL	29.69 x 48 x 29	150	157	29.50	\$803
H2448SPL	24 x 48 x 29	150	140	24.25	\$803
H2445SPL	24 x 45 x 29	150	132	22.50	\$668

Standard with box/file pedestal. Pedestal locks. One pencil tray. Pedestal is on the **left**.

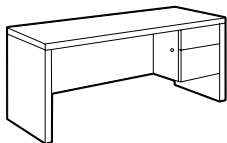

Single Pedestal Desk - RIGHT

H3672SPR	36 x 72 x 29	150	218	52	\$1010
H3072SPR	30 x 72 x 29	150	192	43.75	\$959
H3066SPR	29.69 x 66 x 29	150	182	39.75	\$901
H3060SPR	29.69 x 60 x 29	150	174	36.25	\$828
H3048SPR	29.69 x 48 x 29	150	157	29.50	\$803
H2448SPR	24 x 48 x 29	125	168	24.25	\$803
H2445SPR	24 x 45 x 29	150	132	22.50	\$668

Standard with box/file pedestal. Pedestal locks. One pencil tray. Pedestal is on the **right**.

Required Specifications

Top finish
Base finish

Optional Specifications

Additional grommet
Key #

Accessories

Power block
Keyboard tray
Pencil tray

SINGLE PEDESTAL DESKS

MODEL# DIMENSIONS FREIGHT CLASS WT/LBS. CUBIC FT. LIST PRICE

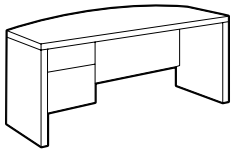

Single Pedestal Bow Top Desk - LEFT

D x W x H
 H3672SLB 30-36 x 72 x 29 150 218 52 **\$1209**

Standard with box/file pedestal on **left** and bow top. Pedestal locks. One pencil tray.

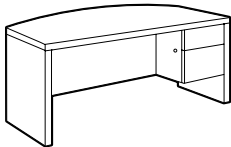

Single Pedestal Bow Top Desk - RIGHT

H3672SRB 36-36 x 72 x 29 150 218 52 **\$1209**

Standard with box/file pedestal on **right** and bow top. Pedestal locks. One pencil tray.

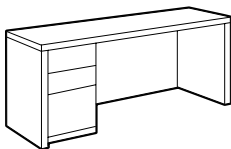

Full to Floor Single Pedestal Desk - LEFT

H3672S4L	36 x 72 x 29	150	247	52	\$1174
H3072S4L	30 x 72 x 29	150	218	43.75	\$1115
H3066S4L	29.69 x 66 x 29	150	209	39.75	\$1066
H3060S4L	29.69 x 60 x 29	150	200	36.25	\$993
H3048S4L	29.69 x 48 x 29	125	181	29.50	\$970
H2448S4L	24 x 48 x 29	125	168	24.25	\$970

Standard with full to floor box/box/file pedestal on the **left**. One pencil tray. Lower box drawer and file drawer lock. Full to the floor pedestal configurations can be switched for a **15% upcharge**.

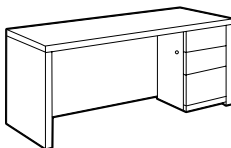

Full to Floor Single Pedestal Desk - RIGHT

H3672S4R	36 x 72 x 29	150	247	52	\$1174
H3072S4R	30 x 72 x 29	150	218	43.75	\$1115
H3066S4R	29.69 x 66 x 29	150	209	39.75	\$1066
H3060S4R	29.69 x 60 x 29	150	200	36.25	\$993
H3048S4R	29.69 x 48 x 29	125	181	29.50	\$970
H2448S4R	24 x 48 x 29	125	168	24.25	\$970

Standard with full to floor box/box/file pedestal on the **right**. One pencil tray. Lower box drawer and file drawer lock. Full to the floor pedestal configurations can be switched for a **15% upcharge**.

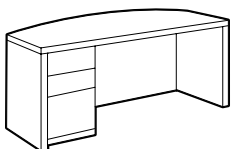

Full to Floor Single Pedestal Bow Top Desk - LEFT

H3672S4LB 30-36 x 72 x 29 150 234 52 **\$1372**

Standard with box/file pedestal on **left** and bow top. One pencil tray. Lower box drawer and file drawer lock. Full to the floor pedestal configurations can be switched for a **15% upcharge**.

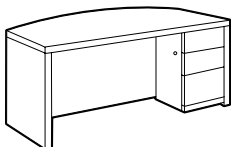

Full to Floor Single Pedestal Bow Top Desk - RIGHT

H3672S4RB 30-36 x 72 x 29 150 234 52 **\$1372**

Standard with box/file pedestal on **right** and bow top. One pencil tray. Lower box drawer and file drawer lock. Full to the floor pedestal configurations can be switched for a **15% upcharge**.

Required Specifications

Top finish
 Base finish

Optional Specifications

Additional grommet
 Key #

Accessories

Power block
 Keyboard tray
 Pencil tray

RETURNS

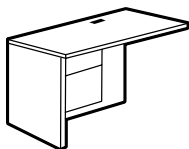

Flush Return - LEFT

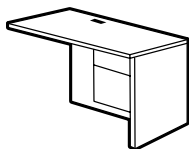

Flush Return - RIGHT

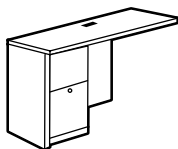

Full to Floor Flush Return - LEFT

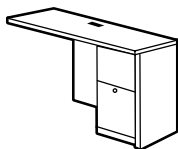

Full to Floor Flush Return - RIGHT

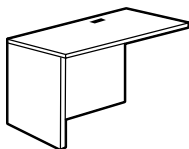

Flush Return - LEFT*

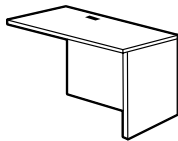

Flush Return - RIGHT*

MODEL#	DIMENSIONS	FREIGHT CLASS	WT/LBS.	CUBIC FT.	LIST PRICE
--------	------------	---------------	---------	-----------	------------

D x W x H

H2448FL	24 x 48 x 29	150	133	24.25	\$685
H2442FL	24 x 42 x 29	150	123	21.25	\$678
H2042FL	20 x 42 x 29	150	104	18	\$662

Standard with box/file drawer pedestal. Pedestal locks. Grommet in worksurface. Pedestal is on the **left**.

H2448FR	24 x 48 x 29	150	133	24.25	\$685
H2442FR	24 x 42 x 29	150	123	21.25	\$678
H2042FR	20 x 42 x 29	150	104	18	\$662

Standard with box/file drawer pedestal. Pedestal locks. Grommet in worksurface. Pedestal is on the **right**.

H2448L4	24 x 48 x 29	125	148	24.25	\$852
H2442L4	24 x 42 x 29	125	139	21.25	\$842
H2042L4	20 x 42 x 29	125	120	18	\$828

Standard with file/file drawer pedestal. Pedestal locks. Grommet in worksurface. Pedestal is on the **left**.

H2448R4	24 x 48 x 29	125	148	24.25	\$852
H2442R4	24 x 42 x 29	125	139	21.25	\$842
H2042R4	20 x 42 x 29	125	120	18	\$828

Standard with file/file drawer pedestal. Pedestal locks. Grommet in worksurface. Pedestal is on the **right**.

H2448EL	24 x 48 x 29	70	90	4.30	\$473
H2442EL	24 x 42 x 29	70	81	3.80	\$473
H2042EL	20 x 42 x 29	85	53	3.80	\$456

Return has no pedestal. Grommet in worksurface. Shipped RTA (ready to assemble).

H2448ER	24 x 48 x 29	70	90	4.30	\$473
H2442ER	24 x 42 x 29	70	81	3.80	\$473
H2042ER	20 x 42 x 29	85	53	3.80	\$456

Return has no pedestal. Grommet in worksurface. Shipped RTA (ready to assemble).

Required Specifications

Top finish
Base finish

Optional Specifications

Additional grommet
Key #

Accessories

Power block
Keyboard tray*
Pencil tray*

FLUSH BRIDGE

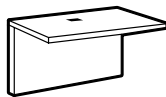

Flush Bridge

MODEL# DIMENSIONS FREIGHT CLASS WT./LBS. CUBIC FT. LIST PRICE

D x W x H

H2448FB	24 x 48 x 29	70	74	4.30	\$434
H2442FB	24 x 42 x 29	70	65	3.80	\$424
H2048FB	20 x 48 x 29	70	69	4.30	\$434
H2042FB	20 x 42 x 29	70	61	3.80	\$424

Top surface, back panel and hardware to connect two units. Grommet in worksurface. Shipped RTA (ready to assemble).

- **H2448/H2442** models will connect 66" and 72" units plus all D islands.
- **H2048/H2042** models will connect 60", 66" and 72" units plus all D islands and 5 sided corners.

CREDENZAS

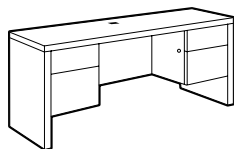

Kneespace Credenza

H2472CK	24 x 72 x 29	150	208	35.75	\$1144
H2466CK	24 x 66 x 29	125	200	32.75	\$1057
H2072CK	20 x 72 x 29	125	187	30.25	\$1121
H2066CK	20 x 66 x 29	125	180	27.75	\$1048
H2060CK	20 x 60 x 29	125	176	25.25	\$940

Standard with box/file pedestals on both sides. Center is open. Pedestals lock. One pencil tray. Grommet in worksurface.

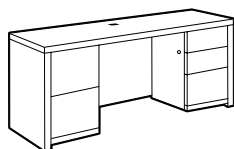

Full to Floor Kneespace Credenza

H2472D4	24 x 72 x 29	125	248	35.75	\$1476
H2466D4	24 x 66 x 29	125	240	32.75	\$1390
H2072D4	20 x 72 x 29	125	224	30.25	\$1453
H2066D4	20 x 66 x 29	125	216	27.75	\$1372
H2060D4	20 x 60 x 29	100	208	25.25	\$1269

Standard with full to floor box/box/file in right pedestal and file/file in left pedestal. Pedestals lock. One pencil tray. Full to the floor pedestal configurations can be switched for a **15% upcharge**.

- On full to the floor box/box/file pedestals, lower box drawer and file drawer lock.

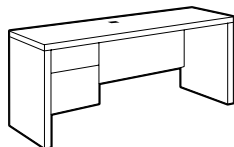

Single Pedestal Credenza - LEFT

H2472CSL	24 x 72 x 29	150	168	35.75	\$1003
H2466CSL	24 x 66 x 29	150	160	32.75	\$922
H2072CSL	20 x 72 x 29	150	149	30.25	\$985
H2066CSL	20 x 66 x 29	150	142	27.75	\$907
H2060CSL	20 x 60 x 29	150	135	25.25	\$797

Standard with box/file pedestal. Pedestal locks. One pencil tray. Pedestal is on the **left**. Grommet in worksurface.

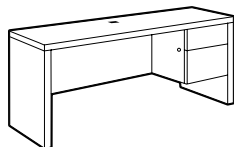

Single Pedestal Credenza - RIGHT

H2472CSR	24 x 72 x 29	150	168	35.75	\$1003
H2466CSR	24 x 66 x 29	150	160	32.75	\$922
H2072CSR	20 x 72 x 29	150	149	30.25	\$985
H2066CSR	20 x 66 x 29	150	142	27.75	\$907
H2060CSR	20 x 60 x 29	150	135	25.25	\$797

Standard with box/file pedestal. Pedestal locks. One pencil tray. Pedestal is on the **right**. Grommet in worksurface.

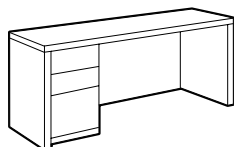

Full to Floor Single Pedestal Credenza - LEFT

H2472S4L	24 x 72 x 29	150	195	35.75	\$1167
H2466S4L	24 x 66 x 29	150	187	32.75	\$1089
H2072S4L	20 x 72 x 29	150	175	30.25	\$1152
H2066S4L	20 x 66 x 29	125	168	27.75	\$1073
H2060S4L	20 x 60 x 29	125	160	25.25	\$964

Standard with full to floor box/box/file pedestal on the **left**. One pencil tray. Lower box drawer and file drawer lock. Grommet in worksurface.

Required Specifications

Top finish
Base finish

Optional Specifications

Additional grommet
Key #

Accessories

Power block
Keyboard tray
Pencil tray

CREDENZAS

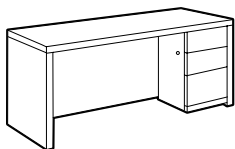

Full to Floor Single Pedestal Credenza - RIGHT**

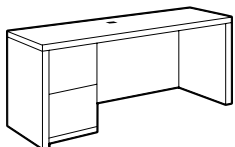

Full to Floor Single Pedestal Credenza - LEFT*

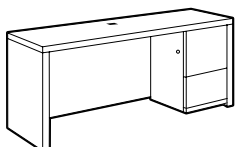

Full to Floor Single Pedestal Credenza - RIGHT*

MODEL#	DIMENSIONS	FREIGHT CLASS	WT/LBS.	CUBIC FT.	LIST PRICE
--------	------------	---------------	---------	-----------	------------

D x W x H

H2472S4R	24 x 72 x 29	150	196	35.75	\$1167
H2466S4R	24 x 66 x 29	150	187	32.75	\$1089
H2072S4R	20 x 72 x 29	150	175	30.25	\$1152
H2066S4R	20 x 66 x 29	125	168	27.75	\$1073
H2060S4R	20 x 60 x 29	125	160	25.25	\$959

Standard with full to floor box/box/file pedestal on the **right**. One pencil tray. Lower box drawer and file drawer lock. Grommet in worksurface.

H2472S2L	24 x 72 x 29	150	196	35.75	\$1167
H2466S2L	24 x 66 x 29	150	187	32.75	\$1089
H2072S2L	20 x 72 x 29	150	175	30	\$1152
H2066S2L	20 x 66 x 29	125	168	27.75	\$1073
H2060S2L	20 x 60 x 29	125	160	25.25	\$964

Standard with full to floor file/file pedestal on the **left**. Pedestal locks. Grommet in worksurface.

H2472S2R	24 x 72 x 29	150	196	35.75	\$1167
H2466S2R	24 x 66 x 29	150	187	32.75	\$1089
H2072S2R	20 x 72 x 29	150	175	30	\$1152
H2066S2R	20 x 66 x 29	125	168	27.75	\$1073
H2060S2R	20 x 60 x 29	125	160	25.25	\$964

Standard with full to floor file/file pedestal on the **right**. Pedestal locks. Grommet in worksurface.

ACCESSORIES

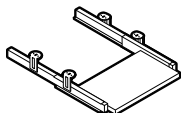

Pull-Out Keyboard

APOKL28	17 x 28 x 3.5	85	13	.90	\$253
APOKL22	17 x 22 x 3.5	85	12	.90	\$228

Constructed of thermofused laminate.

Required Specifications

Top finish
Base finish

Optional Specifications

Additional grommet*
Key #*

Accessories

Power block*
Keyboard tray**
Pencil tray**



The design of Princeton reflects the personality of today's young, dynamic workforce. The freestanding, modular components build out from you and where you work. With over 1000 available components, Princeton offers a flexible footprint that's simple to reconfigure. A variety of storage options allows you to do more with less space.

Princeton delivers contemporary design to the workplace; whether it be in Commercial and Corporate offices, Government offices, Small Businesses, Banking, Legal, Accounting, Hospitality or the professional home office. Every element, from the mix of materials and finishes to open storage pieces, floating modesties and overlapping surfaces, has been designed to provide visual appeal and intelligent function. Princeton is a freestanding and fully modular collection offering maximum flexibility; ease of installation and facilitates simple reconfigurations. The overlapping worksurface design also allows the footprint to adapt to smaller spaces by just a few inches.



Features and Benefits

- 1" thick worksurfaces in thermally fused or high pressure laminate
- Worksurfaces feature Global's preferred edging in matching color
- Counterweights standard on all mobile pedestals, lateral files and credenzas
- Handles & pulls in satin anodized finish standard on all credenza, pedestal drawers and cabinet doors
- Monoposts and hutch supports standard in tungsten finish
- Benches double as lateral filing
- Pull-out equipment shelves on select credenzas
- Energy efficient LED lighting for overhead storage cabinets
- Grommets and power blocks to accommodate power/data needs
- Choose glass or fabric equipment screens



Bench doubles as lateral filing



Pull out equipment shelf (printer not included)



Bookshelf with accessory hook

GENERAL INFORMATION

- Over 500 components are available
- No cubicles or panels needed for configurations
- Product can be added and reconfigured as needed
- Princeton desk and storage products have been tested and comply with all BIFMA mechanical tests.
- Global laminate and seating products are in compliance with stringent emission guidelines set out by the Greenguard Environmental Institute under the standards for low emitting products and materials. www.greenguard.org
- **Level 3 Certified**

WORKSURFACES

- 1" thick high performance thermally fused laminate tops sealed with Global's preferred edge detail in matching color
- High Pressure Tops are available in all Princeton laminate finishes at an extended lead time. Please see model # for pricing and availability
- Products specified with the high pressure laminate option are finished on the underside of the surface with a kraft paper backing.
- Worksurfaces with metal legs which have a span of 54" and over are standard with metal support channel. Support channels come in Black (BLK) only.
24"D and 30"D - 1 - 2"H support channel
36"D - 2 - 2"H support channels

CONSTRUCTION

- Laminate end panel and metal leg products are **not intended** to be combined for the most visually compatible design. They are, however, interchangeable if required.
- All components have Global's preferred matching edge
- Leveling glides are standard on all floor units.
- End panels are 1.5" thick on laminate end panel desks and credenzas. Cabinet end panels are 11/16" thick.
- 1" x 2" metal frame legs finished in Tungsten (**TUN**), Black (**BLK**) or Designer White (**DWT**) for desks and returns (closed 'O' style leg)
- 1" x 2.5" metal frame legs finished in Tungsten (**TUN**), Black (**BLK**) or Designer White (**DWT**) for freestanding tables (open 'U' style leg)
- Constructed of 45 lb. density particleboard with high performance thermally fused laminate.
- Mobile pedestals and mobile lateral files come standard with front locking casters
- Counterweights are standard on all pedestals, lateral files, credenzas and cabinets
- Rolling table come standard with non-locking casters
- Laminate shelves are 11/16" thick and edged on all 4 sides.
- Tempered glass is 6mm thick with satin-etched finish on one side.
- Credenzas come standard with file bars for side-to-side and front-to-back letter and legal filing capability.
- Handles and pulls in satin anodized finish are standard on all credenza, pedestal drawers and cabinet doors.
- Pull-out equipment shelves are available on select credenzas.
- Grommets and power blocks are available to accommodate power/data needs.

EDGE DETAILS

- All worksurfaces and components have Global's preferred matching edge detail on all sides
- Edging cannot be specified separately. No substitutions.

LAMINATE MODESTY PANELS

- Standard on all desks with laminate end panels, returns with laminate end panels and bridges for laminate end panel desks.
- Flush on Freestanding Returns with laminate end panels
- Recessed 4"D on 24"D desks with laminate end panels, 5"D on 30"D desks with laminate end panels and 6"D on 36"D desks with laminate end panels.

- Recessed 4"D on 24"D, 5"D on 30"D, and 6"D on 36"D flush and overlapping returns with laminate end panels.
- Recessed 4" on 24"D and 5"D on 30"D flush and overlapping bridges with laminate end panels.
- Desks and returns feature modesty panel that is flush with end panel
- Bottom of laminate modesty panel is 17 3/4" from floor.

GLASS DESKTOP PANELS

- Glass desktop panel is sold separately. See selection on page 83.
- Available for installation onto desks, returns, bridges and conference tops
- Made of 6mm tempered glass with satin-etched finish on one side
- On-site installation is required. Installation instructions will be provided.

FABRIC AND DESKTOP PANELS

- Fabric desktop and fabric modesty panels are sold separately. See selection on page 83.
- Available in:
Grade 1: Agate II, Jenny, Quilt
Grade 2: Blink, Brinx, Lola, Mariposa, Quadrille, Quantum, Replay, Silhouette
Grade 3: Abstract, Accent, Anchorage, Identity, Merge, Stitch
Grade 5: Momentum: Universe
- On-site installation is required for fabric desktop and fabric modesty panels. Installation instructions will be provided.
- Non-tackable
- Bottom of fabric modesty panel is 15.5" from floor

STORAGE

- Mobile storage greater than 25.5"H may only be used with 29"H Princeton products with laminate end panels or gables. Princeton products with **metal legs** will not accommodate anything higher than 25.5".
- Roll-out shelf on credenza holds up to 80 lbs
- All cabinets with side open shelf area that aligns with 29"H or 27"H credenzas - fixed shelf is 1" thick
- Recycling/waste drawer accommodates 1 recycling basket and 1 waste basket

CREDENZAS

- Available in 29", 27" and 23" heights
- 29"H connect to flush returns, flush conference tops and flush bridges
- 27"H connect to overlapping returns, overlapping conference tops and overlapping bridges
- Fixed drawer widths - see individual models for details
- Upper adjustable shelf must be removed when products with laminate modesty panels are installed (i.e. PN2448RFR flush return with laminate end panel or PN2436BF flush bridge for laminate end panel desk)
- Connection of flush or overlapping surfaces to credenzas is only possible over full height opening
- All credenza tops are 1" thick
- Grommet location is 2.5" from the back edge to the cut out edge

LOCKS

- Standard on all credenzas, storage cabinets, lateral files, pedestals & benches
- Lock on all credenzas, cabinets and pedestals is always on the bottom drawer
- All components within a workstation or private office can be keyed alike. For up to 40 key numbers, the lead times are standard. For projects larger than 40 offices, additional lock numbers are available. Delivery will be extended an additional week at no upcharge
- To order specified keying, tag each component of each workstation or office with a lock number between 401 and 440.
- Components may be ordered without locks at no additional charge. Specify **NL**
- Storage cabinets and pedestal with box/box/file drawer - only five drawer and lower box drawer are locking. Credenza file drawer lock secures both drawers.

HUTCHES & OVERHEAD STORAGE

- Available in 60", 72" and 84" widths
- Hutches with full back feature one small hole in each corner for wire pass through
- 15.75" height clearance between worksurface and underside of hutch
- Overhead Storage Cabinets have full width lower storage with center divider
- Hutches feature 1" x 2" steel support frame in Tungsten (**TUN**), Black (**BLK**) or Designer White (**DWT**)
- Laminate and tempered glass sliding doors available
- Hutches cannot be placed on desks with laminate end panels
- Wall hung mounting rails are provided; wall fastener hardware is not included.
- Locks are not available
- Energy efficient LED lighting available (page 112)

TABLES

- 1" x 2.5" open metal frame leg finished in Tungsten (**TUN**), Black (**BLK**) or Designer White (**DWT**)
- Standard with 1" thick top and Global's preferred edging in matching color
- 120" and 144" wide table tops with center leg are shipped in two pieces
- Tables which have a span of 54" or wider are standard with 2"H metal support channel(s)
- Grommets and power block cutouts are available for most tables. Due to support channel location(s), contact Customer Care for details.
- Available standard with levelers or locking casters

KEYBOARDS

- Keyboard tray adapter kits are required to accommodate worksurface support channels on the following: freestanding desks with metal legs, returns with metal legs, bridges for desks and returns with metal legs, and returns with bookshelf.

TACKBOARDS

- Tackboards available for hutches and overhead units.
- Available to fit 60", 72" and 84" widths
- Available in:
 - Grade 1:** Agate II
 - Grade 1:** Hudson, Jenny, Lola, Quilt, Terrace, Urban, Waterfall
 - Grade 2:** Accent, Blink, Brinx, Couture, Crescent, Imprint, Mariposa, Match, Quadrille, Renewal, Replay, Silhouette
 - Grade 3:** Anchorage, Identity, Merge, Stitch
 - Grade 4:** Presidio
 - Grade 5:** Momentum: **Universe (extended lead time)**
- Contact customer care for COM selection.

CUSHIONS

- Sold separately.
- Cushions available in all Global seating fabrics. Contact customer care for COM selection and procedure.

CONNECTION

- Metal flat plates and wood screws are provided for connection between two units.

SPECIAL SIZES

- Custom widths, depths and heights are available, but require a custom quote. Please contact Customer Care for more information.
- Custom orders must indicate the "custom quote number" and list price as provided by Customer Care.
- Changes to a custom quote are not permissible. Any revisions will necessitate a new quotation.

TASK LIGHTS

- Optional, energy efficient LED task lights (ultra slim design) are available for mounting under hutches and overheads
- Hutches and overhead storage cabinets are pre-drilled for easy installation
- Available in 12", 20" and 40" widths

WIRE MANAGEMENT

- 2"W x 2"H
- Plastic tray flexes to receive and hold electrical and data wires
- Quickly attaches with double-sided tape (included)

MONOPOST

- Standard support for conference tops; support for select desks and returns
- 4" square post with 10" square base

PLANTERS

- Plastic planter pots provided
- 8½" diameter x 8"H
- Available in Black (**BK**) or White (**WT**). Must specify at time of order.

SHIPPING

- Items are shipped R.T.A. (Ready To Assemble) unless otherwise noted
- Shipped in 1 carton unless otherwise noted
- Connecting hardware included

1. SPECIFY MODEL NUMBER

2. SPECIFY FINISH

Top Finishes:

ACJ	Absolute Acajou
ASN	Asian Night
AWC	Avant Cherry
AWH	Avant Honey
CMB	Clear Maple
DES	Dark Espresso
DWT	Designer White
HGT	Hayden Grey
TWL	Tiger Walnut
WHE	Walnut Heights
WCR	Winter Cherry
WHC	White Chocolate

Base Finishes:

ACJ	Absolute Acajou
ASN	Asian Night
AWC	Avant Cherry
AWH	Avant Honey
CMB	Clear Maple
DES	Dark Espresso
DWT	Designer White
HGT	Hayden Grey
TWL	Tiger Walnut
WHE	Walnut Heights
WCR	Winter Cherry
WHC	White Chocolate

Door, Drawer and Cabinet Front Finishes

ACJ	Absolute Acajou
ASN	Asian Night
AWC	Avant Cherry
AWH	Avant Honey
CMB	Clear Maple
DES	Dark Espresso
DWT	Designer White
HGT	Hayden Grey
TWL	Tiger Walnut
WHE	Walnut Heights
WCR	Winter Cherry
WHC	White Chocolate

Monopost Finishes

4" square monopost is available in Tungsten (**TUN**), Black (**BLK**) or Designer White (**DWT**)

Metal Frame Desk Legs

1" x 2" metal frame legs are available in Tungsten (**TUN**), Black (**BLK**) or Designer White (**DWT**)

For detailed finish specification guidelines, please download the **Princeton Design Guide** at www.globalfurnituregroup.com

Planters

Planter pots are standard in white. Available in Black (**BK**) at no upcharge. **MUST SPECIFY** at time of order placement.

Metal Frame Table Legs

1" x 2.5" metal frame legs are available in Tungsten (**TUN**), Black (**BLK**) or Designer White (**DWT**)

3. SPECIFY OPTIONS

GROMMETS

- One grommet in satin anodized finish is standard on many components, as specified
- Additional grommets may be available in other standard worksurface locations (left, center or right)
- Order as: **Left POG1, Center POG2 or Right POG3: ADD \$69**

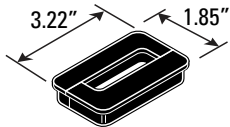

- Worksurface Grommet hole dimensions are 3.22" W x 1.85"D
- Standard grommet position is POG2 in desks, returns, bridges and conference tops
- Modesty panel pass through hole dimensions are 3.43"W x 2"H
- Grommets may be placed at non-standard locations. Order as **PCSG - Add \$69**. A drawing must be supplied with vertical and horizontal dimensions to the center of the cut-out (as in drawing above)
- Components that come standard with grommet may be ordered without a grommet. Order as **RSG - Add \$37**.
- Grommet only available at POG2 on the following 48"W worksurfaces:
 - Desk: PN2448DK, PN3048DK, PN3648DK
 - Return-Flush: PN2448RFR, PN2448RFL

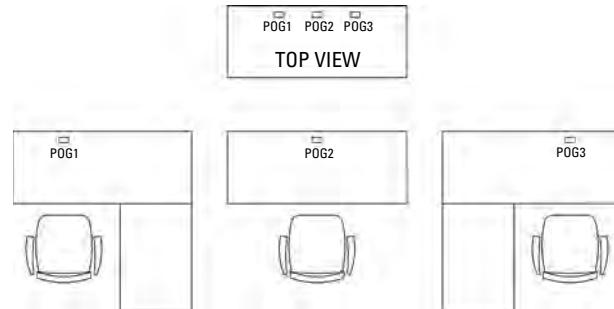

POWER BLOCK

- Power Block (model **PGDPS20**) with 1 power outlet and 1 data opening, 12 foot long power cord, for mounting under worksurfaces or inside of laminate end panels
- Power Block (model **PGDPS21**) with 2 power outlets and 1 data opening, 12 foot long power cord, for mounting under worksurfaces or inside of laminate end panels
- Power Bar (model **PGDPS41**) with 4 power outlets and 1 data opening, 12 foot long power cord, for mounting behind credenza pull-out shelf or at back of credenza opening
- Rectangular shape. Finished in Tungsten (**TUN**)
- Power Block dimensions:
 - PGDPS20: 2.5"D x 3.5"W x 2.25"H
 - PGDPS21: 2.5"D x 6.75"W x 2.25"H
- Power Bar dimensions:
 - PGDPS41: 2.5"D x 10.25"W x 2.22"H

FREESTANDING DESKS - LAMINATE END PANELS **MODEL#** **DIMENSIONS** **FREIGHT CLASS** **WT/LBS.** **CUBIC FT.** **LIST PRICE** **HP ADD**

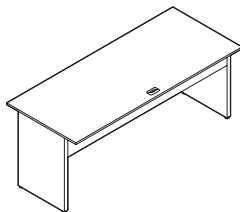

Freestanding Desk

D x W x H							
PN2484DK	24 x 84 x 29	65	117	5	\$776	\$89	
PN2478DK	24 x 78 x 29	70	111	5	\$753	\$88	
PN2472DK	24 x 72 x 29	70	105	5	\$723	\$87	
PN2466DK	24 x 66 x 29	65	101	4	\$714	\$87	
PN2460DK	24 x 60 x 29	65	95	4	\$680	\$87	
PN2454DK	24 x 54 x 29	60	95	3	\$680	\$88	
PN2448DK	24 x 48 x 29	70	84	4	\$652	\$85	
PN3084DK	30 x 84 x 29	70	133	6.50	\$788	\$91	
PN3078DK	30 x 78 x 29	70	127	6	\$767	\$90	
PN3072DK	30 x 72 x 29	70	120	5.50	\$742	\$90	
PN3066DK	30 x 66 x 29	65	114	5	\$720	\$89	
PN3060DK	30 x 60 x 29	70	109	5	\$694	\$87	
PN3054DK	30 x 54 x 29	60	108	3.25	\$694	\$88	
PN3048DK	30 x 48 x 29	65	98	4	\$662	\$87	
PN3684DK	36 x 84 x 29	70	152	8	\$830	\$101	
PN3678DK	36 x 78 x 29	70	145	7	\$806	\$98	
PN3672DK	36 x 72 x 29	70	138	7	\$792	\$95	
PN3666DK	36 x 66 x 29	70	130	6	\$757	\$90	
PN3660DK	36 x 60 x 29	70	117	6	\$731	\$88	
PN3654DK	36 x 54 x 29	60	120	4	\$731	\$89	
PN3648DK	36 x 48 x 29	70	111.50	6.50	\$670	\$87	

Standard with inset end panel on both ends and 10" h modesty panel with pass through grommet. Connects to flush return with laminate end panel, bridges for laminate end panel desks, flush return with bookshelf, flush conference tops. Can be placed over 27"H freestanding returns or 23"H/27"H credenzas. Grommet in worksurface. Shipped in 2 cartons.

RETURNS - LAMINATE END PANELS **MODEL#** **DIMENSIONS** **FREIGHT CLASS** **WT/LBS.** **CUBIC FT.** **LIST PRICE** **HP ADD**

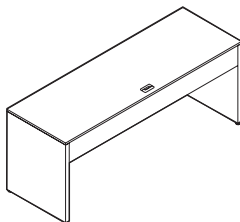

Freestanding Return- 29" H

PN248429R	24 x 84 x 29	65	131	5	\$758	\$100
PN247829R	24 x 78 x 29	65	127	5	\$736	\$96
PN247229R	24 x 72 x 29	65	123	5	\$716	\$91
PN246629R	24 x 66 x 29	65	118	4	\$681	\$89
PN246029R	24 x 60 x 29	65	112	4	\$676	\$87

Standard with flush laminate 1.5" thick end panels. 10" h thick modesty panel without pass through grommet. Connects to flush return with laminate end panel, bridges for laminate end panel desks, flush return with bookshelf, flush conference tops. Can be placed over 27"H freestanding returns or 23"H/27"H credenzas. Grommet in worksurface.

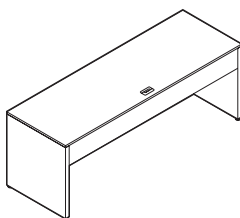

Freestanding Return- 27" H

PN248427R	24 x 84 x 27	65	129	5	\$748	\$97
PN247827R	24 x 78 x 27	65	125	5	\$725	\$94
PN247227R	24 x 72 x 27	65	120	5	\$705	\$90
PN246627R	24 x 66 x 27	65	116	4	\$684	\$88
PN246027R	24 x 60 x 27	65	109	4	\$639	\$86

Standard with flush laminate 1.5" thick end panels. 10" h thick modesty panel without pass through grommet. Supports overlapping return with laminate end panel, overlapping bridge for laminate end panel desks, overlapping return with bookshelf, overlapping conference top. Can be placed under desk. Grommet in worksurface.

Required Specifications

Top finish
Base finish

Optional Specifications

HP laminate
POG1, POG3 - additional grommet
PCSG - custom grommet
RSG - remove grommet

Accessories

Power block Wire manager
Keyboard tray Desktop screen
Keyboard mechanism (*not available on 27" H return*)

RETURNS - LAMINATE END PANELS

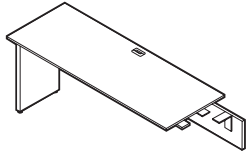

Flush Return - 29" H - LEFT

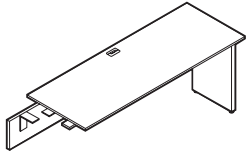

Flush Return - 29" H - RIGHT

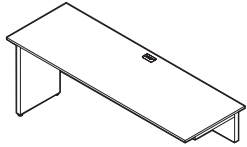

Overlapping Return - 29" H - LEFT

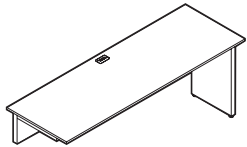

Overlapping Return - 29" H - RIGHT

MODEL#	DIMENSIONS D x W x H	FREIGHT CLASS	WT/LBS.	CUBIC FT.	LIST PRICE	HP ADD
PN2472RFL	24 x 72 x 29	70	95	5.50	\$626	\$95
PN2466RFL	24 x 66 x 29	70	90	5	\$604	\$91
PN2460RFL	24 x 60 x 29	70	84	4.50	\$569	\$88
PN2454RFL	24 x 54 x 29	70	78	4	\$555	\$89
PN2448RFL	24 x 48 x 29	70	72	4	\$530	\$86

Return has no pedestal. Standard with inset end panel on **left**. 10" h modesty panel with pass-through grommet. Connects to Freestanding Desk with laminate end panels, **29" H** Freestanding Returns and **29" H** Credenzas. Grommet in worksurface.

PN2472RFR	24 x 72 x 29	70	95	5.50	\$626	\$95
PN2466RFR	24 x 66 x 29	70	90	5	\$604	\$91
PN2460RFR	24 x 60 x 29	70	84	4.50	\$569	\$88
PN2454RFR	24 x 54 x 29	70	88	4	\$555	\$89
PN2448RFR	24 x 48 x 29	70	72	4	\$530	\$86

Return has no pedestal. Standard with inset end panel on **right**. 10" h modesty panel with pass-through grommet. Connects to Freestanding Desk with laminate end panels, **29" H** Freestanding Returns and **29" H** Credenzas. Grommet in worksurface.

PN2484ROL	24 x 84 x 29	70	118	6	\$694	\$79
PN2478ROL	24 x 78 x 29	65	126	5	\$646	\$78
PN2472ROL	24 x 72 x 29	70	104	5	\$625	\$73

Standard with inset laminate end panel on **left** and 10" h modesty panel with pass-through grommet. Overlaps **27" H** Credenza and **27" H** Freestanding Returns. Grommet in worksurface. 1" spacer included.

PN2484ROR	24 x 84 x 29	70	118	6	\$694	\$79
PN2478ROR	24 x 78 x 29	65	126	5	\$646	\$78
PN2472ROR	24 x 72 x 29	70	104	5	\$625	\$73

Standard with inset laminate end panel on **right** and 10" h modesty panel with pass-through grommet. Overlaps **27" H** Credenza and **27" H** Freestanding Returns. Grommet in worksurface. 1" spacer included.

Required Specifications

Top finish
Base finish

Optional Specifications

HP laminate
POG1, POG3 - additional grommet
PCSG - custom grommet
RSG - remove grommet

Accessories

Power block
Keyboard tray
Desktop screen
Wire manager
Keyboard mechanism

BRIDGES FOR LAMINATE END PANEL DESKS

MODEL# DIMENSIONS FREIGHT CLASS WT/LBS. CUBIC FT. LIST PRICE HP ADD

D x W x H

PN2454BF	24 x 54 x 12	65	97	3.50	\$494	\$78
PN2448BF	24 x 48 x 12	70	77	4.50	\$450	\$68
PN2442BF	24 x 42 x 12	70	70	4	\$429	\$65
PN2436BF	24 x 36 x 12	70	63	4	\$403	\$63

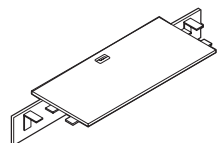

Flush Bridge

Standard with 10" h modesty panel with pass-through grommet. Connects between any two: Freestanding Desk with laminate end panels, **29" H** Freestanding Returns, Conference top for U configurations or **29" H** Credenzas opening. Subtop finish is Granite with black edge. Grommet in worksurface.

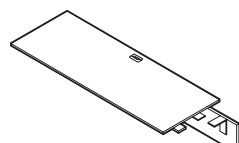

Overlapping Bridge - LEFT*

PN2478BOL	24 x 78 x 12	65	119	4	\$591	\$87
PN2472BOL	24 x 72 x 12	70	96	5	\$561	\$80
PN2466BOL	24 x 66 x 12	70	90	4.50	\$542	\$73
PN2460BOL	24 x 60 x 12	70	83	4.50	\$534	\$71

Standard with 10" h modesty panel with pass-through grommet. Connects Freestanding Desk with laminate end panels, **29" H** Freestanding Returns, Conference top for U configurations on one end, and overlaps **27" H** Credenza or **27" H** Freestanding Return on other end. Subtop finish is Granite with black edge. Grommet in worksurface. Includes 1" spacer, one side only.

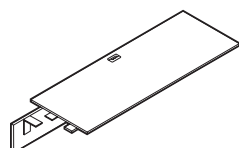

Overlapping Bridge - RIGHT*

PN2478BOR	24 x 78 x 12	65	119	4	\$591	\$87
PN2472BOR	24 x 72 x 12	70	96	5	\$561	\$80
PN2466BOR	24 x 66 x 12	70	90	4.50	\$542	\$73
PN2460BOR	24 x 60 x 12	70	83	4.50	\$534	\$71

Standard with 10" h modesty panel with pass-through grommet. Connects Freestanding Desk with laminate end panels, **29" H** Freestanding Returns, Conference top for U configurations on one end, and overlaps **27" H** Credenza or **27" H** Freestanding Return on other end. Subtop finish is Granite with black edge. Grommet in worksurface. Includes 1" spacer, one side only.

Required Specifications

Top finish
Base finish

Optional Specifications

HP laminate
POG1, POG3 - additional grommet*
PCSG - custom grommet
RSG - remove grommet

Accessories

Power block Wire manager
Keyboard tray Keyboard mechanism
Desktop screen

FREESTANDING DESKS WITH METAL LEGS

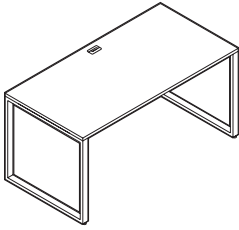

Freestanding Desk with Metal Legs

MODEL#	DIMENSIONS D x W x H	FREIGHT CLASS	WT/LBS.	CUBIC FT.	LIST PRICE	HP ADD
PN2484DM	24 x 84 x 29	250	111	43.41	\$1199	\$189
PN2478DM	24 x 78 x 29	250	109	41.92	\$1109	\$176
PN2472DM	24 x 72 x 29	250	106	38.92	\$972	\$155
PN2466DM	24 x 66 x 29	250	102	31.44	\$963	\$153
PN2460DM	24 x 60 x 29	250	91	29.94	\$942	\$151
PN2454DM	24 x 54 x 29	250	88	29.94	\$914	\$146
PN2448DM	24 x 48 x 29	250	76	28.44	\$809	\$130
PN3084DM	30 x 84 x 29	250	137	53.89	\$1248	\$196
PN3078DM	30 x 78 x 29	250	124	52.40	\$1159	\$184
PN3072DM	30 x 72 x 29	250	117	47.90	\$1038	\$164
PN3066DM	30 x 66 x 29	250	110	38.92	\$1004	\$159
PN3060DM	30 x 60 x 29	250	104	38.17	\$972	\$155
PN3054DM	30 x 54 x 29	250	99	37.43	\$952	\$152
PN3048DM	30 x 48 x 29	250	82	35.93	\$841	\$135
PN3684DM	36 x 84 x 29	250	154	65.87	\$1416	\$222
PN3678DM	36 x 78 x 29	250	139	62.87	\$1297	\$203
PN3672DM	36 x 72 x 29	250	132	59.88	\$1262	\$198
PN3666DM	36 x 66 x 29	250	123	47.16	\$1106	\$175
PN3660DM	36 x 60 x 29	250	117	46.41	\$1069	\$169
PN3654DM	36 x 54 x 29	250	106	44.91	\$1009	\$160
PN3648DM	36 x 48 x 29	250	92	44.91	\$913	\$146

Standard with two 1" x 2" metal open frame legs with support channel(s). Connects to flush returns with metal leg, bridges for desks and returns with metal leg, flush return with bookshelf and flush conference tops. Grommet in worksurface. Shipped in 3 cartons.

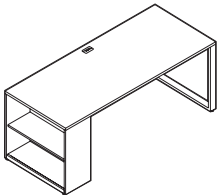

**LEFT
Freestanding Desk with Bookshelf***

PN3060DBL	30 x 60 x 29	250	123	51.65	\$1054	\$176
PN3066DBL	30 x 66 x 29	250	129	52.40	\$1164	\$192
PN3072DBL	30 x 72 x 29	250	136	61.38	\$1199	\$195
PN3078DBL	30 x 78 x 29	250	150	65.87	\$1296	\$212
PN3084DBL	30 x 84 x 29	250	156	67.37	\$1365	\$238
PN3672DBL	36 x 72 x 29	250	154	73.35	\$1246	\$195
PN3678DBL	36 x 78 x 29	250	161	76.35	\$1352	\$212
PN3684DBL	36 x 84 x 29	250	176	79.34	\$1524	\$238

12"D Bookcase with adjustable shelf on **left**. One 1" x 2" metal open frame leg with support channel(s). Right side connects to flush returns with metal leg, bridges for desks and returns with metal leg, flush return with bookshelf, flush conference tops. Grommet in worksurface. Shipped in 3 cartons.

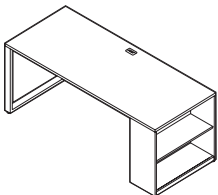

**RIGHT
Freestanding Desk with Bookshelf***

PN3060DBR	30 x 60 x 29	250	123	51.65	\$1054	\$162
PN3066DBR	30 x 66 x 29	250	129	52.40	\$1164	\$179
PN3072DBR	30 x 72 x 29	250	136	61.38	\$1199	\$184
PN3078DBR	30 x 78 x 29	250	150	65.87	\$1296	\$194
PN3084DBR	30 x 84 x 29	250	156	67.37	\$1365	\$208
PN3672DBR	36 x 72 x 29	250	154	73.35	\$1246	\$189
PN3678DBR	36 x 78 x 29	250	161	76.35	\$1352	\$203
PN3684DBR	36 x 84 x 29	250	176	79.34	\$1524	\$214

12"D Bookcase with adjustable shelf on **right**. One 1" x 2" metal open frame leg with support channel(s). Left side connects to flush returns with metal leg, bridges for desks and returns with metal leg, flush return with bookshelf, flush conference tops. Grommet in worksurface. Shipped in 3 cartons.

Required Specifications

Top finish
Base finish*
Leg finish*

Optional Specifications

HP laminate
POG1, POG3 - additional grommet
PCSG - custom grommet
RSG - remove grommet

Accessories

Power block
Keyboard tray
Desktop screen
Keyboard tray mounting kit*
Wire manager
Keyboard mechanism

RETURNS WITH METAL LEGS

MODEL# DIMENSIONS FREIGHT CLASS WT/LBS. CUBIC FT. LIST PRICE HP ADD

D x W x H

PN2448FML	24 x 48 x 29	150	56	12	\$559	\$85
PN2454FML	24 x 54 x 29	150	68	13	\$671	\$101
PN2460FML	24 x 60 x 29	150	71	13	\$703	\$107
PN2466FML	24 x 66 x 29	150	82	14	\$731	\$112
PN2472FML	24 x 72 x 29	150	86	20	\$754	\$115
PN2478FML	24 x 78 x 29	150	89	21	\$840	\$127

PN3048FML	30 x 48 x 29	150	61	15	\$593	\$90
PN3054FML	30 x 54 x 29	150	78	16	\$700	\$106
PN3060FML	30 x 60 x 29	150	82	16.50	\$732	\$112
PN3066FML	30 x 66 x 29	150	89	17	\$758	\$115
PN3072FML	30 x 72 x 29	150	96	23	\$805	\$122
PN3078FML	30 x 78 x 29	250	103	26	\$881	\$133

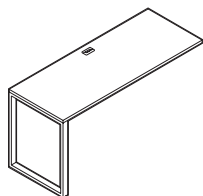

LEFT

Flush Return with Metal Leg

1" x 2" metal open frame leg with support channel(s) on **left**. Connects to freestanding desk with metal legs, freestanding desk with bookshelf and metal leg, 29"H credenza opening. Grommet in worksurface. Shipped in 2 cartons.

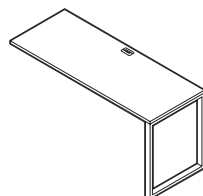

RIGHT

Flush Return with Metal Leg

PN2448FMR	24 x 48 x 29	150	56	12	\$559	\$85
PN2454FMR	24 x 54 x 29	150	68	13	\$671	\$101
PN2460FMR	24 x 60 x 29	150	71	13	\$703	\$107
PN2466FMR	24 x 66 x 29	150	82	14	\$731	\$112
PN2472FMR	24 x 72 x 29	150	86	20	\$754	\$115
PN2478FMR	24 x 78 x 29	150	89	21	\$840	\$127

PN3048FMR	30 x 48 x 29	150	61	7.50	\$593	\$90
PN3054FMR	30 x 54 x 29	150	78	16	\$700	\$106
PN3060FMR	30 x 60 x 29	150	83	16.50	\$732	\$112
PN3066FMR	30 x 66 x 29	150	89	17	\$758	\$115
PN3072FMR	30 x 72 x 29	150	96	23	\$805	\$122
PN3078FMR	30 x 78 x 29	250	103	26	\$881	\$133

1" x 2" metal open frame leg with support channel(s) on **right**. Connects to freestanding desk with metal legs, freestanding desk with bookshelf and metal leg, 29"H credenza opening. Grommet in worksurface. Shipped in 2 cartons.

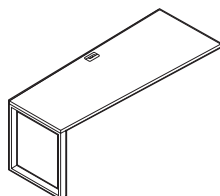

LEFT

Flush Wedge Return w/Metal Leg

PN3048FTL	30 x 48 x 29	150	61	15	\$586	\$89
PN3054FTL	30 x 54 x 29	150	78	16	\$691	\$105
PN3060FTL	30 x 60 x 29	150	83	16.50	\$732	\$112
PN3066FTL	30 x 66 x 29	150	89	17	\$773	\$117
PN3072FTL	30 x 72 x 29	150	96	23	\$805	\$122

1" x 2" metal open frame leg with support channel(s) on **left**. 30"D has 24"D leg. 36"D has 30"D leg. Connects to freestanding desk with metal legs, freestanding desk with bookshelf and metal leg, 29"H credenza opening. Grommet in worksurface. Shipped in 2 cartons.

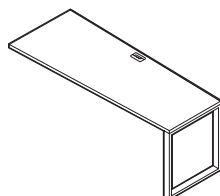

RIGHT

Flush Wedge Return w/Metal Leg

PN3048FTR	30 x 48 x 29	150	61	15	\$586	\$89
PN3054FTR	30 x 54 x 29	150	78	16	\$691	\$105
PN3060FTR	30 x 60 x 29	150	83	16.50	\$732	\$112
PN3066FTR	30 x 66 x 29	150	89	17	\$773	\$117
PN3072FTR	30 x 72 x 29	150	96	23	\$805	\$122

1" x 2" metal open frame leg with support channel(s) on **right**. 30"D has 24"D leg. 36"D has 30"D leg. Connects to freestanding desk with metal legs, freestanding desk with bookshelf and metal leg, 29"H credenza opening. Grommet in worksurface. Shipped in 2 cartons.

Required Specifications

Top finish
Leg finish

Optional Specifications

HP laminate
POG1, POG3 - additional grommet
PCSG - custom grommet
RSG - remove grommet

Accessories

Power block
Keyboard tray
Desktop screen
Keyboard tray mounting kit
Wire manager
Keyboard mechanism

OVERLAPPING RETURNS WITH METAL LEGS

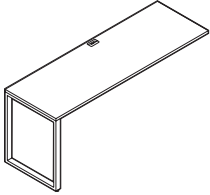

LEFT
Overlapping Return w/Metal Leg

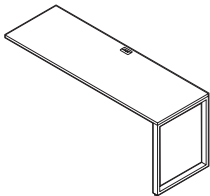

RIGHT
Overlapping Return w/Metal Leg

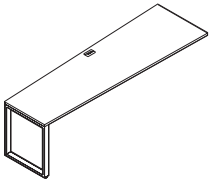

LEFT
Overlapping Wedge Return w/Metal Leg

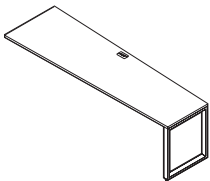

RIGHT
Overlapping Wedge Return w/Metal Leg

MODEL#	DIMENSIONS D x W x H	FREIGHT CLASS	WT./LBS.	CUBIC FT.	LIST PRICE	HP ADD
PN2460OML	24 x 60 x 29	150	71	13	\$627	\$95
PN2466OML	24 x 66 x 29	150	82	14	\$645	\$98
PN2472OML	24 x 72 x 29	150	86	20	\$668	\$101
PN2478OML	24 x 78 x 29	150	89	21	\$796	\$121
PN2484OML	24 x 84 x 29	150	91	22	\$920	\$140
PN3060OML	30 x 60 x 29	150	83	16.50	\$655	\$99
PN3066OML	30 x 66 x 29	150	89	17	\$679	\$103
PN3072OML	30 x 72 x 29	150	96	23	\$718	\$109
PN3078OML	30 x 78 x 29	250	103	26	\$853	\$130
PN3084OML	30 x 84 x 29	150	116	27	\$954	\$144

1" x 2" metal open frame leg with support channels on **left**. Overlaps 27"H credenza opening. Grommet in worksurface. Shipped in 2 cartons.

PN2460OMR	24 x 60 x 29	150	71	13	\$627	\$95
PN2466OMR	24 x 66 x 29	150	82	14	\$645	\$98
PN2472OMR	24 x 72 x 29	150	86	20	\$668	\$101
PN2478OMR	24 x 78 x 29	150	89	21	\$796	\$121
PN2484OMR	24 x 84 x 29	150	91	22	\$920	\$140
PN3060OMR	30 x 60 x 29	150	83	16.50	\$655	\$99
PN3066OMR	30 x 66 x 29	150	89	17	\$679	\$103
PN3072OMR	30 x 72 x 29	150	96	23	\$718	\$109
PN3078OMR	30 x 78 x 29	250	103	26	\$853	\$130
PN3084OMR	30 x 84 x 29	150	137	27	\$954	\$144

1" x 2" metal open frame leg with support channels on **right**. Overlaps 27"H credenza opening. Grommet in worksurface. Shipped in 2 cartons.

PN3060OTL	30 x 60 x 29	150	83	16.50	\$669	\$101
PN3066OTL	30 x 66 x 29	150	89	17	\$692	\$105
PN3072OTL	30 x 72 x 29	150	96	23	\$725	\$110
PN3078OTL	30 x 78 x 29	250	103	26	\$867	\$131
PN3084OTL	30 x 84 x 29	150	116	27	\$968	\$146

1" x 2" metal open frame leg with support channel on **left**. 30"D has 24"D leg. 36"D has 30"D leg. Overlaps 27"H credenza opening. Grommet in worksurface. Includes 1" spacer. Shipped in 2 cartons.

PN3060OTR	30 x 60 x 29	150	83	16.50	\$669	\$101
PN3066OTR	30 x 66 x 29	150	89	17	\$692	\$105
PN3072OTR	30 x 72 x 29	150	96	23	\$725	\$110
PN3078OTR	30 x 78 x 29	250	103	26	\$867	\$131
PN3084OTR	30 x 84 x 29	150	116	27	\$968	\$146

1" x 2" metal open frame leg with support channel on **right**. 30"D has 24"D leg. 36"D has 30"D leg. Overlaps 27"H credenza opening. Grommet in worksurface. Includes 1" spacer. Shipped in 2 cartons.

Required Specifications

Top finish
Leg finish

Optional Specifications

HP laminate
POG1, POG3 - additional grommet
PCSG - custom grommet
RSG - remove grommet

Accessories

Power block
Keyboard tray
Desktop screen
Keyboard tray mounting kit
Wire manager
Keyboard mechanism

OVERLAPPING RETURNS WITH METAL LEGS

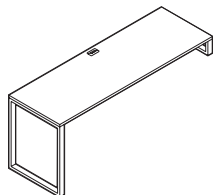

LEFT

Overlapping Return w/Metal Leg and Spacer for 23”H Credenza

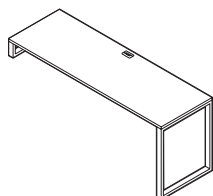

RIGHT

Overlapping Return w/Metal Leg and Spacer for 23”H Credenza

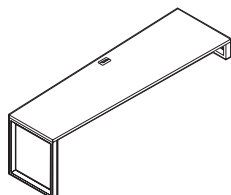

LEFT

Overlapping Wedge Return w/Metal Leg and Spacer for 23”H Credenza

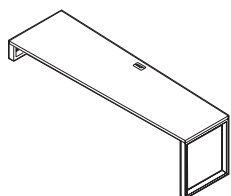

RIGHT

Overlapping Wedge Return w/Metal Leg and Spacer for 23”H Credenza

MODEL#	DIMENSIONS D x W x H	FREIGHT CLASS	WT/LBS.	CUBIC FT.	LIST PRICE	HP ADD
PN2460SOL	24 x 60 x 29	250	83	23.95	\$921	\$140
PN2466SOL	24 x 66 x 29	250	94	25.45	\$949	\$144
PN2472SOL	24 x 72 x 29	250	98	34.43	\$975	\$148
PN2478SOL	24 x 78 x 29	250	101	35.93	\$1059	\$160
PN2484SOL	24 x 84 x 29	250	103	37.43	\$1116	\$169
PN3060SOL	30 x 60 x 29	250	95	26.20	\$980	\$149
PN3066SOL	30 x 66 x 29	250	101	26.95	\$1009	\$153
PN3072SOL	30 x 72 x 29	250	108	35.93	\$1034	\$156
PN3078SOL	30 x 78 x 29	250	115	40.42	\$1107	\$167
PN3084SOL	30 x 84 x 29	250	128	41.92	\$1181	\$179

1” x 2” metal frame leg on **left**. One 5”H metal frame spacer with support channel(s). Overlaps 23”H credenza. Grommet in worksurface. Shipped in 3 cartons.

PN2460SOR	24 x 60 x 29	250	83	23.95	\$921	\$140
PN2466SOR	24 x 66 x 29	250	94	25.45	\$949	\$144
PN2472SOR	24 x 72 x 29	250	98	34.43	\$975	\$148
PN2478SOR	24 x 78 x 29	250	101	35.93	\$1059	\$160
PN2484SOR	24 x 84 x 29	250	103	37.43	\$1116	\$169
PN3060SOR	30 x 60 x 29	250	95	26.20	\$980	\$149
PN3066SOR	30 x 66 x 29	250	101	26.95	\$1009	\$153
PN3072SOR	30 x 72 x 29	250	108	35.93	\$1034	\$156
PN3078SOR	30 x 78 x 29	250	115	40.42	\$1107	\$167
PN3084SOR	30 x 84 x 29	250	128	41.92	\$1181	\$179

1” x 2” metal frame leg on **right**. One 5”H metal frame spacer with support channel(s). Overlaps 23”H credenza. Grommet in worksurface. Shipped in 3 cartons.

PN3060TSL	30 x 60 x 29	250	95	26.20	\$963	\$146
PN3066TSL	30 x 66 x 29	250	101	26.95	\$999	\$152
PN3072TSL	30 x 72 x 29	250	108	35.93	\$1024	\$155
PN3078TSL	30 x 78 x 29	250	115	40.42	\$1097	\$166
PN3084TSL	30 x 84 x 29	250	128	41.92	\$1161	\$176

1” x 2” metal open frame leg on **left**. One 5”H frame spacer with support channel(s). 24”D leg and 30”D spacer. Overlaps 23”H credenza. Grommet in worksurface. Shipped in 3 cartons.

PN3060TSR	30 x 60 x 29	250	95	26.20	\$963	\$146
PN3066TSR	30 x 66 x 29	250	101	26.95	\$999	\$152
PN3072TSR	30 x 72 x 29	250	108	35.93	\$1024	\$155
PN3078TSR	30 x 78 x 29	250	115	40.42	\$1097	\$166
PN3084TSR	30 x 84 x 29	250	128	41.92	\$1161	\$176

1” x 2” metal frame leg on **right**. One 5”H frame spacer with support channel(s). 24”D leg and 30”D spacer. Overlaps 23”H credenza. Grommet in worksurface. Shipped in 3 cartons.

Required Specifications

Top finish
Leg finish

Optional Specifications

HP laminate
POG1, POG3 - additional grommet
PCSG - custom grommet
RSG - remove grommet

Accessories

Power block
Keyboard tray
Desktop screen
Keyboard tray mounting kit
Wire manager
Keyboard mechanism

BRIDGES FOR DESKS + RETURNS W/ METAL LEGS

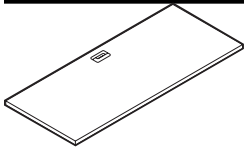

Flush Bridge for Metal Leg Configurations

MODEL#	DIMENSIONS D x W x H	FREIGHT CLASS	WT/LBS.	CUBIC FT.	LIST PRICE	HP ADD
PN2436BFM	24 x 36 x 1	70	31	2	\$263	\$58
PN2442BFM	24 x 42 x 1	70	40	2.50	\$268	\$60
PN2448BFM	24 x 48 x 1	85	44	3	\$282	\$62
PN2454BFM	24 x 54 x 1	70	51	3	\$383	\$84

Connects between any two: freestanding desk with metal legs, freestanding desk with bookshelf and metal leg, conference top for U configurations, 29"H credenza opening. Grommet in worksurface.

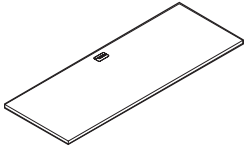

**LEFT
Overlapping Bridge for Metal Leg Configurations**

PN2460OBL	24 x 60 x 2	70	51	3	\$366	\$75
PN2466OBL	24 x 66 x 2	70	62	3.25	\$379	\$78
PN2472OBL	24 x 72 x 2	92.5	66	6.50	\$386	\$79
PN2478OBL	24 x 78 x 2	92.5	76	6.50	\$523	\$106

Connects freestanding desk with metal legs, freestanding desk with bookshelf and metal leg, conference top for U configurations flush on one end, and overlaps 27"H credenza opening on the other end. Includes 1" spacer. Grommet in worksurface.

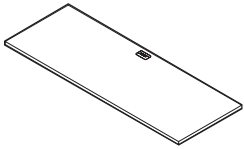

**RIGHT
Overlapping Bridge for Metal Leg Configurations**

PN2460OBR	24 x 60 x 2	70	51	3	\$366	\$75
PN2466OBR	24 x 66 x 2	70	62	3.25	\$379	\$78
PN2472OBR	24 x 72 x 2	92.5	66	6.50	\$386	\$79
PN2478OBR	24 x 78 x 2	92.5	76	6.50	\$523	\$106

Connects freestanding desk with metal legs, freestanding desk with bookshelf and metal leg, conference top for U configurations flush on one end, and overlaps 27"H credenza opening on the other end. Includes 1" spacer. Grommet in worksurface.

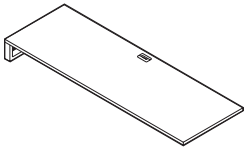

**LEFT
Overlapping Bridge with Metal Spacer for 23"H Credenza***

PN2460OSL	24 x 60 x 6	125	63	9	\$605	\$132
PN2466OSL	24 x 66 x 6	125	74	9.50	\$635	\$139
PN2472OSL	24 x 72 x 6	150	78	16	\$656	\$143
PN2478OSL	24 x 78 x 6	150	88	16	\$742	\$161

One 5"H metal frame spacer with support channel(s). Connects flush on **right** side to freestanding desk with metal legs, freestanding desk with bookshelf and metal leg, or conference top for U configurations. Overlaps 23"H credenza opening on the **left**. Grommet in worksurface. Shipped in 2 cartons.

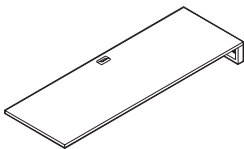

**RIGHT
Overlapping Bridge with Metal Spacer for 23"H Credenza***

PN2460OSR	24 x 60 x 6	125	63	9	\$605	\$132
PN2466OSR	24 x 66 x 6	125	74	9.50	\$635	\$139
PN2472OSR	24 x 72 x 6	150	78	16	\$656	\$143
PN2478OSR	24 x 78 x 6	150	88	16	\$742	\$161

One 5"H metal frame spacer with support channel(s). Connects flush on **left** side to freestanding desk with metal legs, freestanding desk with bookshelf and metal leg, or conference top for U configurations. Overlaps 23"H credenza opening on the **right**. Grommet in worksurface. Shipped in 2 cartons.

Required Specifications

Top finish
Leg finish*

Optional Specifications

HP laminate
POG1, POG3 - additional grommet
PCSG - custom grommet
RSG - remove grommet

Accessories

Power block
Keyboard tray
Desktop screen
Keyboard tray mounting kit
Wire manager
Keyboard mechanism

RETURNS WITH BOOKSHELF

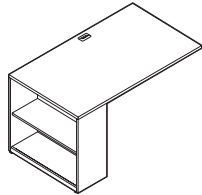

LEFT

Flush Return with Bookshelf

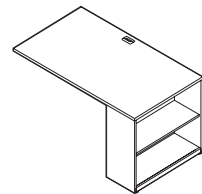

RIGHT

Flush Return with Bookshelf

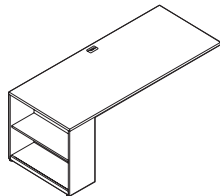

LEFT

Overlapping Return with Bookshelf

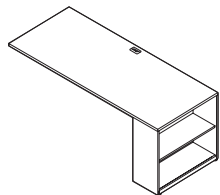

RIGHT

Overlapping Return with Bookshelf

MODEL#	DIMENSIONS D x W x H	FREIGHT CLASS	WT/LBS.	CUBIC FT.	LIST PRICE	HP ADD
PN2460FBL	24 x 60 x 29	150	86	20	\$714	\$108
PN2466FBL	24 x 66 x 29	150	97	20.50	\$813	\$123
PN2472FBL	24 x 72 x 29	250	101	27	\$839	\$126
PN2478FBL	24 x 78 x 29	150	111	27	\$889	\$135
PN2484FBL	24 x 84 x 29	250	106	29	\$939	\$142
PN3060FBL	30 x 60 x 29	150	102	25.50	\$757	\$115
PN3066FBL	30 x 66 x 29	150	108	26	\$860	\$130
PN3072FBL	30 x 72 x 29	250	115	32	\$887	\$134
PN3078FBL	30 x 78 x 29	250	129	35	\$950	\$144
PN3084FBL	30 x 84 x 29	250	135	36	\$1041	\$157

12"D Bookcase with adjustable shelf on **left**. With support channel(s). Connects on **right** side to freestanding desk with metal legs or laminate end panels, 29"H freestanding returns, 29"H credenza opening. Laminate shelf is standard. Grommet in worksurface. Shipped in 2 cartons.

PN2460FBR	24 x 60 x 29	150	86	20	\$714	\$108
PN2466FBR	24 x 66 x 29	150	97	20.50	\$813	\$123
PN2472FBR	24 x 72 x 29	250	101	27	\$839	\$126
PN2478FBR	24 x 78 x 29	150	111	27	\$889	\$135
PN2484FBR	24 x 84 x 29	250	106	29	\$939	\$142
PN3060FBR	30 x 60 x 29	150	102	25.50	\$757	\$115
PN3066FBR	30 x 66 x 29	150	108	26	\$860	\$130
PN3072FBR	30 x 72 x 29	250	115	32	\$887	\$134
PN3078FBR	30 x 78 x 29	250	129	35	\$950	\$144
PN3084FBR	30 x 84 x 29	250	135	36	\$1041	\$157

12"D Bookcase with adjustable shelf on **right**. With support channel(s). Connects on **left** side to freestanding desk with metal legs or laminate end panels, 29"H freestanding returns, 29"H credenza opening. Laminate shelf is standard. Grommet in worksurface. Shipped in 2 cartons.

PN2484RBL	24 x 84 x 29	250	106	29	\$925	\$140
PN2490RBL	24 x 90 x 29	250	110	30	\$1029	\$156
PN2496RBL	24 x 96 x 29	250	123	31	\$1082	\$163
PN3084RBL	30 x 84 x 29	250	135	36	\$963	\$146
PN3090RBL	30 x 90 x 29	250	142	42	\$1054	\$159
PN3096RBL	30 x 96 x 29	250	146	38.50	\$1110	\$168

12"D Bookcase with adjustable shelf on **left**. With support channel(s). **Right** side overlaps 27"H credenza opening, 27"H freestanding return. Laminate shelf is standard. Grommet in worksurface. Shipped in 2 cartons.

PN2484RBR	24 x 84 x 29	250	106	29	\$925	\$140
PN2490RBR	24 x 90 x 29	250	110	30	\$1029	\$156
PN2496RBR	24 x 96 x 29	250	123	31	\$1082	\$163
PN3084RBR	30 x 84 x 29	250	135	36	\$963	\$146
PN3090RBR	30 x 90 x 29	250	142	42	\$1054	\$159
PN3096RBR	30 x 96 x 29	250	146	38.50	\$1110	\$168

12"D Bookcase with adjustable shelf on **right**. With support channel(s). **Left** side overlaps 27"H credenza opening, 27"H freestanding return. Laminate shelf is standard. Grommet in worksurface. Shipped in 2 cartons.

Required Specifications

Top finish
Base finish

Optional Specifications

HP laminate
POG1, POG3 - additional grommet
PCSG - custom grommet
RSG - remove grommet

Accessories

Power block Wire manager
Keyboard tray Keyboard mechanism
Desktop screen
Keyboard tray mounting kit

CONFERENCE TOPS - FLUSH

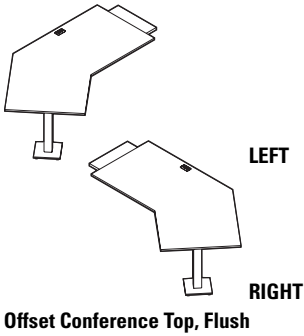

MODEL#	DIMENSIONS D x W x H	FREIGHT CLASS	WT/LBS.	CUBIC FT.	LIST PRICE	HP ADD
PN3066CFL	47 x 66 x 29	150	142	25	\$919	\$118
PN3072CFL	47 x 72 x 29	92.5	52	5	\$959	\$112

PN3066CFR	47 x 66 x 29	150	142	25	\$919	\$118
PN3072CFR	47 x 72 x 29	92.5	52	5	\$959	\$112

Specify PNxxxxCFL for **LEFT** or PNxxxxCFR for **RIGHT**.

Standard with square monopost and base. Connects to freestanding desks with metal legs or laminate end panels, 29"H freestanding returns, 29"H credenza opening. Subtop finish is Granite with black edge. Grommet in worksurface. Shipped in 2 cartons.

Recommended Maximum Modesty Panel Size:

PN3066CFR/CFL: 36"W (PN3613DMF)
 PN3072CFR/CFL: 42"W (PN4213DMF)

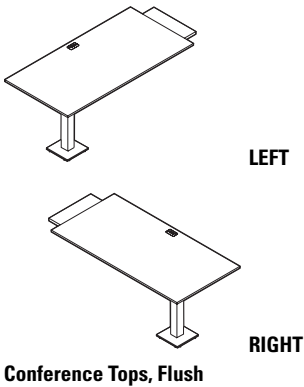

PN2448DFL	24 x 48 x 29	125	55	8.50	\$587	\$84
PN3048DFL	30 x 48 x 29	150	59	5.50	\$626	\$90
PN3060DFL	30 x 60 x 29	125	76	6	\$650	\$94

PN2448DFR	24 x 48 x 29	125	55	8.50	\$587	\$84
PN3048DFR	30 x 48 x 29	150	59	5.50	\$626	\$90
PN3060DFR	30 x 60 x 29	125	76	6	\$650	\$94

Specify PNxxxxDFL for **LEFT** or PNxxxxDFR for **RIGHT**.

Standard with square monopost with base. Connects to Freestanding Desks with metal legs or laminate end panels, 29"H Freestanding Returns or 29"H credenza opening. Subtop finish is Granite with black edge. Grommet in worksurface. Shipped in 2 cartons.

Recommended Maximum Modesty Panel Size:

PN2448DFR/DFL: 30"W (PN3013DMF)
 PN3048DFR/DFL: 30"W (PN3013DMF)
 PN3060DFR/DFL: 36"W (PN3613DMF)

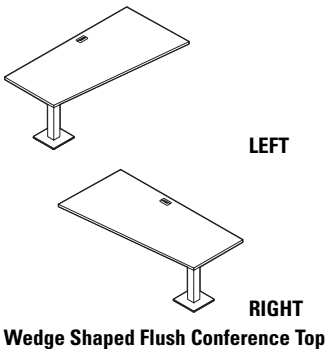

PN3048TFL	30 x 48 x 29	150	59	11	\$626	\$90
PN3060TFL	30 x 60 x 29	125	81	12.50	\$650	\$94

PN3048TFR	30 x 48 x 29	150	59	11	\$626	\$90
PN3060TFR	30 x 60 x 29	125	81	12.50	\$650	\$94

Specify PNxxxxTFL for **LEFT** or PNxxxxTFR for **RIGHT**.

Standard with square monopost with base. 30"D at connecting end, 24"D at monopost end. Connects to Freestanding Desks with metal legs or laminate end panels, 29"H Freestanding Returns or 29"H credenza opening. Subtop finish is Granite with black edge. Grommet in worksurface. Shipped in 2 cartons.

Recommended Maximum Modesty Panel Size:

PN3048TFR/TFL: 30"W (PN3013DMF)
 PN3060TFR/TFL: 36"W (PN3013DMF)

Required Specifications

Top finish
 Monopost finish

Optional Specifications

HP laminate
 PCSG - custom grommet
 RSG - remove grommet

Accessories

Power block
 Keyboard tray
 Desktop screen
 Keyboard tray mounting kit
 Wire manager
 Keyboard mechanism

CONFERENCE TOPS - OVERLAPPING

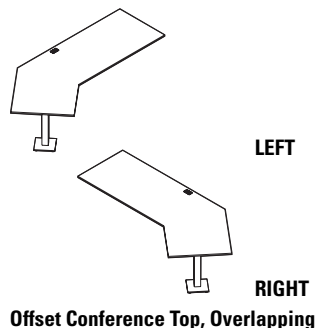

Offset Conference Top, Overlapping

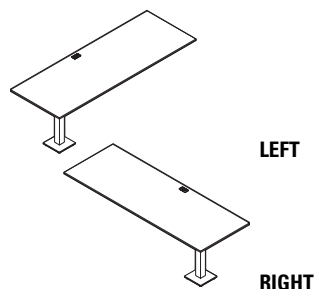

Conference Top, Overlapping

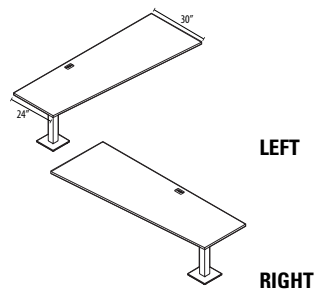

Wedge Shaped Overlapping Conference Top

MODEL#	DIMENSIONS D x W x H	FREIGHT CLASS	WT/LBS.	CUBIC FT.	LIST PRICE	HP ADD
PN3090COL	47 x 90 x 29	150	174	32	\$1036	\$110
PN3096COL	47 x 96 x 29	100	58.50	6.50	\$1047	\$116

PN3090COR	47 x 90 x 29	150	174	32	\$1036	\$110
PN3096COR	47 x 96 x 29	100	58.50	6.50	\$1047	\$116

Specify PNxxxxCOL for **LEFT** or PNxxxxCOR for **RIGHT**.

Standard with square monopost and base. Overlaps **27"H** credenza opening or **27"H** Freestanding Return. Subtop finish is Granite with black edge. Grommet in worksurface. 1" spacer included. Shipped in 2 cartons.

Recommended Maximum Modesty Panel Size:

PN3090COR/COL: 36"W (PN3613DMF)

PN3096COR/COL: 42"W (PN4213DMF)

PN3072DOL	30 x 72 x 29	150	94	19	\$793	\$98
PN3078DOL	30 x 78 x 29	150	101	23	\$808	\$99
PN3084DOL	30 x 84 x 29	92.5	44.50	4	\$868	\$106

PN3072DOR	30 x 72 x 29	150	94	9.50	\$793	\$98
PN3078DOR	30 x 78 x 29	150	101	23	\$808	\$99
PN3084DOR	30 x 84 x 29	92.5	44.50	4	\$868	\$106

Specify PNxxxxDOL for **LEFT** or PNxxxxDOR for **RIGHT**.

Standard with square monopost and base. Overlaps **27"H** credenza opening or **27"H** Freestanding Return. Subtop finish is Granite with black edge. Grommet in worksurface. 1" spacer included. Shipped in 2 cartons.

Recommended Maximum Modesty Panel Size:

PN3072DOR/DOL: 30"W (PN3013DMF)

PN3078DOR/DOL: 30"W (PN3013DMF)

PN3084DOR/DOL: 36"W (PN3613DMF)

PN3072TOL	30 x 72 x 29	150	94	19	\$793	\$108
PN3084TOL	30 x 84 x 29	150	114	23	\$868	\$119

PN3072TOR	30 x 72 x 29	150	94	19	\$793	\$108
PN3084TOR	30 x 84 x 29	150	114	23	\$868	\$119

Specify PNxxxxDOL for **LEFT** or PNxxxxDOR for **RIGHT**.

Standard with square monopost and base. 30"d at overlapping end, 24"d at monopost end. Overlaps **27"H** Credenza opening or **27"H** Freestanding Return. Grommet in worksurface. 1" spacer included. Shipped in 2 cartons.

Recommended Maximum Modesty Panel Size:

PN3072TOR/TOL: 30"W (PN3013DMF)

PN3084TOR/TOL: 36"W (PN3613DMF)

Required Specifications

Top finish
Monopost finish

Optional Specifications

HP laminate
PCSG - custom grommet
RSG - remove grommet

Accessories

Power block
Keyboard tray
Desktop screen
Keyboard tray mounting kit
Wire manager
Keyboard mechanism

CONFERENCE TOPS FOR U CONFIGURATIONS

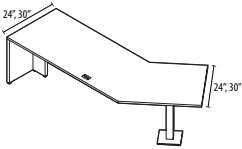

LEFT

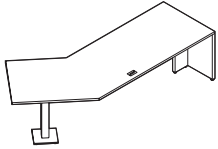

RIGHT

Offset Conference Top, for U Configurations*

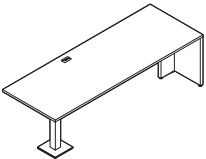

LEFT

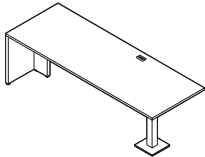

RIGHT

Conference Top for U Configurations*

MODEL#	DIMENSIONS	FREIGHT CLASS	WT/LBS.	CUBIC FT.	LIST PRICE	HP ADD
--------	------------	---------------	---------	-----------	------------	--------

D x W x H						
PN3090CUL	47 x 90 x 29	125	194	32	\$1096	\$150
PN3096CUL	47 x 96 x 29	125	195	32	\$1109	\$151

PN3090CUR	47 x 90 x 29	125	194	32	\$1096	\$150
PN3096CUR	47 x 96 x 29	125	195	32	\$1109	\$151

Specify PNxxxxCUL for **LEFT** or PNxxxxCUR for **RIGHT**.

Standard with T base with square monopost and base. End panel is 1" thick. 1.5" thick support gable extends 12" for end panel. Not freestanding, must be connected. Connects to bridges. Grommet in worksurface. Shipped in 2 cartons.

Recommended Maximum Modesty Panel Size:

PN3090CUR/CUL: 60"W (PN6013DMF)

PN3096CUR/CUL: 66"W (PN6613DMF)

PN3072DUL	30 x 72 x 29	125	114	19	\$932	\$126
PN3084DUL	30 x 84 x 29	150	134	23	\$1095	\$150

PN3072DUR	30 x 72 x 29	125	114	19	\$932	\$126
PN3084DUR	30 x 84 x 29	150	134	23	\$1095	\$150

Specify PNxxxxDUL for **LEFT** or PNxxxxDUR for **RIGHT**.

Standard with T base with square monopost and base. End panel is 1" thick. 1.5" thick support gable extends 12" for end panel. Not freestanding, must be connected. Connects to bridges. Grommet in worksurface. Shipped in 2 cartons.

Recommended Maximum Modesty Panel Size:

PN3072DUR/DUL: 48"W (PN4813DMF)

PN3084DUR/DUL: 60"W (PN6013DMF)

DESKTOP/MODESTY PANELS

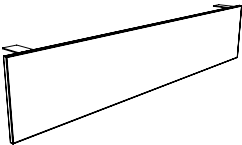

Laminate Modesty Panel

MODEL#	DIMENSIONS	FREIGHT CLASS	WT/LBS.	CUBIC FT.	LIST PRICE
--------	------------	---------------	---------	-----------	------------

PN3013DML	.69 x 30 x 13	85	10	.75	\$304
PN3613DML	.69 x 36 x 13	70	12	.75	\$330
PN4213DML	.69 x 42 x 13	70	14	.75	\$356
PN4813DML	.69 x 48 x 13	70	16	1	\$370
PN5413DML	.69 x 54 x 13	70	18	1	\$416
PN6013DML	.69 x 60 x 13	70	20	1.50	\$487
PN6613DML	.69 x 66 x 13	70	22	1.50	\$502
PN7213DML	.69 x 72 x 13	70	24	1.50	\$518
PN7813DML	.69 x 78 x 13	70	26	1.70	\$608
PN8413DML	.69 x 84 x 13	70	28	1.70	\$754

Attaches to worksurface with black "L" brackets. Laminate modesty panels up to 54"w include two brackets. Panels 60" and wider have three brackets. Specify a nominal size 6" shorter than worksurface size. If using modesty with overlapping worksurface or lower storage, contact Customer Care.

Required Specifications

- Top finish*
- Base finish
- Monopost finish*

Optional Specifications

- HP laminate*
- POG1, POG3 - additional grommet*
- PCSG - custom grommet*
- RSG - remove grommet*

Accessories

- Power block*
- Keyboard tray*
- Desktop screen*
- Keyboard tray mounting kit*
- Wire manager*
- Keyboard mechanism*

DESKTOP AND MODESTY PANELS

Fabric Desktop/Modesty Panel*

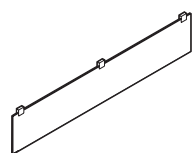

MODEL#	DIMENSIONS D x W x H	FREIGHT CLASS	WT/LBS.	CUBIC FT.	GRADE	LIST PRICE
PN3013DMF	.37 x 30 x 13	250	3	1	1	\$360
					2	\$387
					3	\$407
					4	\$437
PN3613DMF	.37 x 36 x 13	250	3.60	1	1	\$380
					2	\$412
					3	\$437
					4	\$476
PN4213DMF	.37 x 42 x 13	150	4.20	1	1	\$400
					2	\$433
					3	\$459
					4	\$497
PN4813DMF	.37 x 48 x 13	250	4.80	1.50	1	\$409
					2	\$449
					3	\$479
					4	\$525
PN5413DMF	.37 x 54 x 13	250	5.40	1.50	1	\$428
					2	\$472
					3	\$508
					4	\$562
PN6013DMF	.37 x 60 x 13	150	6	1.50	1	\$454
					2	\$499
					3	\$535
					4	\$589
PN6613DMF	.37 x 66 x 13	150	6.60	1.50	1	\$532
					2	\$582
					3	\$625
					4	\$685
PN7213DMF	.37 x 72 x 13	150	7.20	1.75	1	\$567
					2	\$625
					3	\$670
					4	\$739
PN7813DMF	.37 x 78 x 13	150	7.80	1.75	1	\$572
					2	\$636
					3	\$688
					4	\$764

Panels up to 54" w have two clamps. Panels 60" and wider have three clamps. **When used as a modesty panel, specify a nominal size 6" shorter than worksurface size.**

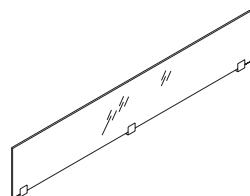

Frosted Glass Desktop Panel

PN3013DG	.25 x 30 x 13	85	10	.75		\$287
PN3613DG	.25 x 36 x 13	70	14	.75		\$301
PN4213DG	.25 x 42 x 13	70	16	.75		\$327
PN4813DG	.25 x 48 x 13	70	20	1		\$340
PN5413DG	.25 x 54 x 13	70	22	1		\$382
PN6013DG	.25 x 60 x 13	70	24	1.50		\$448
PN6613DG	.25 x 66 x 13	70	26	1.50		\$462
PN7213DG	.25 x 72 x 13	70	28	1.50		\$475

Panels up to 54" w have two clamps. Panels 60" and wider have three clamps.

Required Specifications

Fabric*

FELT PANELS **MODEL#** **DIMENSIONS** **FREIGHT CLASS** **WT./LBS.** **CUBIC FT.** **LIST PRICE** **HP ADD**

D x W x H

- 9mm thick panels offered in 9 finishes
- Made from 100% PET (polyester) fiber with a high content (50%) of post-recycled material, free of added chemicals, binders and adhesives
- Lightweight panels are tackable, impact and tear resistant, bacteria resistant, moisture resistant, and installation friendly
- Variation in fiber mix and color are inherent to the character of the product
- Clamps are included. Available in satin anodized finish only.

FELT COLORS

BLK	Black	MTS	Mist
BRI	Brick	PWT	Pewter
DEN	Denim	SHR	Shamrock
GPH	Graphite	WHT	White
HVT	Harvest		

FELT DESKTOP/MODESTY PANELS

MODEL# **DIMENSIONS** **FREIGHT CLASS** **WT./LBS.** **CUBIC FT.** **LIST PRICE**

D x W x H

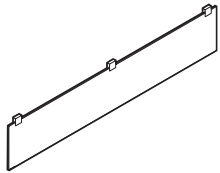

PET Felt Desktop/Modesty Panel, 1 pk.

PN3013PT9-1	.36 x 30 x 12.5	150	2.48	.57	\$147
PN3613PT9-1	.36 x 36 x 12.5	250	2.74	.69	\$155
PN4213PT9-1	.36 x 42 x 12.5	250	2.99	.80	\$211
PN4813PT9-1	.36 x 48 x 12.5	150	3.85	.91	\$219
PN5413PT9-1	.36 x 54 x 12.5	250	4.11	1.03	\$267
PN6013PT9-1	.36 x 60 x 12.5	250	4.36	1.14	\$274
PN6613PT9-1	.36 x 66 x 12.5	150	5.22	1.25	\$330
PN7213PT9-1	.36 x 72 x 12.5	150	5.48	1.36	\$337
PN7813PT9-1	.36 x 78 x 12.5	250	5.73	1.48	\$344

PET Felt Desktop/Modesty Panel available in 9 finishes, please specify. 2, 3 or 4 clamps are included depending on screen size. Clamps available in satin anodized finish only. **When used as a modesty panel, specify a nominal size 6" shorter than worksurface size.**

- Up to 42" w - 2 clamps per panel
- 48"-60" w - 3 clamps per panel
- 66"-78" w - 4 clamps per panel

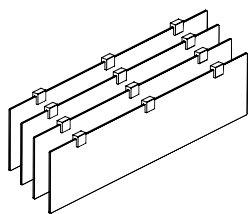

PET Felt Desktop/Modesty Panel, 4 pk.

PN3013PT9-4	0.36 x 30 x 12.5	85	8.93	.60	\$566
PN3613PT9-4	0.36 x 36 x 12.5	85	9.86	.71	\$594
PN4213PT9-4	0.36 x 42 x 12.5	85	10.80	.83	\$813
PN4813PT9-4	0.36 x 48 x 12.5	85	13.90	.98	\$841
PN5413PT9-4	0.36 x 54 x 12.5	85	14.80	1.09	\$1029
PN6013PT9-4	0.36 x 60 x 12.5	85	15.70	1.20	\$1054
PN6613PT9-4	0.36 x 66 x 12.5	85	18.80	1.32	\$1272
PN7213PT9-4	0.36 x 72 x 12.5	85	19.70	1.43	\$1297
PN7813PT9-4	0.36 x 78 x 12.5	85	20.60	1.54	\$1322

PET Felt Desktop/Modesty Panel available in 9 finishes, please specify. 2, 3 or 4 clamps are included depending on screen size. Clamps available in satin anodized finish only. **When used as a modesty panel, specify a nominal size 6" shorter than worksurface size.**

- Up to 42" w - 2 clamps per panel
- 48"-60" w - 3 clamps per panel
- 66"-78" w - 4 clamps per panel

Required Specifications

Felt color

FELT DESKTOP/MODESTY PANELS

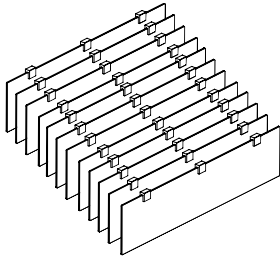

PET Felt Desktop/Modesty Panel, 12 pk.

MODEL#	DIMENSIONS	FREIGHT CLASS	WT/LBS.	CUBIC FT.	LIST PRICE
--------	------------	---------------	---------	-----------	------------

	D x W x H				
PN3013PT9-12	0.36 x 30 x 12.5	85	25.30	1.92	\$1665
PN3613PT9-12	0.36 x 36 x 12.5	85	27.90	2.26	\$1745
PN4213PT9-12	0.36 x 42 x 12.5	92.5	30.50	2.60	\$2393
PN4813PT9-12	0.36 x 48 x 12.5	85	39.30	3.05	\$2470
PN5413PT9-12	0.36 x 54 x 12.5	85	41.90	3.39	\$3031
PN6013PT9-12	0.36 x 60 x 12.5	92.5	44.50	3.72	\$3099
PN6613PT9-12	0.36 x 66 x 12.5	85	53.20	4.18	\$3748
PN7213PT9-12	0.36 x 72 x 12.5	85	55.90	4.51	\$3816
PN7813PT9-12	0.36 x 78 x 12.5	85	58.50	4.85	\$3885

PET Felt Desktop/Modesty Panel available in 9 finishes, please specify. 2, 3 or 4 clamps are included depending on screen size. Clamps available in satin anodized finish only. **When used as a modesty panel, specify a nominal size 6" shorter than worksurface size.**

- Up to 42"w - 2 clamps per panel
- 48"-60"w - 3 clamps per panel
- 66"-78"w - 4 clamps per panel

Required Specifications

Felt color

29" H CREDENZAS

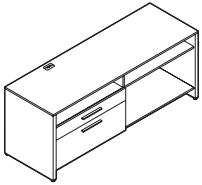

29" H Credenza - LEFT

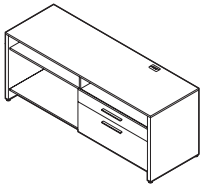

29" H Credenza - RIGHT

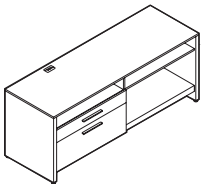

29" H Credenza w/Pull-Out Equipment Tray - LEFT

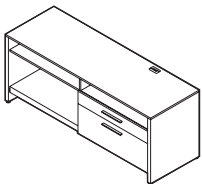

29" H Credenza w/Pull-Out Equipment Tray - RIGHT

MODEL#	DIMENSIONS	FREIGHT CLASS	WT/LBS.	CUBIC FT.	LIST PRICE	HP ADD
--------	------------	---------------	---------	-----------	------------	--------

D x W x H

PN2984CRL	24 x 84 x 29	100	320	33.83	\$1552	\$180
PN2972CRL	24 x 72 x 29	92.5	290	29	\$1471	\$176
PN2966CRL	24 x 66 x 29	100	265	31	\$1455	\$178
PN2960CRL	24 x 60 x 29	92.5	242	24.17	\$1433	\$166

Standard with locking 34"W box and lateral file drawer on **left**. File bars included for front-to-back letter and legal filing capability. Lock on file drawer secures both drawers. Adjustable 5 position shelf. Wire management grommet on surface and internal pass-through behind equipment shelf. Connects to flush returns, flush bridges and flush conference tops. Shipped Fully Assembled.

PN2984CRR	24 x 84 x 29	100	320	33.83	\$1552	\$180
PN2972CRR	24 x 72 x 29	92.5	290	29	\$1471	\$176
PN2966CRR	24 x 66 x 29	100	265	31	\$1455	\$178
PN2960CRR	24 x 60 x 29	92.5	242	24.17	\$1433	\$166

Standard with locking 34"W box and lateral file drawer on **right**. File bars included for front-to-back letter and legal filing capability. Lock on file drawer secures both drawers. Adjustable 5 position shelf. Wire management grommet on surface and internal pass-through behind equipment shelf. Connects to flush returns, flush bridges and flush conference tops. Shipped Fully Assembled.

PN2984CPL	24 x 84 x 29	100	320	33.83	\$1753	\$189
PN2978CPL	24 x 78 x 29	100	310	36	\$1705	\$192
PN2972CPL	24 x 72 x 29	92.5	290	29	\$1663	\$187
PN2966CPL	24 x 66 x 29	100	270	31	\$1600	\$188
PN2960CPL	24 x 60 x 29	92.5	242	24.17	\$1559	\$171

Standard with locking 34"W box and lateral file drawer on **left**. File bars included for front-to-back letter and legal filing capability. Lock on file drawer secures both drawers. Adjustable 5 position shelf. Pull-out equipment shelf can support up to 80lbs. Wire management grommet on surface and internal pass-through behind equipment shelf. Connects to flush returns, flush bridges and flush conference tops. Shipped Fully Assembled.

PN2984CPR	24 x 84 x 29	100	320	33.83	\$1753	\$189
PN2978CPR	24 x 78 x 29	100	310	36	\$1705	\$192
PN2972CPR	24 x 72 x 29	92.5	290	29	\$1663	\$187
PN2966CPR	24 x 66 x 29	100	270	31	\$1600	\$188
PN2960CPR	24 x 60 x 29	92.5	242	24.17	\$1559	\$171

Standard with locking 34"W box and lateral file drawer on **right**. File bars included for front-to-back letter and legal filing capability. Lock on file drawer secures both drawers. Adjustable 5 position shelf. Pull-out equipment shelf can support up to 80lbs. Wire management grommet on surface and internal pass-through behind equipment shelf. Connects to flush returns, flush bridges and flush conference tops. Shipped Fully Assembled.

Required Specifications

Top finish
Base finish
Drawer front finish

Optional Specifications

HP laminate
RSG - remove grommet

29" H CREDENZAS

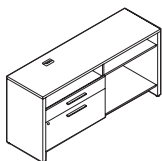

LEFT

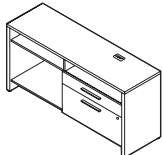

RIGHT

29" H Narrow Credenza*

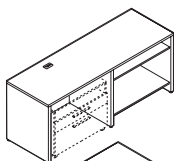

LEFT

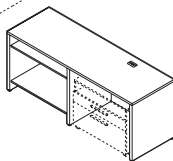

RIGHT

29" H Credenza for Mobile Lateral File

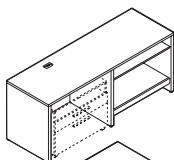

LEFT

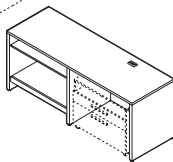

RIGHT

29" H Credenza for Mobile Lateral File w/Pull-Out Equipment Tray*

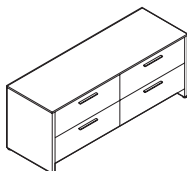

29" H Lateral File Credenza*

MODEL#	DIMENSIONS D x W x H	FREIGHT CLASS	WT/LBS.	CUBIC FT.	LIST PRICE	HP ADD
PN2954NCL	20 x 54 x 29	92.5	250	22	\$1418	\$193
PN2960NCL	20 x 60 x 29	92.5	260	24	\$1436	\$195

PN2954NCR	20 x 54 x 29	92.5	250	22	\$1418	\$193
PN2960NCR	20 x 60 x 29	92.5	260	24	\$1436	\$195

Specify PNxxxxNCL for **LEFT** or PNxxxxNCR for **RIGHT**.

20"D. Standard with 30"W box and lateral file drawer. Front-to-back letter and legal filing capability. Lock on file drawer secures both drawers. Adjustable 5 position shelf. Wire management grommet on surface and internal pass-through behind lower shelf. Connects to flush returns, flush bridges and flush conference tops. File bars included. Shipped Fully Assembled.

PN2972MCL	24 x 72 x 29	125	252	34	\$1159	\$158
PN2984MCL	24 x 84 x 29	125	268	39.50	\$1251	\$170

PN2972MCR	24 x 72 x 29	125	252	34	\$1159	\$158
PN2984MCR	24 x 84 x 29	125	268	39	\$1251	\$170

Specify PNxxxxMCL for **LEFT** or PNxxxxMCR for **RIGHT**.

Standard with 42" w space for lateral file. Adjustable 5 position shelf. Wire management grommet on surface and internal pass-through behind lower shelf. Connects to flush returns, flush bridges and flush conference tops. Accepts all mobile lateral file units. Shipped Fully Assembled.

PN2972MPL	24 x 72 x 29	125	258	34	\$1327	\$180
PN2984MPL	24 x 84 x 29	125	274	39.50	\$1413	\$192

PN2972MPR	24 x 72 x 29	125	258	34	\$1327	\$180
PN2984MPR	24 x 84 x 29	125	274	39.50	\$1413	\$192

Specify PNxxxxMPL for **LEFT** or PNxxxxMPR for **RIGHT**.

Standard with 42" w space for lateral file, adjustable 5 position shelf, and pull-out equipment shelf that can support up to 80lbs. Grommet in worksurface and internal pass-through behind equipment shelf. Connects to flush returns, flush bridges and flush conference tops. Accepts all mobile lateral file units. Shipped Fully Assembled.

PN2972LF	24 x 72 x 29	92.5	290	29	\$1750	\$224
----------	--------------	------	-----	----	--------	-------

Standard with four lateral file drawers. File bars included for front-to-back letter and legal filing capability. Lock on lower drawer secures both drawers. Anti-tip mechanism. Shipped Fully Assembled.

Required Specifications

Top finish
Base finish
Drawer front finish*

Optional Specifications

HP laminate
RSG - remove grommet
Grommet (PN2972LF)

29" H CREDENZAS

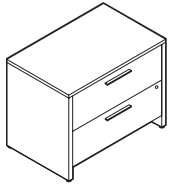

29" H Single Lateral File Credenza*

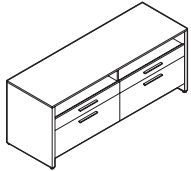

29" H Double Credenza*

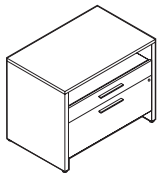

29" H Single Credenza*

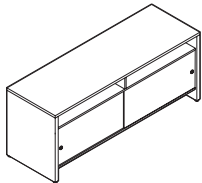

29" H Credenza w/Sliding Laminate Doors*

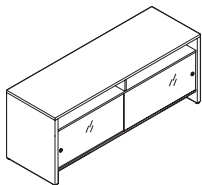

29" H Credenza w/Sliding Glass Doors

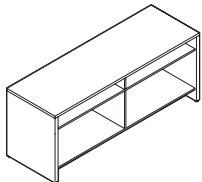

29" H Open Credenza

MODEL#	DIMENSIONS	FREIGHT CLASS	WT/LBS.	CUBIC FT.	LIST PRICE	HP ADD
--------	------------	---------------	---------	-----------	------------	--------

D x W x H

PN2937LFS	24 x 37 x 29	100	155	18	\$1186	\$161
-----------	--------------	-----	-----	----	---------------	--------------

Standard with two lateral file drawers. File bars included for front-to-back letter and legal filing capability. Lock on lower drawer secures both drawers. Anti-tip mechanism. Shipped Fully Assembled.

PN2972CRD	24 x 72 x 29	92.5	290	29	\$1684	\$209
-----------	--------------	------	-----	----	---------------	--------------

Standard with 34" w box and lateral file drawer on each side. File bars included for front-to-back letter and legal filing capability. Lock on file drawer secures both drawers. Shipped Fully Assembled.

PN2937CRS	24 x 37 x 29	100	145	18	\$1186	\$161
-----------	--------------	-----	-----	----	---------------	--------------

Standard with 34" w box and lateral file drawer. File bars included for front-to-back letter and legal filing capability. Lock on file drawer secures both drawers. Shipped Fully Assembled.

PN2960CLS	24 x 60 x 29	100	265	28.25	\$1373	\$187
PN2972CLS	24 x 72 x 29	100	289	34	\$1439	\$195
PN2984CLS	24 x 84 x 29	100	337	39.50	\$1571	\$213

Standard with sliding laminate doors in upper plastic track. Recessed brushed aluminum finger pulls. No lock. Shipped Fully Assembled.

PN2960CGS	24 x 60 x 29	100	265	28.25	\$1733	\$235
PN2972CGS	24 x 72 x 29	100	289	34	\$1917	\$260
PN2984CGS	24 x 84 x 29	100	337	39.50	\$2119	\$287

Standard with sliding glass doors in upper aluminum track. Satin etched 6mm glass. Brushed aluminum finger pulls. No lock. Shipped Fully Assembled.

PN2960CO	24 x 60 x 29	92.5	296	28.25	\$1155	\$157
PN2972CO	24 x 72 x 29	100	316	34	\$1223	\$167
PN2984CO	24 x 84 x 29	100	336	39.50	\$1357	\$185

Open storage with adjustable 5 position upper shelves with pass-throughs at back of lower shelves. Connects to flush returns, flush bridges and flush conference tops. Shipped Fully Assembled.

Required Specifications

Top finish
Base finish
Drawer front finish*

Optional Specifications

HP laminate
Grommet

29"H CREDENZAS

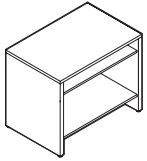

29"H Single Open Credenza**

MODEL#	DIMENSIONS	FREIGHT CLASS	WT./LBS.	CUBIC FT.	LIST PRICE	HP ADD
	D x W x H					
PN2930CO	24 x 30 x 29	92.5	153	15	\$742	\$101
PN2936CO	24 x 36 x 29	100	158	18	\$776	\$106

Open storage with adjustable 5 position upper shelf with pass-through at back of lower shelf. Connects to flush returns, flush bridges and flush conference tops. Shipped Fully Assembled.

27"H CREDENZAS

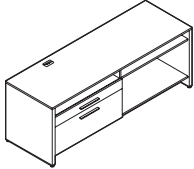

27"H Credenza - LEFT *

MODEL#	DIMENSIONS	FREIGHT CLASS	WT./LBS.	CUBIC FT.	LIST PRICE	HP ADD
PN2760CRL	24 x 60 x 27	92.5	241	22.50	\$1419	\$160
PN2766CRL	24 x 66 x 27	100	262	29	\$1441	\$169
PN2772CRL	24 x 72 x 27	92.5	290	27	\$1455	\$169
PN2778CRL	24 x 78 x 27	100	290	34	\$1500	\$177
PN2784CRL	24 x 84 x 27	92.5	335	31.50	\$1537	\$175

Standard with locking 34"W box and lateral file drawer on **left**. File bars included for front-to-back letter and legal filing capability. Lock on file drawer secures both drawers. Adjustable 5 position shelf. Wire management grommet on surface and internal pass-through behind equipment shelf. Supports overlapping returns, bridges, and conference tops that have a 1" spacer (example: PN24600MR). Cannot nest under 29"H products with metal legs. Shipped Fully Assembled.

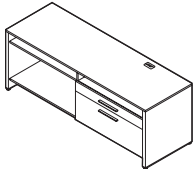

27"H Credenza - RIGHT *

PN2760CRR	24 x 60 x 27	92.5	241	22.50	\$1419	\$160
PN2766CRR	24 x 66 x 27	100	262	29	\$1441	\$169
PN2772CRR	24 x 72 x 27	92.5	290	27	\$1455	\$169
PN2778CRR	24 x 78 x 27	100	290	34	\$1500	\$177
PN2784CRR	24 x 84 x 27	92.5	335	31.50	\$1537	\$175

Standard with locking 34"W box and lateral file drawer on **right**. File bars included for front-to-back letter and legal filing capability. Lock on file drawer secures both drawers. Adjustable 5 position shelf. Wire management grommet on surface and internal pass-through behind equipment shelf. Supports overlapping returns, bridges, and conference tops that have a 1" spacer (example: PN24600MR). Cannot nest under 29"H products with metal legs. Shipped Fully Assembled.

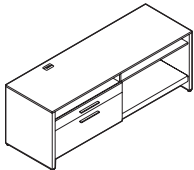

27"H Credenza w/Pull-Out Equipment Tray - LEFT*

PN2760CPL	24 x 60 x 27	92.5	241	22.50	\$1544	\$167
PN2766CPL	24 x 66 x 27	100	267	29	\$1587	\$179
PN2772CPL	24 x 72 x 27	92.5	290	27	\$1650	\$181
PN2778CPL	24 x 78 x 27	100	300	34	\$1691	\$189
PN2784CPL	24 x 84 x 27	92.5	335	31.50	\$1738	\$190

Standard with locking 34"W box and lateral file drawer on **left**. File bars included for front-to-back letter and legal filing capability. Lock on file drawer secures both drawers. Adjustable 5 position shelf. Pull-out equipment tray can support up to 80 lbs. Wire management grommet on surface and internal pass-through behind equipment shelf. Supports overlapping returns, bridges, and conference tops that have a 1" spacer (example: PN24600MR). Cannot nest under 29"H products with metal legs. Shipped Fully Assembled.

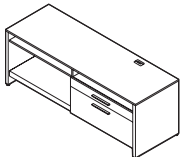

27"H Credenza w/Pull-Out Equipment Tray - RIGHT*

PN2760CPR	24 x 60 x 27	92.5	241	22.50	\$1544	\$167
PN2766CPR	24 x 66 x 27	100	267	29	\$1587	\$179
PN2772CPR	24 x 72 x 27	92.5	290	27	\$1650	\$181
PN2778CPR	24 x 78 x 27	100	300	34	\$1691	\$189
PN2784CPR	24 x 84 x 27	92.5	335	31.50	\$1738	\$190

Standard with locking 34"W box and lateral file drawer on **right**. File bars included for front-to-back letter and legal filing capability. Lock on file drawer secures both drawers. Adjustable 5 position shelf. Pull-out equipment tray can support up to 80 lbs. Wire management grommet on surface and internal pass-through behind equipment shelf. Supports overlapping returns, bridges, and conference tops that have a 1" spacer (example: PN24600MR). Cannot nest under 29"H products with metal legs. Shipped Fully Assembled.

Required Specifications

Top finish
Base finish
Drawer/door front finish*

Optional Specifications

HP laminate
Grommet**
RSG - remove grommet*

27" H CREDENZAS

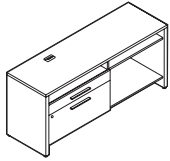

LEFT

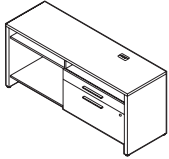

RIGHT

27" H Narrow Credenza*

MODEL#	DIMENSIONS D x W x H	FREIGHT CLASS	WT/LBS.	CUBIC FT.	LIST PRICE	HP ADD
PN2754NCL	20 x 54 x 27	92.5	250	22	\$1380	\$188
PN2760NCL	20 x 60 x 27	92.5	260	24	\$1398	\$190

PN2754NCR	20 x 54 x 27	92.5	250	22	\$1380	\$188
PN2760NCR	20 x 60 x 27	92.5	260	24	\$1398	\$190

Specify PNxxxxNCL for **LEFT** or PNxxxxNCR for **RIGHT**.

20"D. Standard with 30"W box and lateral file drawer. Front-to-back letter and legal filing capability. Lock on file drawer secures both drawers. Adjustable 5 position shelf. Wire management grommet on surface and internal pass-through at back of lower shelf. Supports overlapping returns, bridges, and conference tops that have a 1" spacer (example: PN24600MR). Cannot nest under 29"H products with metal legs. File bars included. Shipped Fully Assembled.

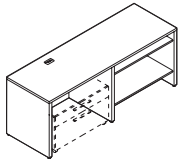

LEFT

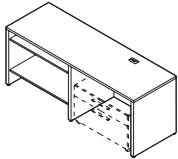

RIGHT

27" H Credenza for Mobile Lateral File

PN2772MCL	24 x 72 x 27	125	252	31.75	\$1145	\$156
PN2784MCL	24 x 84 x 27	125	268	37	\$1236	\$168

PN2772MCR	24 x 72 x 27	125	252	31.75	\$1145	\$156
PN2784MCR	24 x 84 x 27	125	268	37	\$1236	\$168

Specify PNxxxxMCL for **LEFT** or PNxxxxMCR for **RIGHT**.

Standard with 42"W space for lateral file. Adjustable 5 position shelf. Wire management grommet on surface and internal pass-through at back of lower shelf. Supports overlapping returns, bridges, and conference tops that have a 1" spacer (example: PN24600MR). Cannot nest under 29"H products with metal legs. Accepts mobile lateral file units: PN21MLSF and PN22MLBF with and without cushions, and PN25MLSBF without cushions. Shipped Fully Assembled.

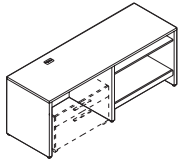

LEFT

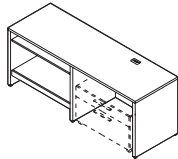

RIGHT

27" H Credenza for Mobile Lateral File w/Pull-Out Equipment Tray

PN2772MPL	24 x 72 x 27	100	258	31.75	\$1314	\$179
PN2784MPL	24 x 84 x 27	125	274	37	\$1398	\$190

PN2772MPR	24 x 72 x 27	100	258	31.75	\$1314	\$179
PN2784MPR	24 x 84 x 27	125	274	37	\$1398	\$190

Specify PNxxxxMPL for **LEFT** or PNxxxxMPR for **RIGHT**.

Standard with 42"W space for lateral file, adjustable 5 position shelf, and pull-out equipment shelf that can support up to 80lbs. Wire management grommet in surface and internal pass-through at back of pull-out equipment shelf. Supports overlapping returns, bridges, and conference tops that have a 1" spacer (example: PN24600MR). Cannot nest under 29"H products with metal legs. Accepts mobile lateral file units: PN21MLSF and PN22MLBF with and without cushions, and PN25MLSBF without cushions. Shipped Fully Assembled.

Required Specifications

Top finish
Base finish
Drawer/door front finish*

Optional Specifications

HP laminate
RSG - remove grommet

27"H CREDENZAS

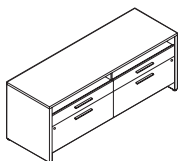

27"H Double Credenza*

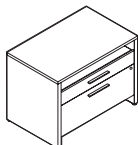

27"H Single Credenza*

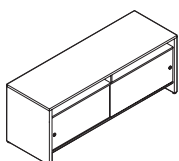

27"H Credenza w/Sliding Laminate Doors*

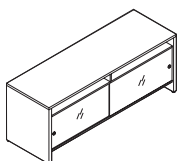

27"H Credenza w/Sliding Glass Doors

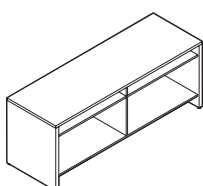

27"H Open Credenza

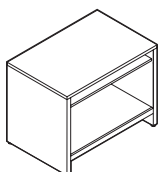

27"H Single Open Credenza

MODEL#	DIMENSIONS	FREIGHT CLASS	WT/LBS.	CUBIC FT.	LIST PRICE	HP ADD
--------	------------	---------------	---------	-----------	------------	--------

D x W x H

PN2772CRD	24 x 72 x 27	100	290	31.75	\$1652	\$209
-----------	--------------	-----	-----	-------	--------	-------

Standard with locking 34"W box and lateral file drawer on each side. File bars included for front-to-back letter and legal filing capability. Lock on file drawer secures both drawers. Shipped Fully Assembled.

PN2737CRS	24 x 37 x 27	100	145	18	\$1153	\$157
-----------	--------------	-----	-----	----	--------	-------

Standard with 34"W box and lateral file drawer. Lock on file drawer secures both drawers. File bars included for front-to-back letter and legal filing capability. Shipped Fully Assembled.

PN2760CLS	24 x 60 x 27	92.5	265	26.50	\$1359	\$185
PN2772CLS	24 x 72 x 27	100	289	31.75	\$1425	\$194
PN2784CLS	24 x 84 x 27	100	337	37	\$1557	\$212

Standard with sliding laminate doors in upper plastic track. Recessed brushed aluminum finger pulls. No lock. Shipped Fully Assembled.

PN2760CGS	24 x 60 x 27	92.5	265	26.50	\$1718	\$233
PN2772CGS	24 x 72 x 27	100	289	31.75	\$1911	\$260
PN2784CGS	24 x 84 x 27	100	337	37	\$2104	\$285

Standard with sliding glass doors in upper aluminum track. Satin etched 6mm glass. Brushed aluminum finger pulls. No lock. Shipped Fully Assembled.

PN2760CO	24 x 60 x 27	92.5	296	26.50	\$1155	\$157
PN2772CO	24 x 72 x 27	100	316	31.75	\$1223	\$167
PN2784CO	24 x 84 x 27	100	336	37	\$1357	\$185

Open storage with adjustable 5 position upper shelves with pass-throughs at back of lower shelves. Supports overlapping returns, bridges, and conference tops that have a 1" spacer (example: PN2460OMR). Cannot nest under 29"H products with metal legs. Shipped Fully Assembled.

PN2730CO	24 x 30 x 27	92.5	153	14	\$728	\$99
PN2736CO	24 x 36 x 27	100	158	16	\$762	\$105

Open storage with adjustable 5 position upper shelf with pass-through at back of lower shelf. Supports overlapping returns, bridges, and conference tops that have a 1" spacer (example: PN2460OMR). Cannot nest under 29"H products with metal legs. Shipped Fully Assembled.

Required Specifications

Top finish
Base finish
Drawer/door front finish*

Optional Specifications

HP laminate
Grommet

23" H CREDENZAS

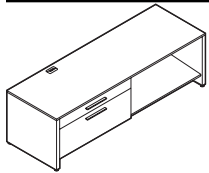

LEFT

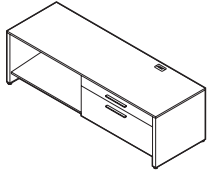

RIGHT

23" H Credenza*

MODEL#	DIMENSIONS D x W x H	FREIGHT CLASS	WT./LBS.	CUBIC FT.	LIST PRICE	HP ADD
PN2360CRL	24 x 60 x 23	100	190	19.17	\$1183	\$148
PN2366CRL	24 x 66 x 23	100	227	25	\$1210	\$155
PN2372CRL	24 x 72 x 23	100	228	23	\$1229	\$153
PN2378CRL	24 x 78 x 23	100	248	30	\$1256	\$159
PN2384CRL	24 x 84 x 23	100	266	26.83	\$1281	\$159

PN2360CRR	24 x 60 x 23	100	190	19.17	\$1183	\$148
PN2366CRR	24 x 66 x 23	100	227	25	\$1210	\$155
PN2372CRR	24 x 72 x 23	100	228	23	\$1229	\$153
PN2378CRR	24 x 78 x 23	100	248	30	\$1256	\$159
PN2384CRR	24 x 84 x 23	100	266	26.83	\$1281	\$159

Standard with 34"W box and lateral file drawer. File bars included for front-to-back letter and legal filing capability. Lock on file drawer secures both drawers. Wire management grommet on surface and internal pass-through at back of lower shelf. Supports Overlapping Return with metal leg and spacer for 23"H credenza, Overlapping Wedge Shaped Return with metal leg and spacer for 23"H credenza, and Overlapping Bridges with metal spacer for 23"H credenza. Shipped Fully Assembled.

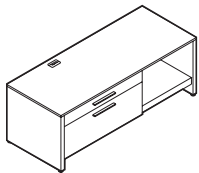

LEFT

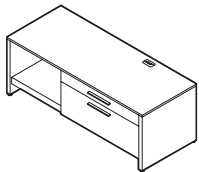

RIGHT

23" H Credenza w/Pull-Out Equipment Tray - RIGHT*

PN2360CPL	24 x 60 x 23	100	190	19.17	\$1342	\$156
PN2366CPL	24 x 66 x 23	100	233	25	\$1386	\$164
PN2372CPL	24 x 72 x 23	100	228	23	\$1431	\$162
PN2378CPL	24 x 78 x 23	100	254	30	\$1464	\$169
PN2384CPL	24 x 84 x 23	100	266	26.83	\$1491	\$169

PN2360CPR	24 x 60 x 23	100	190	19.17	\$1342	\$156
PN2366CPR	24 x 66 x 23	100	233	25	\$1386	\$164
PN2372CPR	24 x 72 x 23	100	228	23	\$1431	\$162
PN2378CPR	24 x 78 x 23	100	254	30	\$1464	\$169
PN2384CPR	24 x 84 x 23	100	266	26.83	\$1491	\$169

Standard with 34"W box and lateral file drawer. Pull-out equipment shelf can support up to 80lbs. Adjustable 5 position shelf. File bars included for front-to-back letter and legal filing capability. Lock on file drawer secures both drawers. Wire management grommet on surface and internal pass-through at back of lower shelf. Supports Overlapping Return with metal leg and spacer for 23"H credenza, Overlapping Wedge Shaped Return with metal leg and spacer for 23"H credenza, and Overlapping Bridges with metal spacer for 23"H credenza. Shipped Fully Assembled.

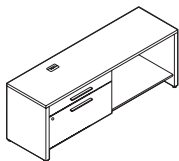

LEFT

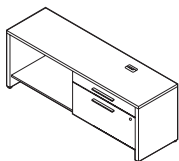

RIGHT

23" H Narrow Credenza

PN2354NCL	20 x 54 x 23	92.5	230	21	\$1157	\$157
PN2360NCL	20 x 60 x 23	92.5	240	23	\$1163	\$158

PN2354NCR	20 x 54 x 23	92.5	230	21	\$1157	\$157
PN2360NCR	20 x 60 x 23	92.5	240	23	\$1163	\$158

Specify PNxxxxNCL for **LEFT** or PNxxxxNCR for **RIGHT**.

20"D. Standard with 30"W box and lateral file drawer. File bars included for front-to-back letter and legal filing capability. Lock on file drawer secures both drawers. Wire management grommet on surface and internal pass-through at back of lower shelf. Supports Overlapping Return with metal leg and spacer for 23"H credenza, Overlapping Wedge Shaped Return with metal leg and spacer for 23"H credenza, and Overlapping Bridges with metal spacer for 23"H credenza. Shipped Fully Assembled.

Required Specifications

Top finish
Base finish
Drawer front finish

Optional Specifications

HP laminate
RSG - remove grommet

Accessories

Cushion

23"H CREDENZAS

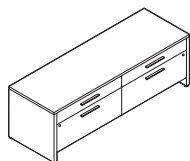

23"H Double Credenza*

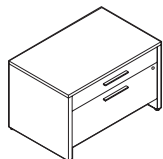

23"H Single Credenza*

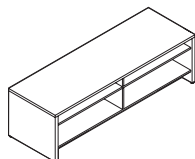

23"H Open Credenza

MODEL#	DIMENSIONS	FREIGHT CLASS	WT/LBS.	CUBIC FT.	LIST PRICE	HP ADD
--------	------------	---------------	---------	-----------	------------	--------

D x W x H

PN2372CRD	24 x 72 x 23	92.5	275	27	\$1524	\$208
-----------	--------------	------	-----	----	---------------	--------------

Standard with locking 34"W box and lateral file drawer on each side. File bars included for front-to-back letter and legal filing capability. Lock on file drawer secures both drawers. Shipped Fully Assembled.

PN2337CRS	24 x 37 x 23	100	125	15	\$1036	\$141
-----------	--------------	-----	-----	----	---------------	--------------

Standard with 34" w box and lateral file drawer. File bars included for front-to-back letter and legal filing capability. Lock on file drawer secures both drawers. Shipped Fully Assembled.

PN2360CO	24 x 60 x 23	85	276	23	\$1019	\$139
PN2372CO	24 x 72 x 23	92.5	296	27.50	\$1106	\$151
PN2384CO	24 x 84 x 23	100	316	32	\$1231	\$168

Open storage with adjustable 5 position upper shelves with pass-throughs at back of lower shelves. Supports Overlapping Return with metal leg and spacer for 23"H credenza, Overlapping Wedge Shaped Return with metal leg and spacer for 23"H credenza, and Overlapping Bridges with metal spacer for 23"H credenza. Shipped Fully Assembled.

Required Specifications

Top finish
Base finish
Drawer front finish*

Optional Specifications

HP laminate
Grommet

Accessories

Cushion

CUSHIONS FOR 23"H CREDENZAS

MODEL#	DIMENSIONS	FREIGHT CLASS	WT/LBS.	CUBIC FT.	GRADE	LIST	GRADE	LIST
	D x W x H							
PN2430CU	24 x 30 x 2.5	150	13	2.40	1	\$226	7	\$487
					2	\$265	8	\$595
					3	\$296	9	\$647
					4	\$341	10	\$749
					5	\$406	11	\$885
					6	\$430	12	\$1057
PN2433CU	24 x 33 x 2.5	150	13	2.40	1	\$247	7	\$594
					2	\$298	8	\$739
					3	\$339	9	\$809
					4	\$400	10	\$943
					5	\$487	11	\$1126
					6	\$519	12	\$1355
PN2436CU	24 x 36 x 2.5	250	7	2	1	\$262	7	\$652
					2	\$320	8	\$815
					3	\$366	9	\$895
					4	\$434	10	\$1046
					5	\$533	11	\$1251
					6	\$568	12	\$1507
PN2439CU	24 x 39 x 2.5	150	14	2.40	1	\$280	7	\$670
					2	\$337	8	\$833
					3	\$383	9	\$912
					4	\$452	10	\$1063
					5	\$551	11	\$1268
					6	\$586	12	\$1525
PN2442CU	24 x 42 x 2.5	150	14	2.40	1	\$293	7	\$683
					2	\$351	8	\$846
					3	\$396	9	\$924
					4	\$465	10	\$1077
					5	\$563	11	\$1282
					6	\$598	12	\$1538

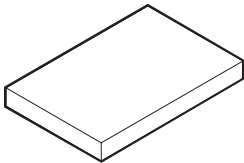

Cushion for 23"H Credenzas

Cushion attaches with Velcro strips. Fits **24"d** credenzas.

PN2027CU	20 x 27 x 2.5	150	12	2.40	1	\$199	7	\$417
					2	\$232	8	\$507
					3	\$258	9	\$552
					4	\$296	10	\$635
					5	\$351	11	\$750
					6	\$370	12	\$891
PN2030CU	20 x 30 x 2.5	150	12	2.40	1	\$216	7	\$433
					2	\$249	8	\$524
					3	\$273	9	\$568
					4	\$313	10	\$651
					5	\$367	11	\$767
					6	\$387	12	\$908

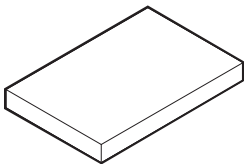

Cushion for 23"H Narrow Credenzas

Cushion attaches with Velcro strips. Fits **20"d** credenzas.

Required Specifications
Fabric

CUSHIONS FOR 23"H CREDENZAS

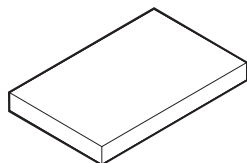

Cushion for 23"H Single Credenza**

MODEL#	DIMENSIONS	FREIGHT CLASS	WT./LBS.	CUBIC FT.	GRADE	LIST	GRADE	LIST
D x W x H								
PN2437CU	24 x 37 x 2.5	150	14	2.40	1	\$277	7	\$667
					2	\$334	8	\$831
					3	\$380	9	\$908
					4	\$449	10	\$1060
					5	\$546	11	\$1265
					6	\$581	12	\$1522

Cushion attaches with Velcro strips. Fits **PN2337CRS** credenza.

52"H STORAGE CABINETS

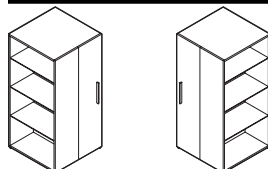

LEFT

RIGHT

52"H Tower Wardrobe w/Full Height Bookcase*

MODEL#	DIMENSIONS	FREIGHT CLASS	WT./LBS.	CUBIC FT.	LIST PRICE
PN52TWBL	24 x 24 x 52	125	129	17.33	\$1357
PN52TWBR	24 x 24 x 52	125	129	17.33	\$1357

Specify PN52TWBL for **LEFT** or PN52TWBR for **RIGHT**.

Locking wardrobe with full height bookcase. Three adjustable laminate shelves with fixed bottom laminate shelf. Coat rail. Shipped Fully Assembled.

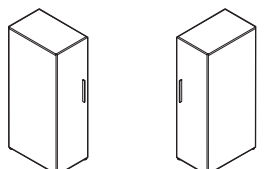

LEFT

RIGHT

52"H Wardrobe*

PN1652WDL	24 x 16 x 52	125	84	11.56	\$807
PN1652WDR	24 x 16 x 52	125	84	11.56	\$807

Specify PN1652WDL for **LEFT** or PN1652WDR for **RIGHT**.

Locking wardrobe with coat rail. Shipped Fully Assembled.

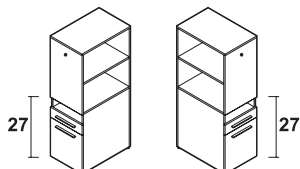

LEFT

RIGHT

52"H Storage Cabinet w/Bookshelf at 27"H*

PN57CSBFL	24 x 16 x 52	100	102	11.56	\$1160
PN57CSBFR	24 x 16 x 52	100	102	11.56	\$1160

Specify PN57CSBFL for **LEFT** or PN57CSBFR for **RIGHT**.

Open Shelf/Box/File Drawer. Lock on file drawer secures both drawers. One adjustable laminate shelf. Fixed bottom shelf aligns with **27"H** surfaces. Outside accessory hook. Shipped Fully Assembled.

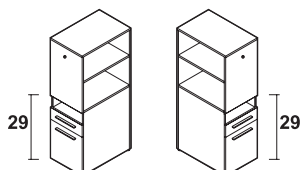

LEFT

RIGHT

52"H Storage Cabinet w/Bookshelf at 29"H

PN59CSBFL	24 x 16 x 52	100	102	11.56	\$1177
PN59CSBFR	24 x 16 x 52	100	102	11.56	\$1177

Specify PN59CSBFL for **LEFT** or PN59CSBFR for **RIGHT**.

Open Shelf/Box/File Drawer. Lock on file drawer secures both drawers. One adjustable laminate shelf. Fixed bottom shelf aligns with **29"H** surfaces. Outside accessory hook. Shipped Fully Assembled.

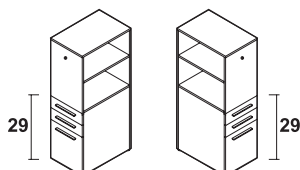

LEFT

RIGHT

52"H Storage Cabinet w/Bookshelf at 29"H

PN59CBBFL	24 x 16 x 52	100	102	11.56	\$1245
PN59CBBFR	24 x 16 x 52	100	102	11.56	\$1245

Specify PN59CBBFL for **LEFT** or PN59CBBFR for **RIGHT**.

Box/Box/File Drawer. Lock on file drawer secures both drawers. One adjustable laminate shelf. Fixed bottom shelf aligns with **29"H** surfaces. Outside accessory hook. Shipped Fully Assembled.

Required Specifications

- Top finish*
- Base finish*
- Drawer/door front finish*
- Fabric**

Optional Specifications

- No lock*

52" H STORAGE CABINETS

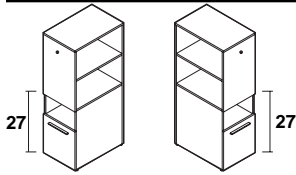

LEFT
52" H Recycling Cabinet
w/Bookshelf at 27" H

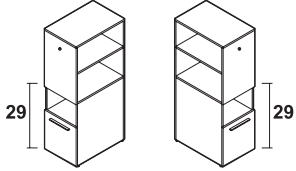

LEFT
52" H Recycling Cabinet
w/Bookshelf at 29" H

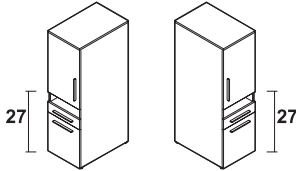

LEFT
52" H Storage Cabinet w/Door at 27" H

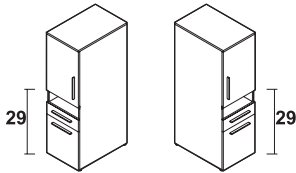

LEFT
52" H Storage Cabinet w/Door at 29" H

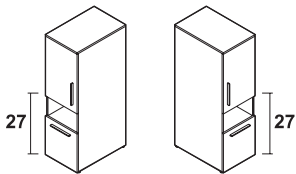

LEFT
52" H Recycling Cabinet w/Door at 27" H

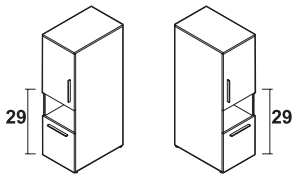

LEFT
52" H Recycling Cabinet w/Door at 29" H

MODEL#	DIMENSIONS D x W x H	FREIGHT CLASS	WT/LBS.	CUBIC FT.	LIST PRICE
PN57RCSL	24 x 16 x 52	100	102	11.56	\$1088
PN57RCSR	24 x 16 x 52	100	102	11.56	\$1088

Specify PN57RCSL for **LEFT** or PN57RCSR for **RIGHT**.

Drawer with one waste bin, one recycling bin and an open shelf above. One adjustable laminate shelf. Fixed bottom shelf aligns with **27" H** surfaces. Outside accessory hook. Shipped Fully Assembled.

PN59RCSL	24 x 16 x 52	100	102	11.56	\$1100
PN59RCSR	24 x 16 x 52	100	102	11.56	\$1100

Specify PN59RCSL for **LEFT** or PN59RCSR for **RIGHT**.

Drawer with one waste bin, one recycling bin and an open shelf above. One adjustable laminate shelf. Fixed bottom shelf aligns with **29" H** surfaces. Outside accessory hook. Shipped Fully Assembled.

PN57DSBFL	24 x 16 x 52	100	102	11.56	\$1277
PN57DSBFR	24 x 16 x 52	100	102	11.56	\$1277

Specify PN57DSBFL for **LEFT** or PN57DSBFR for **RIGHT**.

Open Shelf/Box/File Drawer. Lock on file drawer secures both drawers. Upper storage cabinet with locking door and one adjustable laminate shelf inside. Door aligns with **27" H** surfaces. Shipped Fully Assembled.

PN59DSBFL	24 x 16 x 52	100	102	11.56	\$1301
PN59DSBFR	24 x 16 x 52	100	102	11.56	\$1301

Specify PN59DSBFL for **LEFT** or PN59DSBFR for **RIGHT**.

Open Shelf/Box/File Drawer. Lock on file drawer secures both drawers. Upper storage cabinet with locking door and one adjustable laminate shelf inside. Door aligns with **29" H** surfaces. Shipped Fully Assembled.

PN57DRCSL	24 x 16 x 52	100	102	11.56	\$1130
PN57DRCSR	24 x 16 x 52	100	102	11.56	\$1130

Specify PN57DRCSL for **LEFT** or PN57DRCSR for **RIGHT**.

Upper storage cabinet with locking door. Drawer with one waste bin, one recycling bin, and an open shelf above. One adjustable laminate shelf inside locking cabinet door. Door aligns with **27" H** surfaces. Shipped Fully Assembled.

PN59DRCSL	24 x 16 x 52	100	102	11.56	\$1155
PN59DRCSR	24 x 16 x 52	100	102	11.56	\$1155

Specify PN59DRCSL for **LEFT** or PN59DRCSR for **RIGHT**.

Upper storage cabinet with locking door. Drawer with one waste bin, one recycling bin, and an open shelf above. One adjustable laminate shelf inside locking cabinet door. Door aligns with **29" H** surfaces. Shipped Fully Assembled.

Required Specifications

Top finish
Base finish
Drawer/door front finish

Optional Specifications

No lock (where applicable)

52" H STORAGE CABINETS

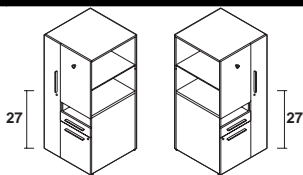

LEFT RIGHT

52" H Storage Tower w/Wardrobe, Shelf and Bookshelf at 27" H

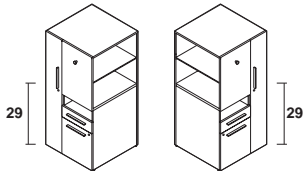

LEFT RIGHT

52" H Storage Tower w/Wardrobe, Shelf and Bookshelf at 29" H

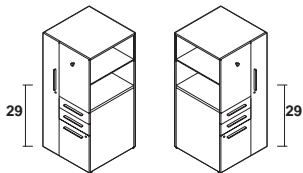

LEFT RIGHT

52" H Storage Tower w/Wardrobe, and Bookshelf at 29" H

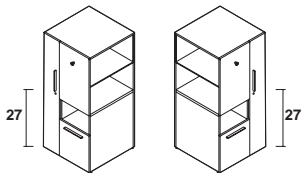

LEFT RIGHT

52" H Storage Tower w/Wardrobe, Shelf, Recycling and Bookshelf at 27" H

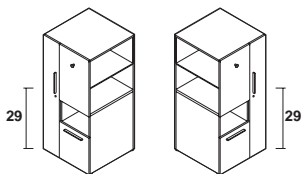

LEFT RIGHT

52" H Storage Tower w/Wardrobe, Shelf, Recycling and Bookshelf at 29" H

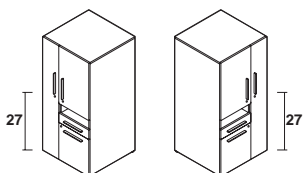

LEFT RIGHT

52" H Storage Tower w/Wardrobe, Shelf/Box/File and Door at 27" H

MODEL#	DIMENSIONS	FREIGHT CLASS	WT/LBS.	CUBIC FT.	LIST PRICE
--------	------------	---------------	---------	-----------	------------

D x W x H

PN57TSBFL	24 x 24 x 52	92.5	225	21	\$1394
PN57TSBFR	24 x 24 x 52	92.5	225	21	\$1394

Specify PN57TSBFL for **LEFT** or PN57TSBFR for **RIGHT**.

Open Shelf/Box/File drawer. Lock on file drawer secures both drawers. One adjustable laminate shelf. Fixed bottom shelf aligns with **27" H** surfaces. Outside accessory hook and locking wardrobe with coat rail. Shipped Fully Assembled.

PN59TSBFL	24 x 24 x 52	92.5	225	21	\$1180
PN59TSBFR	24 x 24 x 52	92.5	225	21	\$1180

Specify PN59TSBFL for **LEFT** or PN59TSBFR for **RIGHT**.

Open Shelf/Box/File drawer. Lock on file drawer secures both drawers. One adjustable laminate shelf. Fixed bottom shelf aligns with **29" H** surfaces. Outside accessory hook and locking wardrobe with coat rail. Shipped Fully Assembled.

PN59TBBFL	24 x 24 x 52	92.5	250	21	\$1611
PN59TBBFR	24 x 24 x 52	92.5	250	21	\$1611

Specify PN59TBBFL for **LEFT** or PN59TBBFR for **RIGHT**.

Box/Box/File drawer. Lock on file drawer secures file and lower box drawer. One adjustable laminate shelf. Fixed bottom shelf aligns with **29" H** surfaces. Outside accessory hook and locking wardrobe with coat rail. Shipped Fully Assembled.

PN57RTSL	24 x 24 x 52	92.5	238	21	\$1497
PN57RTSR	24 x 24 x 52	92.5	238	21	\$1497

Specify PN57RTSL for **LEFT** or PN57RTSR for **RIGHT**.

Drawer with one waste and one recycling bin. Open shelf above. One adjustable laminate shelf. Fixed bottom shelf aligns with **27" H** surfaces. Outside accessory hook. Locking wardrobe with coat rail. Shipped Fully Assembled.

PN59RTSL	24 x 24 x 52	92.5	238	21	\$1497
PN59RTSR	24 x 24 x 52	92.5	238	21	\$1497

Specify PN59RTSL for **LEFT** or PN59RTSR for **RIGHT**.

Drawer with one waste and one recycling bin. Open shelf above. One adjustable laminate shelf. Fixed bottom shelf aligns with **29" H** surfaces. Outside accessory hook. Locking wardrobe with coat rail. Shipped Fully Assembled.

PN57SBFTL	24 x 24 x 52	92.5	234	21	\$1567
PN57SBFTR	24 x 24 x 52	92.5	234	21	\$1567

Specify PN57SBFTL for **LEFT** or PN57SBFTR for **RIGHT**.

Open Shelf/Box/File drawer. Lock on file drawer secures both drawers. Upper storage cabinet with locking door and one adjustable laminate shelf inside. Door aligns with **27" H** surfaces. Locking wardrobe with coat rail. Shipped Fully Assembled.

Required Specifications

Top finish
Base finish
Drawer/door front finish

Optional Specifications

No lock

52" H STORAGE CABINETS

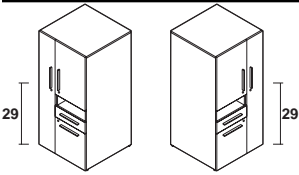

LEFT RIGHT
52" H Storage Tower w/Wardrobe, Shelf/Box/File and Door at 29" H

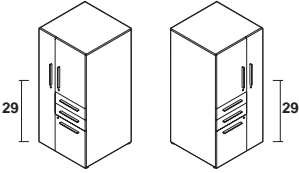

LEFT RIGHT
52" H Storage Tower w/Wardrobe, Shelf, Box/Box/File and Door at 29" H

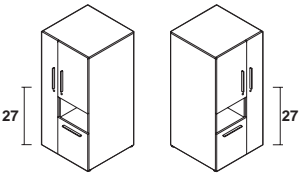

LEFT RIGHT
52" H Storage Tower w/Wardrobe, Shelf, Recycling and Door at 27" H

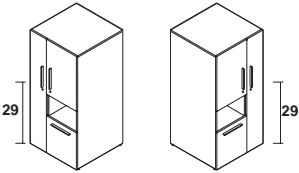

LEFT RIGHT
52" H Storage Tower w/Wardrobe, Shelf, Recycling and Door at 29" H

MODEL#	DIMENSIONS D x W x H	FREIGHT CLASS	WT/LBS.	CUBIC FT.	LIST PRICE
PN59SBFTL	24 x 24 x 52	92.5	234	21	\$1567
PN59SBFTR	24 x 24 x 52	92.5	234	21	\$1567

Specify PN59SBFTL for **LEFT** or PN59SBFTR for **RIGHT**.

Open Shelf/Box/File drawer. Lock on file drawer secures both drawers. Upper storage cabinet with locking door and one adjustable laminate shelf inside. Door aligns with **29" H** surfaces. Locking wardrobe with coat rail. Shipped Fully Assembled.

PN59BBFTL	24 x 24 x 52	92.5	234	21	\$1653
PN59BBFTR	24 x 24 x 52	92.5	234	21	\$1653

Specify PN59BBFTL for **LEFT** or PN59BBFTR for **RIGHT**.

Box/Box/File drawer. Lock on file drawer secures file and lower box drawers. Upper storage cabinet with locking door and one adjustable laminate shelf inside. Door aligns with **29" H** surfaces. Locking wardrobe with coat rail. Shipped Fully Assembled.

PN57DRTSL	24 x 24 x 52	92.5	234	21	\$1595
PN57DRTSR	24 x 24 x 52	92.5	234	21	\$1595

Specify PN57DRTSL for **LEFT** or PN57DRTSR for **RIGHT**.

Drawer with one waste and one recycling bin Open shelf above. Upper storage cabinet with locking door and one adjustable laminate shelf inside. Door aligns with **27" H** surfaces. Locking wardrobe with coat rail. Shipped Fully Assembled.

PN59DRTSL	24 x 24 x 52	92.5	234	21	\$1595
PN59DRTSR	24 x 24 x 52	92.5	234	21	\$1595

Specify PN59DRTSL for **LEFT** or PN59DRTSR for **RIGHT**.

Drawer with one waste and one recycling bin Open shelf above. Upper storage cabinet with locking door and one adjustable laminate shelf inside. Door aligns with **29" H** surfaces. Locking wardrobe with coat rail. Shipped Fully Assembled.

Required Specifications

Top finish
 Base finish
 Drawer/door front finish

Optional Specifications

No lock

66" H STORAGE CABINETS

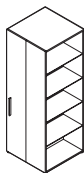
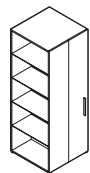

LEFT
66" H Tower Wardrobe w/Full Height Bookcase



LEFT
66" H Wardrobe

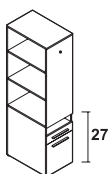
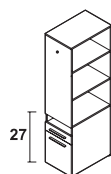

LEFT
66" H Storage Cabinet w/Bookshelf at 27" H

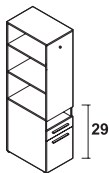
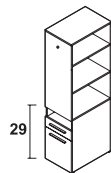

LEFT
66" H Storage Cabinet w/Bookshelf at 29" H

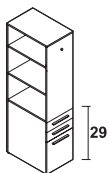
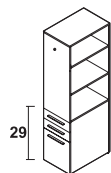

LEFT
66" H Storage Cabinet w/Bookshelf at 29" H

MODEL#	DIMENSIONS	FREIGHT CLASS	WT/LBS.	CUBIC FT.	LIST PRICE
--------	------------	---------------	---------	-----------	------------

D x W x H

PN66TWBL	24 x 24 x 66	125	165	22	\$1574
PN66TWBR	24 x 24 x 66	125	165	22	\$1574

Specify PN66TWBL for **LEFT** or PN66TWBR for **RIGHT**.

Locking wardrobe and full height bookcase. Four adjustable laminate shelves with fixed bottom laminate shelf. Coat rail. Shipped Fully Assembled.

PN1666WDL	24 x 16 x 66	125	106	14.67	\$913
PN1666WDR	24 x 16 x 66	125	106	14.67	\$913

Specify PN1666WDL for **LEFT** or PN1666WDR for **RIGHT**.

Locking wardrobe with coat rail and fixed shelf above. Shipped Fully Assembled.

PN67CSBFL	24 x 16 x 66	100	130	14.67	\$1248
PN67CSBFR	24 x 16 x 66	100	130	14.67	\$1248

Specify PN67CSBFL for **LEFT** or PN67CSBFR for **RIGHT**.

Open Shelf/Box/File Drawer. Lock on file drawer secures both drawers. Two adjustable laminate shelves. Fixed bottom shelf aligns with **27" H** surfaces. Outside accessory hook. Shipped Fully Assembled.

PN69CSBFL	24 x 16 x 66	100	130	14.67	\$1248
PN69CSBFR	24 x 16 x 66	100	130	14.67	\$1248

Specify PN69CSBFL for **LEFT** or PN69CSBFR for **RIGHT**.

Open Shelf/Box/File Drawer. Lock on file drawer secures both drawers. Two adjustable laminate shelves. Fixed bottom shelf aligns with **29" H** surfaces. Outside accessory hook. Shipped Fully Assembled.

PN69CBBFL	24 x 16 x 66	100	130	14.67	\$1334
PN69CBBFR	24 x 16 x 66	100	130	14.67	\$1334

Specify PN69CBBFL for **LEFT** or PN69CBBFR for **RIGHT**.

Box/Box/File Drawer. Lock on file drawer secures file and lower box drawer. Two adjustable laminate shelves. Fixed bottom shelf aligns with **29" H** surfaces. Outside accessory hook. Shipped Fully Assembled.

Required Specifications

Top finish
Base finish
Drawer/door front finish

Optional Specifications

No lock

66" H STORAGE CABINETS

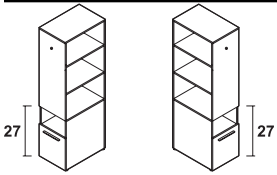

LEFT
RIGHT
66" H Recycling Cabinet
w/Bookshelf at 27" H

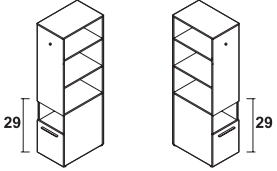

LEFT
RIGHT
66" H Recycling Cabinet
w/Bookshelf at 29" H

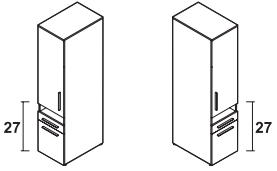

LEFT
RIGHT
66" H Storage Cabinet w/Door at 27" H

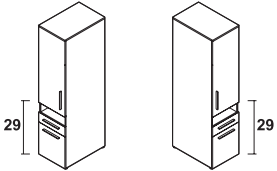

LEFT
RIGHT
66" H Storage Cabinet w/Door at 29" H

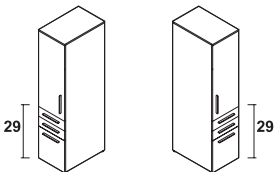

LEFT
RIGHT
66" H Storage Cabinet w/Door at 29" H

MODEL#	DIMENSIONS D x W x H	FREIGHT CLASS	WT/LBS.	CUBIC FT.	LIST PRICE
PN67RCSL	24 x 16 x 66	100	130	14.67	\$1197
PN67RCSR	24 x 16 x 66	100	130	14.67	\$1197

Specify PN67RCSL for **LEFT** or PN67RCSR for **RIGHT**.

Drawer with one waste bin and one recycling bin. Open shelf above. Two adjustable laminate shelves. Fixed bottom shelf aligns with **27" H** surfaces. Outside accessory hook. Shipped Fully Assembled.

PN69RCSL	24 x 16 x 66	100	130	14.67	\$1197
PN69RCSR	24 x 16 x 66	100	130	14.67	\$1197

Specify PN69RCSL for **LEFT** or PN69RCSR for **RIGHT**.

Drawer with one waste bin and one recycling bin. Open shelf above. Two adjustable laminate shelves. Fixed bottom shelf aligns with **29" H** surfaces. Outside accessory hook. Shipped Fully Assembled.

PN67DSBFL	24 x 16 x 66	100	130	14.67	\$1322
PN67DSBFR	24 x 16 x 66	100	130	14.67	\$1322

Specify PN67DSBFL for **LEFT** or PN67DSBFR for **RIGHT**.

Open Shelf/Box/File Drawer. Lock on file drawer secures both drawers. Upper storage cabinet with locking door and two adjustable laminate shelves inside. Door aligns with **27" H** surfaces. Shipped Fully Assembled.

PN69DSBFL	24 x 16 x 66	100	130	14.67	\$1368
PN69DSBFR	24 x 16 x 66	100	130	14.67	\$1368

Specify PN69DSBFL for **LEFT** or PN69DSBFR for **RIGHT**.

Open Shelf/Box/File Drawer. Lock on file drawer secures both drawers. Upper storage cabinet with locking door and two adjustable laminate shelves inside. Door aligns with **29" H** surfaces. Shipped Fully Assembled.

PN69DBBFL	24 x 16 x 66	100	130	14.67	\$1452
PN69DBBFR	24 x 16 x 66	100	130	14.67	\$1452

Specify PN69DBBFL for **LEFT** or PN69DBBFR for **RIGHT**.

Box/Box/File Drawer. Lock on file drawer secures file and lower box drawer. Upper storage cabinet with locking door and two adjustable laminate shelves inside. Door aligns with **29" H** surfaces. Shipped Fully Assembled.

Required Specifications

Top finish
Base finish
Drawer/door front finish

Optional Specifications

No lock (where applicable)

66" H STORAGE CABINETS

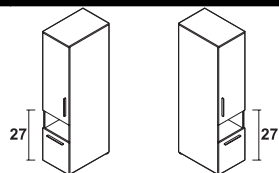

LEFT

RIGHT

66" H Recycling Cabinet w/Door at 27" H

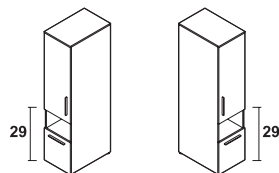

LEFT

RIGHT

66" H Recycling Cabinet w/Door at 29" H

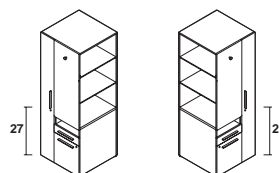

LEFT

RIGHT

66" H Storage Tower w/Wardrobe, Shelf, Box/File and Bookshelf at 27" H

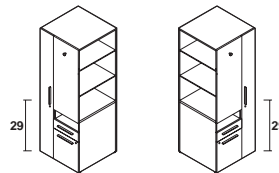

LEFT

RIGHT

66" H Storage Tower w/Wardrobe, Shelf, Box/File and Bookshelf at 29" H

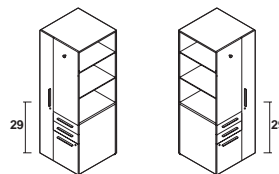

LEFT

RIGHT

66" H Storage Tower w/Wardrobe, Shelf, Box/Box/File and Bookshelf at 29" H

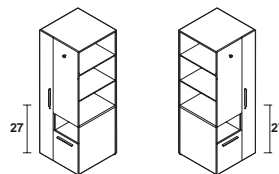

LEFT

RIGHT

66" H Storage Tower w/Wardrobe, Shelf, Recycling and Bookshelf at 27" H

MODEL#	DIMENSIONS	FREIGHT CLASS	WT/LBS.	CUBIC FT.	LIST PRICE
--------	------------	---------------	---------	-----------	------------

D x W x H

PN67DRCSL	24 x 16 x 66	100	130	14.67	\$1242
PN67DRCSR	24 x 16 x 66	100	130	14.67	\$1242

Specify PN67DRCSL for **LEFT** or PN67DRCSR for **RIGHT**.

Upper storage cabinet with locking door and two adjustable laminate shelves inside. Drawer with one waste bin, one recycling bin, and an open shelf above. Door aligns with **27" H** surfaces. Shipped Fully Assembled.

PN69DRCSL	24 x 16 x 66	100	130	14.67	\$1308
PN69DRCSR	24 x 16 x 66	100	130	14.67	\$1308

Specify PN69DRCSL for **LEFT** or PN69DRCSR for **RIGHT**.

Upper storage cabinet with locking door and two adjustable laminate shelves inside. Drawer with one waste bin, one recycling bin, and an open shelf above. Door aligns with **29" H** surfaces. Shipped Fully Assembled.

PN67TSBFL	24 x 24 x 66	92.5	260	26	\$1960
PN67TSBFR	24 x 24 x 66	92.5	260	26	\$1960

Specify PN67TSBFL for **LEFT** or PN67TSBFR for **RIGHT**.

Open Shelf/Box/File drawer. Lock on file drawer secures both drawers. Two adjustable laminate shelves. Fixed bottom shelf aligns with **27" H** surfaces. Outside accessory hook and locking wardrobe with coat rail. Shipped Fully Assembled.

PN69TSBFL	24 x 24 x 66	92.5	260	26	\$1960
PN69TSBFR	24 x 24 x 66	92.5	260	26	\$1960

Specify PN69TSBFL for **LEFT** or PN69TSBFR for **RIGHT**.

Open Shelf/Box/File drawer. Lock on file drawer secures both drawers. Two adjustable laminate shelves. Fixed bottom shelf aligns with **29" H** surfaces. Outside accessory hook and locking wardrobe with coat rail. Shipped Fully Assembled.

PN69TBBFL	24 x 24 x 66	92.5	262	26	\$2064
PN69TBBFR	24 x 24 x 66	92.5	262	26	\$2064

Specify PN69TBBFL for **LEFT** or PN69TBBFR for **RIGHT**.

Box/Box/File drawer. Lock on file and lower box drawer. Two adjustable laminate shelves. Fixed bottom shelf aligns with **29" H** surfaces. Outside accessory hook and locking wardrobe with coat rail. Shipped Fully Assembled.

PN67RTSL	24 x 24 x 66	92.5	260	26	\$1968
PN67RTSR	24 x 24 x 66	92.5	260	26	\$1968

Specify PN67RTSL for **LEFT** or PN67RTSR for **RIGHT**.

Drawer with one waste and one recycling bin. Open shelf above. Two adjustable laminate shelves. Fixed bottom shelf aligns with **27" H** surfaces. Outside accessory hook. Locking wardrobe with coat rail. Shipped Fully Assembled.

Required Specifications

Top finish
Base finish
Drawer/door front finish

Optional Specifications

No lock (where applicable)

66" H STORAGE CABINETS

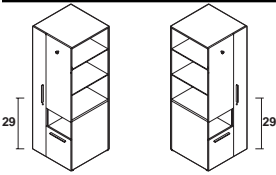

LEFT RIGHT

66" H Storage Tower w/Wardrobe, Shelf, Recycling and Bookshelf at 29" H

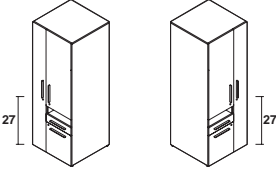

LEFT RIGHT

66" H Storage Tower w/Wardrobe, Shelf, Box/File and Door at 27" H

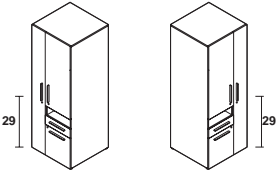

LEFT RIGHT

66" H Storage Tower w/Wardrobe, Shelf, Box/File and Door at 29" H

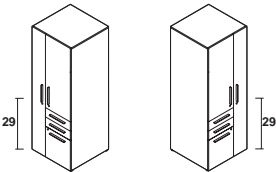

LEFT RIGHT

66" H Storage Tower w/Wardrobe, Box/Box/File and Door at 29" H

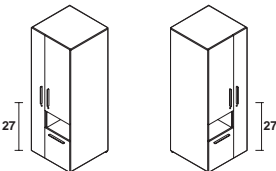

LEFT RIGHT

66" H Storage Tower w/Wardrobe, Large Shelf, Recycling and Door at 27" H

MODEL#	DIMENSIONS D x W x H	FREIGHT CLASS	WT./LBS.	CUBIC FT.	LIST PRICE
PN69RTSL	24 x 24 x 66	92.5	260	26	\$1968
PN69RTSR	24 x 24 x 66	92.5	260	26	\$1968

Specify PN69RTSL for **LEFT** or PN69RTSR for **RIGHT**.

Drawer with one waste and one recycling bin. Open shelf above. Two adjustable laminate shelves. Fixed bottom shelf aligns with **29" H** surfaces. Outside accessory hook. Locking wardrobe with coat rail. Shipped Fully Assembled.

PN67SBFTL	24 x 24 x 66	100	257	26	\$2032
PN67SBFTR	24 x 24 x 66	100	257	26	\$2032

Specify PN67SBFTL for **LEFT** or PN67SBFTR for **RIGHT**.

Open Shelf/Box/File Drawer. Lock on file drawer secures both drawers. Upper storage cabinet with locking door and two adjustable laminate shelves inside. Door aligns with **27" H** surfaces. Outside accessory hook. Locking wardrobe with coat rail. Shipped Fully Assembled.

PN69SBFTL	24 x 24 x 66	100	257	26	\$2032
PN69SBFTR	24 x 24 x 66	100	257	26	\$2032

Specify PN69SBFTL for **LEFT** or PN69SBFTR for **RIGHT**.

Open Shelf/Box/File Drawer. Lock on file drawer secures both drawers. Upper storage cabinet with locking door and two adjustable laminate shelves inside. Door aligns with **29" H** surfaces. Locking wardrobe with coat rail. Shipped Fully Assembled.

PN69BBFTL	24 x 24 x 66	100	257	26	\$2136
PN69BBFTR	24 x 24 x 66	100	257	26	\$2136

Specify PN69BBFTL for **LEFT** or PN69BBFTR for **RIGHT**.

Box/Box/File Drawer. Lock on file drawer secures file and lower box drawer. Upper storage cabinet with locking door and two adjustable laminate shelves inside. Door aligns with **29" H** surfaces. Locking wardrobe with coat rail. Shipped Fully Assembled.

PN67DRTSL	24 x 24 x 66	100	230	26	\$2082
PN67DRTSR	24 x 24 x 66	100	230	26	\$2082

Specify PN67DRTSL for **LEFT** or PN67DRTSR for **RIGHT**.

Drawer with one waste and one recycling bin. Open shelf above. Upper storage cabinet with locking door and two adjustable laminate shelves inside. Door aligns with **27" H** surfaces. Locking wardrobe with coat rail. Shipped Fully Assembled.

Required Specifications

Top finish
Base finish
Drawer/door front finish

Optional Specifications

No lock (where applicable)

66" H STORAGE CABINETS

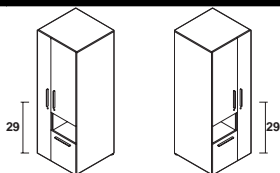

LEFT

RIGHT

66" H Storage Tower w/Wardrobe,
Large Shelf, Recycling and Door at 29" H

MODEL#	DIMENSIONS	FREIGHT CLASS	WT/LBS.	CUBIC FT.	LIST PRICE
	D x W x H				
PN69DRTSL	24 x 24 x 66	100	230	26	\$2082
PN69DRTSR	24 x 24 x 66	100	230	26	\$2082

Specify PN69DRTSL for **LEFT** or PN69DRTSR for **RIGHT**.

Drawer with one waste and one recycling bin. Open shelf above. Upper storage cabinet with locking door and two adjustable laminate shelves inside. Door aligns with 29" H surfaces. Locking wardrobe with coat rail. Shipped Fully Assembled.

MOBILE PEDESTALS

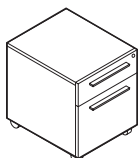

20.5" h Mobile Pedestal

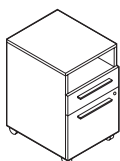

25.5" h Mobile Pedestal



25.5" H Mobile Pedestal



27" H Mobile Pedestal

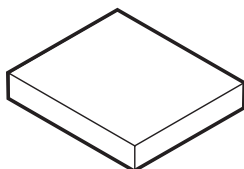

Pedestal Cushion*

MODEL#	DIMENSIONS	FREIGHT CLASS	WT/LBS.	CUBIC FT.	LIST PRICE	HP ADD
PN22MBF	22 x 16 x 20.5	85	79	5.75	\$727	\$75
PN25MSBF	22 x 16 x 25.5	92.5	80	7	\$770	\$81
PN25MBBF	22 x 16 x 25.5	92.5	95	8	\$812	\$97
PN27MFF	22 x 16 x 27	85	101	8	\$795	\$90
PN1622CU	21 x 16 x 2.5	125	6	.90	1 \$140	7 \$314
					2 \$166	8 \$387
					3 \$187	9 \$422
					4 \$217	10 \$488
					5 \$260	11 \$579
					6 \$277	12 \$694

Box/File drawer. Lock on box drawer secures both drawers. Front casters are locking. Shipped Fully Assembled.

Open Shelf/Box/File drawer. Lock on file drawer secures both drawers. Front casters are locking. Shipped Fully Assembled.

Box/Box/File drawer. Lock on file drawer secures file and lower box drawer. Front casters are locking. Shipped Fully Assembled.

File/File. Lock on lower file drawer secures both drawers. Front casters are locking. Shipped Fully Assembled.

- 27" H mobile pedestals can only be used with 29" H Princeton products that have laminate end panels/gables. Princeton products with metal legs will not accommodate 27" H mobile units.

For **PN22MBF** mobile pedestals.

Required Specifications

Top finish
Base finish
Drawer/door front finish
Fabric*

Optional Specifications

No lock (where applicable)
HP laminate

Accessories

Pedestal cushion

MOBILE LATERAL FILES

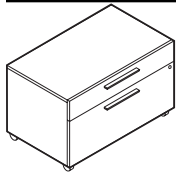

20.5”h Mobile Lateral File*

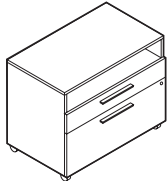

25.5”h Mobile Lateral File

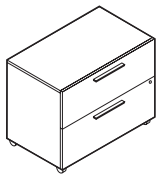

27”H Mobile Lateral File

MODEL#	DIMENSIONS	FREIGHT CLASS	WT/LBS.	CUBIC FT.	LIST PRICE	HP ADD
--------	------------	---------------	---------	-----------	------------	--------

	D x W x H					
PN22MLBF	22 x 35.5 x 20.5	100	132	14	\$1146	\$156

Box/File drawer. Lock on file drawer secures both drawers. File bars included for front-to-back letter and legal filing capability. Front casters are locking. Shipped Fully Assembled. Can fit under 29”H and 27”H credenzas for mobile lateral file with or without a cushion. Can fit under 23”H credenzas without cushion only.

PN25MLSBF	22 x 35.5 x 25.5	100	138	16	\$1199	\$163
-----------	------------------	-----	-----	----	---------------	--------------

Open Shelf/Box/File drawer. Lock on file drawer secures both drawers. File bars included for front-to-back letter and legal filing capability. Front casters are locking. Shipped Fully Assembled. Can fit under 29”H credenzas for mobile lateral file without cushion only.

PN27MLFF	22 x 35.5 x 27	92.5	170	16	\$1251	\$170
----------	----------------	------	-----	----	---------------	--------------

File/File drawer. Lock on bottom file drawer secures both drawers. File bars included for front-to-back letter and legal filing capability. Front casters are locking. Shipped Fully Assembled. Can fit under 29”H credenzas for mobile lateral file without cushion only.

- 27”H mobile pedestals can only be used with 29”H Princeton products that have laminate end panels/gables. Princeton products with metal legs will not accommodate 27”H mobile units.

CUSHIONS FOR MOBILE LATERAL FILE

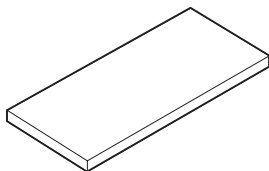

Mobile Lateral File Cushion**

MODEL#	DIMENSIONS	FREIGHT CLASS	WT/LBS.	CUBIC FT.	GRADE	LIST	GRADE	LIST
--------	------------	---------------	---------	-----------	-------	------	-------	------

PN3622CU	21 x 35.5 x 2.5	150	14	2.40	1	\$283	7	\$630
					2	\$334	8	\$775
					3	\$375	9	\$845
					4	\$436	10	\$979
					5	\$523	11	\$1162
					6	\$555	12	\$1391

For **PN21MLSF** and **PN22MLBF** mobile lateral files.

Required Specifications

Fabric**
 Top finish (Mobile Laterals)
 Base finish (Mobile Laterals)
 Door/drawer front finish (Mobile Laterals)

Optional Specifications

No lock (Mobile Laterals)
 HP laminate (Mobile Laterals)

Accessories

Cushion*

STOOLS

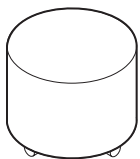

Round Mobile Stool

MODEL#	DIMENSIONS	FREIGHT CLASS	WT/LBS.	CUBIC FT.	LIST PRICE
	D x W x H				
PN1920ST	19 x 19 x 19.5	250	20	5.50	\$471

Laminate base for use with cushion. **CANNOT BE USED WITHOUT CUSHION. Cushion sold separately.** Six casters.
 • **NOTE: Maximum weight capacity is 200 lbs.**

CUSHION FOR MOBILE STOOL



Cushion for Round Mobile Stool*

MODEL#	DIMENSIONS	FREIGHT CLASS	WT/LBS.	CUBIC FT.	GRADE	LIST	GRADE	LIST
SEAT-PN1920ST	--	150	8	1.60	1	\$195	7	\$342
					2	\$217	8	\$394
					3	\$233	9	\$433
					4	\$259	10	\$477
					5	\$294	11	\$568
					6	\$309	12	\$664

To be used with PN1920ST.

PLANTERS

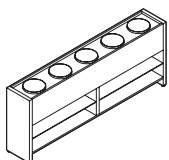

Five Pot Planter**

MODEL#	DIMENSIONS	FREIGHT CLASS	WT/LBS.	CUBIC FT.	LIST PRICE
PN7229PL	12 x 72 x 29	100	124	14.50	\$1060

Five plastic pots - specify Black (BK) or White (WT). Adjustable 3 position laminate shelves. Shipped Fully Assembled.

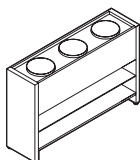

Three Pot Planter**

PN4229PL	12 x 42 x 29	92.5	86	8.46	\$806
----------	--------------	------	----	------	--------------

Three plastic pots - specify Black (BK) or White (WT). Adjustable 3 position laminate shelf. Shipped Fully Assembled.

DIVIDER SHELVES

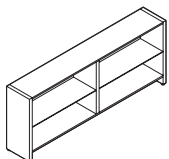

72" w Divider Shelf

MODEL#	DIMENSIONS	FREIGHT CLASS	WT/LBS.	CUBIC FT.	LIST PRICE
PN7229BGS	12 x 72 x 29	125	124	18	\$876

Fixed laminate shelves. Shipped Fully Assembled.

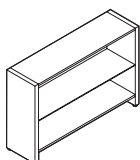

42" w Divider Shelf

PN4229BGS	12 x 42 x 29	125	86	11	\$706
-----------	--------------	-----	----	----	--------------

Fixed laminate shelf. Shipped Fully Assembled.

Required Specifications

- Fabric*
- Planter pot finish**
- Top finish
- Base finish

BOOKSHELVES

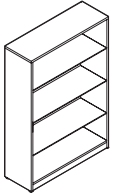

Bookshelf w/Laminate Shelves

MODEL#	DIMENSIONS D x W x H	FREIGHT CLASS	WT./LBS.	CUBIC FT.	LIST PRICE	HP ADD
PN2429BLS	12 x 24 x 29	70	37	2	\$538	\$85
PN2452BLS	12 x 24 x 52	70	60	3	\$682	N/A
PN2466BLS	12 x 24 x 66	70	74	4	\$749	N/A
PN3029BLS	12 x 30 x 29	70	44	2	\$605	\$98
PN3052BLS	12 x 30 x 52	65	68	3	\$707	N/A
PN3066BLS	12 x 30 x 66	70	79	4	\$780	N/A
PN3629BLS	12 x 36 x 29	70	66	3	\$650	\$105
PN3652BLS	12 x 36 x 52	70	80	4	\$745	N/A
PN3666BLS	12 x 36 x 66	70	106	5	\$819	N/A

66"H models have four adjustable shelves. 52"H models have 3 adjustable shelves. 29"H models have 1 adjustable shelf. Shipped Fully Assembled.

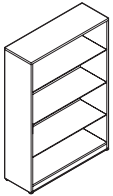

Bookshelf w/Glass Shelves

PN2429BGS	12 x 24 x 29	70	37	2	\$560	\$85
PN2452BGS	12 x 24 x 52	70	60	3	\$831	N/A
PN2466BGS	12 x 24 x 66	70	74	4	\$989	N/A
PN3029BGS	12 x 30 x 29	70	44	2	\$648	\$98
PN3052BGS	12 x 30 x 52	65	68	3	\$895	N/A
PN3066BGS	12 x 30 x 66	70	79	4	\$1033	N/A
PN3629BGS	12 x 36 x 29	70	66	3	\$647	\$105
PN3652BGS	12 x 36 x 52	70	80	4	\$974	N/A
PN3666BGS	12 x 36 x 66	70	106	5	\$1143	N/A

66"H models have four adjustable shelves. 52"H models have 3 adjustable shelves. 29"H models have 1 adjustable shelf. Shipped Fully Assembled.

DESKTOP AND OVERHEAD STORAGE

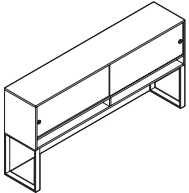

Hutch w/Laminate Doors*

MODEL#	DIMENSIONS	FREIGHT CLASS	WT./LBS.	CUBIC FT.	LIST PRICE
PN3560LCH	16 x 60 x 35	125	131	18	\$1377
PN3572LCH	16 x 72 x 35	125	135	21	\$1424
PN3584LCH	16 x 84 x 35	150	145	25	\$1528

Sliding laminate doors in upper plastic track. Recessed brushed aluminum finger pulls. No lock. Metal hutch supports. Laminate back board. 15.75" clearance between worksurface and underside. Shipped Partially Assembled.

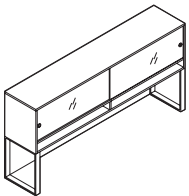

Hutch w/Glass Doors*

PN3560CH	16 x 60 x 35	125	120	19.44	\$1999
PN3572CH	16 x 72 x 35	125	144	23.33	\$2149
PN3584CH	16 x 84 x 35	150	145	25	\$2359

Sliding glass doors in upper aluminum track. Satin etched 6mm glass. Brushed aluminum finger pulls. No lock. Metal hutch supports. Laminate back board. 15.75" clearance between worksurface and underside. Shipped Partially Assembled.

Required Specifications

- Top finish
- Base finish
- Door finish (laminated doors)
- Hutch support finish*

Optional Specifications

- HP laminate (29"H bookshelves)

DESKTOP AND OVERHEAD STORAGE

MODEL# DIMENSIONS FREIGHT CLASS WT/LBS. CUBIC FT. LIST PRICE

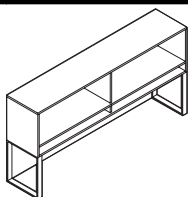

Open Hutch*

	D x W x H				
PN3560CHO	16 x 60 x 35	125	124	18	\$1201
PN3572CHO	16 x 72 x 35	125	128	21	\$1236
PN3584CHO	16 x 84 x 35	150	138	25	\$1335

Metal hutch supports. Laminate back board. 15.75" clearance between worksurface and underside. Shipped Partially Assembled.

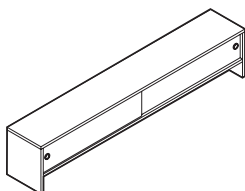

Desktop Storage w/Laminate Doors

PN1160LDS	11 x 60 x 12	100	54	6.50	\$721
PN1172LDS	11 x 72 x 12	100	62	7.75	\$777

Sliding laminate doors in upper plastic track. Recessed brushed aluminum finger pulls. No lock. Shipped Fully Assembled.

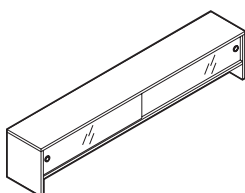

Desktop Storage w/Glass Doors

PN1160DS	11 x 60 x 12	100	43	4.58	\$1160
PN1172DS	11 x 72 x 12	100	51	5.50	\$1308

Sliding glass doors in upper aluminum track. Satin etched 6mm glass. Recessed aluminum finger pulls. No lock. Shipped Fully Assembled.

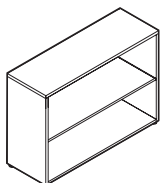

Desktop Shelf - Two High w/Laminate Shelf

PN2423LDB	12 x 24 x 23	60	45	1.50	\$341
PN3023LDB	12 x 30 x 23	60	49	1.50	\$372
PN3623LDB	12 x 36 x 23	65	53	2	\$376
PN2425LDB	12 x 24 x 25	60	47	1.50	\$341
PN3025LDB	12 x 30 x 25	65	51	2	\$372
PN3625LDB	12 x 36 x 25	65	55	2	\$376

One multiple-position adjustable laminate shelf. Shipped Fully Assembled.

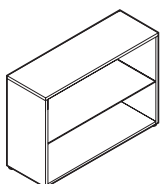

Desktop Shelf - Two High w/Glass Shelf

PN2423GDB	12 x 24 x 23	60	45	1.50	\$392
PN3023GDB	12 x 30 x 23	60	49	1.50	\$429
PN3623GDB	12 x 36 x 23	65	53	2	\$457
PN2425GDB	12 x 24 x 25	60	47	1.50	\$392
PN3025GDB	12 x 30 x 25	65	51	2	\$429
PN3625GDB	12 x 36 x 25	65	55	2	\$457

One multiple-position adjustable glass shelf. Shipped Fully Assembled.

Required Specifications

- Top finish
- Base finish
- Door finish (laminate doors)
- Hutch support finish*

DESKTOP AND OVERHEAD STORAGE

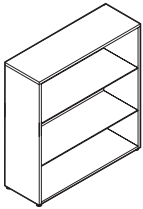

Desktop Shelf - Three High w/Laminate Shelves

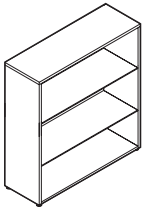

Desktop Shelf - Three High w/Glass Shelves

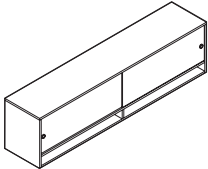

Large Overhead Storage w/Laminate Doors, Wall-Mounted

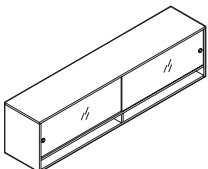

Large Overhead Storage w/Glass Doors Wall-Mounted

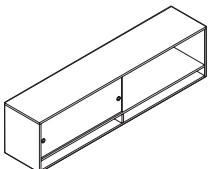

Large Overhead Storage w/Single Laminate Door, Wall-Mounted

MODEL#	DIMENSIONS D x W x H	FREIGHT CLASS	WT/LBS.	CUBIC FT.	LIST PRICE
PN2437LDB	12 x 24 x 37	65	58	2	\$426
PN3037LDB	12 x 30 x 37	70	64	3	\$453
PN3637LDB	12 x 36 x 37	65	71	3	\$471
PN2439LDB	12 x 24 x 39	65	58	2	\$426
PN3039LDB	12 x 30 x 39	70	64	3	\$453
PN3639LDB	12 x 36 x 39	65	71	3	\$471

Two multiple-position adjustable laminate shelves. Shipped Fully Assembled.

PN2437GDB	12 x 24 x 37	65	58	2	\$549
PN3037GDB	12 x 30 x 37	70	64	3	\$608
PN3637GDB	12 x 36 x 37	65	71	3	\$633
PN2439GDB	12 x 24 x 39	65	58	2	\$549
PN3039GDB	12 x 30 x 39	70	64	3	\$608
PN3639GDB	12 x 36 x 39	65	71	3	\$633

Two multiple-position adjustable glass shelves. Shipped Fully Assembled.

PN1960LWH	16 x 60 x 19	100	119	13.25	\$1015
PN1972LWH	16 x 72 x 19	100	138	16	\$1061
PN1984LWH	16 x 84 x 19	100	158	19	\$1167

Sliding laminate doors in upper plastic track. Recessed brushed aluminum finger pulls. No lock. Shipped Fully Assembled.

• **NOTE:** Care should be taken to mount the units. Units should be mounted to wall studs using correct fasteners. Failure to do so may result in collapse of the unit and subsequent personal injury. **Mounting hardware not included.** Mounting hardware used should be based on wall material. Consult an installation professional for proper wall mounting.

PN1960WH	16 x 60 x 19	100	101	10.56	\$1584
PN1972WH	16 x 72 x 19	100	121	12.67	\$1776
PN1984WH	16 x 84 x 19	100	158	19	\$1946

Sliding glass doors in upper aluminum track. Satin etched 6mm glass. Brushed aluminum finger pulls. No lock. Shipped Fully Assembled.

• **NOTE:** Care should be taken to mount the units. Units should be mounted to wall studs using correct fasteners. Failure to do so may result in collapse of the unit and subsequent personal injury. **Mounting hardware not included.** Mounting hardware used should be based on wall material. Consult an installation professional for proper wall mounting.

PN1960LS	16 x 60 x 19	100	117	13.25	\$944
PN1972LS	16 x 72 x 19	100	136	16	\$992
PN1984LS	16 x 84 x 19	100	156	19	\$1090

Sliding laminate door in upper plastic track. Recessed brushed aluminum finger pulls. No lock. Shipped Fully Assembled.

• **NOTE:** Care should be taken to mount the units. Units should be mounted to wall studs using correct fasteners. Failure to do so may result in collapse of the unit and subsequent personal injury. **Mounting hardware not included.** Mounting hardware used should be based on wall material. Consult an installation professional for proper wall mounting.

Required Specifications

- Top finish
- Base finish
- Door finish (laminate doors)

DESKTOP AND OVERHEAD STORAGE

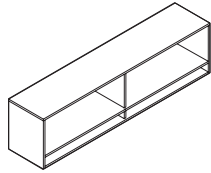

Large Overhead Storage, Wall-Mounted

MODEL# DIMENSIONS FREIGHT CLASS WT/LBS. CUBIC FT. LIST PRICE

D x W x H

PN1960WHO	16 x 60 x 19	100	112	13.25	\$854
PN1972WHO	16 x 72 x 19	100	131	16	\$889
PN1984WHO	16 x 84 x 19	125	151	19	\$988

Open storage with center divider. Shipped Fully Assembled.

• **NOTE:** Care should be taken to mount the units. Units should be mounted to wall studs using correct fasteners. Failure to do so may result in collapse of the unit and subsequent personal injury. **Mounting hardware not included.** Mounting hardware used should be based on wall material. Consult an installation professional for proper wall mounting.

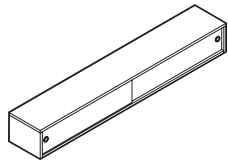

Small Overhead Storage w/Laminate Doors, Wall-Mounted

PN1260LWH	12 x 60 x 8	100	49	5.25	\$744
PN1272LWH	12 x 72 x 8	100	56	6.25	\$806
PN1284LWH	12 x 84 x 8	100	64	8	\$847

Sliding laminate doors in upper plastic track. Recessed brushed aluminum finger pulls. No lock. Shipped Fully Assembled.

• **NOTE:** Care should be taken to mount the units. Units should be mounted to wall studs using correct fasteners. Failure to do so may result in collapse of the unit and subsequent personal injury. **Mounting hardware not included.** Mounting hardware used should be based on wall material. Consult an installation professional for proper wall mounting.

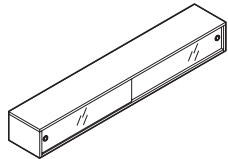

Small Overhead Storage w/Glass Doors Wall-Mounted

PN1260WH	12 x 60 x 8	100	31	3.33	\$1456
PN1272WH	12 x 72 x 8	100	38	4	\$1641
PN1284WH	12 x 84 x 8	100	64	8	\$1735

Sliding glass doors in upper aluminum track. Satin etched 6mm glass. Brushed aluminum finger pulls. No lock. Shipped Fully Assembled.

• **NOTE:** Care should be taken to mount the units. Units should be mounted to wall studs using correct fasteners. Failure to do so may result in collapse of the unit and subsequent personal injury. **Mounting hardware not included.** Mounting hardware used should be based on wall material. Consult an installation professional for proper wall mounting.

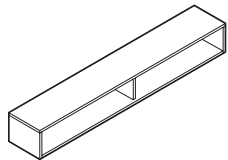

Small Overhead Storage, Wall-Mounted

PN1260WHO	12 x 60 x 8	100	45	5.25	\$570
PN1272WHO	12 x 72 x 8	100	52	6.25	\$641
PN1284WHO	12 x 84 x 8	125	60	8	\$697

Open storage shelf with center divider. Shipped Fully Assembled.

• **NOTE:** Care should be taken to mount the units. Units should be mounted to wall studs using correct fasteners. Failure to do so may result in collapse of the unit and subsequent personal injury. **Mounting hardware not included.** Mounting hardware used should be based on wall material. Consult an installation professional for proper wall mounting.

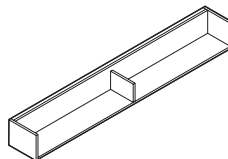

Wall-Mounted Shelf

PN1260WHS	12 x 60 x 8	150	31	5.50	\$423
PN1272WHS	12 x 72 x 8	125	37	6	\$458
PN1284WHS	12 x 84 x 8	125	44	7	\$494

Open storage shelf with center divider. Shipped Fully Assembled.

• **NOTE:** Care should be taken to mount the units. Units should be mounted to wall studs using correct fasteners. Failure to do so may result in collapse of the unit and subsequent personal injury. **Mounting hardware not included.** Mounting hardware used should be based on wall material. Consult an installation professional for proper wall mounting.

Required Specifications

- Top finish
- Base finish
- Door finish (lamine doors)

TACKBOARD NOTES

D x W x H

TACKBOARD Notes: Tackboards can be upholstered in all of the following fabrics:

Grade 1: Agate II, Hudson, Jenny, Quilt, Terrace, Urban, Waterfall

Grade 2: Crescent, Imprint, Lola, Match, Quadrille, Renewal, Replay, Silhouette

Grade 3: Anchorage, Brinx, Mariposa

Grade 4: Accent

Grade 5: Meander, Tracery, Universe

TACKBOARDS

MODEL# DIMENSIONS FREIGHT CLASS WT/LBS. CUBIC FT. FABRIC GRD. LIST PRICE

PN1556TBH	1 x 56 x 14.5	100	9.50	1	1	\$425
					2	\$509
					3	\$611
					4	\$733
					5	\$843
PN1568TBH	1 x 68 x 14.5	92.5	11	1	1	\$443
					2	\$532
					3	\$637
					4	\$764
					5	\$879
PN1580TBH	1 x 80 x 14.5	125	10	1.50	1	\$705
					2	\$846
					3	\$1014
					4	\$1217
					5	\$1400

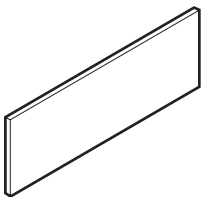

Tackboard for Hutches

Attaches with Velcro to Hutch backboard.

Required Specifications

Fabric

TACKBOARDS

MODEL# DIMENSIONS FREIGHT CLASS WT/LBS. CUBIC FT. FABRIC GRD. LIST PRICE

D x W x H

PN1560TBW	1 x 60 x 14.5	85	14	1	1	\$435
					2	\$522
					3	\$626
					4	\$751
					5	\$865
PN1566TBW	.62 x 66 x 14.4	85	12	1	1	\$581
					2	\$698
					3	\$837
					4	\$1005
					5	\$1155
PN1572TBW	1 x 72 x 14.5	70	16.50	1	1	\$508
					2	\$610
					3	\$732
					4	\$878
					5	\$1010
PN1578TBW	.62 x 78 x 14.4	100	14	1.50	1	\$732
					2	\$878
					3	\$1052
					4	\$1263
					5	\$1453
PN1584TBW	.62 x 84 x 14.4	92.5	15	1.50	1	\$797
					2	\$956
					3	\$1146
					4	\$1376
					5	\$1582

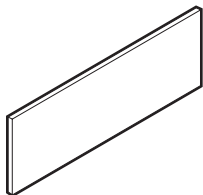

Tackboard for Overhead Storage

Attaches with adhesive-backed Velcro.

Required Specifications

Fabric

ELECTRICAL / DATA

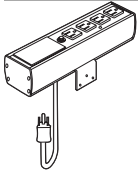

4 Outlet, 1 Telecom Blank Plate

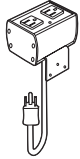

2 Outlet Power Block

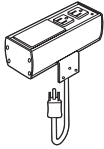

2 Outlet, 1 Telecom Blank Plate

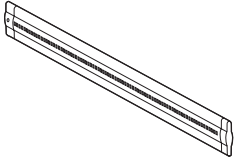

LED Task Light



Wire Manager

MODEL#	DIMENSIONS D x W x H	FREIGHT CLASS	WT/LBS.	CUBIC FT.	LIST PRICE
PGDPS41	2.5 x 10.25 x 2.22	70	1.50	.02	\$189
4 power receptacles and 1 telecom blank plate. For mounting behind pull-out shelf or open space credenza. Tungsten (TUN) finish. 12 foot black cord.					
PGDPS20	2.5 x 3.58 x 2.22	70	1	.01	\$135
2 power receptacles. For side mounted installation. Tungsten (TUN) finish. 12 foot black cord.					
PGDPS21	2.5 x 6.75 x 2.22	70	1.25	.01	\$175
2 power receptacles and 1 telecom blank plate. For side mounted installation. Tungsten (TUN) finish. 12 foot black cord.					
PLED30	1.5 x 15.5 x .5	150	2	.50	\$392
PLED50	1.5 x 23.5 x .5	150	2	.50	\$451
PLED100	1.5 x 43.5 x .5	125	3	.50	\$523
Energy efficient LED. Ultra slim design. Suitable for hanging under Hutch or Wallhung units. 6' power cord.					
PEWM5.5	2 x 66 x 2	70	.60	.10	\$156
PEWM5	2 x 60 x 2	70	.60	.10	\$131
PEWM4.5	2 x 54 x 2	70	.50	.10	\$117
PEWM4	2 x 48 x 2	70	.50	.10	\$106
PEWM3.5	2 x 42 x 2	70	.40	.10	\$91
PEWM3	2 x 36 x 2	70	.40	.10	\$81
PEWM2.5	2 x 30 x 2	70	.30	.10	\$66
PEWM2	2 x 24 x 2	70	.30	.10	\$55
PEWM1.5	2 x 18 x 2	70	.20	.10	\$42
PEWM1	2 x 12 x 2	70	.20	.10	\$30
Plastic tray flexes to receive and hold electrical and data wires. Quickly attaches with two strips of double-sided tape. Black (BLK) only.					

TABLES

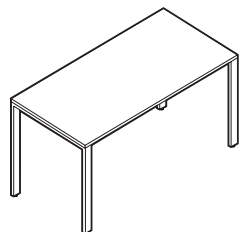

29" H Table

MODEL#	DIMENSIONS	FREIGHT CLASS	WT./LBS.	CUBIC FT.	LIST PRICE	HP ADD
D x W x H						
PN242429	24 x 24 x 29	150	53	10	\$772	\$107
PN482429	24 x 48 x 29	125	71	10.50	\$824	\$115
PN542429	24 x 54 x 29	125	83	13	\$978	\$136
PN602429	24 x 60 x 29	125	86	13	\$995	\$139
PN662429	24 x 66 x 29	125	90	14	\$1016	\$141
PN722429	24 x 72 x 29	150	97	21	\$1023	\$142
PN782429	24 x 78 x 29	150	101	21	\$1121	\$156
PN842429	24 x 84 x 29	150	106	22	\$1212	\$168
PN902429	24 x 90 x 29	150	110	23	\$1273	\$177
PN962429	24 x 96 x 29	150	123	24	\$1319	\$182
PN303029	30 x 30 x 29	150	66	12	\$850	\$118
PN483029	30 x 48 x 29	150	77	13	\$905	\$125
PN543029	30 x 54 x 29	150	94	16	\$1066	\$148
PN603029	30 x 60 x 29	125	99	16.50	\$1073	\$149
PN663029	30 x 66 x 29	125	105	17	\$1104	\$153
PN723029	30 x 72 x 29	150	112	23	\$1121	\$156
PN783029	30 x 78 x 29	150	119	26	\$1225	\$170
PN843029	30 x 84 x 29	150	132	27	\$1315	\$182
PN903029	30 x 90 x 29	150	139	33	\$1376	\$191
PN963029	30 x 96 x 29	150	143	29.50	\$1409	\$195
PN363629	36 x 36 x 29	150	80	15	\$904	\$125
PN603629	36 x 60 x 29	150	113	20	\$1232	\$170
PN663629	36 x 66 x 29	150	119	21	\$1272	\$176
PN723629	36 x 72 x 29	150	128	29	\$1291	\$179
PN783629	36 x 78 x 29	150	135	31	\$1273	\$177
PN843629	36 x 84 x 29	150	150	32	\$1363	\$189
PN903629	36 x 90 x 29	150	161	33.50	\$1464	\$203
PN963629	36 x 96 x 29	150	164	35	\$1479	\$204
PN424229	42 x 42 x 29	150	96	17	\$1043	\$145
PN604229	42 x 60 x 29	150	125	22	\$1288	\$179
PN664229	42 x 66 x 29	150	134	23	\$1328	\$185
PN724229	42 x 72 x 29	150	142	32	\$1355	\$188
PN784229	42 x 78 x 29	150	150	35	\$1506	\$209
PN844229	42 x 84 x 29	150	167	36	\$1642	\$227
PN904229	42 x 90 x 29	150	176	38	\$1760	\$244
PN964229	42 x 96 x 29	150	182	40	\$1795	\$248
PN484829	48 x 48 x 29	150	114	21	\$1077	\$150
PN604829	48 x 60 x 29	150	138	26	\$1335	\$185
PN664829	48 x 66 x 29	150	147	27	\$1381	\$191
PN724829	48 x 72 x 29	150	158	38	\$1400	\$194
PN784829	48 x 78 x 29	150	166	40	\$1583	\$219
PN844829	48 x 84 x 29	150	184	42	\$1718	\$238
PN904829	48 x 90 x 29	150	193	43	\$1835	\$253
PN964829	48 x 96 x 29	150	202	45	\$1864	\$258

Freestanding. 1" x 2.5" open metal frame legs with levelers, finished in Tungsten (TUN), Designer White (DWT) or Black (BLK). Metal support hat channel(s) provided on tables exceeding 54" in width. Shipped in 2 cartons.

Required Specifications

Top finish
Leg finish

Optional Specifications

HP laminate

Accessories

Wire manager
Desktop screen

TABLES **MODEL#** **DIMENSIONS** **FREIGHT CLASS** **WT/LBS.** **CUBIC FT.** **LIST PRICE** **HP ADD**

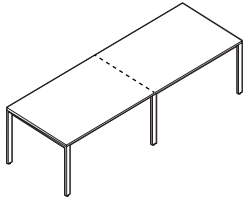

29" H Table with Center Leg

	D x W x H						
PN1203629	36 x 120 x 29	250	221	86.83	\$2254	\$312	
PN1443629	36 x 144 x 29	250	246	97.31	\$2387	\$330	
PN1204229	42 x 120 x 29	250	246	101.8	\$2344	\$323	
PN1444229	42 x 144 x 29	250	287	110.7	\$2472	\$341	
PN1204829	48 x 120 x 29	250	271	113.7	\$2483	\$342	
PN1444829	48 x 144 x 29	250	291	116.7	\$2612	\$360	

Freestanding. 1" x 2.5" open metal frame legs with levelers, finished in Tungsten (TUN), Designer White (DWT) or Black (BLK). 120" and 144"W with 2 piece top. Metal support hat channel(s) provided on tables exceeding 54" in width. Shipped in 3 cartons.

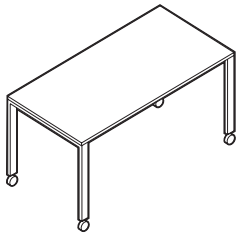

29" H Table with Casters

PN242429C	24 x 24 x 29	92.5	53	4.50	\$797	\$112	
PN482429C	24 x 48 x 29	85	71	5.26	\$846	\$118	
PN542429C	24 x 54 x 29	85	83	6.50	\$1014	\$141	
PN602429C	24 x 60 x 29	85	86	6.50	\$1033	\$143	
PN662429C	24 x 66 x 29	85	90	7	\$1051	\$146	
PN722429C	24 x 72 x 29	85	97	7	\$1068	\$149	
PN303029C	30 x 30 x 29	92.5	66	6	\$877	\$122	
PN483029C	30 x 48 x 29	100	77	9.50	\$926	\$129	
PN543029C	30 x 54 x 29	92.5	94	8	\$1102	\$153	
PN603029C	30 x 60 x 29	92.5	99	8.26	\$1110	\$154	
PN663029C	30 x 66 x 29	85	105	8.50	\$1135	\$157	
PN723029C	30 x 72 x 29	85	112	9	\$1174	\$162	
PN363629C	36 x 36 x 29	92.5	80	7.50	\$921	\$127	
PN603629C	36 x 60 x 29	92.5	113	10	\$1163	\$161	
PN663629C	36 x 66 x 29	92.5	119	10.50	\$1192	\$164	
PN723629C	36 x 72 x 29	100	124	14.50	\$1363	\$189	
PN424229C	42 x 42 x 29	92.5	96	8.50	\$1067	\$149	
PN484829C	48 x 48 x 29	150	114	21	\$1105	\$153	

Freestanding. 1" x 2.5" open metal frame legs with casters, finished in Tungsten (TUN), Designer White (DWT) or Black (BLK). All casters are locking. Metal support hat channel(s) provided on tables exceeding 54" in width. Shipped in 2 cartons.

Required Specifications

Top finish
Leg finish

Optional Specifications

HP laminate

Accessories

Wire manager
Desktop screen



Zira™ is a contemporary desking solution with extensive options to personalize your workspace. Components can be freestanding for single workstation configurations, or joined together to form multiple work groups. Create a work environment that meets your worksurface needs and storage requirements - then go ahead and personalize it!

Select from the following: hundreds of components for any size or shape office, storage components that can tower to 84" high, 20 laminate finishes, 5 edge options, 9 handle options in silver, black, nickel or brass finishes, 2 glazing options with 2 frame finishes on doors and modesty panels, and lastly, work surface grommets and power blocks for your electrical needs.

Zira is your most functional solution to work environment efficiency and organization.



Tops are available in a choice of 1" or 1 ½" thick with a variety of edge details and a top over side, edge panel design
* Shown with 1.5" thick top and Bicut Edge (CR).



Optional Frosted or Ribbed glazing on doors and modesty panels. Available with Silver or Black frames.



Collator option is available for the convenient storage of day-to-day documents. Available in Black or Brushed Cobalt finish.



Features and Benefits

- 45 lb. density particle board substructure with high performance thermally fused laminate
- Top over side panel design
- Worksurfaces feature preferred edging in matching color
- Available in 1" or 1.5" thick top with a variety of edge details
- 11/16" thick full modesty panel is standard
- 11/16" thick ¾ modesty panel available on most components
- Pencil tray included in box drawer
- Lateral file drawers can accommodate legal or letter documents
- Premium full extension progressive ball bearing slides on file drawers & box drawers
- All drawer fronts edge banded with side pull opening pedestals and standard pedestal locks
- Compatible with Divide partitioning system for increased privacy and storage requirements

GENERAL INFORMATION

- Over 5300 different standard components are available
- Zira components are compatible with **Divide** partitioning panels.
- Handles, lock finish and trim color (if applicable) **MUST MATCH**
- Dimensionally compatible with the Adaptabilities series.
- For environmental certification, please visit globalfurnituregroup.com

WORKSURFACES

- Available in 1" or 1.5" thick thermally fused laminate tops with a variety of edge details
- Tops are sealed with Global's preferred edge in matching color. Woodgrain surfaces feature edging with matching printed woodgrain.
- High pressure tops are available in all Zira laminate finishes at an extended lead time. Please see model # for pricing and availability.
- Products specified with the high pressure laminate option are finished on the underside of the surface with a kraft paper backing.

CONSTRUCTION

- Constructed of 45 lb. density particleboard with high performance thermally fused laminate
- All desks are size (incrementally) accurate
- Desk drawers/storage open with side pulls and feature a French dovetail joint in front, lap joint in back. Pulls are available for these units at an upcharge, see below. All other drawers/storage feature built-in pulls available in 9 different styles
- Virtually no loose hardware
- Models with Monopost are standard with 4" Square Monopost. Optional 5" Round and 4" Round Monopost are available at no upcharge. Available in Black (**BLK**) or Silver (**SIL**) finish. Please Specify
- Leveling glides are standard on all floor units
- Premium full extension progressive ball bearing slides on file drawers & box drawers
- All drawer fronts edge banded with side pull opening pedestals and standard pedestal locks

HEIGHT ADJUSTABLE DESKS

- Zira Height Adjustable Desks include a laminate chassis + height adjustable table frame sold separately.
- Use **FFHATZS** with all **ZAxxxxFxx** and **ZAxxxxNP** models.
- Use **FFHATZ9** with all **ZA60xx24L/R** models.
- Steel constructed leg tubing, feet and cross bar.
- Table frame designed with 3.15" x 2.35" rectangular outer leg with the larger tube attaching to a bracket within the pedestal.
- Select width of base: (**S**) for 60"/66" wide desks, (**M**) for 72"/84" wide desks.
- Powder coat finishes for bases is standard in Designer White (**DWT**), Black (**BLK**) or Tungsten (**TUN**).
- Wire management channels available in Black (**BLK**) or Silver (**SIL**). Silver (**SIL**) matches Tungsten.
- Zira Height Adjustable desks have 2-stages and feature an adjustment range of 29.5"/30" – 49"/49.5".
- Lifts 265 pounds.
- Operates at 1.5" per second.
- Shadow power draw is 0.45 watts.
- Maximum power draw is 1.3 amps.
- All bases feature a dual actuator system with a motor driving each leg.
- Motors daisy-chain and connect directly to one another, without the need for a control box.

HANDSET

- Standard up/down handset (**SH**) (no digital readout). Black only.
- A Joggle Wheel Digital Handset with five programmable settings is optional, specify Digital Readout Handset (**DH**). Add **\$188**. Silver Only.
 - Digital Readout Handset (**DH**) is recommended when items above or below worksurface might impede full movement of the table. DH includes settings to program Upper and Lower Limits, Collision Detection, Sit Position and Stand Position

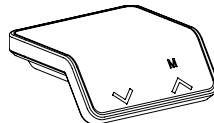

Standard handset (**SH**)

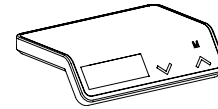

Digital readout handset (**DH**)

NOISE REDUCTION

- Industry leading operating sound level of 55dB is standard (**SI**).
- Optional whisper quiet sound insulation reduces level to operating sound level to 38dB. Specify Whisper Quiet Insulation (**QI**). Add **\$84**.

MODESTY PANELS

- Laminate full modesty panel is standard. Laminate ¾ modesty panel is available on select models at no additional charge. Please specify (**3MP**).
- Glazing options are available on the full modesty panel, ¾ modesty panel and the 12" modesty panel (where available). Please specify. See next page for options and codes.
- 11/16" thick full modesty panel is standard
- 11/16" thick ¾ modesty panel available on most components
- **Note:** Woodgrain modesty panels over 60" wide will have the grain pattern in the horizontal direction. All end panels and modesty panels 60" or less will have the grain pattern in the vertical direction

STORAGE

- All lateral files feature a foolproof interlock device
- Pencil tray included in box drawer
- Lateral file drawers can accommodate legal or letter documents
- All drawers are locking unless otherwise noted
- Front-to-back filing bars for all steel drawer files available separately. Order FBB bars. See Metal Filing + Storage price list page 118 for pricing.
- All desks, returns and credenzas with fixed storage are shipped standard with box/box/file, file/file or box/file 16" wide pedestals.
- Storage modules, wardrobe cabinets, personal towers, hutches and table top bookcases have 11/16" thick shelves
- End shelves, bookcases and table top end shelves have 1" thick shelves
- **All shelves are 3 position fixed/height adjustable**

LOCKS

- Locks are standard on all storage modules. Finish will coordinate with handles and/or aluminum doors. For desk, return or table components, etc. please specify finish: Black (**BK**) or Silver (**SI**).
- Please note that Flared Brass (**HW**) handle defaults to Black locks, so trim options must be Black to match.

SHIPPING

- Shipped assembled, 1 per carton, unless otherwise noted. Other components are easy to assemble.

CUSTOM WIDTHS

- Custom widths are available for products that feature a worksurface as follows: desks, credenzas (applies to kneespace and single pedestal credenzas only), islands (excludes spanner islands), returns, bridges, extended corners and corners.
- Desks and credenzas that incorporate drawers and/or doors will be modified by changing the width of the worksurface and modesty panel, drawer and/or door dimensions are not affected.
- No upcharge for next size up
- Custom width does not apply to cabinets, hutches, pedestals or any other units.

HUTCHES

- 71" hutches (actual width 71.69") are for use when a hutch is placed across the back of a 42" wide return and across the depth of a 30" deep surface top (actual depth 29.69").
 - ZxxxxDK, ZxxxxDM and ZxxxxDML/DMR are exactly 30" deep. Therefore 72" hutches may be used.
- Hutches should not be placed on the approach side of any single pedestal and double pedestal desks with an overhang.

1. SPECIFY MODEL NUMBER

2. SPECIFY FINISH AND TOP THICKNESS/EDGE DETAIL

• All units available in solid color (Top and Chassis matching) or Two-Tone combination except for the following units:

- Shells: One Tone in all standard finishes
- Collators: One Tone in Black (K) or Brushed Cobalt (T)
- Horizontal Pigeon Holes: One Tone in all standard finishes
- Vertical and Transitional Pigeon Holes: Two-Tone - Chassis/Shell in all standard finishes, Collator Shelves in Black (K) or Brushed Cobalt (T).

Finishes:

ACJ	Absolute Acajou	HGT	Hayden Grey
ASN	Asian Night	QTM	Quartered Mahogany
AWC	Avant Cherry	SOG	Storm Grey
AWH	Avant Honey	TFW	Tiger Fruitwood
BLK	Black	TWL	Tiger Walnut
BRC	Brushed Cobalt	WHE	Walnut Heights
CMB	Clear Maple	WHC	White Chocolate
DES	Dark Espresso	WCR	Winter Cherry
DWT	Designer White	WGY	Willow Grey

Top Thickness/Edge Detail

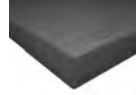

A3 1" top, standard flat edge

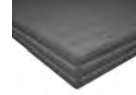

AR 1" top, bicut edge



C3 1.5" top, standard flat edge



CR 1.5" top, bicut edge



CF 1.5" top, fluted edge

3. SPECIFY OPTIONS

BOX DRAWERS (No Upcharge)

- Specify **B_** (Drawer Position **1-4** must be specified)

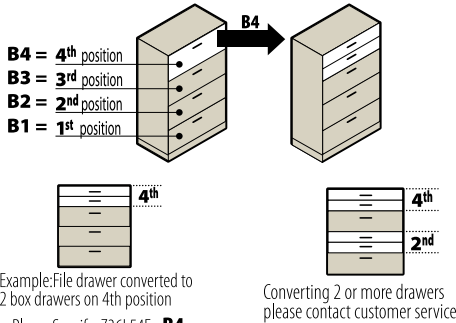

- *Not available on drawers with steel interiors*

HANDLES

- Handles are standard on most drawers/storage modules. All other Zira drawers, including mobile and hanging pedestals, can be ordered with a choice of nine handle options to be **factory installed**. Each handle is identified by the letters "HU", "HV", "HW", "HX", "HS", "HZ", "HO", "HQ", and "HR". To specify a handle, please specify the code after the model number. To order a handle as an option, please specify the code when ordering, List Price is **\$39**.



MONOPOST



P1 square 4" silver



P2 square 4" black



P3 round 4" silver



P4 round 4" black



P5 round 5" silver



P6 round 5" black

GROMMETS

- Additional grommets available in standard worksurface locations (left, center or right).
- Order as: **AG1, AG2 or AG3. Add \$69**
- Grommets may be placed at non-standard locations. Order as: **AGS - Add \$69**. A drawing must be supplied with vertical and horizontal dimensions to the center of the cut-out (as in drawing above). Please refer to **CUSTOM GROMMET LOCATION FORM** in the back reference section.
- Components that come standard with grommet as stated within the product descriptions or shown in the corresponding price list line art, may be ordered without a grommet. **Add \$37**.
- Option to remove standard grommet when required - specify **RSG - Add \$37**.
- Option to remove standard grommet position and add another position - specify RSG and AG_ or AGS, upcharge applies. For **RSG + AG_** combination, **Add \$106**. For **RSG + AGS** combination, **Add \$106**.

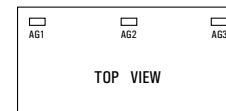
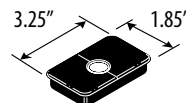

- Grommet hole dimensions are 3 1/4" wide x 1 7/8" deep.
- Actual grommet locations on the worksurface are depicted in the example drawings shown below. Dimensions shown are actual measurements (in inches).

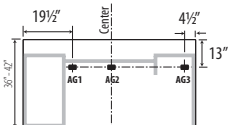

Straight Front

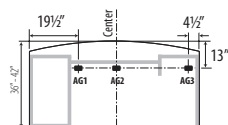

Bow Front

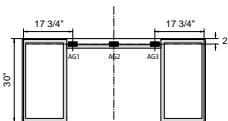

HA Double Ped

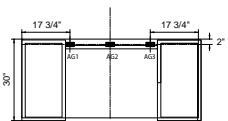
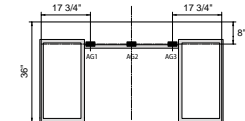

HA Single Ped

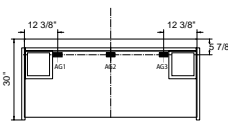
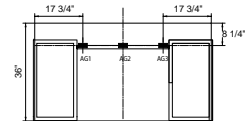

Freestanding HA

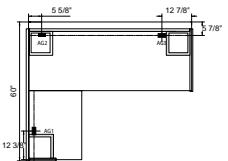
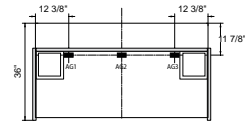

L HA desk

- Grommets are available on modesty panels of **extended corners** and **5-sided corners** 8" in where the two modesty panels meet at a 90° angle. Please specify **FOGMP-R** for right grommet placement and **FOGMP-L** for left grommet (placement is as shown on diagrams below). Cost is **\$69**.

**** Modesty Panels are 1" off of ground**

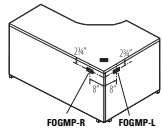

Left Extended Corner Unit

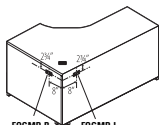

Right Extended Corner Unit

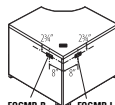

5-Sided Corner Unit

POWER BLOCK

- A Power Block (model **PMSPDM**) may be ordered on all worksurfaces.
- A Power Block is a rectangular worksurface power/data module with one electrical duplex receptacle and two data (RJ45) receptacles. 9 foot black cord included. Power Block dimensions are 3 1/2" deep x 6 1/2" wide x 2 3/4" high.
- To purchase a Power Block, you must specify both the Power Block cut-out location and the Power Block model #. Order Power Block as **PMSPDM**, **Add \$261**. Power Blocks are available in standard worksurface locations (left, center or right). Order as E1, E2 or E3. **Add \$69**.



Power Block **PMSPDM** Add **\$261**

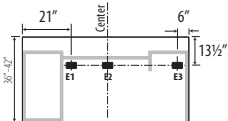

Straight Front

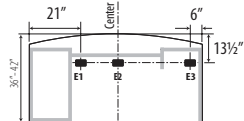

Bow Front

Specify location **E1, E2 or E3** Add **\$69**

GLAZING (Doors and Modesty Panels)



Z1 Frosted Glazing, Silver Frame



Z2 Frosted Glazing, Black Frame



Z3 Ribbed Glazing, Silver Frame

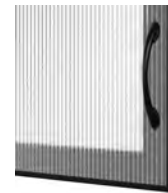

Z4 Ribbed Glazing, Black Frame



Full modesty panel - **Z1** Frosted Glazing, Silver Frame
 3/4 Modesty (Shown) - **Z1 + 3MP**
ZA - 12"H modesty (select models)



Full modesty panel - **Z2** Frosted Glazing, Black Frame
 3/4 Modesty (Shown) - **Z2 + 3MP**
ZB - 12"H modesty (select models)



Full modesty panel - **Z3** Ribbed Glazing, Silver Frame
 3/4 Modesty (Shown) - **Z3 + 3MP**
ZC - 12"H modesty (select models)



Full modesty panel - **Z4** Ribbed Glazing, Black Frame
 3/4 Modesty (Shown) - **Z4 + 3MP**
ZD - 12"H modesty (select models)

Executive Height Adjustable Desks

Available widths: 60", 66", 72", 84"

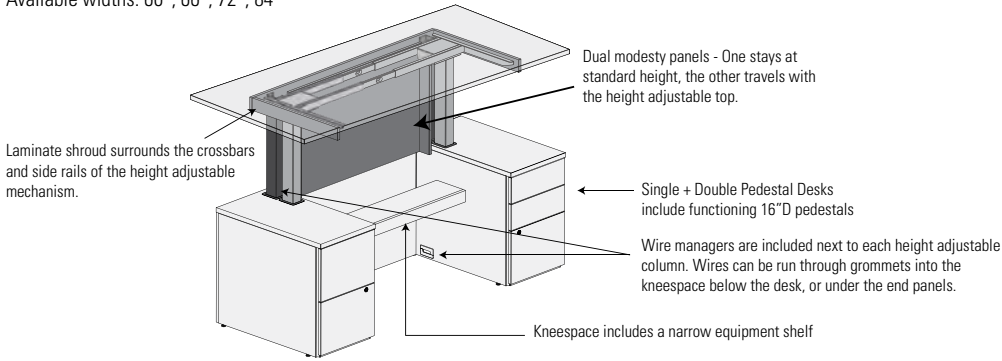

Returns

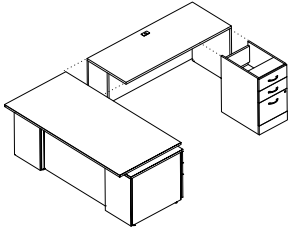

For "L" Shape Layouts

- Pre-configured
- With custom shell storage

Bridges

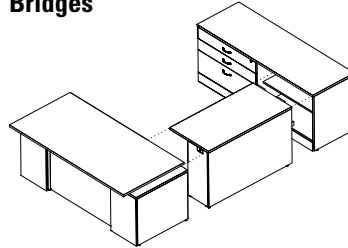

For "U" shape Layouts

Work Walls

Grommet locations for wall units

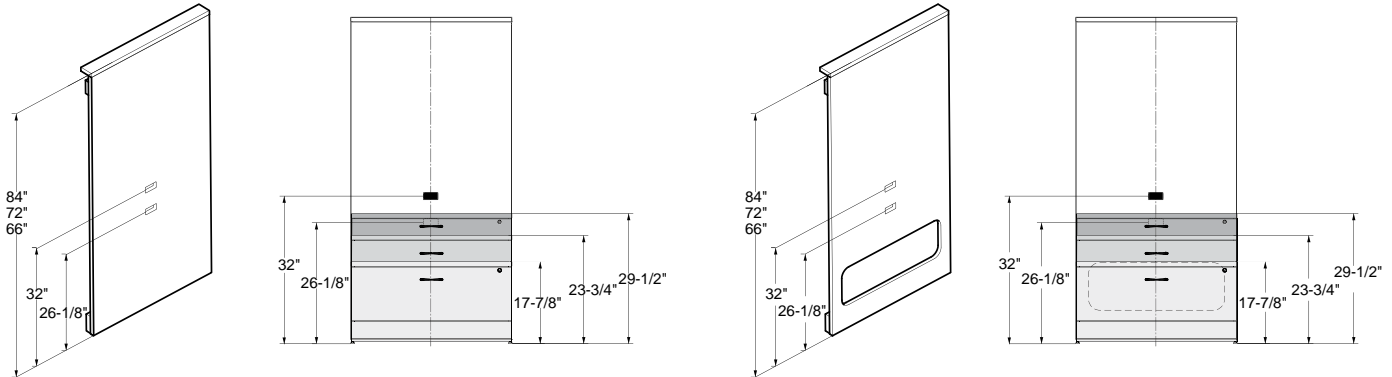

- AG1 grommet sits at 26-1/8" above the floor, just about 1-1/2 high storage, but below standard 29-1/2" storage
- AG2 grommet sits at 32" above the floor, above 29-1/2" storage
- When the wall with wire management access is specified, the wire management access opening will sit below all storage heights.

Desks / Extended Corner Desks - available width: 60", 66", 72", 84"

Modesty Treatments

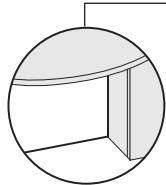
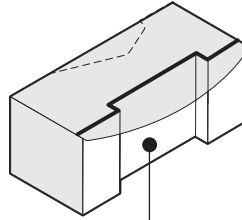

Laminate Full
(Standard)

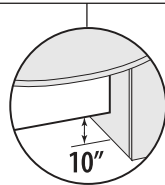

Laminate 3/4
(Specify: **3MP**)

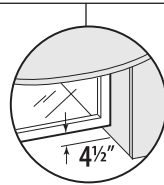

Glazing Full
(Specify: **Z_**)

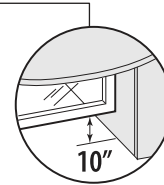

Glazing 3/4
(Specify: **Z_+3MP**)

Overhang Dimensions

Bow Desk

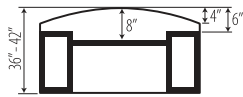

Laminate



Glazed Option



Straight Desk

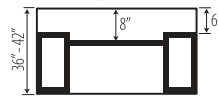

Laminate



Glazed Option



Freestanding Desk

(ZxxxxDK/DM/DML/DMR)

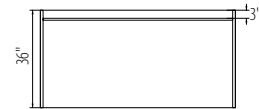

Laminate

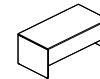

Glazed Option

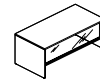

Returns - available width: 36", 42", 48", 54", 60", 66", 72"

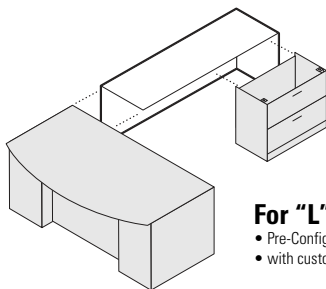

For "L" shape Layouts

- Pre-Configured
- with custom shell storage

Transitional Pigeon-Hole

Accepts all (same width) Transitional Pigeon-Holes.

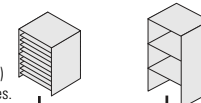
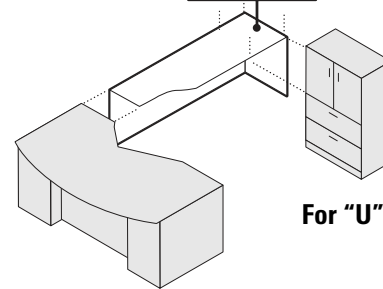

Table Top Bookcase

Accepts all (same width) Table Top Bookcases.



For "U" shape Layouts

Bridges - available width: 42", 48"

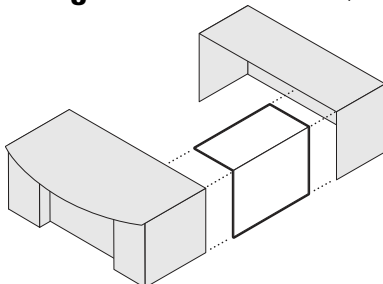

Regular Bridge

- join worksurface to worksurface

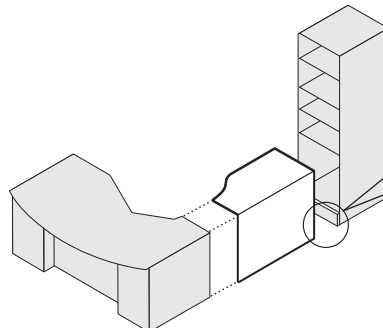

Transitional Bridge

- join worksurface to storage modules

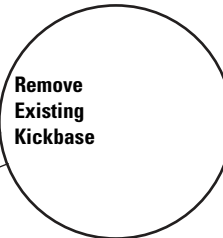

Remove Existing Kickbase

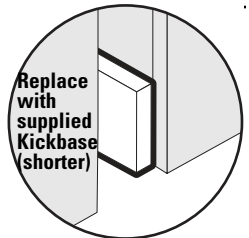

Replace with supplied Kickbase (shorter)

Extended Corners - available widths: 60", 66", 72", 84"

Modesty Treatments

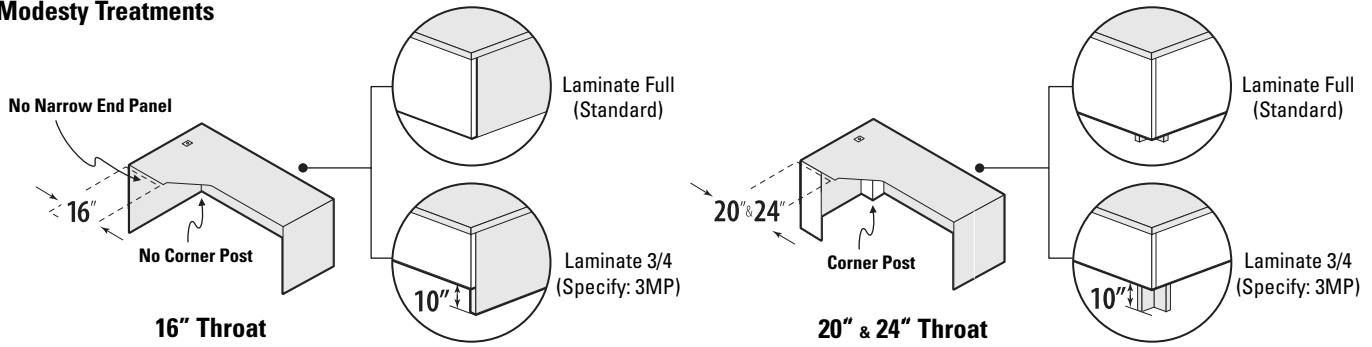

Extended Corner Islands - available width: 60", 66", 72" 84"

Modesty Treatments

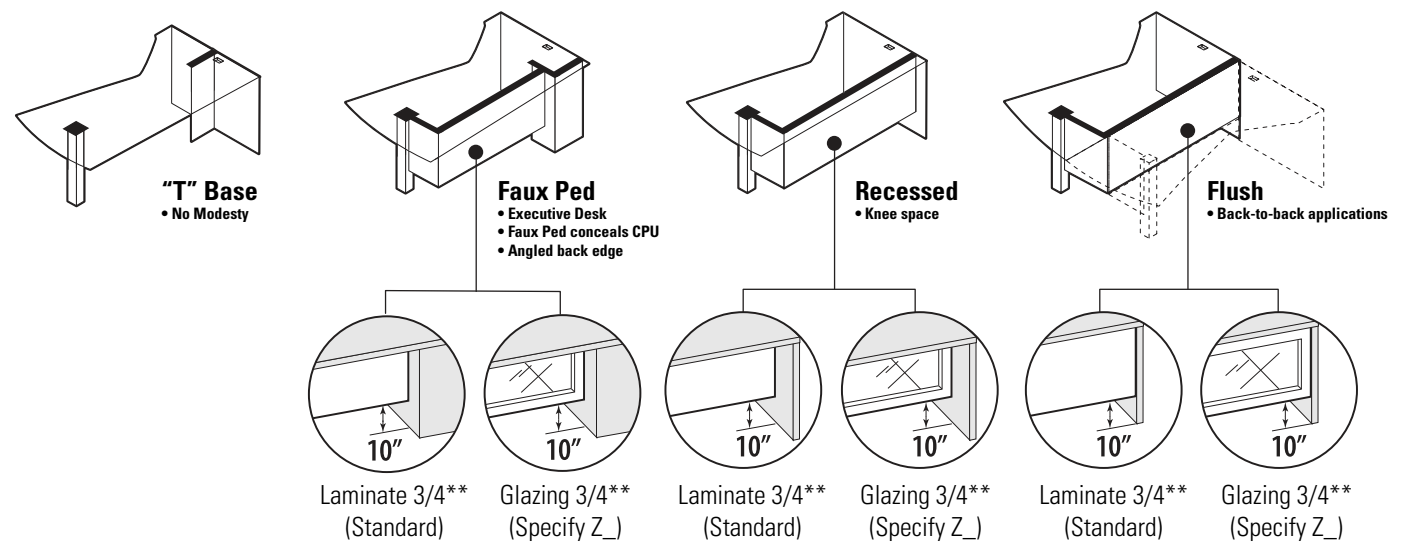

** Full modesty not available

Overhang Dimensions



Shells - available width: 12", 15", 16", 18", 21", 30", 36"
 For Extended Corners, Space Saver Returns and Connectables

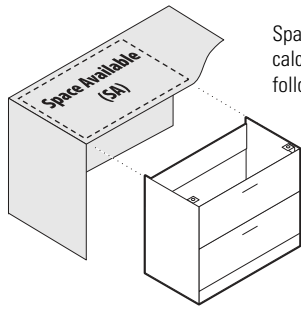

Space Available can be calculated with the following formulas:

Space Saver Returns

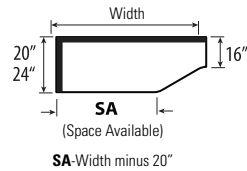

Space Saver Connectables

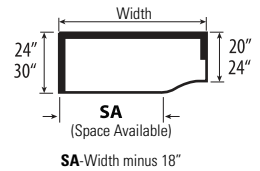

Extended Corners

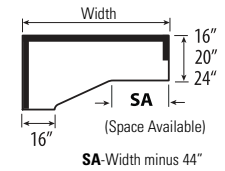
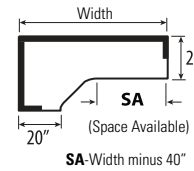
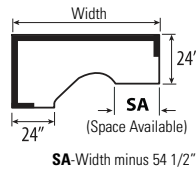

Storage

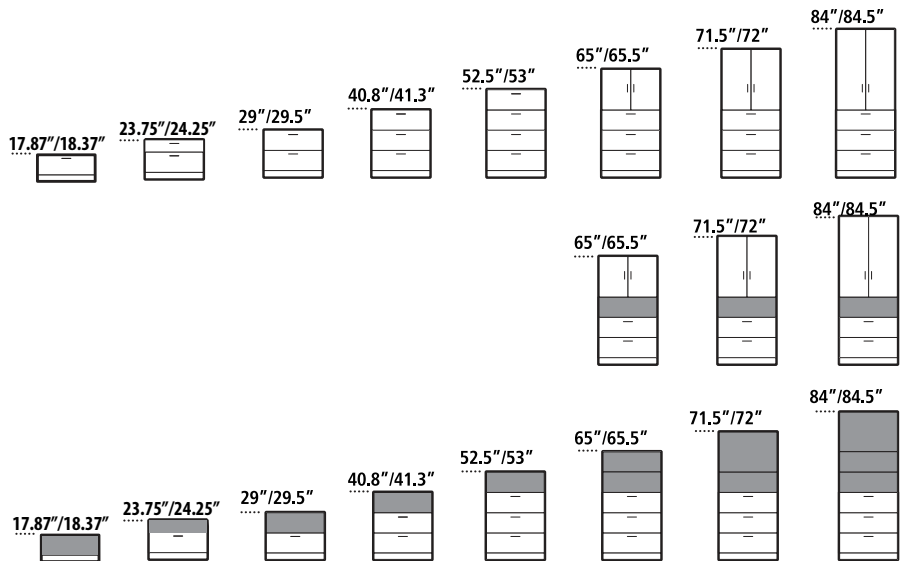
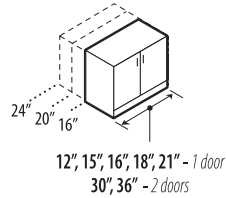
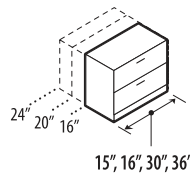
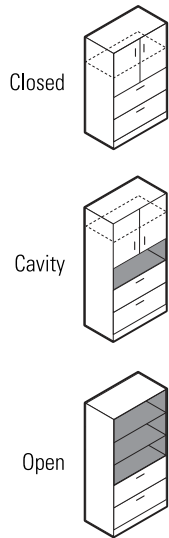

Wardrobe & Personal Towers

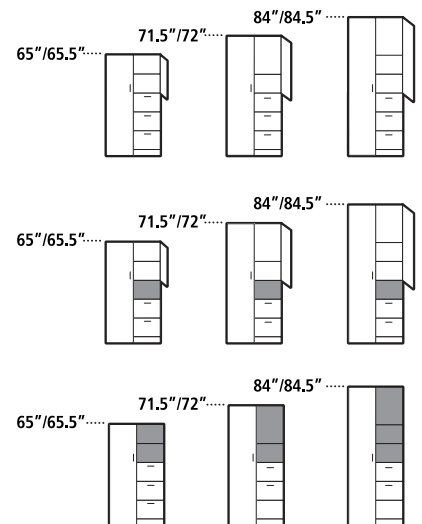
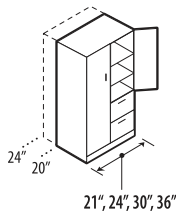
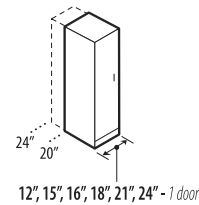
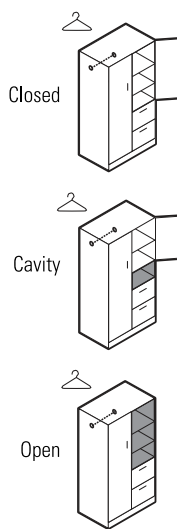

PC Support

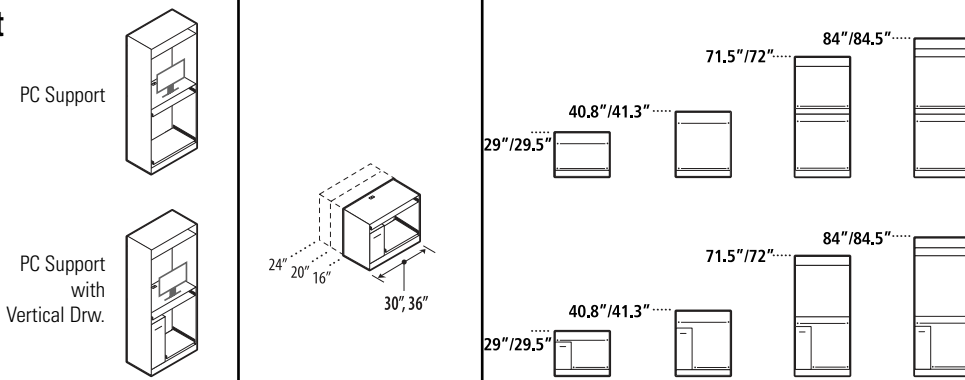

Vertical Utility Drawer

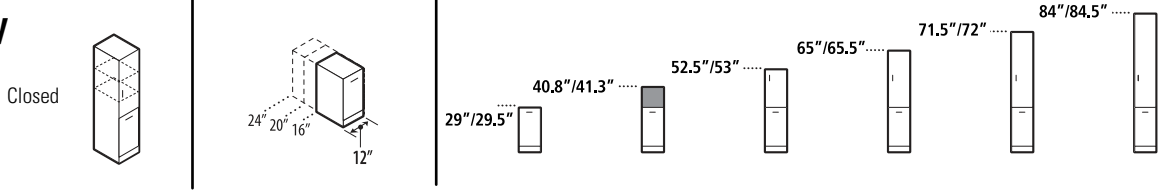

Drawer & Cavity Positions

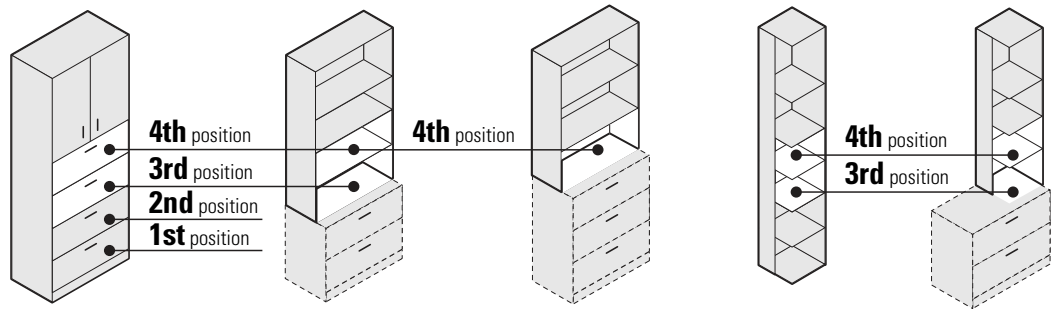

Box Drawer Option

File drawers can be converted to box/box drawers in any of the four standard positions

- B1** = 2 box drawers on 1st position
- B2** = 2 box drawers on 2nd position
- B3** = 2 box drawers on 3rd position
- B4** = 2 box drawers on 4th position

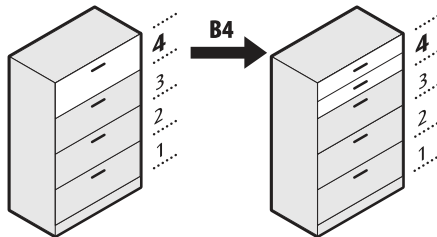

Example
File drawer converted to 2 box drawers on **4th** position

Please specify: Z36L54F - **B4**

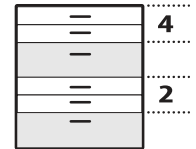

Converting 2 or more drawers please contact customer service.

Collator Positions

All storage units can be specified with an optional collator on 2nd, 3rd and/or 4th position.

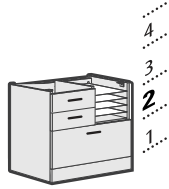

Collator on 2nd position
Specify: 2K - Black or
2T - Brushed Cobalt

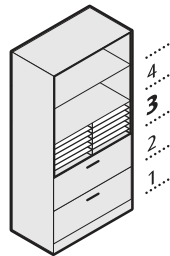

Collator on 3rd position
Specify: 3K - Black or
3T - Brushed Cobalt

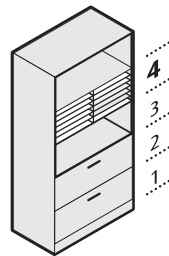

Collator on 4th position
Specify: 4K - Black or
4T - Brushed Cobalt

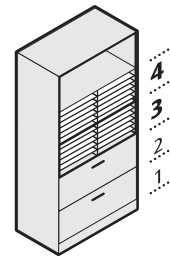

Collator on 3rd & 4th positions
Specify: 7K - Black or
7T - Brushed Cobalt

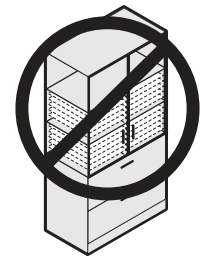

Collators do not fit behind doors

For 2K / 2T, 3K / 3T OR 4K / 4T - Add \$180

For 7K / 7T - Add \$358

Glazing

Glazing is available in the following options:

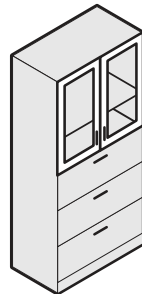

Silver Frame
Frosted Glazing
Z1

Please specify:
Z36L73F - **Z1**

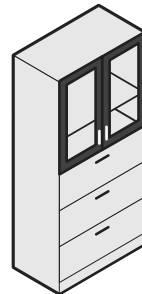

Black Frame
Frosted Glazing
Z2

Please specify:
Z36L73F - **Z2**

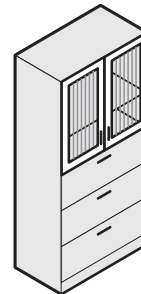

Silver Frame
Ribbed Glazing
Z3

Please specify:
Z36L73F - **Z3**

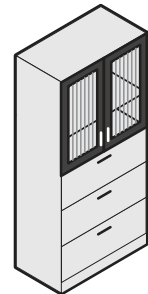

Black Frame
Ribbed Glazing
Z4

Please specify:
Z36L73F - **Z4**

Filing Options - For Filing Components

On 16" deep files, drawer interiors are only 13" deep. On 20" and 24" deep files, drawer interiors are 16" deep.
Full to floor BBF, FF and BF pedestals are 16" wide with all pedestal desks, returns with pedestals and credenzas with pedestals.
Full to floor BBF and FF storage shells 15" wide x 28.5" high are required under 36" wide Space Saver Return with 16" deep connection top. re: Zxx3616Rx.

Side-To-Side

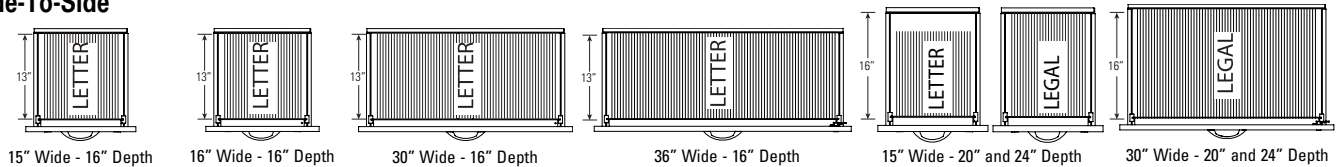

Front-To-Back

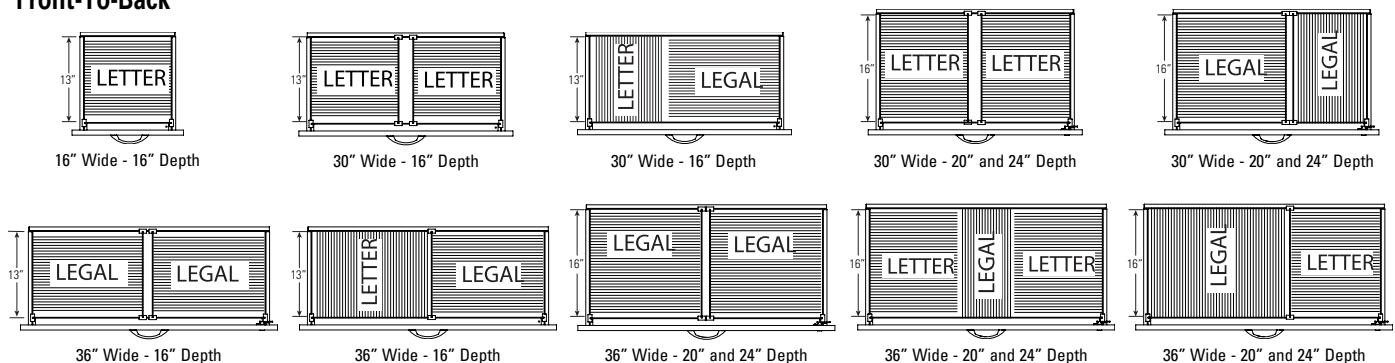

Height Map

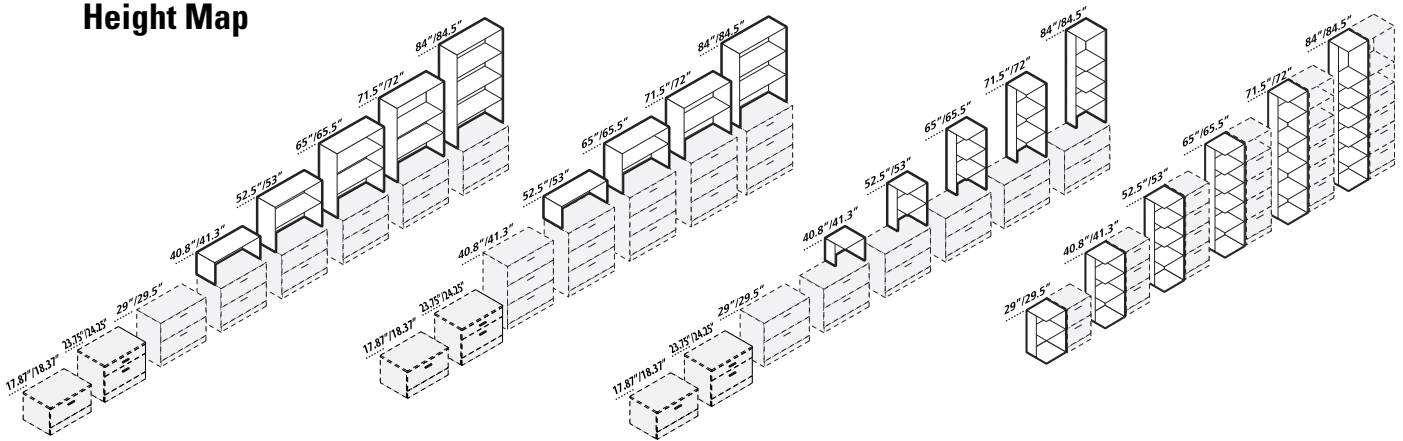

Drawer & Cavity Positions

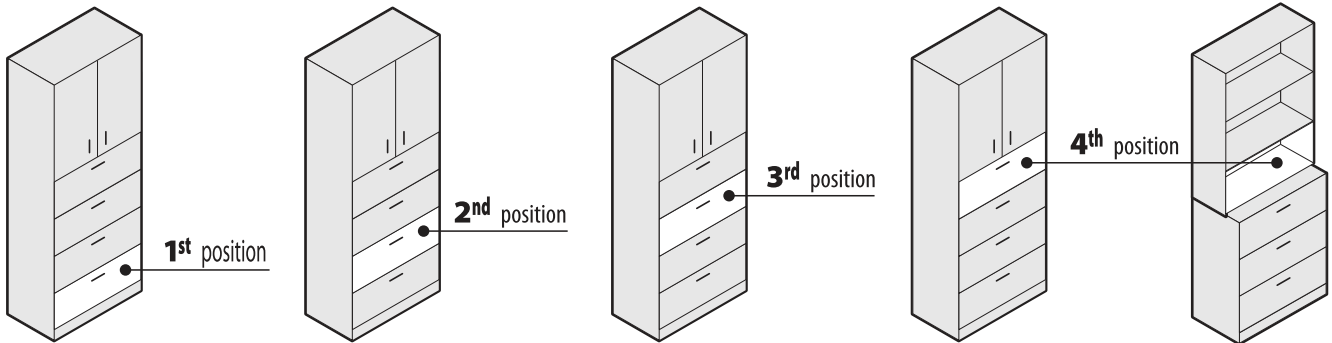

Collator Positions

For 12" to 21" wide units

**If no collator is desired, must specify when placing order.

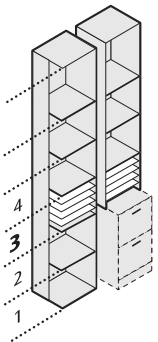

Collator on 3rd position
Specify: 3K - Black or
3T - Brushed Cobalt

For 3K / 3T or 4K / 4T.....Add \$180

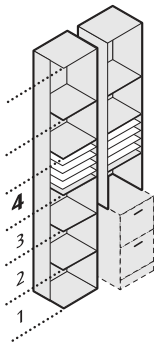

Collator on 4th position
Specify: 4K - Black or
4T - Brushed Cobalt

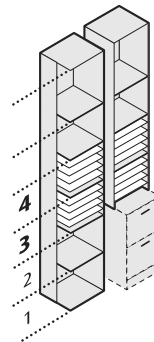

Collator on 3rd & 4th position
Specify: 7K - Black or
7T - Brushed Cobalt

For 7K / 7T.....Add \$358

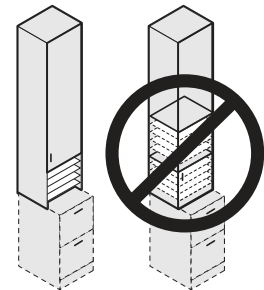

Collators do not fit behind door

Table Top Bookcase

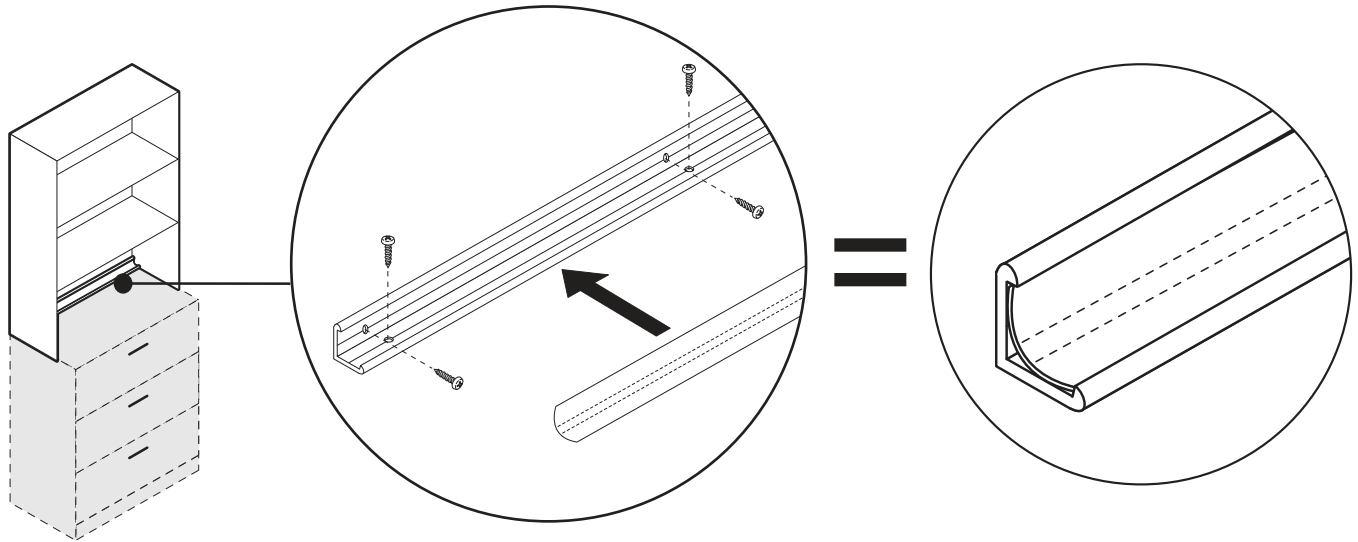

Hutches

Monitor clearance dimensions

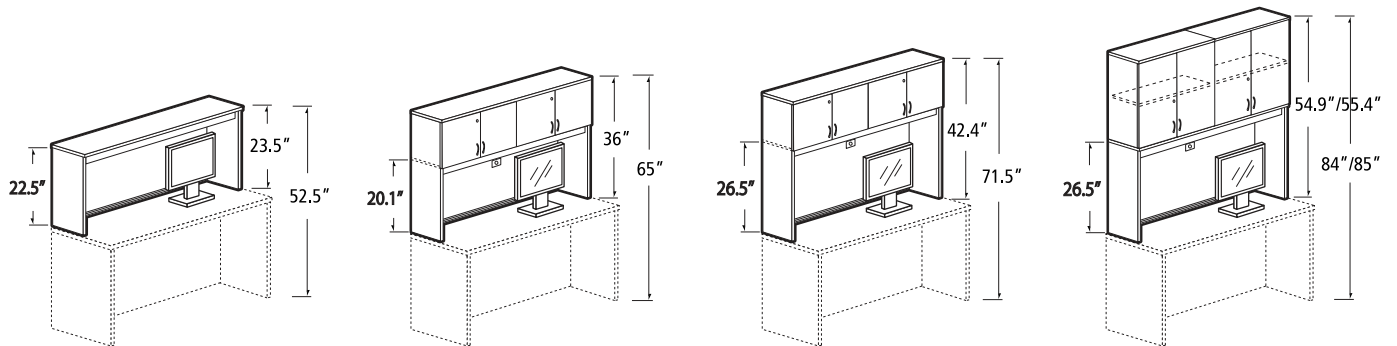

HEIGHT ADJUSTABLE DESKS

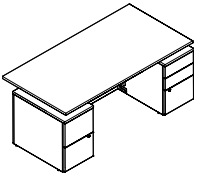

Height Adj. Desk - Double Pedestal

MODEL#	DIMENSIONS D x W x H	FREIGHT CLASS	WT/LBS.	CUBIC FT.	1" TOP	1.5" TOP	GLAZE ADD	HP ADD
ZA3684F23	36 x 84 x 29.5-49.5	85	362	26.68	\$2940	\$3112	\$482	\$514
ZA3672F23	36 x 72 x 29.5-49.5	85	335	26.68	\$2917	\$3070	\$413	\$440
ZA3666F23	36 x 66 x 29.5-49.5	85	321	25.18	\$2838	\$2977	\$371	\$403
ZA3660F23	36 x 60 x 29.5-49.5	85	307	24.70	\$2741	\$2880	\$399	\$366
ZA3084F23	30 x 84 x 29.5-49.5	85	347	25.69	\$3010	\$3159	\$482	\$426
ZA3072F23	30 x 72 x 29.5-49.5	85	321	24.70	\$2866	\$2996	\$413	\$366
ZA3066F23	30 x 66 x 29.5-49.5	85	309	24.19	\$2788	\$2909	\$371	\$338
ZA3060F23	30 x 60 x 29.5-49.5	85	296	23.68	\$2709	\$2816	\$403	\$306

Standard with file/file pedestal on **left** and box/box/file pedestal on **right**. File drawer and lower box drawer lock. File pedestal locks. Height adjustable frame sold separately.

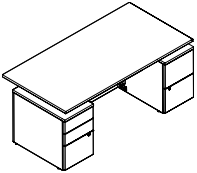

Height Adj. Desk - Double Pedestal

ZA3684F32	36 x 84 x 29.5-49.5	85	362	26.68	\$2940	\$3112	\$482	\$514
ZA3672F32	36 x 72 x 29.5-49.5	85	335	26.68	\$2917	\$3070	\$413	\$440
ZA3666F32	36 x 66 x 29.5-49.5	85	321	25.18	\$2838	\$2977	\$371	\$403
ZA3660F32	36 x 60 x 29.5-49.5	85	307	24.70	\$2741	\$2880	\$399	\$366
ZA3084F32	30 x 84 x 29.5-49.5	85	347	25.69	\$3010	\$3159	\$482	\$426
ZA3072F32	30 x 72 x 29.5-49.5	85	321	24.70	\$2866	\$2996	\$413	\$366
ZA3066F32	30 x 66 x 29.5-49.5	85	309	24.19	\$2788	\$2909	\$371	\$338
ZA3060F32	30 x 60 x 29.5-49.5	85	296	23.68	\$2709	\$2816	\$403	\$306

Standard with box/box/file pedestal on **left** and file/file pedestal on **right**. File drawer and lower box drawer lock. File pedestal locks. Height adjustable frame sold separately.

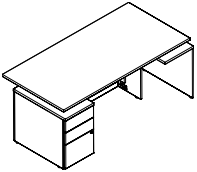

Height Adj. Desk - Single Pedestal

ZA3684F3S	36 x 84 x 29.5-49.5	85	325	26.68	\$2676	\$2843	\$482	\$514
ZA3672F3S	36 x 72 x 29.5-49.5	92.5	298	25.69	\$2639	\$2792	\$413	\$440
ZA3666F3S	36 x 66 x 29.5-49.5	92.5	284	25.18	\$2561	\$2700	\$371	\$403
ZA3660F3S	36 x 60 x 29.5-49.5	92.5	271	24.70	\$2463	\$2593	\$325	\$366
ZA3084F3S	30 x 84 x 29.5-49.5	85	310	25.69	\$2732	\$2881	\$482	\$426
ZA3072F3S	30 x 72 x 29.5-49.5	92.5	285	24.70	\$2588	\$2718	\$413	\$366
ZA3066F3S	30 x 66 x 29.5-49.5	92.5	272	24.19	\$2510	\$2631	\$371	\$338
ZA3060F3S	30 x 60 x 29.5-49.5	92.5	260	23.68	\$2431	\$2538	\$325	\$306

Standard with box/box/file pedestal on **left**. File drawer and lower box drawer lock. Height adjustable frame sold separately. Top is inset 1" on the right and 1" on the user side to provide finger pinch clearance.

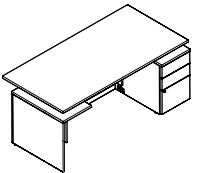

Height Adj. Desk - Single Pedestal

ZA3684FS3	36 x 84 x 29.5-49.5	85	325	26.68	\$2676	\$2843	\$482	\$514
ZA3672FS3	36 x 72 x 29.5-49.5	92.5	298	25.69	\$2639	\$2792	\$413	\$440
ZA3666FS3	36 x 66 x 29.5-49.5	92.5	284	25.18	\$2561	\$2700	\$371	\$403
ZA3660FS3	36 x 60 x 29.5-49.5	92.5	271	24.70	\$2463	\$2593	\$325	\$366
ZA3084FS3	30 x 84 x 29.5-49.5	85	310	25.69	\$2732	\$2881	\$482	\$426
ZA3072FS3	30 x 72 x 29.5-49.5	92.5	285	24.70	\$2588	\$2718	\$413	\$366
ZA3066FS3	30 x 66 x 29.5-49.5	92.5	272	24.19	\$2510	\$2631	\$371	\$338
ZA3060FS3	30 x 60 x 29.5-49.5	92.5	260	23.68	\$2431	\$2538	\$329	\$306

Standard with box/box/file pedestal on **right**. File drawer and lower box drawer lock. Height adjustable frame sold separately. Top is inset 1" on the left and 1" on the user side to provide finger pinch clearance.

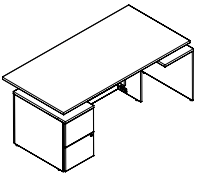

Height Adj. Desk - Single Pedestal

ZA3684F2S	36 x 84 x 29.5-49.5	85	323	26.68	\$2639	\$2806	\$482	\$514
ZA3672F2S	36 x 72 x 29.5-49.5	92.5	296	26.68	\$2602	\$2751	\$413	\$440
ZA3666F2S	36 x 66 x 29.5-49.5	92.5	282	25.18	\$2519	\$2658	\$371	\$403
ZA3660F2S	36 x 60 x 29.5-49.5	92.5	268	24.70	\$2426	\$2551	\$325	\$366
ZA3084F2S	30 x 84 x 29.5-49.5	92.5	308	25.69	\$2695	\$2844	\$482	\$426
ZA3072F2S	30 x 72 x 29.5-49.5	92.5	283	24.70	\$2551	\$2676	\$413	\$366
ZA3066F2S	30 x 66 x 29.5-49.5	92.5	270	24.19	\$2473	\$2589	\$371	\$338
ZA3060F2S	30 x 60 x 29.5-49.5	92.5	258	23.68	\$2394	\$2501	\$325	\$306

Standard with file/file pedestal on **left**. Pedestal locks. Height adjustable frame sold separately. Top is inset 1" on the right and 1" on the user side to provide finger pinch clearance.

Required Specifications

Top finish
Top/edge detail
Wire management finish
Must use with FFHATZS (sold separately)

Optional Specifications

HP laminate Handles
Key # Modesty finish glazed
Modesty Type
Grommet position or power block cut-out

Accessories

Power block
Pencil drawer

HEIGHT ADJUSTABLE DESKS

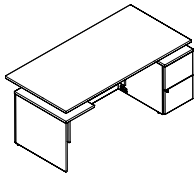

Height Adj. Desk - Single Pedestal**

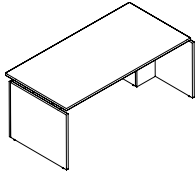

Height Adj. Desk - Faux Pedestals

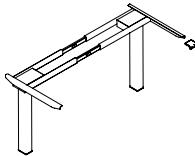

Height Adjustable Base*

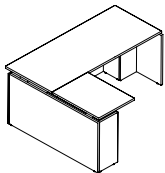

Right shown

L Desks

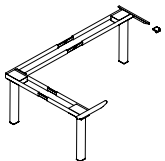

Height Adjustable Base*

MODEL#	DIMENSIONS D x W x H	FREIGHT CLASS	WT/LBS.	CUBIC FT.	1" TOP	1.5" TOP	GLAZE ADD	HP ADD
ZA3684FS2	36 x 84 x 29.5-49.5	85	323	26.68	\$2639	\$2806	\$482	\$514
ZA3672FS2	36 x 72 x 29.5-49.5	92.5	296	26.68	\$2602	\$2751	\$413	\$440
ZA3666FS2	36 x 66 x 29.5-49.5	92.5	282	25.18	\$2519	\$2658	\$371	\$403
ZA3660FS2	36 x 60 x 29.5-49.5	92.5	268	24.70	\$2426	\$2551	\$325	\$366
ZA3084FS2	30 x 84 x 29.5-49.5	92.5	308	25.69	\$2695	\$2844	\$482	\$426
ZA3072FS2	30 x 72 x 29.5-49.5	92.5	283	24.70	\$2551	\$2676	\$413	\$366
ZA3066FS2	30 x 66 x 29.5-49.5	92.5	270	24.19	\$2473	\$2589	\$371	\$338
ZA3060FS2	30 x 60 x 29.5-49.5	92.5	258	23.68	\$2394	\$2501	\$325	\$306

Standard with file/file pedestal on **right**. Pedestal locks. Height adjustable frame sold separately. Top is inset 1" on the left and 1" on the user side to provide finger pinch clearance.

ZA3684NP	36 x 84 x 29.5-49.5	70	231	10.48	\$1825	\$1997	N/A	\$514
ZA3672NP	36 x 72 x 29.5-49.5	125	206	27.69	\$1797	\$1946	N/A	\$440
ZA3666NP	36 x 66 x 29.5-49.5	65	198	8.47	\$1741	\$1880	N/A	\$403
ZA3660NP	36 x 60 x 29.5-49.5	65	198	8.47	\$1700	\$1825	N/A	\$366
ZA3072NP	30 x 72 x 29.5-49.5	70	188	8.71	\$1709	\$1839	N/A	\$366
ZA3066NP	30 x 66 x 29.5-49.5	70	178	7.96	\$1653	\$1774	N/A	\$338
ZA3060NP	30 x 60 x 29.5-49.5	70	168	7.49	\$1625	\$1732	N/A	\$306

Standard with two faux pedestals. Height adjustable frame sold separately. Top is inset 1" on the left, right and user side to provide finger pinch clearance.

FFHATZS	10 x -- x 26.8	70	50	2.97	\$1377	N/A	N/A	N/A
---------	----------------	----	----	------	--------	-----	-----	-----

For use with Zira height adjustable desks. Lifts 265 lbs. Each motor is mounted within the top of the column and will connect directly into one another without the need for a control box. Available in Black, Designer White or Tungsten.

- Specify **S** for use with 60" - 66" wide desks. Specify **M** for use with 72" - 84" wide desks.
- **Recommended torque range for installing all fasteners is 3-5 foot pounds and should not be exceeded. In addition, no impact drivers or high-torque equipment are to be used for any fasteners included in the table assembly kits, as this creates a high risk for damage that is not covered under warranty. The use of hand tools is highly recommended.**

ZA608424L	60 x 84 x 29.5-49.5	70	294	14.48	\$2408	\$2598	N/A	\$658
ZA607224L	60 x 72 x 29.5-49.5	70	273	13.24	\$2301	\$2473	N/A	\$584
ZA608424R	60 x 84 x 29.5-49.5	70	294	14.48	\$2408	\$2598	N/A	\$658
ZA607224R	60 x 72 x 29.5-49.5	70	273	13.24	\$2301	\$2473	N/A	\$584

Specify ZA60xx24L for **LEFT** or ZA60xx24R for **RIGHT**.

Frame sold separately. Top is inset 1" on the return side and 1/2" on the left and right side to provide finger pinch clearance.

- Accepts only 2-stage, 3-leg mechanisms for 22T in-foot.

FFHATZ9	10 x -- x 26.8	125	67	8.40	\$2000	N/A	N/A	N/A
---------	----------------	-----	----	------	--------	-----	-----	-----

For use with Zira height adjustable L desks. Lifts 265 lbs. Each motor is mounted within the top of the column and will connect directly into one another without the need for a control box. Available in Black, Designer White or Tungsten.

- **Recommended torque range for installing all fasteners is 3-5 foot pounds and should not be exceeded. In addition, no impact drivers or high-torque equipment are to be used for any fasteners included in the table assembly kits, as this creates a high risk for damage that is not covered under warranty. The use of hand tools is highly recommended.**

Required Specifications

Top finish Top/edge detail
Base finish*
Wire management finish
Must use with base (sold separately)

Optional Specifications

HP laminate Handles**
Key #*** Modesty finish glazed
Modesty Type
Grommet position or power block cut-out

Accessories

Power block Pencil drawer

MODESTY PANEL KIT

MODEL#	DIMENSIONS D x W x H	FREIGHT CLASS	WT/LBS.	CUBIC FT.	1" TOP	1.5" TOP	GLAZE ADD	HP ADD
ZA3084TB	29 x 82 x 16-16.5	85	99	6.75	\$815	\$1033	\$510	\$426
ZA3072TB	29 x 70 x 16-16.5	85	85	6	\$718	\$904	\$450	\$366
ZA3066TB	29 x 64 x 16-16.5	85	79	5.50	\$672	\$844	\$417	\$338
ZA3060TB	29 x 58 x 16-16.5	85	71	5	\$598	\$756	\$408	\$306
ZA3054TB	29 x 52 x 16-16.5	85	64	4.50	\$551	\$695	\$357	\$278
ZA3048TB	29 x 46 x 16-16.5	85	57	4	\$505	\$630	\$329	\$246
ZA3042TB	29 x 40 x 16-16.5	85	50	3.75	\$454	\$566	\$297	\$213
ZA2484TB	23 x 82 x 16-16.5	85	74	5	\$727	\$903	\$436	\$343
ZA2472TB	23 x 70 x 16-16.5	70	86	5.50	\$644	\$797	\$450	\$292
ZA2466TB	23 x 64 x 16-16.5	70	68	4.50	\$598	\$742	\$417	\$269
ZA2460TB	23 x 58 x 16-16.5	85	61	4.25	\$533	\$663	\$408	\$246
ZA2454TB	23 x 52 x 16-16.5	85	55	3.75	\$491	\$607	\$357	\$233
ZA2448TB	23 x 46 x 16-16.5	85	49	3.50	\$450	\$557	\$329	\$195
ZA2442TB	23 x 40 x 16-16.5	85	43	3	\$399	\$501	\$306	\$172

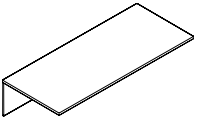

Top and Modesty Panel Kit

For use with height adjustable mechanisms. Height adjustable frame not included.

- Compatible with FreeFit + FOLI Height Adjustable Tables
- Cannot be used with FFHATZS or FFHATZ9

RETURNS COMPATIBLE W/HT ADJ. DESKS

MODEL#	DIMENSIONS	FREIGHT CLASS	WT/LBS.	CUBIC FT.	1" TOP	1.5" TOP	GLAZE ADD	HP ADD
Z2472L	24 x 72 x 29.5-30	65	144	6	\$660	\$775	N/A	\$287
Z2466L	24 x 66 x 29.5-30	65	135	6	\$660	\$760	N/A	\$287
Z2460L	24 x 60 x 29.5-30	65	125	5.25	\$598	\$685	N/A	\$264
Z2448L	24 x 48 x 29.5-30	65	106	4.30	\$545	\$620	N/A	\$210
Z2442L	24 x 42 x 29.5-30	65	95	3.80	\$545	\$611	N/A	\$176
Z2436L	24 x 36 x 29.5-30	65	86	3.30	\$477	\$531	N/A	\$132
Z2430L	24 x 30 x 29.5-30	70	77	3.60	\$450	\$492	N/A	\$132

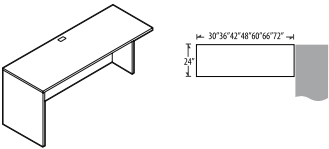

24" Deep Connectable Table - Left

Full end panel on left. Right narrow end panel connects to 24"D center/right connectable table, or at 90° angle to a freestanding table, height adjustable desk, 24"D extended corners or at the end of a straight run; "D" islands or "P" islands with "T" and "H" bases. Grommet in worksurface. Shipped RTA (ready to assemble).

- Units 48" and under require storage for stability
- Modesty Panel is 1" off of ground.

Z2472R	24 x 72 x 29.5-30	65	144	6	\$660	\$775	N/A	\$287
Z2466R	24 x 66 x 29.5-30	65	135	6	\$660	\$760	N/A	\$287
Z2460R	24 x 60 x 29.5-30	65	125	5.25	\$598	\$685	N/A	\$264
Z2448R	24 x 48 x 29.5-30	65	106	4.30	\$545	\$620	N/A	\$210
Z2442R	24 x 42 x 29.5-30	65	95	3.80	\$545	\$611	N/A	\$176
Z2436R	24 x 36 x 29.5-30	65	86	3.30	\$477	\$531	N/A	\$132
Z2430R	24 x 30 x 29.5-30	70	77	3.60	\$450	\$492	N/A	\$132

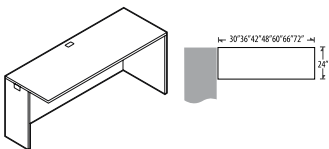

24" Deep Connectable Table - Right

Full end panel on right. Left narrow end panel connects to 24"D center/right connectable table, or at 90° angle to a freestanding table, height adjustable desk, 24"D extended corners or at the end of a straight run; "D" islands or "P" islands with "T" and "H" bases. Grommet in worksurface. Shipped RTA (ready to assemble).

- Units 48" and under require storage for stability
- Modesty Panel is 1" off of ground.

Required Specifications

- Top finish
- Top/edge detail
- Base finish
- Wire management finish

Optional Specifications

- HP laminate
- Grommet position or power block cut-out

Accessories

- Power block

BRIDGES COMPATIBLE W/ ZXXXXBBOL/R AND ZXXXXBLFL/R CREDENZAS DIMENSIONS FREIGHT CLASS WT/LBS. CUBIC FT. 1"TOP 1.5" TOP GLAZE ADD HP ADD

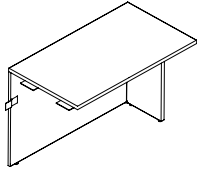

Bridge w/Full Laminate Modesty, Left

	D x W x H								
ZA2448RL	24 x 48 x 29.5-30	70	78	4.30	\$624	\$729	N/A	\$192	
ZA2442RL	24 x 42 x 29.5-30	70	66	3.80	\$543	\$635	N/A	\$171	
ZA2436RL	24 x 36 x 29.5-30	70	59	3.30	\$505	\$585	N/A	\$146	
ZA2048RL	20 x 48 x 29.5-30	70	72	4.30	\$595	\$685	N/A	\$163	
ZA2042RL	20 x 42 x 29.5-30	70	62	3.80	\$518	\$596	N/A	\$142	
ZA2036RL	20 x 36 x 29.5-30	70	56	3.30	\$483	\$551	N/A	\$122	

For use with height adjustable desks - single pedestal. Connects to credenza on **left**.

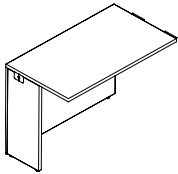

Bridge w/Full Laminate Modesty, Right

ZA2448RR	24 x 48 x 29.5-30	70	78	4.30	\$624	\$729	N/A	\$195	
ZA2442RR	24 x 42 x 29.5-30	70	66	3.80	\$543	\$635	N/A	\$171	
ZA2436RR	24 x 36 x 29.5-30	70	59	3.30	\$505	\$585	N/A	\$146	
ZA2048RR	20 x 48 x 29.5-30	70	72	4.30	\$595	\$685	N/A	\$163	
ZA2042RR	20 x 42 x 29.5-30	70	62	3.80	\$518	\$596	N/A	\$142	
ZA2036RR	20 x 36 x 29.5-30	70	56	3.30	\$483	\$551	N/A	\$122	

For use with height adjustable desks - single pedestal. Connects to credenza on **right**.

CREDENZAS COMPATIBLE W/HT ADJ. BRIDGES MODEL# DIMENSIONS FREIGHT CLASS WT/LBS. CUBIC FT. 1"TOP 1.5" TOP GLAZE ADD HP ADD

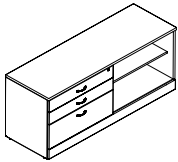

Credenza

Z2472BBOL	24 x 72 x 29.5-30	125	261	35.75	\$1856	\$1955	N/A	\$292	
Z2460BBOL	24 x 60 x 29.5-30	125	231	30	\$1666	\$1748	N/A	\$244	
Z2072BBOL	20 x 72 x 29.5-30	125	234	30.25	\$1773	\$1855	N/A	\$244	
Z2060BBOL	20 x 60 x 29.5-30	100	207	25.25	\$1610	\$1679	N/A	\$203	

Compatible with height adjustable bridges. Box/box/lateral file on **left** with open storage on the **right**. Connects to bridge on **right**.

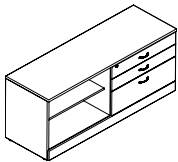

Credenza

Z2472BBOR	24 x 72 x 29.5-30	125	261	35.75	\$1856	\$1955	N/A	\$292	
Z2460BBOR	24 x 60 x 29.5-30	125	231	30	\$1666	\$1748	N/A	\$244	
Z2072BBOR	20 x 72 x 29.5-30	125	234	30.25	\$1773	\$1855	N/A	\$244	
Z2060BBOR	20 x 60 x 29.5-30	100	207	25.25	\$1610	\$1679	N/A	\$203	

Compatible with height adjustable bridges. Box/box/lateral file on **right** with open storage on the **left**. Connects to bridge on **left**.

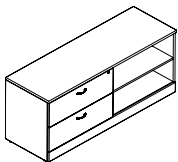

Credenza

Z2472BLFL	24 x 72 x 29.5-30	125	265	35.75	\$1828	\$1927	N/A	\$292	
Z2460BLFL	24 x 60 x 29.5-30	125	235	30	\$1648	\$1730	N/A	\$244	
Z2072BLFL	20 x 72 x 29.5-30	125	239	30.25	\$1745	\$1827	N/A	\$244	
Z2060BLFL	20 x 60 x 29.5-30	100	212	25.25	\$1588	\$1657	N/A	\$203	

Compatible with height adjustable bridges. Two drawer lateral file on **left** with open storage on the **right**. Connects to bridge on **right**.

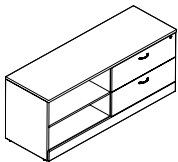

Credenza

Z2472BLFR	24 x 72 x 29.5-30	125	265	35.75	\$1828	\$1927	N/A	\$292	
Z2460BLFR	24 x 60 x 29.5-30	125	235	30	\$1648	\$1730	N/A	\$244	
Z2072BLFR	20 x 72 x 29.5-30	125	239	30.25	\$1745	\$1827	N/A	\$244	
Z2060BLFR	20 x 60 x 29.5-30	100	212	25.25	\$1588	\$1657	N/A	\$203	

Compatible with height adjustable bridges. Two drawer lateral file on **right** with open storage on the **left**. Connects to bridge on **left**.

Required Specifications

Top finish
Top/edge detail
Base finish

Optional Specifications

HP laminate
Modesty panel type
Grommet position or power block cut-out

Accessories

Power block
Keyboard
Pencil drawer

DOUBLE PEDESTAL DESKS

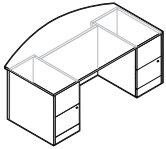

Double Pedestal Bow Top Desk

MODEL#	DIMENSIONS D x W x H	FREIGHT CLASS	WT./LBS.	CUBIC FT.	1" TOP	1.5" TOP	GLAZE ADD	HP ADD
Z4284FB22	42 x 84 x 29.5-30	250	381.15	102.5	\$2139	\$2378	\$689	\$762
Z4272FB22	42 x 72 x 29.5-30	125	377	59	\$2056	\$2265	\$570	\$572
Z3672FB22	36 x 72 x 29.5-30	125	317.10	50.75	\$1920	\$2105	\$570	\$430
Z3666FB22	36 x 66 x 29.5-30	125	305.55	46.75	\$1881	\$2052	\$509	\$430
Z3660FB22	36 x 60 x 29.5-30	125	295.05	42.50	\$1825	\$1982	\$450	\$358

Standard with **Freestanding** file/file pedestals on **left** and **right**. Pedestals lock. Bow top overhangs 2 ¼" at ends and 8" on center.

- 84" wide desks are shipped RTA (ready to assemble) in 3 cartons.

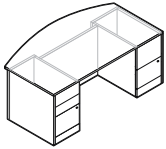

Double Pedestal Bow Top Desk

Z4284FB32	42 x 84 x 29.5-30	250	379.05	102.5	\$2167	\$2406	\$689	\$762
Z4272FB32	42 x 72 x 29.5-30	125	375	59	\$2083	\$2292	\$570	\$572
Z3672FB32	36 x 72 x 29.5-30	125	315	50.75	\$1945	\$2131	\$570	\$430
Z3666FB32	36 x 66 x 29.5-30	125	303.45	46.75	\$1907	\$2077	\$509	\$430
Z3660FB32	36 x 60 x 29.5-30	125	292.95	42.50	\$1854	\$2011	\$450	\$358

Standard with **Freestanding** file/file pedestal on **right** and box/box/file pedestal on **left**. File drawer and lower box drawer lock. File pedestal locks. Bow top overhangs 2 ¼" at ends and 8" on center.

- 84" wide desks are shipped RTA (ready to assemble) in 3 cartons.

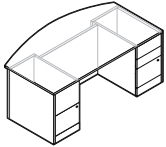

Double Pedestal Bow Top Desk

Z4284FB23	42 x 84 x 29.5-30	250	379.05	102.5	\$2167	\$2406	\$689	\$762
Z4272FB23	42 x 72 x 29.5-30	125	375	59	\$2083	\$2292	\$570	\$572
Z3672FB23	36 x 72 x 29.5-30	125	315	50.75	\$1945	\$2131	\$570	\$430
Z3666FB23	36 x 66 x 29.5-30	125	303.45	46.75	\$1907	\$2077	\$509	\$430
Z3660FB23	36 x 60 x 29.5-30	125	292.95	42.50	\$1854	\$2011	\$450	\$358

Standard with **Freestanding** file/file pedestal on **left** and box/box/file pedestal on **right**. File drawer and lower box drawer lock. File pedestal locks. Bow top overhangs 2 ¼" at ends and 8" on center.

- 84" wide desks are shipped RTA (ready to assemble) in 3 cartons.

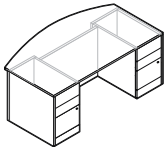

Double Pedestal Bow Top Desk

Z4284FB33	42 x 84 x 29.5-30	250	381.15	102.5	\$2194	\$2433	\$689	\$762
Z4272FB33	42 x 72 x 29.5-30	125	378	59	\$2110	\$2320	\$570	\$572
Z3672FB33	36 x 72 x 29.5-30	125	317.10	50.75	\$1973	\$2159	\$570	\$430
Z3666FB33	36 x 66 x 29.5-30	125	305.55	46.75	\$1935	\$2105	\$509	\$430
Z3660FB33	36 x 60 x 29.5-30	125	295.05	42.50	\$1886	\$2053	\$450	\$358

Standard with **Freestanding** box/box/file pedestals on **left** and **right**. File drawer and lower box drawer lock. Bow top overhangs 2 ¼" at ends and 8" on center.

- 84" wide desks are shipped RTA (ready to assemble) in 3 cartons.

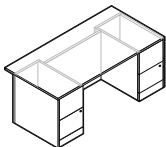

Double Pedestal Desk

Z4284F22	42 x 84 x 29.5-30	250	385.35	102.5	\$2064	\$2267	\$689	\$762
Z4272F22	42 x 72 x 29.5-30	125	373	59	\$1988	\$2163	\$570	\$572
Z3684F22	36 x 84 x 29.5-30	250	366.12	176.6	\$1943	\$2119	\$689	\$572
Z3672F22	36 x 72 x 29.5-30	125	326.01	50.75	\$1854	\$2007	\$570	\$430
Z3666F22	36 x 66 x 29.5-30	125	314.77	46.75	\$1819	\$1960	\$509	\$430
Z3660F22	36 x 60 x 29.5-30	125	294.93	42.50	\$1785	\$1913	\$450	\$358
Z3072F22	29.7 x 72 x 29.5-30	125	326.01	50.75	\$1854	\$2006	\$570	\$430
Z3066F22	29.7 x 66 x 29.5-30	125	314.77	46.75	\$1819	\$1959	\$509	\$430
Z3060F22	29.7 x 60 x 29.5-30	125	294.93	42.50	\$1785	\$1912	\$450	\$358

Standard with **Freestanding** file/file pedestals on **left** and **right**. Pedestals lock.

- 84" wide desks are shipped RTA (ready to assemble) in 3 cartons.
- Hutches may not be placed on this desk

Required Specifications

Top finish
Top/edge detail
Base finish
Lock finish

Optional Specifications

HP laminate
Key #
Modesty Type
Modesty finish glazed
Modesty Type
Grommet position or power block cut-out

Accessories

Power block
Keyboard
Pencil drawer

DOUBLE PEDESTAL DESKS

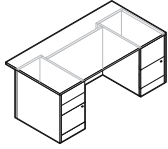

Double Pedestal Desk

MODEL#	DIMENSIONS D x W x H	FREIGHT CLASS	WT/LBS.	CUBIC FT.	1"TOP	1.5" TOP	GLAZE ADD	HP ADD
Z4284F32	42 x 84 x 29.5-30	250	383.25	102.5	\$2091	\$2292	\$689	\$762
Z4272F32	42 x 72 x 29.5-30	125	371	59	\$2015	\$2190	\$570	\$572
Z3684F32	36 x 84 x 29.5-30	250	364.54	176.6	\$1970	\$2146	\$689	\$572
Z3672F32	36 x 72 x 29.5-30	125	324.43	50.75	\$1882	\$2035	\$570	\$430
Z3666F32	36 x 66 x 29.5-30	125	313.18	46.75	\$1847	\$1988	\$509	\$430
Z3660F32	36 x 60 x 29.5-30	125	267.10	42.50	\$1812	\$1941	\$450	\$358
Z3072F32	29.69 x 72 x 29.5-30	125	324.43	50.75	\$1882	\$2035	\$570	\$430
Z3066F32	29.7 x 66 x 29.5-30	125	313.18	46.75	\$1847	\$1988	\$509	\$430
Z3060F32	29.7 x 60 x 29.5-30	125	267.10	42.50	\$1812	\$1940	\$450	\$358

Standard with **Freestanding** box/box/file pedestal on **left** and file/file pedestal on **right**. File drawer and lower box drawer lock. File pedestal locks.

- 84" wide desks are shipped RTA (ready to assemble) in 3 cartons.
- Hutches may not be placed on this desk

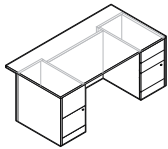

Double Pedestal Desk

Z4284F23	42 x 84 x 29.5-30	250	383.25	102.5	\$2091	\$2292	\$689	\$762
Z4272F23	42 x 72 x 29.5-30	125	371	59	\$2015	\$2190	\$570	\$572
Z3684F23	36 x 84 x 29.5-30	250	364.54	176.6	\$1970	\$2146	\$689	\$572
Z3672F23	36 x 72 x 29.5-30	125	324.43	50.75	\$1882	\$2035	\$570	\$430
Z3666F23	36 x 66 x 29.5-30	125	313.18	46.75	\$1847	\$1988	\$509	\$430
Z3660F23	36 x 60 x 29.5-30	125	267.10	42.50	\$1812	\$1941	\$450	\$358
Z3072F23	29.7 x 72 x 29.5-30	125	324.43	50.75	\$1882	\$2035	\$570	\$430
Z3066F23	29.7 x 66 x 29.5-30	125	313.18	46.75	\$1847	\$1988	\$509	\$430
Z3060F23	29.7 x 60 x 29.5-30	125	267.10	42.50	\$1812	\$1940	\$450	\$358

Standard with **Freestanding** file/file pedestal on **left** and box/box/file pedestal on **right**. File drawer and lower box drawer lock. File pedestal locks.

- 84" wide desks are shipped RTA (ready to assemble) in 3 cartons.
- Hutches may not be placed on this desk

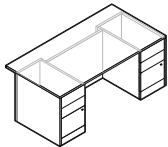

Double Pedestal Desk

Z4284F33	42 x 84 x 29.5-30	250	381.15	102.5	\$2119	\$2320	\$689	\$762
Z4272F33	42 x 72 x 29.5-30	125	370	59	\$2043	\$2217	\$570	\$572
Z3684F33	36 x 84 x 29.5-30	300	341.25	176.6	\$1998	\$2174	\$689	\$572
Z3672F33	36 x 72 x 29.5-30	125	316.05	50.75	\$1908	\$2061	\$570	\$430
Z3666F33	36 x 66 x 29.5-30	125	304.50	46.75	\$1874	\$2015	\$509	\$430
Z3660F33	36 x 60 x 29.5-30	125	261.45	42.50	\$1839	\$1968	\$450	\$358
Z3072F33	29.7 x 72 x 29.5-30	125	316.05	50.75	\$1908	\$2061	\$570	\$430
Z3066F33	29.7 x 66 x 29.5-30	125	304.50	46.75	\$1874	\$2010	\$509	\$430
Z3060F33	29.69 x 60 x 29.5-30	125	261.45	42.50	\$1839	\$1968	\$450	\$358

Standard with **Freestanding** box/box/file pedestals on **left** and **right**. File drawer and lower box drawer lock.

- 84" wide desks are shipped RTA (ready to assemble) in 3 cartons.
- Hutches may not be placed on this desk

Required Specifications

Top finish
Top/edge detail
Base finish
Lock finish

Optional Specifications

HP laminate
Key #
Modesty Type
Grommet position or power block cut-out
Handles
Modesty finish glazed

Accessories

Power block
Keyboard
Pencil drawer

SINGLE PEDESTAL DESKS

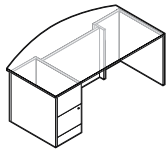

Single Pedestal Bow Top Desk - LEFT

MODEL#	DIMENSIONS D x W x H	FREIGHT CLASS	WT/LBS.	CUBIC FT.	1" TOP	1.5" TOP	GLAZE ADD	HP ADD
Z4284FB2L	42 x 84 x 29.5-30	125	322.35	43.50	\$1636	\$1875	\$689	\$762
Z4272FB2L	42 x 72 x 29.5-30	150	315	59	\$1552	\$1762	\$570	\$572
Z3672FB2L	36 x 72 x 29.5-30	150	281.35	50.75	\$1439	\$1624	\$570	\$430
Z3666FB2L	36 x 66 x 29.5-30	150	274.68	46.75	\$1400	\$1571	\$509	\$430
Z3660FB2L	36 x 60 x 29.5-30	125	259.86	42.50	\$1347	\$1504	\$450	\$358

Standard with **Freestanding** file/file pedestal on **left** and faux pedestal **right**. Pedestal locks. Bow top overhangs 2 ¼" at ends and 8" on center.

- 84" wide desks are shipped RTA (ready to assemble) in 2 cartons.

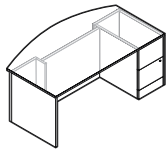

Single Pedestal Bow Top Desk - RIGHT

Z4284FB2R	42 x 84 x 29.5-30	125	322.35	43.50	\$1636	\$1875	\$689	\$762
Z4272FB2R	42 x 72 x 29.5-30	150	315	59	\$1552	\$1762	\$570	\$572
Z3672FB2R	36 x 72 x 29.5-30	150	281.35	50.75	\$1439	\$1624	\$570	\$430
Z3666FB2R	36 x 66 x 29.5-30	150	274.68	46.75	\$1400	\$1571	\$509	\$430
Z3660FB2R	36 x 60 x 29.5-30	125	259.86	42.50	\$1347	\$1504	\$450	\$358

Standard with **Freestanding** faux pedestal **left** and file/file pedestal on **right**. Pedestal locks. Bow top overhangs 2 ¼" at ends and 8" on center.

- 84" wide desks are shipped RTA (ready to assemble) in 2 cartons.

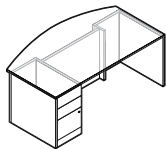

Single Pedestal Bow Top Desk - LEFT

Z4284FB3L	42 x 84 x 29.5-30	125	320.25	43.50	\$1664	\$1902	\$689	\$762
Z4272FB3L	42 x 72 x 29.5-30	150	313	59	\$1579	\$1788	\$570	\$572
Z3672FB3L	36 x 72 x 29.5-30	150	279.77	50.75	\$1466	\$1652	\$570	\$430
Z3666FB3L	36 x 66 x 29.5-30	150	273.10	46.75	\$1429	\$1599	\$509	\$430
Z3660FB3L	36 x 60 x 29.5-30	125	258.27	42.50	\$1390	\$1549	\$450	\$358

Standard with **Freestanding** box/box/file pedestal on **left** and faux pedestal **right**. File drawer and lower box drawer lock. Bow top overhangs 2 ¼" at ends and 8" on center.

- 84" wide desks are shipped RTA (ready to assemble) in 2 cartons.

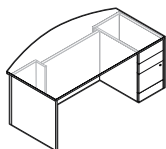

Single Pedestal Bow Top Desk - RIGHT

Z4284FB3R	42 x 84 x 29.5-30	125	320.25	43.50	\$1664	\$1902	\$689	\$762
Z4272FB3R	42 x 72 x 29.5-30	150	313	59	\$1579	\$1788	\$570	\$572
Z3672FB3R	36 x 72 x 29.5-30	150	279.77	50.75	\$1466	\$1652	\$570	\$430
Z3666FB3R	36 x 66 x 29.5-30	150	273.10	46.75	\$1429	\$1599	\$509	\$430
Z3660FB3R	36 x 60 x 29.5-30	125	258.27	42.50	\$1390	\$1549	\$450	\$358

Standard with **Freestanding** faux pedestal **left** and box/box/file pedestal on **right**. File drawer and lower box drawer lock. Bow top overhangs 2 ¼" at ends and 8" on center.

- 84" wide desks are shipped RTA (ready to assemble) in 2 cartons.

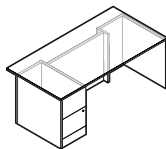

Single Pedestal Desk - LEFT

Z4284F2L	42 x 84 x 29.5-30	125	326.55	43.50	\$1560	\$1763	\$689	\$762
Z4272F2L	42 x 72 x 29.5-30	150	327	59	\$1484	\$1659	\$570	\$572
Z3684F2L	36 x 84 x 29.5-30	250	290.85	118	\$1464	\$1640	\$689	\$572
Z3672F2L	36 x 72 x 29.5-30	150	265.65	50.75	\$1373	\$1526	\$570	\$430
Z3666F2L	36 x 66 x 29.5-30	150	254.10	46.75	\$1339	\$1480	\$509	\$430
Z3660F2L	36 x 60 x 29.5-30	150	243.60	42.50	\$1306	\$1436	\$450	\$358
Z3072F2L	29.69 x 72 x 29.5-30	150	265.65	50.75	\$1373	\$1526	\$570	\$430
Z3066F2L	29.7 x 66 x 29.5-30	150	254.10	46.75	\$1339	\$1479	\$509	\$430
Z3060F2L	29.7 x 60 x 29.5-30	150	243.60	42.50	\$1306	\$1436	\$450	\$358

Standard with **Freestanding** file/file pedestal on **left** and faux pedestal **right**. Pedestal locks.

- 84" wide desks are shipped RTA (ready to assemble) in 2 cartons.
- Hutches may not be placed on this desk

Required Specifications

Top finish
Top/edge detail
Base finish
Lock finish

Optional Specifications

HP laminate Handles
Key # Modesty finish glazed
Modesty Type
Grommet position or power block cut-out

Accessories

Power block
Keyboard
Pencil drawer

SINGLE PEDESTAL DESKS

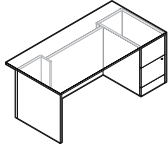

Single Pedestal Desk - RIGHT

MODEL#	DIMENSIONS	FREIGHT CLASS	WT/LBS.	CUBIC FT.	1"TOP	1.5" TOP	GLAZE ADD	HP ADD
D x W x H								
Z4284F2R	42 x 84 x 29.5-30	125	326.55	43.50	\$1560	\$1763	\$689	\$762
Z4272F2R	42 x 72 x 29.5-30	150	327	59	\$1484	\$1659	\$570	\$572
Z3684F2R	36 x 84 x 29.5-30	250	290.85	118	\$1464	\$1640	\$689	\$572
Z3672F2R	36 x 72 x 29.5-30	150	265.65	50.75	\$1373	\$1526	\$570	\$430
Z3666F2R	36 x 66 x 29.5-30	150	254.10	46.75	\$1339	\$1480	\$509	\$430
Z3660F2R	36 x 60 x 29.5-30	150	243.60	42.50	\$1306	\$1436	\$450	\$358
Z3072F2R	29.7 x 72 x 29.5-30	150	265.65	50.75	\$1373	\$1526	\$570	\$430
Z3066F2R	29.7 x 66 x 29.5-30	150	254.10	46.75	\$1339	\$1479	\$509	\$430
Z3060F2R	29.7 x 60 x 29.5-30	150	243.60	42.50	\$1306	\$1436	\$450	\$358

Standard with **Freestanding** faux pedestal on **left** and file/file pedestal **right**. Pedestal locks.

- 84" wide desks are shipped RTA (ready to assemble) in 2 cartons.
- Hutches may not be placed on this desk

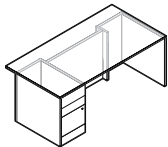

Single Pedestal Desk - LEFT*

Z4284F3L	42 x 84 x 29.5-30	125	324.45	43.50	\$1588	\$1789	\$689	\$762
Z4272F3L	42 x 72 x 29.5-30	150	324	59	\$1512	\$1687	\$570	\$572
Z3684F3L	36 x 84 x 29.5-30	250	288.75	118	\$1464	\$1640	\$689	\$572
Z3672F3L	36 x 72 x 29.5-30	150	263.55	50.75	\$1401	\$1554	\$570	\$430
Z3666F3L	36 x 66 x 29.5-30	150	252	46.75	\$1367	\$1508	\$509	\$430
Z3660F3L	36 x 60 x 29.5-30	150	241.50	42.50	\$1316	\$1444	\$450	\$358
Z3072F3L	29.7 x 72 x 29.5-30	150	253.55	50.75	\$1401	\$1554	\$570	\$430
Z3066F3L	29.7 x 66 x 29.5-30	150	252	46.75	\$1367	\$1507	\$509	\$430
Z3060F3L	29.7 x 60 x 29.5-30	150	241.50	42.50	\$1316	\$1444	\$450	\$358

Standard with **Freestanding** box/box/file pedestal on **left** and faux pedestal **right**. File drawer and lower box drawer lock.

- 84" wide desks are shipped RTA (ready to assemble) in 2 cartons.
- Hutches may not be placed on this desk

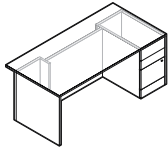

Single Pedestal Desk - RIGHT*

Z4284F3R	42 x 84 x 29.5-30	125	324.45	43.50	\$1588	\$1789	\$689	\$762
Z4272F3R	42 x 72 x 29.5-30	150	324	59	\$1512	\$1687	\$570	\$572
Z3684F3R	36 x 84 x 29.5-30	250	288.75	118	\$1464	\$1640	\$689	\$572
Z3672F3R	36 x 72 x 29.5-30	150	263.55	50.75	\$1401	\$1554	\$570	\$430
Z3666F3R	36 x 66 x 29.5-30	150	252	46.75	\$1367	\$1508	\$509	\$430
Z3660F3R	36 x 60 x 29.5-30	150	241.50	42.50	\$1316	\$1444	\$450	\$358
Z3072F3R	29.7 x 72 x 29.5-30	150	263.55	50.75	\$1401	\$1554	\$570	\$430
Z3066F3R	29.7 x 66 x 29.5-30	150	252	46.75	\$1367	\$1507	\$509	\$430
Z3060F3R	29.7 x 60 x 29.5-30	150	241.50	42.50	\$1316	\$1444	\$450	\$358

Standard with **Freestanding** faux pedestal on **left** and box/box/file pedestal **right**. File drawer and lower box drawer lock.

- 84" wide desks are shipped RTA (ready to assemble) in 2 cartons.
- Hutches may not be placed on this desk

Required Specifications

Top finish
Top/edge detail
Base finish
Lock finish

Optional Specifications

HP laminate
Key #
Modesty Type
Grommet position or power block cut-out

Handles
Modesty finish glazed

Accessories

Power block
Keyboard
Pencil drawer

FREESTANDING DESKS

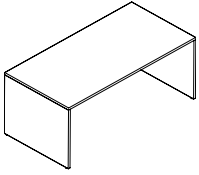

Freestanding Desk

MODEL#	DIMENSIONS D x W x H	FREIGHT CLASS	WT/LBS.	CUBIC FT.	1" TOP	1.5" TOP	GLAZE ADD	HP ADD
Z3684DK	36 x 84 x 29.5-30	70	168	8.25	\$931	\$1121	\$719	\$511
Z3672DK	36 x 72 x 29.5-30	70	152	7.25	\$852	\$1019	\$641	\$438
Z3666DK	36 x 66 x 29.5-30	70	144	6.75	\$815	\$968	\$586	\$402
Z3660DK	36 x 60 x 29.5-30	65	137	6	\$778	\$917	\$547	\$365
Z3072DK	30 x 72 x 29.5-30	70	130	6.25	\$760	\$899	\$641	\$365
Z3066DK	30 x 66 x 29.5-30	70	123	5.75	\$723	\$862	\$586	\$335
Z3060DK	30 x 60 x 29.5-30	70	117	5.25	\$686	\$825	\$547	\$304

Two full laminate end panels. 12"H laminate modesty panel.

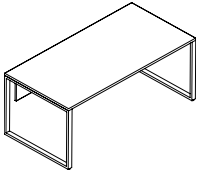

Freestanding Desk - Metal Legs*

Z3684DM	36 x 84 x 29.5-30	100	167	18.44	\$1991	\$2186	\$550	\$511
Z3672DM	36 x 72 x 29.5-30	100	151	17.46	\$1917	\$2084	\$473	\$438
Z3666DM	36 x 66 x 29.5-30	100	143	16.95	\$1880	\$2033	\$417	\$402
Z3660DM	36 x 60 x 29.5-30	100	143	16.95	\$1880	\$2033	\$378	\$365
Z3072DM	30 x 72 x 29.5-30	100	133	14.70	\$1825	\$1964	\$473	\$365
Z3066DM	30 x 66 x 29.5-30	100	126	14.22	\$1788	\$1927	\$417	\$335
Z3060DM	30 x 60 x 29.5-30	100	120	13.95	\$1750	\$1889	\$378	\$304

Double metal legs. 12"H laminate modesty panel.

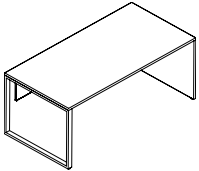

Freestanding Desk - Metal Legs*

Z3684DML	36 x 84 x 29.5-30	85	167	13.50	\$1463	\$1653	\$631	\$511
Z3672DML	36 x 72 x 29.5-30	85	151	12.04	\$1389	\$1552	\$554	\$438
Z3666DML	36 x 66 x 29.5-30	85	144	11.74	\$1352	\$1505	\$498	\$402
Z3660DML	36 x 60 x 29.5-30	85	135	11.24	\$1315	\$1454	\$460	\$365
Z3072DML	30 x 72 x 29.5-30	85	131	10.50	\$1297	\$1436	\$554	\$365
Z3066DML	30 x 66 x 29.5-30	85	125	10	\$1260	\$1399	\$498	\$335
Z3060DML	30 x 60 x 29.5-30	85	118	9.50	\$1223	\$1362	\$460	\$304

Single metal leg on **left** and laminate end panel on **right**. 12"H laminate modesty panel.

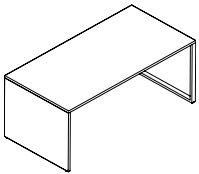

Freestanding Desk - Metal Legs*

Z3684DMR	36 x 84 x 29.5-30	85	167	13.50	\$1463	\$1653	\$631	\$511
Z3672DMR	36 x 72 x 29.5-30	85	151	12.04	\$1389	\$1552	\$554	\$438
Z3666DMR	36 x 66 x 29.5-30	85	144	11.74	\$1352	\$1505	\$498	\$402
Z3660DMR	36 x 60 x 29.5-30	85	135	11.24	\$1315	\$1454	\$460	\$365
Z3072DMR	30 x 72 x 29.5-30	85	131	10.50	\$1297	\$1436	\$554	\$365
Z3066DMR	30 x 66 x 29.5-30	85	125	10	\$1260	\$1399	\$498	\$335
Z3060DMR	30 x 60 x 29.5-30	85	118	9.50	\$1223	\$1362	\$460	\$304

Single metal leg on **right** and laminate end panel on **left**. 12"H laminate modesty panel.

Required Specifications

Top finish
Top/edge detail
Base finish
Leg finish*

Optional Specifications

HP laminate
Modesty finish glazed
Modesty type
Grommet position or power block cut-out

Accessories

Power block
Keyboard
Pencil drawer

TRANSITIONAL TABLES

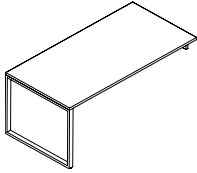

LEFT

Overlapping Table

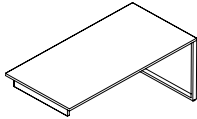

RIGHT

Overlapping Table

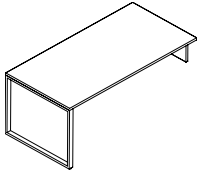

LEFT

Overlapping Table

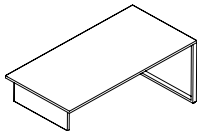

RIGHT

Overlapping Table

MODEL#	DIMENSIONS	FREIGHT CLASS	WT/LBS.	CUBIC FT.	1" TOP	1.5" TOP	GLAZE ADD	HP ADD	
D x W x H									
Z3684OML	36 x 84 x 29.5-30	100	132	13.50	\$1338	\$1528	N/A	\$511	
Z3672OML	36 x 72 x 29.5-30	100	120	12.24	\$1278	\$1468	N/A	\$438	
Z3666OML	36 x 66 x 29.5-30	100	112	11.74	\$1250	\$1440	N/A	\$402	
Z3660OML	36 x 60 x 29.5-30	100	105	11.24	\$1227	\$1413	N/A	\$365	
Z3072OML	30 x 72 x 29.5-30	100	104	10.50	\$1209	\$1390	N/A	\$365	
Z3066OML	30 x 66 x 29.5-30	100	97	10	\$1181	\$1367	N/A	\$335	
Z3060OML	30 x 60 x 29.5-30	100	90	9.50	\$1158	\$1344	N/A	\$304	

Metal open frame leg with support channels on **left**. To be placed on top of 23.75"/24.25" high units. Not freestanding.

Z3684OMR	36 x 84 x 29.5-30	100	132	13.50	\$1338	\$1528	N/A	\$511
Z3672OMR	36 x 72 x 29.5-30	100	120	12.24	\$1278	\$1468	N/A	\$438
Z3666OMR	36 x 66 x 29.5-30	100	112	11.74	\$1250	\$1440	N/A	\$402
Z3660OMR	36 x 60 x 29.5-30	100	105	11.24	\$1227	\$1413	N/A	\$365
Z3072OMR	30 x 72 x 29.5-30	100	104	10.50	\$1209	\$1390	N/A	\$365
Z3066OMR	30 x 66 x 29.5-30	100	97	10	\$1181	\$1367	N/A	\$335
Z3060OMR	30 x 60 x 29.5-30	100	90	9.50	\$1158	\$1344	N/A	\$304

Metal open frame leg with support channels on **right**. To be placed on top of 23.75"/24.25" high units. Not freestanding.

Z3684SOL	36 x 84 x 29.5-30	92.5	139	13.50	\$1352	\$1542	N/A	\$511
Z3672SOL	36 x 72 x 29.5-30	92.5	126	12.24	\$1292	\$1482	N/A	\$438
Z3666SOL	36 x 66 x 29.5-30	92.5	118	11.74	\$1264	\$1454	N/A	\$402
Z3660SOL	36 x 60 x 29.5-30	100	110	11.24	\$1241	\$1427	N/A	\$365
Z3072SOL	30 x 72 x 29.5-30	92.5	108	10.50	\$1223	\$1404	N/A	\$365
Z3066SOL	30 x 66 x 29.5-30	92.5	100	10	\$1195	\$1381	N/A	\$335
Z3060SOL	30 x 60 x 29.5-30	92.5	96	9.50	\$1172	\$1358	N/A	\$304

Metal open frame leg with support channels on **left**. To be placed on top of 17.87"/18.37" high units. Not freestanding.

Z3684SOR	36 x 84 x 29.5-30	92.5	139	13.50	\$1352	\$1542	N/A	\$511
Z3672SOR	36 x 72 x 29.5-30	92.5	126	12.24	\$1292	\$1482	N/A	\$438
Z3666SOR	36 x 66 x 29.5-30	92.5	118	11.74	\$1264	\$1454	N/A	\$402
Z3660SOR	36 x 60 x 29.5-30	100	110	11.24	\$1241	\$1427	N/A	\$365
Z3072SOR	30 x 72 x 29.5-30	92.5	108	10.50	\$1223	\$1404	N/A	\$365
Z3066SOR	30 x 66 x 29.5-30	92.5	100	10	\$1195	\$1381	N/A	\$335
Z3060SOR	30 x 60 x 29.5-30	92.5	96	9.50	\$1172	\$1358	N/A	\$304

Metal open frame leg with support channels on **right**. To be placed on top of 17.87"/18.37" high units. Not freestanding.

Required Specifications

- Top finish
- Top/edge detail
- Base finish
- Leg finish

Optional Specifications

- HP laminate
- Grommet position or power block cut-out

Accessories

- Power block
- Keyboard
- Pencil drawer

FLUSH RETURNS

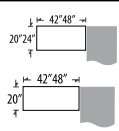
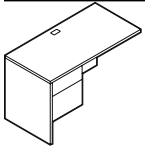

Flush Return - LEFT

MODEL#	DIMENSIONS D x W x H	FREIGHT CLASS	WT./LBS.	CUBIC FT.	1" TOP	1.5" TOP	GLAZE ADD	HP ADD
Z2448FL	24 x 48 x 29.5-30	125	155	24	\$762	\$837	N/A	\$210
Z2442FL	24 x 42 x 29.5-30	125	144	21.25	\$762	\$828	N/A	\$176
Z2048FL	20 x 48 x 29.5-30	125	140	20.25	\$707	\$773	N/A	\$176
Z2042FL	20 x 42 x 29.5-30	125	130	18	\$707	\$773	N/A	\$176

Standard with **box/file** drawer pedestal. One pencil tray. Pedestal locks. Grommet in worksurface. Pedestal is on the **left**. For use with right handed single pedestal desks, 20"/24" deep extended corners with narrow end panel or 20"/24" deep five-sided corners with narrow end panel.

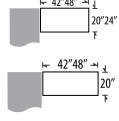
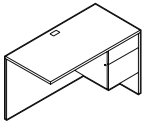

Flush Return - RIGHT

Z2448FR	24 x 48 x 29.5-30	125	155	24	\$762	\$837	N/A	\$210
Z2442FR	24 x 42 x 29.5-30	125	144	21.25	\$762	\$828	N/A	\$176
Z2048FR	20 x 48 x 29.5-30	125	140	20.25	\$707	\$773	N/A	\$176
Z2042FR	20 x 42 x 29.5-30	125	130	18	\$707	\$773	N/A	\$176

Standard with **box/file** drawer pedestal. One pencil tray. Pedestal locks. Grommet in worksurface. Pedestal is on the **right**. For use with right handed single pedestal desks, 20"/24" deep extended corners with narrow end panel or 20"/24" deep five-sided corners with narrow end panel.

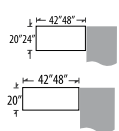
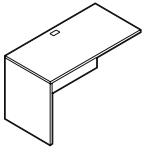

Flush Return - LEFT*

Z2448EL	24 x 48 x 29.5-30	65	107	4.30	\$539	\$614	N/A	\$210
Z2442EL	24 x 42 x 29.5-30	65	96	3.80	\$539	\$605	N/A	\$176
Z2048EL	20 x 48 x 29.5-30	65	97	4.30	\$497	\$564	N/A	\$176
Z2042EL	20 x 42 x 29.5-30	65	86	3.80	\$497	\$564	N/A	\$176

Return has **no pedestal**. Grommet in worksurface. For use with right handed single pedestal desks, 20"/24" deep extended corners with narrow end panel or 20"/24" deep five-sided corners with narrow end panel.

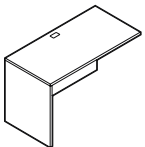

Flush Return - LEFT

Z1672RL	15.8 x 72 x 29.5-30	70	109.20	6	\$536	\$628	N/A	\$216
Z1666RL	15.8 x 66 x 29.5-30	70	101.85	5.75	\$513	\$599	N/A	\$216
Z1660RL	15.8 x 60 x 29.5-30	70	94.50	5.25	\$484	\$563	N/A	\$180
Z1654RL	15.8 x 54 x 29.5-30	70	87.15	5.25	\$458	\$531	N/A	\$180
Z1648RL	15.8 x 48 x 29.5-30	70	79.80	4.25	\$421	\$486	N/A	\$145
Z1642RL	15.8 x 42 x 29.5-30	70	70.35	4	\$377	\$436	N/A	\$145
Z1636RL	15.8 x 36 x 29.5-30	70	61.95	3.50	\$337	\$390	N/A	\$109

16" Throat. Return has **no pedestal**. Grommet in worksurface. Shipped RTA (ready to assemble). For use with extended corners, desks and islands with 16" throat.

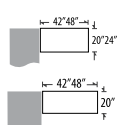
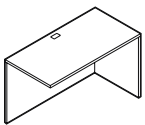

Flush Return - RIGHT**

Z2448ER	24 x 48 x 29.5-30	65	107	4.30	\$539	\$614	N/A	\$210
Z2442ER	24 x 42 x 29.5-30	65	96	3.80	\$539	\$605	N/A	\$176
Z2048ER	20 x 48 x 29.5-30	65	97	4.30	\$497	\$564	N/A	\$176
Z2042ER	20 x 42 x 29.5-30	65	86	3.80	\$497	\$564	N/A	\$176

Return has **no pedestal**. Grommet in worksurface. Shipped RTA (ready to assemble). For use with right handed single pedestal desks, 20"/24" deep extended corners with narrow end panel or 20"/24" deep five-sided corners with narrow end panel.

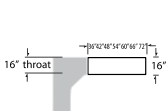
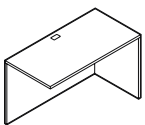

Flush Return - RIGHT

Z1672RR	15.8 x 72 x 29.5-30	70	109.20	6	\$536	\$628	N/A	\$216
Z1666RR	15.8 x 66 x 29.5-30	70	101.85	5.75	\$513	\$599	N/A	\$216
Z1660RR	15.8 x 60 x 29.5-30	70	94.50	5.25	\$484	\$563	N/A	\$180
Z1654RR	15.8 x 54 x 29.5-30	70	87.15	5.25	\$458	\$531	N/A	\$180
Z1648RR	15.8 x 48 x 29.5-30	70	79.80	4.25	\$421	\$486	N/A	\$145
Z1642RR	15.8 x 42 x 29.5-30	70	70.35	4	\$377	\$436	N/A	\$145
Z1636RR	15.8 x 36 x 29.5-30	70	61.95	3.50	\$337	\$390	N/A	\$109

16" Throat. Return has **no pedestal**. Grommet in worksurface. Shipped RTA (ready to assemble). For use with extended corners, desks and islands with 16" throat.

Required Specifications

- Top finish
- Top/edge detail
- Base finish
- Lock finish

Optional Specifications

- HP laminate
- Handles
- Key #
- Modesty Type
- Grommet position or power block cut-out

Accessories

- Power block
- Keyboard
- Pencil drawer

SPACE SAVER RETURNS

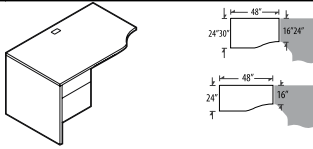

Space Saver Return - LEFT*

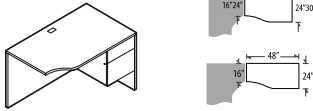

Space Saver Return - RIGHT*

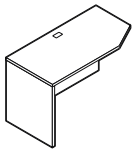

Space Saver Return - LEFT

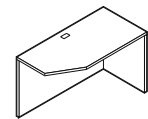
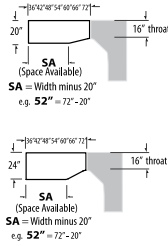

Space Saver Return - RIGHT

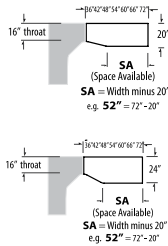

MODEL#	DIMENSIONS	FREIGHT CLASS	WT/LBS.	CUBIC FT.	1\"/>			
Z3048FSL	29.69 x 48 x 29.5-30	150	166	29	\$837	\$938	N/A	\$303
Z2448FSL	24 x 48 x 29.5-30	125	154	24.25	\$847	\$937	N/A	\$192

Standard with **box/file** drawer pedestal. Grommet in worksurface. One pencil tray. Pedestal locks. Connects to 24" or 16" component.

Z3048FSR	29.69 x 48 x 29.5-30	150	166	29	\$837	\$938	N/A	\$303
Z2448FSR	24 x 48 x 29.5-30	125	154	24.25	\$847	\$937	N/A	\$192

Standard with **box/file** drawer pedestal. Grommet in worksurface. One pencil tray. Pedestal locks. Connects to 24" or 16" component.

Z247216RL	24 x 72 x 29.5-30	65	135.45	6	\$637	\$774	N/A	\$287
Z246616RL	24 x 66 x 29.5-30	70	127.05	5.75	\$609	\$735	N/A	\$287
Z246016RL	24 x 60 x 29.5-30	70	117.60	5.25	\$571	\$688	N/A	\$238
Z245416RL	24 x 54 x 29.5-30	70	108.15	5.25	\$539	\$646	N/A	\$238
Z244816RL	24 x 48 x 29.5-30	65	99.75	4.25	\$494	\$590	N/A	\$192
Z244216RL	24 x 42 x 29.5-30	70	88.20	4	\$443	\$529	N/A	\$192
Z243616RL	24 x 36 x 29.5-30	70	77.70	3.50	\$401	\$478	N/A	\$145
Z207216RL	20 x 72 x 29.5-30	70	122.85	6	\$583	\$698	N/A	\$287
Z206616RL	20 x 66 x 29.5-30	70	114.45	5.75	\$556	\$661	N/A	\$287
Z206016RL	20 x 60 x 29.5-30	70	106.05	5.25	\$522	\$619	N/A	\$238
Z205416RL	20 x 54 x 29.5-30	70	97.65	5.25	\$491	\$579	N/A	\$238
Z204816RL	20 x 48 x 29.5-30	70	90.30	4.25	\$452	\$532	N/A	\$192
Z204216RL	20 x 42 x 29.5-30	70	79.80	4	\$405	\$478	N/A	\$192
Z203616RL	20 x 36 x 29.5-30	70	70.35	3.50	\$365	\$427	N/A	\$145

16" Throat. Return has **no pedestal**. Grommet in worksurface. Shipped RTA (ready to assemble). For use with extended corners, desks and islands with 16"throat. Accepts same depth storage shells under worksurface, see pages **xxxx**.

Z247216RR	24 x 72 x 29.5-30	65	135.45	6	\$637	\$774	N/A	\$287
Z246616RR	24 x 66 x 29.5-30	70	127.05	5.75	\$609	\$735	N/A	\$287
Z246016RR	24 x 60 x 29.5-30	70	117.60	5.25	\$571	\$688	N/A	\$238
Z245416RR	24 x 54 x 29.5-30	70	108.15	5.25	\$539	\$646	N/A	\$238
Z244816RR	24 x 48 x 29.5-30	65	99.75	4.25	\$494	\$590	N/A	\$192
Z244216RR	24 x 42 x 29.5-30	70	88.20	4	\$443	\$529	N/A	\$192
Z243616RR	24 x 36 x 29.5-30	70	77.70	3.50	\$401	\$478	N/A	\$145
Z207216RR	20 x 72 x 29.5-30	70	122.85	6	\$583	\$698	N/A	\$287
Z206616RR	20 x 66 x 29.5-30	70	114.45	5.75	\$556	\$661	N/A	\$287
Z206016RR	20 x 60 x 29.5-30	70	106.05	5.25	\$522	\$619	N/A	\$238
Z205416RR	20 x 54 x 29.5-30	70	97.65	5.25	\$491	\$579	N/A	\$238
Z204816RR	20 x 48 x 29.5-30	70	90.30	4.25	\$452	\$532	N/A	\$192
Z204216RR	20 x 42 x 29.5-30	70	79.80	4	\$405	\$478	N/A	\$192
Z203616RR	20 x 36 x 29.5-30	70	70.35	3.50	\$365	\$427	N/A	\$145

16" Throat. Return has **no pedestal**. Grommet in worksurface. Shipped RTA (ready to assemble). For use with extended corners, desks and islands with 16"throat. Accepts same depth storage shells under worksurface, see pages **xxxx**.

Required Specifications

- Top finish
- Top/edge detail
- Base finish
- Lock finish

Optional Specifications

- HP laminate
- Handles*
- Key #
- Modesty Type
- Grommet position or power block cut-out

Accessories

- Power block
- Keyboard
- Pencil drawer

RETURNS

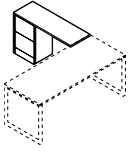

Full to Floor Return, No Modesty - LEFT

MODEL#	DIMENSIONS D x W x H	FREIGHT CLASS	WT/LBS.	CUBIC FT.	1" TOP	1.5" TOP	GLAZE ADD	HP ADD
Z2448NRL	24 x 48 x 29.5-30	150	127	24.25	\$879	\$957	N/A	\$195
Z2442NRL	24 x 42 x 29.5-30	150	123	21.25	\$871	\$939	N/A	\$171
Z2048NRL	20 x 48 x 29.5-30	150	114	20.50	\$828	\$894	N/A	\$163
Z2042NRL	20 x 42 x 29.5-30	125	111	18	\$808	\$866	N/A	\$142

Return has no modesty. File/file pedestal on **left**. Pedestal locks. Full to the floor pedestal configurations can be switched for a **15% upcharge**.

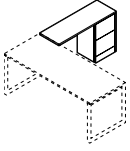

Full to Floor Return, No Modesty - RIGHT

Z2448NRR	24 x 48 x 29.5-30	150	127	24.25	\$879	\$957	N/A	\$195
Z2442NRR	24 x 42 x 29.5-30	150	123	21.25	\$871	\$940	N/A	\$171
Z2048NRR	20 x 48 x 29.5-30	150	114	20.50	\$828	\$894	N/A	\$163
Z2042NRR	20 x 42 x 29.5-30	125	111	18	\$808	\$866	N/A	\$142

Return has no modesty. File/file pedestal on **right**. Pedestal locks. Full to the floor pedestal configurations can be switched for a **15% upcharge**.

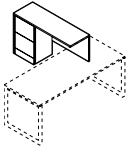

Full to Floor Return - LEFT

Z2448SRL	24 x 48 x 29.5-30	150	135	24.25	\$956	\$1034	N/A	\$195
Z2442SRL	24 x 42 x 29.5-30	125	130	21.25	\$940	\$1008	N/A	\$171
Z2048SRL	20 x 48 x 29.5-30	125	123	20.50	\$905	\$971	N/A	\$163
Z2042SRL	20 x 42 x 29.5-30	125	119	18	\$878	\$936	N/A	\$142

File/file pedestal on **left**. 12"H modesty panel. Pedestal locks. Full to the floor pedestal configurations can be switched for a **15% upcharge**.

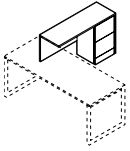

Full to Floor Return - RIGHT

Z2448SRR	24 x 48 x 29.5-30	150	135	24.25	\$956	\$1034	N/A	\$195
Z2442SRR	24 x 42 x 29.5-30	125	130	21.25	\$940	\$1008	N/A	\$171
Z2048SRR	20 x 48 x 29.5-30	125	123	20.50	\$905	\$971	N/A	\$163
Z2042SRR	20 x 42 x 29.5-30	125	119	18	\$878	\$936	N/A	\$142

File/file pedestal on **right**. 12"H modesty panel. Pedestal locks. Full to the floor pedestal configurations can be switched for a **15% upcharge**.

Required Specifications

Top finish
Top/edge detail
Base finish
Handles

Optional Specifications

HP laminate
Key #
Grommet position or power block cut-out

Accessories

Power block
Keyboard
Pencil drawer

RETURNS

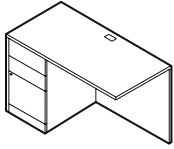

Full to Floor Flush Return - LEFT

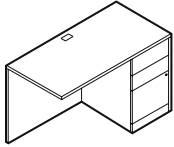

Full to Floor Flush Return - RIGHT

MODEL#	DIMENSIONS	FREIGHT CLASS	WT/LBS.	CUBIC FT.	1" TOP	1.5" TOP	GLAZE ADD	HP ADD
D x W x H								
Z24723L	24 x 72 x 29.5-30	125	171	24.50	\$1268	\$1382	N/A	\$287
Z24663L	24 x 66 x 29.5-30	125	171	24.50	\$1245	\$1348	N/A	\$287
Z24603L	24 x 60 x 29.5-30	125	171	24.50	\$1164	\$1263	N/A	\$264
Z24543L	24 x 54 x 29.5-30	125	171	24.50	\$1125	\$1215	N/A	\$264
Z24483L	24 x 48 x 29.5-30	125	171	24.50	\$1061	\$1141	N/A	\$210
Z20723L	20 x 72 x 29.5-30	65	97	4.30	\$1160	\$1258	N/A	\$287
Z20663L	20 x 66 x 29.5-30	65	97	4.30	\$1121	\$1215	N/A	\$287
Z20603L	20 x 60 x 29.5-30	65	97	4.30	\$1102	\$1187	N/A	\$238
Z20543L	20 x 54 x 29.5-30	65	97	4.30	\$1056	\$1136	N/A	\$238
Z20483L	20 x 48 x 29.5-30	125	154	20.75	\$1033	\$1103	N/A	\$176

Standard with box/box/file pedestal on **left**. Grommet in worksurface. One pencil tray. File drawer and lower box drawer lock. Full to the floor pedestal configurations can be switched for a **15% upcharge**.

Z24723R	24 x 72 x 29.5-30	125	171	24.50	\$1268	\$1382	N/A	\$287
Z24663R	24 x 66 x 29.5-30	125	171	24.50	\$1245	\$1348	N/A	\$287
Z24603R	24 x 60 x 29.5-30	125	171	24.50	\$1164	\$1263	N/A	\$264
Z24543R	24 x 54 x 29.5-30	125	171	24.50	\$1125	\$1215	N/A	\$264
Z24483R	24 x 48 x 29.5-30	125	171	24.50	\$1061	\$1141	N/A	\$210
Z20723R	20 x 72 x 29.5-30	65	97	4.30	\$1160	\$1258	N/A	\$287
Z20663R	20 x 66 x 29.5-30	65	97	4.30	\$1121	\$1215	N/A	\$287
Z20603R	20 x 60 x 29.5-30	65	97	4.30	\$1102	\$1187	N/A	\$238
Z20543R	20 x 54 x 29.5-30	65	97	4.30	\$1056	\$1136	N/A	\$238
Z20483R	20 x 48 x 29.5-30	125	154	20.75	\$1033	\$1103	N/A	\$176

Standard with box/box/file pedestal on **right**. Grommet in worksurface. One pencil tray. File drawer and lower box drawer lock. Full to the floor pedestal configurations can be switched for a **15% upcharge**.

Required Specifications

Top finish
Top/edge detail
Base finish
Lock finish

Optional Specifications

HP laminate Handles
Key #
Modesty type
Grommet position or power block cut-out

Accessories

Power block
Pencil drawer

BRIDGES

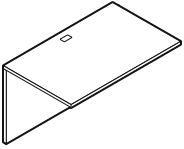

Flush Bridge*

MODEL#	DIMENSIONS D x W x H	FREIGHT CLASS	WT/LBS.	CUBIC FT.	1" TOP	1.5" TOP	GLAZE ADD	HP ADD
Z2448FB	24 x 48 x 29.5-30	70	91	4.30	\$471	\$546	N/A	\$192
Z2442FB	24 x 42 x 29.5-30	70	79	3.80	\$436	\$502	N/A	\$192
Z2436FB	24 x 36 x 29.5-30	70	69	3.30	\$436	\$502	N/A	\$145
Z2048FB	20 x 48 x 29.5-30	70	83	4.30	\$456	\$522	N/A	\$192
Z2042FB	20 x 42 x 29.5-30	70	72	3.80	\$423	\$489	N/A	\$192
Z2036FB	20 x 36 x 29.5-30	70	63	3.30	\$423	\$489	N/A	\$145

Top surface, back panel and hardware to create a "U" shape by connecting two units with full end panels. Grommet in worksurface. Shipped RTA (ready to assemble).

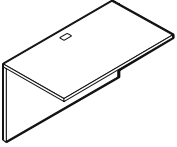

Flush Bridge

Z1648B	15.8 x 48 x 29.5-30	70	66.15	4.25	\$357	\$422	N/A	\$145
Z1642B	15.8 x 42 x 29.5-30	70	59.85	3.75	\$312	\$371	N/A	\$145

16" Throat. Top surface, back panel and hardware to create a "U" shape by connecting two units with a 16" throat and full end panels. Grommet in worksurface. Shipped RTA (ready to assemble).

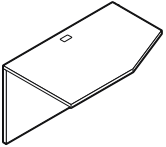

Space Saver Bridge - LEFT

Z244816BL	24 x 48 x 29.5-30	70	82	4.25	\$417	\$513	N/A	\$192
Z244216BL	24 x 42 x 29.5-30	70	71	3.75	\$366	\$452	N/A	\$192
Z214816BL	21 x 48 x 29.5-30	70	76	4.25	\$387	\$467	N/A	\$192
Z214216BL	21 x 42 x 29.5-30	70	65	3.75	\$334	\$407	N/A	\$192

16" Throat. Top surface, back panel and hardware to connect extended corners, desks and islands with a 16" throat. Grommet in worksurface. Shipped RTA (ready to assemble).

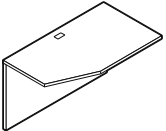

Space Saver Bridge - RIGHT

Z244816BR	24 x 48 x 29.5-30	70	82	4.25	\$417	\$513	N/A	\$192
Z244216BR	24 x 42 x 29.5-30	70	71	3.75	\$366	\$452	N/A	\$192
Z214816BR	21 x 48 x 29.5-30	70	76	4.25	\$387	\$467	N/A	\$192
Z214216BR	21 x 42 x 29.5-30	70	65	3.75	\$334	\$407	N/A	\$192

16" Throat. Top surface, back panel and hardware to connect extended corners, desks and islands with a 16" throat. Grommet in worksurface. Shipped RTA (ready to assemble).

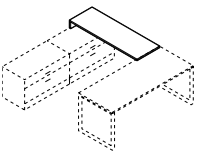

Overlapping Bridge - LEFT*

Z2468TRL	24 x 68 x 5.9	85	64	5.25	\$443	\$557	N/A	\$276
Z2462TRL	24 x 62 x 5.9	85	59	4.70	\$413	\$517	N/A	\$252
Z2472TRL	24 x 72 x 5.9	85	64	5.25	\$450	\$564	N/A	\$292
Z2466TRL	24 x 66 x 5.9	85	62	4.70	\$423	\$528	N/A	\$268

For 20"/24"D, 23.75"/24.25"H Storage with No Modesty. Overlaps storage on **left**.

- Use Z2462TRR and Z2468TRR for 20"D storage.
- Use Z2466TRR and Z2472TRR for 24"D storage.

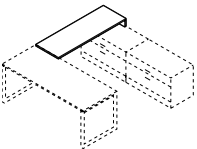

Overlapping Bridge - RIGHT*

Z2468TRR	24 x 68 x 5.9	85	64	5.25	\$443	\$557	N/A	\$276
Z2462TRR	24 x 62 x 5.9	85	59	4.70	\$413	\$517	N/A	\$252
Z2472TRR	24 x 72 x 5.9	85	64	5.25	\$450	\$564	N/A	\$292
Z2466TRR	24 x 66 x 5.9	85	62	4.70	\$423	\$528	N/A	\$268

For 20"/24"D, 23.75"/24.25"H Storage with No Modesty. Overlaps storage on **right**.

- Use Z2462TRR and Z2468TRR for 20"D storage.
- Use Z2466TRR and Z2472TRR for 24"D storage.

Required Specifications

Top finish
Top/edge detail
Base finish

Optional Specifications

HP laminate
Grommet position or power block cut-out

Accessories

Power block
Pencil drawer*

TRANSITIONAL BRIDGES

MODEL# DIMENSIONS FREIGHT CLASS WT/LBS. CUBIC FT. 1" TOP 1.5" TOP GLAZE ADD HP ADD

D x W x H

Z24483BR	24 x 48 x 13-13.5	70	55	3.50	\$471	\$546	N/A	\$192
Z24423BR	24 x 42 x 13-13.5	70	48	3.10	\$436	\$528	N/A	\$171
Z24363BR	24 x 36 x 13-13.5	70	43	2.70	\$436	\$516	N/A	\$146
Z20483BR	20 x 48 x 13-13.5	70	48	3	\$456	\$544	N/A	\$163
Z20423BR	20 x 42 x 13-13.5	70	43	2.70	\$423	\$501	N/A	\$142
Z20363BR	20 x 36 x 13-13.5	70	38	2.40	\$423	\$491	N/A	\$122

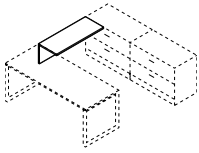

Flush Bridge

For use with storage models ZxxxxBBOL/R and ZxxxxBLFL/R. 12"H modesty panel..

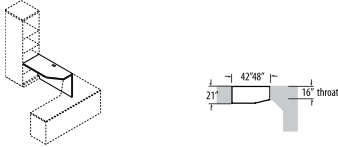

Transitional Bridge - LEFT

Z2148TRBL	21 x 48 x 29.5-30	70	75.83	4.25	\$402	\$482	N/A	\$192
Z2142TRBL	21 x 42 x 29.5-30	70	64.78	3.75	\$351	\$424	N/A	\$192

For 21" Wide Storage Module. Top surface, back panel, shorter kickplate and hardware to connect 21" wide storage module with 16" throat. Grommet in worksurface. Shipped RTA (ready to assemble).

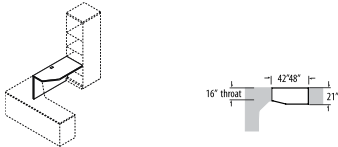

Transitional Bridge - RIGHT

Z2148TRBR	21 x 48 x 29.5-30	70	75.83	4.25	\$402	\$482	N/A	\$192
Z2142TRBR	21 x 42 x 29.5-30	70	64.78	3.75	\$351	\$424	N/A	\$192

For 21" Wide Storage Module. Top surface, back panel, shorter kickplate and hardware to connect 21" wide storage module with 16" throat. Grommet in worksurface. Shipped RTA (ready to assemble).

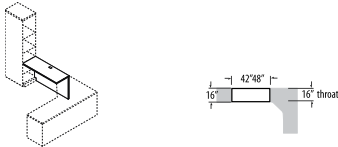

Transitional Bridge - LEFT

Z1648TRBL	16 x 48 x 29.5-30	70	68.58	4.25	\$372	\$437	N/A	\$145
Z1642TRBL	16 x 42 x 29.5-30	70	58.96	3.75	\$328	\$388	N/A	\$145

For 16" Wide Storage Module. Top surface, back panel and hardware to connect 16" wide storage module with 16" throat. Grommet in worksurface. Shipped RTA (ready to assemble).

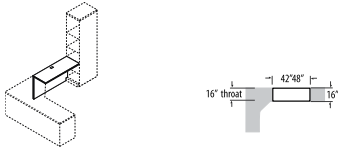

Transitional Bridge - RIGHT

Z1648TRBR	16 x 48 x 29.5-30	70	68.58	4.25	\$372	\$437	N/A	\$145
Z1642TRBR	16 x 42 x 29.5-30	70	58.96	3.75	\$328	\$388	N/A	\$145

For 16" Wide Storage Module. Top surface, back panel and hardware to connect 16" wide storage module with 16" throat. Grommet in worksurface. Shipped RTA (ready to assemble).

Required Specifications

Top finish
Top/edge detail
Base finish

Optional Specifications

HP laminate
Grommet position or power block cut-out

Accessories

Power block
Pencil drawer*

18"H CREDENZAS

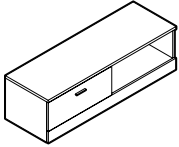

Lateral File Credenza - LEFT

MODEL#	DIMENSIONS D x W x H	FREIGHT CLASS	WT/LBS.	CUBIC FT.	1"TOP	1.5" TOP	GLAZE ADD	HP ADD
Z2472LOFL	24 x 72 x 17.87-18.37	125	181	22.75	\$1222	\$1321	N/A	\$292
Z2460LOFL	24 x 60 x 17.87-18.37	100	160	19.25	\$1086	\$1168	N/A	\$244
Z2072LOFL	20 x 72 x 17.87-18.37	100	164	19.25	\$1138	\$1220	N/A	\$244
Z2060LOFL	20 x 60 x 17.87-18.37	100	143	16.25	\$1004	\$1072	N/A	\$203

1 high lateral file on the **left**, open storage on the **right**.

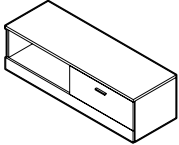

Lateral File Credenza - RIGHT

Z2472LOFR	24 x 72 x 17.87-18.37	125	181	22.75	\$1222	\$1321	N/A	\$292
Z2460LOFR	24 x 60 x 17.87-18.37	100	160	19.25	\$1086	\$1168	N/A	\$244
Z2072LOFR	20 x 72 x 17.87-18.37	100	164	19.25	\$1138	\$1220	N/A	\$244
Z2060LOFR	20 x 60 x 17.87-18.37	100	143	16.25	\$1004	\$1072	N/A	\$203

1 high lateral file on the **right**, open storage on the **left**.

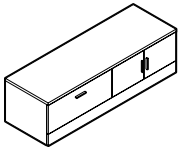

Lateral File Credenza - LEFT*

Z2472LSFL	24 x 72 x 17.87-18.37	100	197	22.75	\$1424	\$1523	\$302	\$292
Z2460LSFL	24 x 60 x 17.87-18.37	100	174	19.25	\$1284	\$1366	\$269	\$244
Z2072LSFL	20 x 72 x 17.87-18.37	100	178	19.25	\$1334	\$1416	\$302	\$244
Z2060LSFL	20 x 60 x 17.87-18.37	100	155	16.25	\$1197	\$1265	\$269	\$203

1 high lateral file on the **left**, closed storage on the **right**.

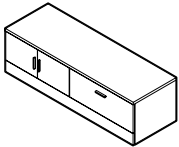

Lateral File Credenza - RIGHT*

Z2472LSFR	24 x 72 x 17.87-18.37	100	197	22.75	\$1424	\$1523	\$302	\$292
Z2460LSFR	24 x 60 x 17.87-18.37	100	174	19.25	\$1284	\$1366	\$269	\$244
Z2072LSFR	20 x 72 x 17.87-18.37	100	178	19.25	\$1334	\$1416	\$302	\$244
Z2060LSFR	20 x 60 x 17.87-18.37	100	155	16.25	\$1197	\$1265	\$269	\$203

1 high lateral file on the **right**, closed storage on the **left**.

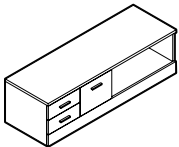

Mixed Storage Credenza - LEFT

Z2472LMOL	24 x 72 x 17.87-18.37	100	197	22.75	\$1408	\$1507	N/A	\$292
Z2460LMOL	24 x 60 x 17.87-18.37	100	176	19.25	\$1285	\$1367	N/A	\$244
Z2072LMOL	20 x 72 x 17.87-18.37	100	178	19.25	\$1319	\$1401	N/A	\$244
Z2060LMOL	20 x 60 x 17.87-18.37	100	157	16.25	\$1199	\$1268	N/A	\$203

1 high mixed drawers on the **left**, open storage on the **right**.

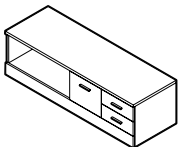

Mixed Storage Credenza - RIGHT

Z2472LMOR	24 x 72 x 17.87-18.37	100	197	22.75	\$1408	\$1507	N/A	\$292
Z2460LMOR	24 x 60 x 17.87-18.37	100	176	19.25	\$1285	\$1367	N/A	\$244
Z2072LMOR	20 x 72 x 17.87-18.37	100	178	19.25	\$1319	\$1401	N/A	\$244
Z2060LMOR	20 x 60 x 17.87-18.37	100	157	16.25	\$1199	\$1268	N/A	\$203

1 high mixed drawers on the **right**, open storage on the **left**.

Required Specifications

Top finish
Top/edge detail
Base finish
Handles

Optional Specifications

HP laminate
Key #
Glazed doors*
Box drawer - no upcharge

24"H CREDENZAS

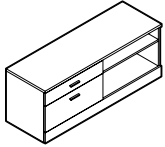

Lateral File Credenza - LEFT

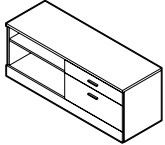

Lateral File Credenza - RIGHT

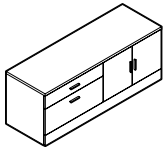

Lateral File Credenza - LEFT

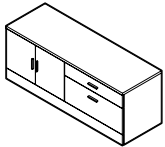

Lateral File Credenza - RIGHT

MODEL#	DIMENSIONS D x W x H	FREIGHT CLASS	WT/LBS.	CUBIC FT.	1" TOP	1.5" TOP	GLAZE ADD	HP ADD
Z2472HBFL	24 x 72 x 23.75-24.25	125	229	29.25	\$1532	\$1631	N/A	\$292
Z2460HBFL	24 x 60 x 23.75-24.25	100	201	24.50	\$1357	\$1439	N/A	\$244
Z2072HBFL	20 x 72 x 23.75-24.25	100	207	24.75	\$1442	\$1524	N/A	\$244
Z2060HBFL	20 x 60 x 23.75-24.25	100	180	20.75	\$1271	\$1340	N/A	\$203

1.5 high box/lateral file on the **left**, open storage on the **right**.

Z2472HBFR	24 x 72 x 23.75-24.25	125	229	29.25	\$1532	\$1631	N/A	\$292
Z2460HBFR	24 x 60 x 23.75-24.25	100	201	24.50	\$1357	\$1439	N/A	\$244
Z2072HBFR	20 x 72 x 23.75-24.25	100	207	24.75	\$1442	\$1524	N/A	\$244
Z2060HBFR	20 x 60 x 23.75-24.25	100	180	20.75	\$1271	\$1340	N/A	\$203

1.5 high box/lateral file on the **right**, open storage on the **left**.

Z2472HFSL	24 x 72 x 23.75-24.25	100	251	29.25	\$1793	\$1892	\$416	\$292
Z2460HFSL	24 x 60 x 23.75-24.25	100	221	24.50	\$1599	\$1681	\$359	\$244
Z2072HFSL	20 x 72 x 23.75-24.25	100	227	24.75	\$1684	\$1766	\$416	\$244
Z2060HFSL	20 x 60 x 23.75-24.25	100	198	20.75	\$1505	\$1574	\$359	\$203

1.5 high box/lateral file on the **left**, closed storage on the **right**.

Z2472HFSL	24 x 72 x 23.75-24.25	100	251	29.25	\$1793	\$1892	\$416	\$292
Z2460HFSL	24 x 60 x 23.75-24.25	100	221	24.50	\$1599	\$1681	\$359	\$244
Z2072HFSL	20 x 72 x 23.75-24.25	100	227	24.75	\$1684	\$1766	\$416	\$244
Z2060HFSL	20 x 60 x 23.75-24.25	100	198	20.75	\$1505	\$1574	\$359	\$203

1.5 high box/lateral file on the **right**, closed storage on the **left**.

Required Specifications

Top finish
Top/edge detail
Base finish
Handles

Optional Specifications

HP laminate
Key #
Glazed doors*
Box drawer - no upcharge

CREDENZAS

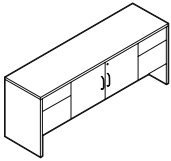

Glazed door option

Center Storage Credenza**

MODEL#	DIMENSIONS D x W x H	FREIGHT CLASS	WT/LBS.	CUBIC FT.	1" TOP	1.5" TOP	GLAZE ADD	HP ADD
Z2072C	20 x 72 x 29.5-30	100	286	30	\$1548	\$1927	\$508	\$287

Standard with box/file pedestals on both sides and self-closing hinged center doors covering one adjustable shelf. Pedestals and doors lock, keyed alike. One pencil tray.

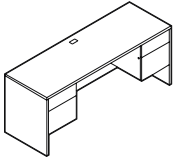

Kneespace Credenza*

Z2472CK	24 x 72 x 29.5-30	125	262	35.50	\$1256	\$1468	N/A	\$287
Z2466CK	24 x 66 x 29.5-30	125	250	33	\$1256	\$1421	N/A	\$287
Z2072CK	20 x 72 x 29.5-30	125	235	30	\$1200	\$1321	N/A	\$287
Z2066CK	20 x 66 x 29.5-30	100	225	27.75	\$1200	\$1294	N/A	\$287
Z2060CK	20 x 60 x 29.5-30	100	219	25.25	\$1154	\$1229	N/A	\$238

Standard with box/file pedestals on both sides. Center is open. Pedestals lock, keyed alike. One pencil tray. Grommet in worksurface.

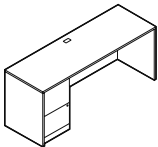

Full to Floor Single Pedestal Credenza- LEFT*

Z2472CS2L	24 x 72 x 29.5-30	100	228	25.75	\$1181	\$1300	N/A	\$287
Z2466CS2L	24 x 66 x 29.5-30	125	217	32.75	\$1159	\$1269	N/A	\$287
Z2072CS2L	20 x 72 x 29-29.5	125	203	30.25	\$1082	\$1181	N/A	\$287
Z2066CS2L	20 x 66 x 29-29.5	125	193	27.75	\$1042	\$1131	N/A	\$287

Standard with full to floor file/file pedestal on the **left**. Pedestal locks. One pencil tray. Grommet in worksurface.

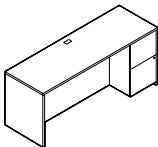

Full to Floor Single Pedestal Credenza- RIGHT*

Z2472CS2R	24 x 72 x 29.5-30	100	228	25.75	\$1181	\$1300	N/A	\$287
Z2466CS2R	24 x 66 x 29.5-30	125	217	32.75	\$1159	\$1269	N/A	\$287
Z2072CS2R	20 x 72 x 29.5-30	125	203	30.25	\$1082	\$1181	N/A	\$287
Z2066CS2R	20 x 66 x 29.5-30	125	193	27.75	\$1042	\$1131	N/A	\$287

Standard with full to floor file/file pedestal on the **right**. Pedestal locks. One pencil tray. Grommet in worksurface.

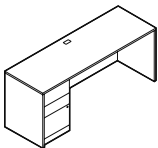

Full to Floor Single Pedestal Credenza- LEFT*

Z2472CS4L	24 x 72 x 29-29.5	125	228	35.75	\$1229	\$1348	N/A	\$287
Z2466CS4L	24 x 66 x 29-29.5	125	217	32.75	\$1209	\$1319	N/A	\$287
Z2072CS4L	20 x 72 x 29-29.5	125	203	30.25	\$1121	\$1217	N/A	\$287
Z2066CS4L	20 x 66 x 29-29.5	125	193	25.75	\$1082	\$1176	N/A	\$287

Standard with full to floor box/box/file pedestal on the **left**. File drawer and lower box drawer lock. One pencil tray. Grommet in worksurface.

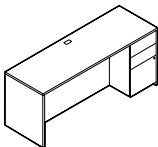

Full to Floor Single Pedestal Credenza- RIGHT*

Z2472CS4R	24 x 72 x 29-29.5	125	228	35.75	\$1229	\$1348	N/A	\$287
Z2466CS4R	24 x 66 x 29-29.5	125	217	32.75	\$1209	\$1319	N/A	\$287
Z2072CS4R	20 x 72 x 29-29.5	125	203	30.25	\$1121	\$1219	N/A	\$287
Z2066CS4R	20 x 66 x 29-29.5	125	193	25.75	\$1082	\$1176	N/A	\$287

Standard with full to floor box/box/file pedestal on the **right**. File drawer and lower box drawer lock. One pencil tray. Grommet in worksurface.

Required Specifications

Top finish
Top/edge detail
Base finish
Lock finish*

Optional Specifications

HP laminate
Key #*
Modesty type (only Z2xxxCK)
Grommet position or power block cut-out

Accessories

Keyboard**
Power block (not Z2072C)
Pencil drawer (Z2472S2L/R only)

CRENZAS

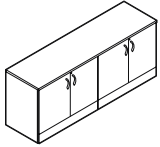

Glazed door option

Storage Cabinet Credenza**

MODEL#	DIMENSIONS D x W x H	FREIGHT CLASS	WT/LBS.	CUBIC FT.	1" TOP	1.5" TOP	GLAZE ADD	HP ADD
Z2472SCSC	24 x 72 x 29.5-30	100	345	35.75	\$1695	\$1810	\$1139	\$287
Z2072SCSC	20 x 72 x 29.5-30	92.5	315	30.25	\$1490	\$1614	\$1139	\$287

Two storage cabinets side-by-side. Hinged doors cover one adjustable shelf. Locking doors keyed alike.

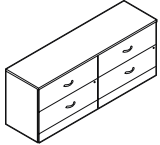

Storage Cabinet Credenza**

Z2472LF2	24 x 72 x 29.5-30	100	345	35.75	\$1955	\$2228	N/A	\$287
Z2072LF2	20 x 72 x 29.5-30	92.5	315	30.25	\$1915	\$2227	N/A	\$287

Two 2-drawer lateral files side-by-side. Locking drawers, keyed alike. File bars included for side-to-side and front-to-back letter and legal filing capability. Anti-lock tilt suspension

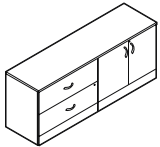

Glazed door option

Lateral File/Storage Cabinet Credenza**

Z2472LS	24 x 72 x 29.5-30	100	321	35.75	\$1749	\$2013	\$570	\$287
Z2072LS	20 x 72 x 29.5-30	100	286	30.25	\$1709	\$2012	\$570	\$287

One 2-drawer lateral file and one storage cabinet. Locking door/drawers, keyed alike. Storage cabinet includes one adjustable shelf. File bars included for side-to-side and front-to-back letter and legal filing capability. Anti-lock tilt suspension.

- File drawer construction is for accommodating hanging files NOT for stacking materials on the drawer bottom.

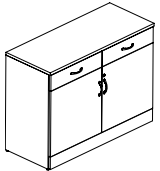

Glazed door option

Buffet Credenza**

Z482036BD	20 x 48 x 36	125	163	22.50	\$1661	\$1756	\$716	\$311
-----------	--------------	-----	-----	-------	--------	--------	-------	-------

Buffet credenza with one locking storage compartment with two doors. Hinged doors cover one three-position height adjustable shelf. Two 6" drawers above storage compartment are non-locking.

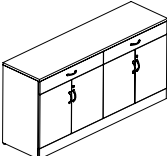
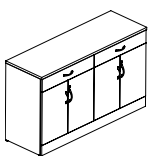

Glazed door option

Buffet Credenza*

Z722036BD	20 x 72 x 36	125	242	33.50	\$2409	\$2525	\$1431	\$502
Z602036BD	20 x 60 x 36	125	188	28	\$2089	\$2195	\$1313	\$406

Buffet credenza with two locking storage compartments side by side. Hinged doors cover 1 three-position height adjustable shelf. Two 6" drawers above storage compartment are non-locking.

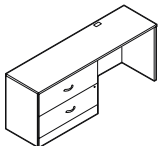

Kneespace Lateral File Credenza - LEFT

Z2472LKL	24 x 72 x 29.5-30	125	262	35.75	\$1537	\$1772	N/A	\$287
Z2072LKL	20 x 72 x 29.5-30	125	235	30.25	\$1498	\$1772	N/A	\$287

One 2-drawer lateral file on the left. Locking drawers. File bars included for side-to-side and front-to-back letter/legal filing capability. Anti-lock tilt suspension. Grommet in worksurface.

- File drawer construction is for accommodating hanging files NOT for stacking materials on the drawer bottom.

Required Specifications

Top finish
Top/edge detail
Base finish
Lock finish*

Optional Specifications

HP laminate
Key #*
Modesty type (only Z2xxxxCK)
Grommet position or power block cut-out

Handles*

Glazed door**

Accessories

Keyboard**
Power block (not Z2072C)
Pencil drawer (Z2472S2L/R only)

CREDENZAS

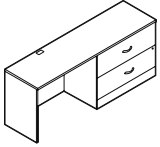

Kneespace Lateral File Credenza - RIGHT

MODEL#	DIMENSIONS D x W x H	FREIGHT CLASS	WT/LBS.	CUBIC FT.	1" TOP	1.5" TOP	GLAZE ADD	HP ADD
Z2472LKR	24 x 72 x 29.5-30	125	262	35.75	\$1537	\$1772	N/A	\$287
Z2072LKR	20 x 72 x 29.5-30	125	235	30.25	\$1498	\$1772	N/A	\$287

One 2-drawer lateral file on the **right**. Locking drawers. File bars included for side-to-side and front-to-back letter/legal filing capability. Anti-lock tilt suspension. Grommet in worksurface.

- File drawer construction is for accommodating hanging files *NOT* for stacking materials on the drawer bottom.

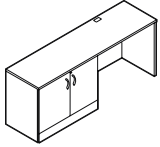

Kneespace Storage Cabinet Credenza- LEFT**



Glazed door option

Z2472SKL	24 x 72 x 29.5-30	125	241	35.75	\$1212	\$1456	\$570	\$287
Z2072SKL	20 x 72 x 29.5-30	125	207	30.25	\$1172	\$1455	\$570	\$287

One storage cabinet on the **left**. Locking doors. Storage cabinet has one adjustable shelf. Grommet in worksurface.

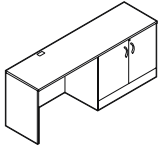

Kneespace Storage Cabinet Credenza- RIGHT**



Glazed door option

Z2472SKR	24 x 72 x 29.5-30	125	241	35.75	\$1212	\$1456	\$570	\$287
Z2072SKR	20 x 72 x 29.5-30	125	207	30.25	\$1172	\$1455	\$570	\$287

One storage cabinet on the **right**. Locking doors. Storage cabinet has one adjustable shelf. Grommet in worksurface.

Required Specifications

Top finish Base finish
Top/edge detail
Handles*
Lock finish*

Optional Specifications

HP laminate Handles
Key # Glazed door*
Grommet position or power block cut-out

Accessories

Power block

5-SIDED CORNERS

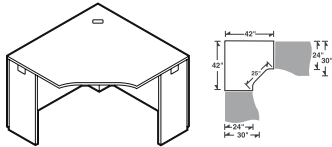

5-Sided Corner, 24" Throat

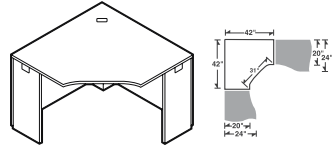

5-Sided Corner, 20" Throat

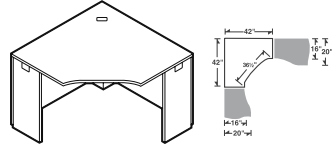

5-Sided Corner, 16" Throat

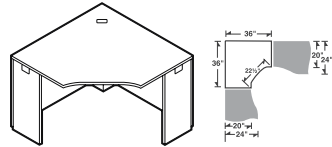

5-Sided Corner, 20" Throat

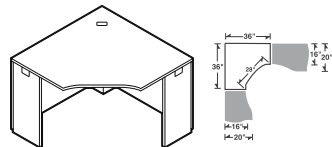

5-Sided Corner, 16" Throat

MODEL#	DIMENSIONS D x W x H	FREIGHT CLASS	WT/LBS.	CUBIC FT.	1" TOP	1.5" TOP	GLAZE ADD	HP ADD
Z42245C	42 x 42 x 29.5-30	65	133	5.75	\$734	\$890	N/A	\$385

Connects to **30" D** space saver connectable surfaces, **24" D** connectables, returns and bridge. Grommet in worksurface. Narrow end panels on left and right. Shipped RTA (ready to assemble). *Not freestanding.*

- Modesty Panel is 1" off of ground.
- Full End Panel(s) are available - add **15% upcharge**

Z42205C	42 x 42 x 29.5-30	70	129	5.75	\$734	\$890	N/A	\$385
---------	-------------------	----	-----	------	-------	-------	-----	-------

Connects to **24" D** space saver connectable surfaces, **20" D** returns, lateral files, storage/lateral file credenzas, credenzas, and bridges. Grommet in worksurface. Narrow end panels on left and right. Shipped RTA (ready to assemble). *Not freestanding.*

- Modesty Panel is 1" off of ground.
- Full End Panel(s) are available - add **15% upcharge**

Z42165C	42 x 42 x 29.5-30	70	124	5.75	\$757	\$870	N/A	\$382
---------	-------------------	----	-----	------	-------	-------	-----	-------

Connects to **20" D** space saver connectable surfaces, **16" D** returns, lateral files, storage/lateral file credenzas, credenzas, and bridges. Grommet in worksurface. Narrow end panels on left and right. Shipped RTA (ready to assemble). *Not freestanding.*

- Modesty Panel is 1" off of ground.
- Full End Panel(s) are available - add **15% upcharge**

Z36205C	36 x 36 x 29.5-30	65	109	4.80	\$620	\$709	N/A	\$248
---------	-------------------	----	-----	------	-------	-------	-----	-------

Connects to **24" D** space saver connectable surfaces, **20" D** returns, lateral files, storage/lateral file credenzas, credenzas, and bridges. Grommet in worksurface. Narrow end panels on left and right. Shipped RTA (ready to assemble). *Not freestanding.*

- Modesty Panel is 1" off of ground.
- Full End Panel(s) are available - add **15% upcharge**

Z36165C	36 x 36 x 29.5-30	70	105	4.80	\$661	\$748	N/A	\$216
---------	-------------------	----	-----	------	-------	-------	-----	-------

Connects to **20" D** space saver connectable surfaces, **16" D** returns, lateral files, storage/lateral file credenzas, credenzas, and bridges. Grommet in worksurface. Narrow end panels on left and right. Shipped RTA (ready to assemble). *Not freestanding.*

- Modesty Panel is 1" off of ground.
- Full End Panel(s) are available - add **15% upcharge**

Required Specifications

Top finish
Top/edge detail
Base finish

Optional Specifications

HP laminate
Grommet position or power block cut-out

Accessories

Power block
Keyboard (*Not available on Z36165C*)

LEFT EXTENDED CORNER DESKS

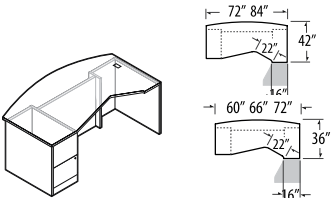

Single Pedestal Bow Top
Extended Corner Desk - LEFT*

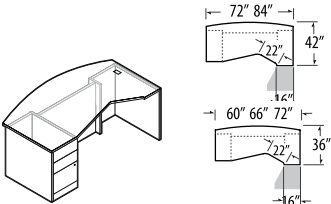

Single Pedestal Bow Top
Extended Corner Desk - LEFT*

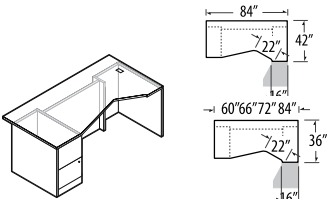

Single Pedestal Extended
Corner Desk - LEFT*

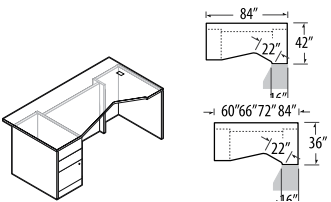

Single Pedestal Extended
Corner Desk - LEFT

MODEL#	DIMENSIONS	FREIGHT CLASS	WT/LBS.	CUBIC FT.	1" TOP	1.5" TOP	GLAZE ADD	HP ADD
D x W x H								
Z4284EB2L	42 x 84 x 29.5-30	70	316.05	20.50	\$1568	\$1785	\$689	\$762
Z4272EB2L	42 x 72 x 29.5-30	150	331	59	\$1548	\$1734	\$570	\$572
Z3672EB2L	36 x 72 x 29.5-30	150	273	50.75	\$1409	\$1572	\$570	\$430
Z3666EB2L	36 x 66 x 29.5-30	150	260.40	46.75	\$1386	\$1536	\$509	\$430
Z3660EB2L	36 x 60 x 29.5-30	125	257.25	42.50	\$1347	\$1483	\$450	\$358

Extended worksurface on right. Standard with **Freestanding** full to floor file/file pedestal on **left** and faux pedestal on **right**. Pedestal locks. Connects to returns or bridges with a 16" throat. Corner has one grommet. Bow top overhangs 2¼" at ends and 6" on center.

- 84" wide desks are shipped RTA (ready to assemble) in 2 cartons.

Z4284EB3L	42 x 84 x 29.5-30	70	315	20.50	\$1583	\$1799	\$689	\$762
Z4272EB3L	42 x 72 x 29.5-30	150	329	59	\$1565	\$1751	\$570	\$572
Z3672EB3L	36 x 72 x 29.5-30	150	270.90	50.75	\$1436	\$1599	\$570	\$430
Z3666EB3L	36 x 66 x 29.5-30	150	259.35	46.75	\$1395	\$1545	\$509	\$430
Z3660EB3L	36 x 60 x 29.5-30	125	255.15	42.50	\$1372	\$1508	\$450	\$358

Extended worksurface on right. Standard with **Freestanding** full to floor box/box/file pedestal on **left** and faux pedestal on **right**. File drawer and lower box drawer lock. Connects to returns or bridges with a 16" throat. Corner has one grommet. Bow top overhangs 2¼" at ends and 6" on center.

- 84" wide desks are shipped RTA (ready to assemble) in 2 cartons.

Z4284E2L	42 x 84 x 29.5-30	70	321.30	20.50	\$1633	\$1839	\$689	\$762
Z3684E2L	36 x 84 x 29.5-30	250	311.85	118	\$1564	\$1770	\$689	\$572
Z3672E2L	36 x 72 x 29.5-30	150	278.25	50.75	\$1403	\$1557	\$570	\$430
Z3666E2L	36 x 66 x 29.5-30	150	265.65	46.75	\$1365	\$1507	\$509	\$430
Z3660E2L	36 x 60 x 29.5-30	125	259.35	42.50	\$1343	\$1471	\$450	\$358

Extended worksurface on right. Standard with **Freestanding** full to floor file/file pedestal on **left** and faux pedestal on **right**. Pedestal locks. Connects to returns or bridges with a 16" throat. Corner has one grommet. Top overhangs 2¼"

- 84" wide desks are shipped RTA (ready to assemble) in 2 cartons.

Z4284E3L	42 x 84 x 29.5-30	70	318.15	20.50	\$1578	\$1784	\$689	\$762
Z3684E3L	36 x 84 x 29.5-30	250	309.75	118	\$1591	\$1796	\$689	\$572
Z3672E3L	36 x 72 x 29.5-30	150	275.10	50.75	\$1432	\$1586	\$570	\$430
Z3666E3L	36 x 66 x 29.5-30	150	263.55	46.75	\$1393	\$1535	\$509	\$430
Z3660E3L	36 x 60 x 29.5-30	125	257.25	42.50	\$1369	\$1496	\$450	\$358

Extended worksurface on right. Standard with **Freestanding** full to floor box/box/file pedestal on **left** and faux pedestal on **right**. File drawer and lower box drawer lock. Connects to returns or bridges with a 16" throat. Corner has one grommet. Top overhangs 2¼"

- 84" wide desks are shipped RTA (ready to assemble) in 2 cartons.

Required Specifications

Top finish
Top/edge detail
Lock finish
Base finish

Optional Specifications

HP laminate Handles
Key # Modesty panel type
Grommet position or power block cut-out

Accessories

Power block
Keyboard
Pencil drawer

RIGHT EXTENDED CORNER DESKS

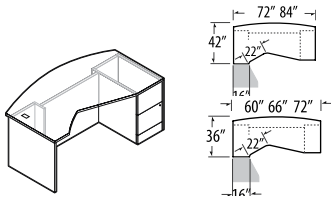

**Single Pedestal Bow Top
Extended Corner Desk - RIGHT**

MODEL#	DIMENSIONS	FREIGHT CLASS	WT/LBS.	CUBIC FT.	1" TOP	1.5" TOP	GLAZE ADD	HP ADD	
D x W x H									
Z4284EB2R	42 x 84 x 29.5-30	70	316.05	20.50	\$1568	\$1785	\$689	\$762	
Z4272EB2R	42 x 72 x 29.5-30	150	331	59	\$1548	\$1734	\$570	\$572	
Z3672EB2R	36 x 72 x 29.5-30	150	273	50.75	\$1409	\$1572	\$570	\$430	
Z3666EB2R	36 x 66 x 29.5-30	150	260.40	46.75	\$1386	\$1536	\$509	\$430	
Z3660EB2R	36 x 60 x 29.5-30	125	257.25	42.50	\$1347	\$1483	\$450	\$358	

Extended worksurface on right. Standard with faux pedestal on **left** and **Freestanding** full to floor file/file pedestal on **right**. Pedestal locks. Connects to returns or bridges with a 16" throat. Corner has one grommet. Bow top overhangs 2¼" at ends and 6" on center.

- 84" wide desks are shipped RTA (ready to assemble) in 2 cartons.

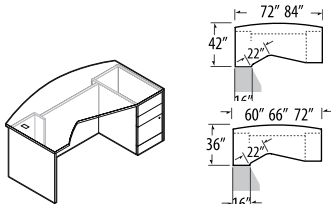

**Single Pedestal Bow Top
Extended Corner Desk - RIGHT**

Z4284EB3R	42 x 84 x 29.5-30	70	315	20.50	\$1583	\$1799	\$689	\$762
Z4272EB3R	42 x 72 x 29.5-30	150	329	59	\$1565	\$1751	\$570	\$572
Z3672EB3R	36 x 72 x 29.5-30	150	270.90	50.75	\$1436	\$1599	\$570	\$430
Z3666EB3R	36 x 66 x 29.5-30	150	259.35	46.75	\$1395	\$1545	\$509	\$430
Z3660EB3R	36 x 60 x 29.5-30	125	255.15	42.50	\$1372	\$1508	\$450	\$358

Extended worksurface on right. Standard with faux pedestal on **left** and **Freestanding** full to floor box/box/file pedestal on **right**. File drawer and lower box drawer lock. Connects to returns or bridges with a 16" throat. Corner has one grommet. Bow top overhangs 2¼" at ends and 6" on center.

- 84" wide desks are shipped RTA (ready to assemble) in 2 cartons.

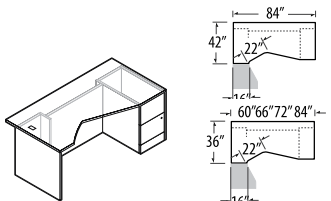

**Single Pedestal Extended
Corner Desk - RIGHT**

Z4284E2R	42 x 84 x 29.5-30	70	321.30	20.50	\$1633	\$1839	\$689	\$762
Z3684E2R	36 x 84 x 29.5-30	250	311.85	118	\$1564	\$1770	\$689	\$572
Z3672E2R	36 x 72 x 29.5-30	150	278.25	50.75	\$1403	\$1557	\$570	\$430
Z3666E2R	36 x 66 x 29.5-30	150	265.65	46.75	\$1365	\$1507	\$509	\$430
Z3660E2R	36 x 60 x 29.5-30	125	259.35	42.50	\$1343	\$1471	\$450	\$358

Extended worksurface on right. Standard with **Freestanding** full to floor file/file pedestal on **right** and faux pedestal on **left**. Pedestal locks. Connects to returns or bridges with a 16" throat. Corner has one grommet. Top overhangs 2¼"

- 84" wide desks are shipped RTA (ready to assemble) in 2 cartons.

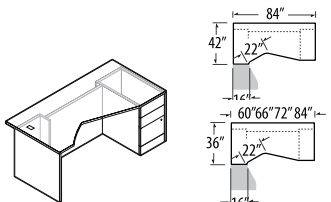

**Single Pedestal Extended
Corner Desk - RIGHT**

Z4284E3R	42 x 84 x 29.5-30	70	318.15	20.50	\$1578	\$1784	\$689	\$762
Z3684E3R	36 x 84 x 29.5-30	250	309.75	118	\$1591	\$1796	\$689	\$572
Z3672E3R	36 x 72 x 29.5-30	150	275.10	50.75	\$1432	\$1586	\$570	\$430
Z3666E3R	36 x 66 x 29.5-30	150	263.55	46.75	\$1393	\$1535	\$509	\$430
Z3660E3R	36 x 60 x 29.5-30	125	257.25	42.50	\$1369	\$1496	\$450	\$358

Extended worksurface on right. Standard with **Freestanding** full to floor box/box/file pedestal on **right** and faux pedestal on **left**. File drawer and lower box drawer lock. Connects to returns or bridges with a 16" throat. Corner has one grommet. Top overhangs 2¼"

- 84" wide desks are shipped RTA (ready to assemble) in 2 cartons.

Required Specifications

Top finish
Top/edge detail
Lock finish
Base finish

Optional Specifications

HP laminate
Key #
Grommet position or power block cut-out
Handles
Modesty panel type

Accessories

Power block
Keyboard
Pencil drawer

LEFT EXTENDED CORNERS (DOES NOT CONNECT)

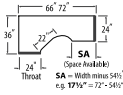
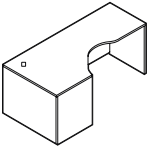

Left Extended Corner, 24" Throat Freestanding

MODEL#	DIMENSIONS D x W x H	FREIGHT CLASS	WT./LBS.	CUBIC FT.	1" TOP	1.5" TOP	GLAZE ADD	HP ADD
Z2472FFL	36 x 72 x 29.5-30	65	184	7	\$937	\$1060	N/A	\$411
Z2466FFL	36 x 66 x 29.5-30	65	175	7	\$937	\$1055	N/A	\$411

Extended worksurface on right. **Full end panels on left and right. Cannot be connected on left or right, due to full end panel.** Corner has one grommet. Shipped RTA (ready to assemble).

- Modesty Panel is 1" off of ground.
- **Z2466FFL** cannot accept pedestals

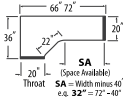
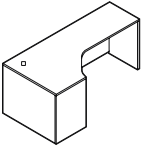

Left Extended Corner, 20" Throat

Z2072FFL	36 x 72 x 29.5-30	65	171	7	\$910	\$1054	N/A	\$395
Z2066FFL	36 x 66 x 29.5-30	65	164	7	\$910	\$1027	N/A	\$395

Extended worksurface on right. **Full end panels on left and right. Can be placed next to** lateral files, storage cabinets, wardrobe units, credenzas and end-shelves. Corner has one grommet. Shipped RTA (ready to assemble).

- Modesty Panel is 1" off of ground.

LEFT EXTENDED CORNERS (CONNECTS ON EXTENDED SIDE)

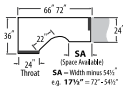
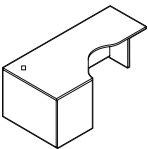

Left Extended Corner, 24" Throat

MODEL#	DIMENSIONS	FREIGHT CLASS	WT./LBS.	CUBIC FT.	1" TOP	1.5" TOP	GLAZE ADD	HP ADD
Z2472FNL	36 x 72 x 29.5-30	65	175	7	\$910	\$1033	N/A	\$411
Z2466FNL	36 x 66 x 29.5-30	65	167	7	\$910	\$1027	N/A	\$411

Extended worksurface on right. **Narrow end panel on right. Full end panel on left.** Connects to 30"D space saver connectables, 24"D returns, 24"D connectable tables or "D" and "P" islands with "T" or "H" bases. **Full end panel can be placed next to** lateral files, storage cabinets, wardrobe units, credenzas and end-shelves. Corner has one grommet. Shipped RTA (ready to assemble).

- Modesty Panel is 1" off of ground.
- **Z2466FNL** cannot accept pedestals.

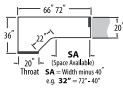
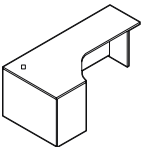

Left Extended Corner, 20" Throat

Z2072FNL	36 x 72 x 29.5-30	65	165	7	\$883	\$1027	N/A	\$395
Z2066FNL	36 x 66 x 29.5-30	65	158	7	\$883	\$1000	N/A	\$395

Extended worksurface on right. **Narrow end panel on right. Full end panel on left.** Connects to 24"D space saver connectables, 20"D returns, 20"D connectable tables or "D" and "P" islands with "T" or "H" bases. **Full end panel can be placed next to** lateral files, storage cabinets, wardrobe units, credenzas and end-shelves. Corner has one grommet. Shipped RTA (ready to assemble).

- Modesty Panel is 1" off of ground.
- *FNL end panels can be switched to make NFL.*

Required Specifications

Top finish
Top/edge detail
Lock finish
Base finish

Optional Specifications

HP laminate
Key #
Grommet position or power block cut-out

Handles
Modesty panel type

Accessories

Power block
Keyboard
Pencil drawer

LEFT EXTENDED CORNERS (CONNECTS ON THROAT SIDE)

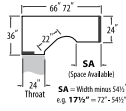
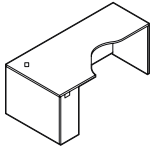

Left Extended Corner, 24" Throat

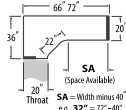
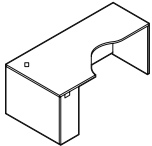

Left Extended Corner, 20" Throat

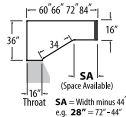
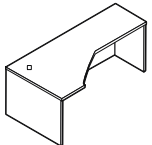
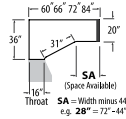
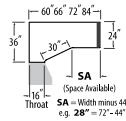

Left Extended Corner, 16" Throat

MODEL#	DIMENSIONS	FREIGHT CLASS	WT/LBS.	CUBIC FT.	1" TOP	1.5" TOP	GLAZE ADD	HP ADD
D x W x H								
Z2472NFL	36 x 72 x 29.5-30	65	175	7	\$910	\$1033	N/A	\$411
Z2466NFL	36 x 66 x 29.5-30	65	167	7	\$910	\$1027	N/A	\$411

Extended worksurface on right. **Narrow end panel on left. Full end panel on right.** Connects to 30"D space saver connectables, 30"D space saver returns, 24"D returns or 24"D connectable tables. **Full end panel can be placed next to** lateral files, storage cabinets, wardrobe units, credenzas and end-shelves. Corner has one grommet. Shipped RTA (ready to assemble).

- **Modesty Panel is 1" off of ground.**
- **Z2466NFL cannot accept pedestals.**

Z2072NFL	36 x 72 x 29.5-30	65	165	7	\$883	\$1027	N/A	\$411
Z2066NFL	36 x 66 x 29.5-30	65	158	7	\$883	\$1000	N/A	\$395

Extended worksurface on right. **Narrow end panel on left. Full end panel on right.** Connects to 24"D space saver connectables and 20"D returns. **Full end panel can be placed next to** lateral files, storage cabinets, wardrobe units, credenzas and end-shelves. Corner has one grommet. Shipped RTA (ready to assemble).

- **Modesty Panel is 1" off of ground.**
- *NFL end panels can be switched to make FNL.*

Z2484ECFL	36 x 84 x 29.5-30	65	196.35	8	\$913	\$1128	N/A	\$572
Z2472ECFL	36 x 72 x 29.5-30	65	176.40	7.50	\$817	\$1005	N/A	\$430
Z2466ECFL	36 x 66 x 29.5-30	70	168	7.50	\$777	\$951	N/A	\$430
Z2460ECFL	36 x 60 x 29.5-30	65	158.55	6	\$739	\$900	N/A	\$358

Z2084ECFL	36 x 84 x 29.5-30	65	184.80	8	\$910	\$1126	N/A	\$572
Z2072ECFL	36 x 72 x 29.5-30	70	168	7.50	\$813	\$1002	N/A	\$430
Z2066ECFL	36 x 66 x 29.5-30	70	159.60	7.50	\$774	\$949	N/A	\$430
Z2060ECFL	36 x 60 x 29.5-30	65	151.20	6	\$725	\$882	N/A	\$358

Z1684ECFL	36 x 84 x 29.5-30	70	175.35	8	\$907	\$1123	N/A	\$572
Z1672ECFL	36 x 72 x 29.5-30	70	159.60	7.50	\$810	\$999	N/A	\$430
Z1666ECFL	36 x 66 x 29.5-30	70	153.30	7.50	\$771	\$946	N/A	\$430
Z1660ECFL	36 x 60 x 29.5-30	65	147	6	\$719	\$875	N/A	\$358

Extended worksurface on right. **No narrow end panel on left. Full end panel on right.** Connects to returns and bridges with 16" throat on the left. **Full end panel can be placed next to** lateral files, storage cabinets, wardrobe units, credenzas and end-shelves. Corner has one grommet. **Does not accept pencil drawers.** Shipped RTA (ready to assemble).

Required Specifications

Top finish
Top/edge detail
Lock finish
Base finish

Optional Specifications

HP laminate Handles
Key # Modesty panel type
Grommet position or power block cut-out

Accessories

Power block
Keyboard
Pencil drawer

LEFT EXTENDED CORNERS (CONNECTS ON BOTH SIDES)

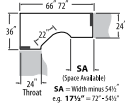
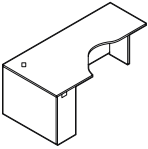

Left Extended Corner, 24" Throat

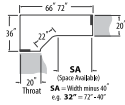
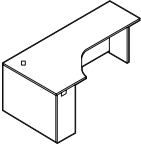

Left Extended Corner, 20" Throat

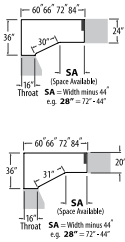
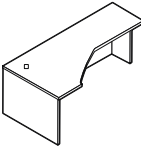

Left Extended Corner, 16" Throat

MODEL# DIMENSIONS FREIGHT CLASS WT/LBS. CUBIC FT. 1" TOP 1.5" TOP GLAZE ADD HP ADD

D x W x H									
Z2472NNL	36 x 72 x 29.5-30	65	166	7	\$883	\$1006	N/A	\$411	
Z2466NNL	36 x 66 x 29.5-30	65	158	7	\$883	\$1000	N/A	\$411	

Extended worksurface on right. **Narrow end panels on left and right.** Connects to 30"D space saver connectables, 30"D space saver returns, 24"D returns or 24"D connectable tables or "D" and "P" islands with "T" or "H" bases on either end. **Full end panel can be placed next to** lateral files, storage cabinets, wardrobe units, credenzas and end-shelves. Corner has one grommet. Shipped RTA (ready to assemble).

- **Modesty Panel is 1" off of ground.**
- **Z2466NNL cannot accept pedestals.**

Z2072NNL	36 x 72 x 29.5-30	65	160	7	\$856	\$1000	N/A	\$411	
Z2066NNL	36 x 66 x 29.5-30	70	152	7	\$856	\$974	N/A	\$395	

Extended worksurface on right. **Narrow end panels on left and right.** Connects to 24"D space saver connectables and 20"D returns, bridges or "D" and "P" islands with "T" or "H" bases one either end. **Full end panel can be placed next to** lateral files, storage cabinets, wardrobe units, credenzas and end-shelves. Corner has one grommet. Shipped RTA (ready to assemble).

- **Modesty Panel is 1" off of ground.**

Z2484ECNL	36 x 84 x 29.5-30	65	186.90	8	\$887	\$1103	N/A	\$572	
Z2472ECNL	36 x 72 x 29.5-30	70	168	7.50	\$789	\$979	N/A	\$430	
Z2466ECNL	36 x 66 x 29.5-30	70	158.55	7.50	\$750	\$924	N/A	\$430	
Z2460ECNL	36 x 60 x 29.5-30	65	150.15	6	\$702	\$858	N/A	\$358	
Z2084ECNL	36 x 84 x 29.5-30	70	178.50	8	\$883	\$1099	N/A	\$572	
Z2072ECNL	36 x 72 x 29.5-30	70	161.70	7.50	\$787	\$975	N/A	\$430	
Z2066ECNL	36 x 66 x 29.5-30	70	153.30	7.50	\$748	\$922	N/A	\$430	
Z2060ECNL	36 x 60 x 29.5-30	65	145.95	6	\$699	\$856	N/A	\$358	

Extended worksurface on right. **No narrow end panel on left. Narrow end panel on right.** Connects to returns and bridges with 16" throat on the left. **Full end panel can be placed next to** lateral files, storage cabinets, wardrobe units, credenzas and end-shelves. Corner has one grommet. **Does not accept pencil drawers.** Shipped RTA (ready to assemble).

RIGHT EXTENDED CORNERS (DOES NOT CONNECT)

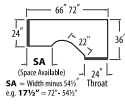
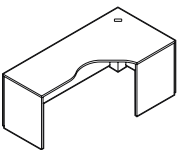

Right Extended Corner, 24" Throat Freestanding

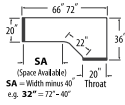
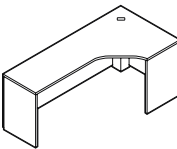

Right Extended Corner, 20" Throat

MODEL# DIMENSIONS FREIGHT CLASS WT/LBS. CUBIC FT. 1" TOP 1.5" TOP GLAZE ADD HP ADD

Z2472FFR	36 x 72 x 29.5-30	65	184	7	\$937	\$1060	N/A	\$411	
Z2466FFR	36 x 66 x 29.5-30	65	175	7	\$937	\$1055	N/A	\$411	

Extended worksurface on left. **Full end panels on left and right. Cannot be connected on left or right, due to full end panel.** Corner has one grommet. Shipped RTA (ready to assemble).

- **Modesty Panel is 1" off of ground.**
- **Z2466FFR cannot accept pedestals**

Z2072FFR	36 x 72 x 29.5-30	65	171	7	\$910	\$1054	N/A	\$395	
Z2066FFR	36 x 66 x 29.5-30	65	164	7	\$910	\$1027	N/A	\$395	

Extended worksurface on left. **Full end panels on left and right. Can be placed next to** lateral files, storage cabinets, wardrobe units, credenzas and end-shelves. Corner has one grommet. Shipped RTA (ready to assemble).

- **Modesty Panel is 1" off of ground.**

Required Specifications

- Top finish
- Top/edge detail
- Base finish

Optional Specifications

- HP laminate
- Modesty panel type
- Grommet position or power block cut-out

Accessories

- Power block
- Keyboard (*Not available on 16" throat*)
- Pencil drawer (*Not available on 16" throat*)

RIGHT EXTENDED CORNERS (CONNECTS ON THROAT SIDE)

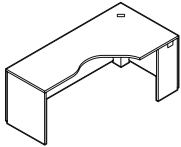

Right Extended Corner, 24" Throat

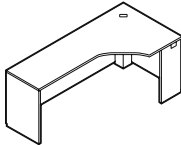
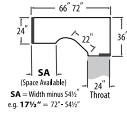

Right Extended Corner, 20" Throat

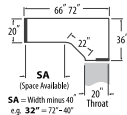

Right Extended Corner, 16" Throat

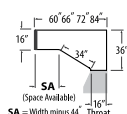
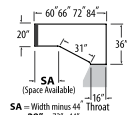
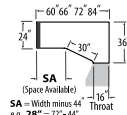

MODEL#	D x W x H	DIMENSIONS	FREIGHT CLASS	WT/LBS.	CUBIC FT.	1" TOP	1.5" TOP	GLAZE ADD	HP ADD
Z2472FNR	36 x 72 x 29.5-30	65	175	7	\$910	\$1033	N/A	\$411	
Z2466FNR	36 x 66 x 29.5-30	65	167	7	\$910	\$1027	N/A	\$411	

Extended worksurface on left. **Narrow end panel on right. Full end panel on left.** Connects to 30"D space saver connectables, 24"D returns, 24"D connectable tables or "D" and "P" islands with "T" or "H" bases. **Full end panel can be placed next to** lateral files, storage cabinets, wardrobe units, credenzas and end-shelves. Corner has one grommet. Shipped RTA (ready to assemble).

- Modesty Panel is 1" off of ground.
- Z2466FNR cannot accept pedestals.

Z2072FNR	36 x 72 x 29.5-30	65	165	7	\$883	\$1027	N/A	\$395
Z2066FNR	36 x 66 x 29.5-30	65	158	7	\$883	\$1000	N/A	\$395

Extended worksurface on left. **Narrow end panel on right. Full end panel on left.** Connects to 24"D space saver connectables, 20"D returns, 20"D connectable tables or "D" and "P" islands with "T" or "H" bases. **Full end panel can be placed next to** lateral files, storage cabinets, wardrobe units, credenzas and end-shelves. Corner has one grommet. Shipped RTA (ready to assemble).

- Modesty Panel is 1" off of ground.
- FNR end panels can be switched to make NFR.

Z2484ECFR	36 x 84 x 29.5-30	65	196.35	8	\$913	\$1128	N/A	\$572
Z2472ECFR	36 x 72 x 29.5-30	65	176.40	7.50	\$817	\$1005	N/A	\$430
Z2466ECFR	36 x 66 x 29.5-30	70	168	7.50	\$777	\$951	N/A	\$430
Z2460ECFR	36 x 60 x 29.5-30	65	158.55	6	\$739	\$900	N/A	\$358

Z2084ECFR	36 x 84 x 29.5-30	65	184.80	8	\$910	\$1126	N/A	\$572
Z2072ECFR	36 x 72 x 29.5-30	70	168	7.50	\$813	\$1002	N/A	\$430
Z2066ECFR	36 x 66 x 29.5-30	70	159.60	7.50	\$774	\$949	N/A	\$430
Z2060ECFR	36 x 60 x 29.5-30	65	151.20	6	\$725	\$882	N/A	\$358

Z1684ECFR	36 x 84 x 29.5-30	70	175.35	8	\$907	\$1123	N/A	\$572
Z1672ECFR	36 x 72 x 29.5-30	70	159.60	7.50	\$810	\$999	N/A	\$430
Z1666ECFR	36 x 66 x 29.5-30	70	153.30	7.50	\$771	\$946	N/A	\$430
Z1660ECFR	36 x 60 x 29.5-30	65	147	6	\$719	\$875	N/A	\$358

Extended worksurface on left. **No narrow end panel on right. Full end panel on left.** Connects to returns and bridges with 16" throat on the right. **Full end panel can be placed next to** lateral files, storage cabinets, wardrobe units, credenzas and end-shelves. Corner has one grommet. **Does not accept pencil drawers.** Shipped RTA (ready to assemble).

Required Specifications

Top finish
Top/edge detail
Base finish

Optional Specifications

HP laminate
Modesty panel type
Grommet position or power block cut-out

Accessories

Power block
Keyboard (Not available on 16" throat)
Pencil drawer (Not available on 16" throat)

RIGHT EXTENDED CORNERS (CONNECTS ON EXTENDED SIDE)

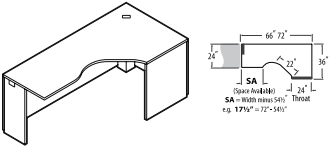

Right Extended Corner, 24" Throat

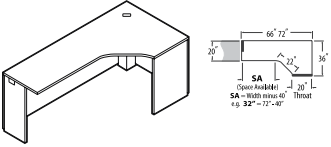

Right Extended Corner, 20" Throat

MODEL#	DIMENSIONS	FREIGHT CLASS	WT/LBS.	CUBIC FT.	1" TOP	1.5" TOP	GLAZE ADD	HP ADD
Z2472NFR	36 x 72 x 29.5-30	65	175	7	\$910	\$1033	N/A	\$411
Z2466NFR	36 x 66 x 29.5-30	65	167	7	\$910	\$1027	N/A	\$411

Extended worksurface on left. **Narrow end panel on left. Full end panel on right.** Connects to 30"D space saver connectables, 24"D returns, 24"D connectable tables, or "D" and "P" islands with "T" or "H" bases. **Full end panel can be placed next to** lateral files, storage cabinets, wardrobe units, credenzas and end-shelves. Corner has one grommet. Shipped RTA (ready to assemble).

- Modesty Panel is 1" off of ground.
- Z2466NFR cannot accept pedestals.

Z2072NFR	36 x 72 x 29.5-30	65	165	7	\$883	\$1027	N/A	\$411
Z2066NFR	36 x 66 x 29.5-30	65	158	7	\$883	\$1000	N/A	\$395

Extended worksurface on left. **Narrow end panel on left. Full end panel on right.** Connects to 24"D space saver connectables, 20"D returns or "D" and "P" islands with "T" or "H" bases. **Full end panel can be placed next to** lateral files, storage cabinets, wardrobe units, credenzas and end-shelves. Corner has one grommet. Shipped RTA (ready to assemble).

- Modesty Panel is 1" off of ground.
- NFR end panels can be switched to make FNR.

RIGHT EXTENDED CORNERS (CONNECTS ON BOTH SIDES)

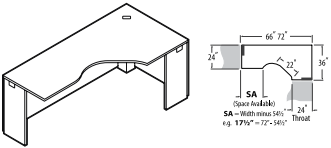

Left Extended Corner, 24" Throat

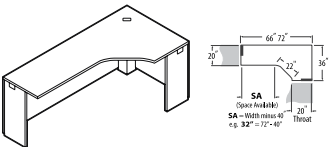

Right Extended Corner, 20" Throat

MODEL#	DIMENSIONS	FREIGHT CLASS	WT/LBS.	CUBIC FT.	1" TOP	1.5" TOP	GLAZE ADD	HP ADD
Z2472NNR	36 x 72 x 29.5-30	65	166	7	\$883	\$1006	N/A	\$411
Z2466NNR	36 x 66 x 29.5-30	65	158	7	\$883	\$1000	N/A	\$411

Extended worksurface on left. **Narrow end panels on left and right.** Connects to 30"D space saver connectables, 30"D space saver returns, 24"D returns, 24"D connectable tables or "D" and "P" islands with "T" or "H" bases on either end. Corner has one grommet. Shipped RTA (ready to assemble).

- Modesty Panel is 1" off of ground.
- Z2466NNR cannot accept pedestals.

Z2072NNR	36 x 72 x 29.5-30	65	160	7	\$856	\$1000	N/A	\$411
Z2066NNR	36 x 66 x 29.5-30	70	152	7	\$856	\$963	N/A	\$395

Extended worksurface on left. **Narrow end panels on left and right.** Connects to 24"D space saver connectables and 20"D returns, bridges or "D" and "P" islands with "T" or "H" bases one either end. **Full end panel can be placed next to** lateral files, storage cabinets, wardrobe units, credenzas and end-shelves. Corner has one grommet. Shipped RTA (ready to assemble).

- Modesty Panel is 1" off of ground.

Required Specifications

Top finish
Top/edge detail
Base finish

Optional Specifications

HP laminate
Modesty panel type
Grommet position or power block cut-out

Accessories

Power block
Keyboard
Pencil drawer

RIGHT EXTENDED CORNERS (CONNECTS ON BOTH SIDES)

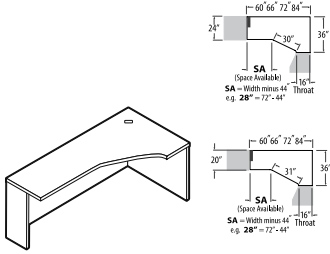

Right Extended Corner, 16" Throat

MODEL#	DIMENSIONS	FREIGHT CLASS	WT/LBS.	CUBIC FT.	1" TOP	1.5" TOP	GLAZE ADD	HP ADD
D x W x H								
Z2484ECNR	36 x 84 x 29.5-30	65	186.90	8	\$887	\$1103	N/A	\$572
Z2472ECNR	36 x 72 x 29.5-30	70	168	7.50	\$789	\$979	N/A	\$430
Z2466ECNR	36 x 66 x 29.5-30	70	158.55	7.50	\$750	\$924	N/A	\$430
Z2460ECNR	36 x 60 x 29.5-30	65	150.15	6	\$702	\$858	N/A	\$358
Z2084ECNR	36 x 84 x 29.5-30	70	178.50	8	\$883	\$1099	N/A	\$572
Z2072ECNR	36 x 72 x 29.5-30	70	161.70	7.50	\$787	\$975	N/A	\$430
Z2066ECNR	36 x 66 x 29.5-30	70	153.30	7.50	\$748	\$922	N/A	\$430
Z2060ECNR	36 x 60 x 29.5-30	65	145.95	6	\$699	\$856	N/A	\$358

Extended worksurface on left. **No narrow end panel on right. Narrow end panel on left.** Connects to returns and bridges with 16" throat on the right. **Full end panel can be placed next to lateral files, storage cabinets, wardrobe units, credenzas and end-shelves.** Corner has one grommet. **Does not accept pencil drawers.** Shipped RTA (ready to assemble).

FREESTANDING TABLES

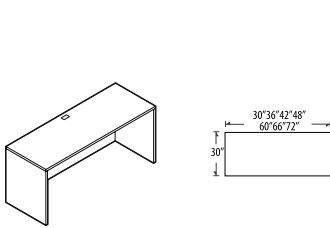

30" Deep Freestanding Table

MODEL#	DIMENSIONS	FREIGHT CLASS	WT/LBS.	CUBIC FT.	1" TOP	1.5" TOP	GLAZE ADD	HP ADD
Z3072T	29.7 x 72 x 29.5-30	65	176	6	\$775	\$895	N/A	\$385
Z3066T	29.7 x 66 x 29.5-30	65	166	6	\$775	\$888	N/A	\$385
Z3060T	29.7 x 60 x 29.5-30	60	159	5.25	\$707	\$813	N/A	\$358
Z3048T	29.7 x 48 x 29.5-30	65	135	5.25	\$639	\$733	N/A	\$303
Z3042T	29.7 x 42 x 29.5-30	65	125	5.25	\$639	\$726	N/A	\$274
Z3036T	29.7 x 36 x 29.5-30	65	111	4.30	\$565	\$645	N/A	\$248
Z3030T	29.7 x 30 x 29.5-30	65	100	3.60	\$530	\$596	N/A	\$221

Two full end panels. Cannot be connected on left or right side. Grommet in worksurface. Shipped RTA (ready to assemble).

- Modesty Panel is 1" off of ground.

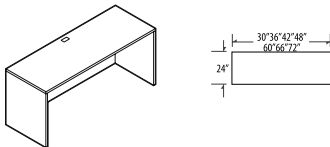

24" Deep Freestanding Table

Z2472T	24 x 72 x 29.5-30	65	152	6	\$695	\$808	N/A	\$287
Z2466T	24 x 66 x 29.5-30	65	144	6	\$695	\$808	N/A	\$287
Z2460T	24 x 60 x 29.5-30	65	133	5.25	\$633	\$719	N/A	\$264
Z2448T	24 x 48 x 29.5-30	65	114	4.30	\$571	\$646	N/A	\$210
Z2442T	24 x 42 x 29.5-30	65	105	4.30	\$571	\$637	N/A	\$176
Z2436T	24 x 36 x 29.5-30	65	95	4.20	\$510	\$565	N/A	\$132
Z2430T	24 x 30 x 29.5-30	65	85	3.60	\$484	\$525	N/A	\$132

Two full end panels. Cannot be connected on left or right side. Grommet in worksurface. Shipped RTA (ready to assemble).

- Modesty Panel is 1" off of ground.

Required Specifications

Top finish
Top/edge detail
Base finish

Optional Specifications

HP laminate
Modesty panel type
Grommet position or power block cut-out

Accessories

Power block
Keyboard (Not available on 16" throat)
Pencil drawer (Not available on 16" throat)

CONNECTABLE TABLES - LEFT

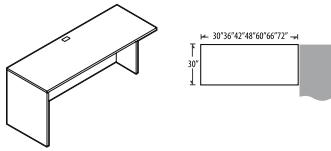

30" Deep Connectable Table - Left

MODEL#	DIMENSIONS D x W x H	FREIGHT CLASS	WT/LBS.	CUBIC FT.	1" TOP	1.5" TOP	GLAZE ADD	HP ADD
Z3072L	29.7 x 72 x 29.5-30	65	168	6	\$748	\$868	N/A	\$385
Z3066L	29.7 x 66 x 29.5-30	65	158	6	\$748	\$861	N/A	\$385
Z3060L	29.7 x 60 x 29.5-30	65	150	5.25	\$680	\$786	N/A	\$358
Z3048L	29.7 x 48 x 29.5-30	65	124	4.30	\$612	\$706	N/A	\$303
Z3042L	29.7 x 42 x 29.5-30	65	115	4.30	\$612	\$699	N/A	\$274
Z3036L	29.7 x 36 x 29.5-30	65	103	4.20	\$539	\$620	N/A	\$248
Z3030L	29.7 x 30 x 29.5-30	65	92	3.60	\$504	\$570	N/A	\$221

Full end panel on left. Right narrow end panel connects to 30"D center/right connectable table, or at 90° angle to a freestanding table; and "D" islands or "P" islands with "T" and "H" bases. Grommet in worksurface. Shipped RTA (ready to assemble).

- Modesty Panel is 1" off of ground.

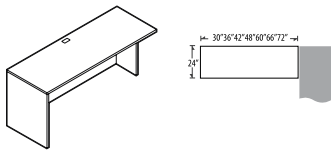

24" Deep Connectable Table - Left

Z2472L	24 x 72 x 29.5-30	65	144	6	\$660	\$775	N/A	\$287
Z2466L	24 x 66 x 29.5-30	65	135	6	\$660	\$760	N/A	\$287
Z2460L	24 x 60 x 29.5-30	65	125	5.25	\$598	\$685	N/A	\$264
Z2448L	24 x 48 x 29.5-30	65	106	4.30	\$545	\$620	N/A	\$210
Z2442L	24 x 42 x 29.5-30	65	95	3.80	\$545	\$611	N/A	\$176
Z2436L	24 x 36 x 29.5-30	65	86	3.30	\$477	\$531	N/A	\$132
Z2430L	24 x 30 x 29.5-30	70	77	3.60	\$450	\$492	N/A	\$132

Full end panel on left. Right narrow end panel connects to 24"D center/right connectable table, or at 90° angle to a freestanding table; 24"D extended corners or at the end of a straight run; "D" islands or "P" islands with "T" and "H" bases. Grommet in worksurface. Shipped RTA (ready to assemble).

- Modesty Panel is 1" off of ground.

CONNECTABLE TABLES - RIGHT

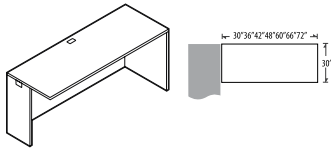

30" Deep Connectable Table - Right

MODEL#	DIMENSIONS D x W x H	FREIGHT CLASS	WT/LBS.	CUBIC FT.	1" TOP	1.5" TOP	GLAZE ADD	HP ADD
Z3072R	29.7 x 72 x 29.5-30	65	168	6	\$748	\$868	N/A	\$385
Z3066R	29.7 x 66 x 29.5-30	65	158	6	\$748	\$861	N/A	\$385
Z3060R	29.7 x 60 x 29.5-30	65	150	5.25	\$680	\$786	N/A	\$358
Z3048R	29.7 x 48 x 29.5-30	65	124	4.30	\$612	\$706	N/A	\$303
Z3042R	29.7 x 42 x 29.5-30	65	115	4.30	\$612	\$699	N/A	\$274
Z3036R	29.7 x 36 x 29.5-30	65	103	4.20	\$539	\$620	N/A	\$248
Z3030R	29.7 x 30 x 29.5-30	65	92	3.60	\$504	\$570	N/A	\$221

Full end panel on right. Left narrow end panel connects to 30"D center/right connectable table, or at 90° angle to a freestanding table; and "D" islands or "P" islands with "T" and "H" bases. Grommet in worksurface. Shipped RTA (ready to assemble).

- Modesty Panel is 1" off of ground.

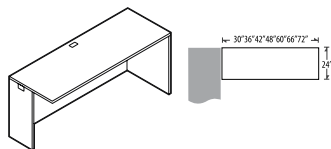

24" Deep Connectable Table - Right

Z2472R	24 x 72 x 29.5-30	65	144	6	\$660	\$775	N/A	\$287
Z2466R	24 x 66 x 29.5-30	65	135	6	\$660	\$760	N/A	\$287
Z2460R	24 x 60 x 29.5-30	65	125	5.25	\$598	\$685	N/A	\$264
Z2448R	24 x 48 x 29.5-30	65	106	4.30	\$545	\$620	N/A	\$210
Z2442R	24 x 42 x 29.5-30	65	95	3.80	\$545	\$611	N/A	\$176
Z2436R	24 x 36 x 29.5-30	65	86	3.30	\$477	\$531	N/A	\$132
Z2430R	24 x 30 x 29.5-30	70	77	3.60	\$450	\$492	N/A	\$132

Full end panel on right. Left narrow end panel connects to 24"D center/right connectable table, or at 90° angle to a freestanding table; 24"D extended corners or at the end of a straight run; "D" islands or "P" islands with "T" and "H" bases. Grommet in worksurface. Shipped RTA (ready to assemble).

- Modesty Panel is 1" off of ground.

Required Specifications

Top finish
Top/edge detail
Base finish

Optional Specifications

HP laminate
Modesty panel type
Grommet position or power block cut-out

Accessories

Power block
Keyboard
Pencil drawer

CONNECTABLE TABLES

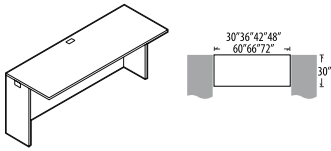

30" Deep Connectable Table

MODEL#	DIMENSIONS	FREIGHT CLASS	WT/LBS.	CUBIC FT.	1" TOP	1.5" TOP	GLAZE ADD	HP ADD
D x W x H								
Z3072N	29.7 x 72 x 29.5-30	65	159	6	\$720	\$841	N/A	\$385
Z3066N	29.7 x 66 x 29.5-30	65	149	6	\$720	\$835	N/A	\$385
Z3060N	29.7 x 60 x 29.5-30	65	142	5.25	\$645	\$752	N/A	\$358
Z3048N	29.7 x 48 x 29.5-30	65	116	4.30	\$565	\$658	N/A	\$303
Z3042N	29.7 x 42 x 29.5-30	65	106	3.80	\$565	\$651	N/A	\$274
Z3036N	29.7 x 36 x 29.5-30	65	94	3.30	\$504	\$585	N/A	\$248
Z3030N	29.7 x 30 x 29.5-30	65	83	3.60	\$477	\$543	N/A	\$221

Narrow end panels on both sides connect to **30"D** worksurfaces, "D" islands or "P" islands with "T" and "H" bases; or at 90° angle to freestanding table(s). Grommet in worksurface. Shipped RTA (ready to assemble).

- Modesty Panel is 1" off of ground.

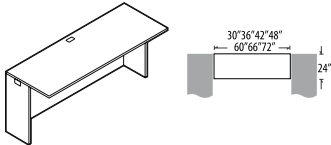

24" Deep Connectable Table

Z2472N	24 x 72 x 29.5-30	65	135	6	\$627	\$740	N/A	\$287
Z2466N	24 x 66 x 29.5-30	70	127	6	\$627	\$726	N/A	\$287
Z2460N	24 x 60 x 29.5-30	65	116	4.50	\$565	\$651	N/A	\$264
Z2448N	24 x 48 x 29.5-30	65	97	4.30	\$510	\$585	N/A	\$210
Z2442N	24 x 42 x 29.5-30	65	87	3.80	\$510	\$571	N/A	\$176
Z2436N	24 x 36 x 29.5-30	65	77	3.30	\$442	\$496	N/A	\$132
Z2430N	24 x 30 x 29.5-30	70	68	3.60	\$416	\$457	N/A	\$132

Narrow end panels on both sides connect to **24"D** worksurfaces, "D" islands or "P" islands with "T" and "H" bases; or at 90° angle to freestanding table(s). Grommet in worksurface. Shipped RTA (ready to assemble).

- Modesty Panel is 1" off of ground.

SPACE SAVER CONNECTABLE TABLES - LEFT

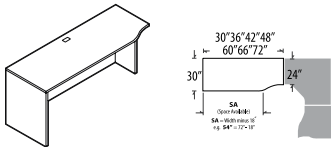

30" Deep Space Saver Connectable Table - Left

MODEL#	DIMENSIONS	FREIGHT CLASS	WT/LBS.	CUBIC FT.	1" TOP	1.5" TOP	GLAZE ADD	HP ADD
Z3072LK	29.7 x 72 x 29.5-30	65	161	6	\$762	\$891	N/A	\$385
Z3066LK	29.7 x 66 x 29.5-30	65	151	6	\$762	\$885	N/A	\$385
Z3060LK	29.7 x 60 x 29.5-30	65	144	5.25	\$695	\$812	N/A	\$358
Z3048LK	29.7 x 48 x 29.5-30	65	118	4.30	\$627	\$729	N/A	\$303
Z3042LK	29.7 x 42 x 29.5-30	65	107	3.80	\$627	\$723	N/A	\$274
Z3036LK	29.7 x 36 x 29.5-30	70	96	4.30	\$552	\$641	N/A	\$248
Z3030LK	29.7 x 30 x 29.5-30	65	85	3.60	\$518	\$596	N/A	\$221

Full end panel on left. Narrow right end panel connects to any corner unit with a 24" throat. Grommet in worksurface. Shipped RTA (ready to assemble).

- Modesty Panel is 1" off of ground.

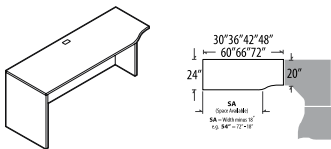

24" Deep Space Saver Connectable Table - Left

Z2472LK	24 x 72 x 29.5-30	65	140	6	\$680	\$803	N/A	\$287
Z2466LK	24 x 66 x 29.5-30	70	134	6	\$680	\$790	N/A	\$287
Z2460LK	24 x 60 x 29.5-30	65	123	5.25	\$620	\$716	N/A	\$264
Z2448LK	24 x 48 x 29.5-30	65	104	4.30	\$565	\$648	N/A	\$210
Z2442LK	24 x 42 x 29.5-30	65	94	3.80	\$565	\$642	N/A	\$176
Z2436LK	24 x 36 x 29.5-30	65	85	3.30	\$497	\$561	N/A	\$132
Z2430LK	24 x 30 x 29.5-30	70	75	3.60	\$471	\$522	N/A	\$132

Full end panel on left. Narrow right end panel connects to any corner unit with a 20" throat. Grommet in worksurface. Shipped RTA (ready to assemble).

- Modesty Panel is 1" off of ground.

Required Specifications

- Top finish
- Top/edge detail
- Base finish

Optional Specifications

- HP laminate
- Modesty panel type
- Grommet position or power block cut-out

Accessories

- Power block
- Keyboard
- Pencil drawer

SPACE SAVER CONNECTABLE TABLES - RIGHT

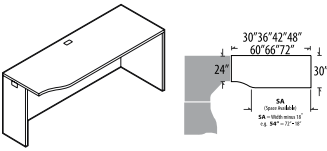

30" Deep Space Saver Connectable Table - Right

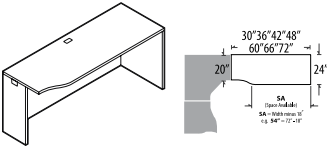

24" Deep Space Saver Connectable Table - Right

MODEL#	DIMENSIONS	FREIGHT CLASS	WT./LBS.	CUBIC FT.	1"TOP	1.5" TOP	GLAZE ADD	HP ADD
Z3072RK	29.7 x 72 x 29.5-30	65	161	6	\$762	\$891	N/A	\$385
Z3066RK	29.7 x 66 x 29.5-30	65	151	6	\$762	\$885	N/A	\$385
Z3060RK	29.7 x 60 x 29.5-30	65	144	5.25	\$695	\$812	N/A	\$358
Z3048RK	29.7 x 48 x 29.5-30	65	119	4.30	\$627	\$729	N/A	\$303
Z3042RK	29.7 x 42 x 29.5-30	65	107	3.80	\$627	\$723	N/A	\$274
Z3036RK	29.7 x 36 x 29.5-30	70	96	4.30	\$552	\$641	N/A	\$248
Z3030RK	29.7 x 30 x 29.5-30	65	85	3.60	\$518	\$596	N/A	\$221

Full end panel on right. Narrow left end panel connects to any corner unit with a 24" throat. Grommet in worksurface. Shipped RTA (ready to assemble).

- Modesty Panel is 1" off of ground.

Z2472RK	24 x 72 x 29.5-30	65	142	6	\$680	\$803	N/A	\$287
Z2466RK	24 x 66 x 29.5-30	70	134	6	\$680	\$790	N/A	\$287
Z2460RK	24 x 60 x 29.5-30	65	123	5.25	\$620	\$716	N/A	\$264
Z2448RK	24 x 48 x 29.5-30	65	104	4.30	\$565	\$648	N/A	\$210
Z2442RK	24 x 42 x 29.5-30	65	94	3.80	\$565	\$642	N/A	\$176
Z2436RK	24 x 36 x 29.5-30	65	85	3.30	\$497	\$561	N/A	\$132
Z2430RK	24 x 30 x 29.5-30	70	75	3.60	\$471	\$522	N/A	\$132

Full end panel on right. Narrow left end panel connects to any corner unit with a 20" throat. Grommet in worksurface. Shipped RTA (ready to assemble).

- Modesty Panel is 1" off of ground.

SPACE SAVER CONNECTABLE TABLES

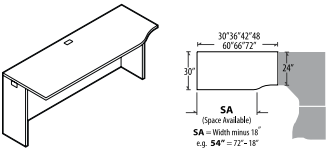

30" Deep Space Saver Connectable Table

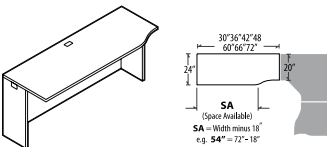

24" Deep Space Saver Connectable Table

MODEL#	DIMENSIONS	FREIGHT CLASS	WT./LBS.	CUBIC FT.	1"TOP	1.5" TOP	GLAZE ADD	HP ADD
Z3072LN	29.7 x 72 x 29.5-30	65	153	6	\$734	\$863	N/A	\$385
Z3066LN	29.7 x 66 x 29.5-30	65	143	6	\$734	\$857	N/A	\$385
Z3060LN	29.7 x 60 x 29.5-30	65	136	5.25	\$660	\$778	N/A	\$358
Z3048LN	29.7 x 48 x 29.5-30	65	110	4.30	\$578	\$681	N/A	\$303
Z3042LN	29.7 x 42 x 29.5-30	65	100	3.80	\$578	\$675	N/A	\$274
Z3036LN	29.7 x 36 x 29.5-30	65	88	3.30	\$518	\$608	N/A	\$248
Z3030LN	29.7 x 30 x 29.5-30	70	77	3.60	\$490	\$568	N/A	\$221

Narrow end panels on both sides. Connects the **right end only** to any corner unit with a 24" throat. Left end allows the continuation of additional 30" connectable center or left connectable worksurface. Grommet in worksurface. Shipped RTA (ready to assemble).

- Modesty Panel is 1" off of ground.

Z2472LN	24 x 72 x 29.5-30	70	134	6	\$645	\$769	N/A	\$287
Z2466LN	24 x 66 x 29.5-30	70	125	6	\$645	\$756	N/A	\$287
Z2460LN	24 x 60 x 29.5-30	70	115	5.25	\$586	\$689	N/A	\$264
Z2448LN	24 x 48 x 29.5-30	70	96	4.30	\$530	\$614	N/A	\$210
Z2442LN	24 x 42 x 29.5-30	70	85	3.80	\$530	\$608	N/A	\$176
Z2436LN	24 x 36 x 29.5-30	65	76	3.30	\$464	\$527	N/A	\$132
Z2430LN	24 x 30 x 29.5-30	70	67	3.60	\$436	\$488	N/A	\$132

Narrow end panels on both sides. Connects the **right end only** to any corner unit with a 24" throat. Left end allows the continuation of additional 24" connectable center or left connectable worksurface. Grommet in worksurface. Shipped RTA (ready to assemble).

- Modesty Panel is 1" off of ground.

Required Specifications

- Top finish
- Top/edge detail
- Base finish

Optional Specifications

- HP laminate
- Modesty panel type
- Grommet position or power block cut-out

Accessories

- Power block
- Keyboard
- Pencil drawer

SPACE SAVER CONNECTABLE TABLES

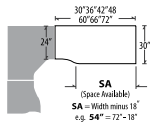
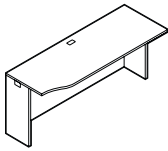

30" Deep Space Saver Connectable Table

MODEL#	DIMENSIONS	FREIGHT CLASS	WT/LBS.	CUBIC FT.	1" TOP	1.5" TOP	GLAZE ADD	HP ADD
Z3072RN	29.7 x 72 x 29.5-30	65	153	6	\$734	\$863	N/A	\$385
Z3066RN	29.7 x 66 x 29.5-30	65	143	6	\$734	\$857	N/A	\$385
Z3060RN	29.7 x 60 x 29.5-30	65	136	5.25	\$660	\$778	N/A	\$358
Z3048RN	29.7 x 48 x 29.5-30	65	110	4.30	\$578	\$681	N/A	\$303
Z3042RN	29.7 x 42 x 29.5-30	65	99	3.80	\$578	\$675	N/A	\$274
Z3036RN	29.7 x 36 x 29.5-30	65	88	3.30	\$518	\$608	N/A	\$248
Z3030RN	29.7 x 30 x 29.5-30	70	77	3.60	\$490	\$568	N/A	\$221

Narrow end panels on both sides. Connects the **left end only** to any corner unit with a 24" throat. Right end allows the continuation of additional 30" connectable center or right connectable worksurface. Grommet in worksurface. Shipped RTA (ready to assemble).

- Modesty Panel is 1" off of ground.

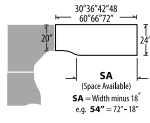
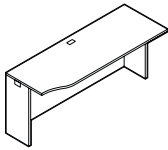

24" Deep Space Saver Connectable Table

Z2472RN	24 x 72 x 29.5-30	70	134	6	\$645	\$769	N/A	\$287
Z2466RN	24 x 66 x 29.5-30	70	125	6	\$645	\$756	N/A	\$287
Z2460RN	24 x 60 x 29.5-30	70	115	5.25	\$586	\$689	N/A	\$264
Z2448RN	24 x 48 x 29.5-30	70	95	4.30	\$530	\$614	N/A	\$210
Z2442RN	24 x 42 x 29.5-30	70	85	3.80	\$530	\$608	N/A	\$176
Z2436RN	24 x 36 x 29.5-30	65	76	3.30	\$464	\$527	N/A	\$132
Z2430RN	24 x 30 x 29.5-30	70	67	3.60	\$436	\$488	N/A	\$132

Narrow end panels on both sides. Connects the **left end only** to any corner unit with a 20" throat. Right end allows the continuation of additional 30" connectable center or right connectable worksurface. Grommet in worksurface. Shipped RTA (ready to assemble).

- Modesty Panel is 1" off of ground.

EXTENDED CORNER ISLANDS

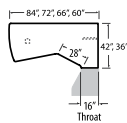
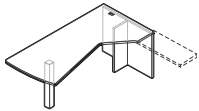

Extended Corner Island - LEFT Full End Panel & Post (T-Base)*

MODEL#	DIMENSIONS	FREIGHT CLASS	WT/LBS.	CUBIC FT.	1" TOP	1.5" TOP	GLAZE ADD	HP ADD
Z4284EDTL	42 x 84 x 29.5-30	70	180.60	10.76	\$922	\$1160	N/A	\$762
Z4272EDTL	42 x 72 x 29.5-30	70	164.85	9.50	\$867	\$1079	N/A	\$572
Z3672EDTL	36 x 72 x 29.5-30	70	139.65	8.76	\$791	\$939	N/A	\$430
Z3666EDTL	36 x 66 x 29.5-30	70	133.35	8.76	\$758	\$904	N/A	\$430
Z3660EDTL	36 x 60 x 29.5-30	70	127.05	6.50	\$721	\$869	N/A	\$358

Extended island worksurface on **left**. Connects to returns or bridges with a 16" throat on the right. **Not freestanding.** Grommet in worksurface. Shipped RTA (ready to assemble).

- Post is shipped in separate carton.

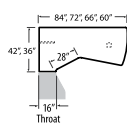
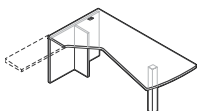

Extended Corner Island - RIGHT Full End Panel & Post (T-Base)*

Z4284EDTR	42 x 84 x 29.5-30	70	180.60	10.76	\$922	\$1160	N/A	\$762
Z4272EDTR	42 x 72 x 29.5-30	70	164.85	9.50	\$867	\$1079	N/A	\$572
Z3672EDTR	36 x 72 x 29.5-30	70	139.65	8.76	\$791	\$939	N/A	\$430
Z3666EDTR	36 x 66 x 29.5-30	70	133.35	8.76	\$758	\$904	N/A	\$430
Z3660EDTR	36 x 60 x 29.5-30	70	127.05	6.50	\$721	\$869	N/A	\$358

Extended island worksurface on **right**. Connects to returns or bridges with a 16" throat on the left. **Not freestanding.** Grommet in worksurface. Shipped RTA (ready to assemble).

- Post is shipped in separate carton.

Required Specifications

Top finish
Top/edge detail
Base finish

Optional Specifications

HP laminate
Modesty panel type
Grommet position or power block cut-out

Accessories

Power block
Keyboard
Pencil drawer

EXTENDED CORNER ISLANDS (WITH FAUX PEDESTAL)

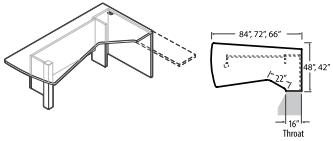

**Extended Corner Island - LEFT
Faux Pedestal and Post**

MODEL#	DIMENSIONS	FREIGHT CLASS	WT/LBS.	CUBIC FT.	1" TOP	1.5" TOP	GLAZE ADD	HP ADD
Z4884EDFL	48 x 84 x 29.5-30	70	214.20	12	\$1154	\$1420	\$517	\$762
Z4872EDFL	48 x 72 x 29.5-30	70	192.15	10.76	\$1070	\$1302	\$427	\$572
Z4284EDFL	42 x 84 x 29.5-30	70	186.90	10.76	\$1083	\$1321	\$517	\$762
Z4272EDFL	42 x 72 x 29.5-30	70	168	8.76	\$1007	\$1215	\$427	\$572
Z4266EDFL	42 x 66 x 29.5-30	70	158.55	8.76	\$967	\$1160	\$382	\$572

Extended island worksurface on **left**. Connects to returns or bridges with a 16" throat on the right. **Not freestanding**. Faux pedestal on the **right** is ideal for concealing a CPU. ¾ modesty panel is standard. Grommet in worksurface. Shipped RTA (ready to assemble) in 2 cartons.

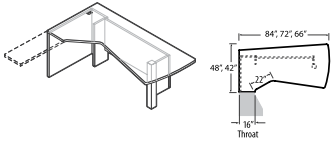

**Extended Corner Island - RIGHT
Faux Pedestal and Post**

Z4884EDFR	48 x 84 x 29.5-30	70	214.20	12	\$1154	\$1420	\$517	\$762
Z4872EDFR	48 x 72 x 29.5-30	70	192.15	10.76	\$1070	\$1302	\$427	\$572
Z4284EDFR	42 x 84 x 29.5-30	70	186.90	10.76	\$1083	\$1321	\$517	\$762
Z4272EDFR	42 x 72 x 29.5-30	70	168	8.76	\$1007	\$1215	\$427	\$572
Z4266EDFR	42 x 66 x 29.5-30	70	158.55	8.76	\$967	\$1160	\$382	\$572

Extended island worksurface on **right**. Connects to returns or bridges with a 16" throat on the right. **Not freestanding**. Faux pedestal on the **left** is ideal for concealing a CPU. ¾ modesty panel is standard. Grommet in worksurface. Shipped RTA (ready to assemble) in 2 cartons.



EXTENDED CORNER ISLANDS (WITH RECESSED MODESTY)

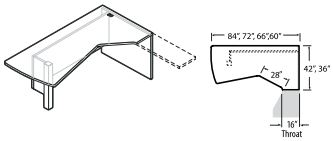

**Extended Corner Island - LEFT
Recessed Modesty and Post**

MODEL#	DIMENSIONS	FREIGHT CLASS	WT/LBS.	CUBIC FT.	1" TOP	1.5" TOP	GLAZE ADD	HP ADD
Z4284EDRL	42 x 84 x 29.5-30	70	199	10.76	\$1023	\$1262	\$608	\$762
Z4272EDRL	42 x 72 x 29.5-30	70	180	9.50	\$961	\$1172	\$554	\$572
Z3672EDRL	36 x 72 x 29.5-30	70	154	8.76	\$851	\$1031	\$554	\$430
Z3666EDRL	36 x 66 x 29.5-30	70	144	8.76	\$819	\$985	\$509	\$430
Z3660EDRL	36 x 60 x 29.5-30	70	136	6.50	\$787	\$941	\$465	\$358

Extended island worksurface on **left**. Connects to returns or bridges with a 16" throat on the right. **Not freestanding**. Grommet in worksurface. ¾ **recessed** modesty panel is standard. Shipped RTA (ready to assemble) in 2 cartons.

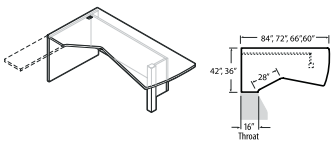

**Extended Corner Island - RIGHT
Recessed Modesty and Post**

Z4284EDRR	42 x 84 x 29.5-30	70	199	10.76	\$1023	\$1262	\$608	\$762
Z4272EDRR	42 x 72 x 29.5-30	70	180	9.50	\$961	\$1172	\$554	\$572
Z3672EDRR	36 x 72 x 29.5-30	70	154	8.76	\$851	\$1031	\$554	\$430
Z3666EDRR	36 x 66 x 29.5-30	70	144	8.76	\$819	\$985	\$509	\$430
Z3660EDRR	36 x 60 x 29.5-30	70	136	6.50	\$787	\$941	\$465	\$358

Extended island worksurface on **right**. Connects to returns or bridges with a 16" throat on the left. **Not freestanding**. Grommet in worksurface. ¾ **recessed** modesty panel is standard. Shipped RTA (ready to assemble) in 2 cartons.

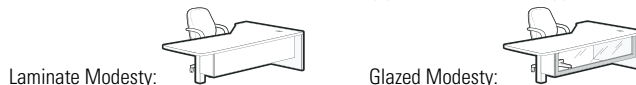

Required Specifications

- Top finish
- Top/edge detail
- Base finish
- Monopost finish*

Optional Specifications

- HP laminate
- Modesty panel type
- Grommet position or power block cut-out

Accessories

- Power block
- Keyboard
- Pencil drawer

EXTENDED CORNER ISLANDS (WITH FLUSH MODESTY)	MODEL#	DIMENSIONS	FREIGHT CLASS	WT/LBS.	CUBIC FT.	1" TOP	1.5" TOP	GLAZE ADD	HP ADD
	Z4284EDML	42 x 84 x 29.5-30	70	208.95	10.76	\$1037	\$1276	\$608	\$762
	Z4272EDML	42 x 72 x 29.5-30	70	183.75	9.50	\$972	\$1183	\$554	\$572
	Z3672EDML	36 x 72 x 29.5-30	70	158.55	8.76	\$860	\$1036	\$554	\$430
	Z3666EDML	36 x 66 x 29.5-30	70	150.15	8.76	\$824	\$1010	\$509	\$430
	Z3660EDML	36 x 60 x 29.5-30	70	141.75	6.50	\$803	\$948	\$465	\$358

**Extended Corner Island - LEFT
Flush Modesty and Post**

Extended island worksurface on **left**. Connects to returns or bridges with a 16" throat on the right. **Not freestanding.** Grommet in worksurface. $\frac{3}{4}$ flush modesty panel is standard. Shipped RTA (ready to assemble) in 2 cartons.

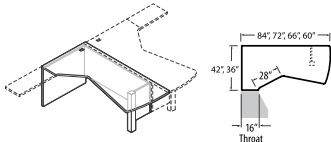

**Extended Corner Island - RIGHT
Flush Modesty and Post**

Extended island worksurface on **right**. Connects to returns or bridges with a 16" throat on the left. **Not freestanding.** Grommet in worksurface. $\frac{3}{4}$ flush modesty panel is standard. Shipped RTA (ready to assemble) in 2 cartons.

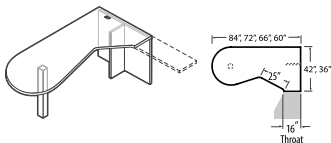
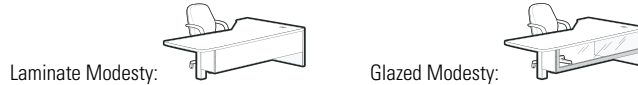

**Extended Corner "P" Island - LEFT
Full End Panel & Post (T-Base)**

Extended island worksurface on **left**. Connects to returns or bridges with a 16" throat on the right. **Not freestanding.** Grommet in worksurface. Shipped RTA (ready to assemble).

- Post is shipped in separate carton.

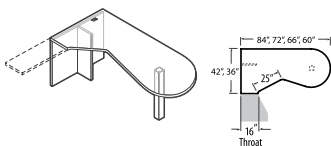

**Extended Corner "P" Island - RIGHT
Full End Panel & Post (T-Base)**

Extended island worksurface on **right**. Connects to returns or bridges with a 16" throat on the left. **Not freestanding.** Grommet in worksurface. Shipped RTA (ready to assemble).

- Post is shipped in separate carton.

EXTENDED CORNER ISLANDS (WITH FAUX MODESTY)	MODEL#	DIMENSIONS	FREIGHT CLASS	WT/LBS.	CUBIC FT.	1" TOP	1.5" TOP	GLAZE ADD	HP ADD
	Z4884EPFL	48 x 84 x 29.5-30	70	217	12	\$1154	\$1418	\$517	\$762
	Z4872EPFL	48 x 72 x 29.5-30	70	194	10.50	\$1069	\$1300	\$427	\$572
	Z4284EPFL	42 x 84 x 29.5-30	70	191	10.76	\$1083	\$1320	\$517	\$762
	Z4272EPFL	42 x 72 x 29.5-30	70	172	8.76	\$1006	\$1214	\$427	\$572
	Z4266EPFL	42 x 66 x 29.5-30	70	160	8.76	\$966	\$1158	\$382	\$572

**Extended Corner "P" Island - LEFT
Faux Pedestal and Post**

Extended island worksurface on **left**. Connects to returns or bridges with a 16" throat on the right. **Not freestanding.** Faux pedestal on the **right** is ideal for concealing a CPU. $\frac{3}{4}$ modesty panel is standard. Grommet in worksurface. Shipped RTA (ready to assemble) in 2 cartons.



Required Specifications

- Top finish
- Top/edge detail
- Base finish
- Monopost finish

Optional Specifications

- HP laminate
- Glazing - modesty panel
- Grommet position or power block cut-out

Accessories

- Power block
- Keyboard
- Pencil drawer

EXTENDED CORNER ISLANDS (WITH FAUX MODESTY)

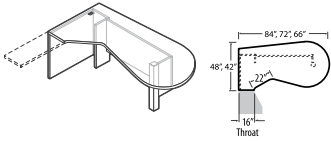

Extended Corner "P" Island - RIGHT Faux Pedestal and Post

MODEL#	DIMENSIONS	FREIGHT CLASS	WT/LBS.	CUBIC FT.	1" TOP	1.5" TOP	GLAZE ADD	HP ADD	
D x W x H									
Z4884EPFR	48 x 84 x 29.5-30	70	217	12	\$1154	\$1418	\$517	\$762	
Z4872EPFR	48 x 72 x 29.5-30	70	194	10.50	\$1069	\$1300	\$427	\$572	
Z4284EPFR	42 x 84 x 29.5-30	70	191	10.76	\$1083	\$1320	\$517	\$762	
Z4272EPFR	42 x 72 x 29.5-30	70	172	8.76	\$1006	\$1214	\$427	\$572	
Z4266EPFR	42 x 66 x 29.5-30	70	160	8.76	\$966	\$1158	\$382	\$572	

Extended island worksurface on **left**. Connects to returns or bridges with a 16" throat on the right. **Not freestanding.** Faux pedestal on the **right** is ideal for concealing a CPU. ¾ modesty panel is standard. Grommet in worksurface. Shipped RTA (ready to assemble) in 2 cartons.

Laminate Modesty:



Glazed Modesty:

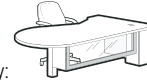

EXTENDED CORNER ISLANDS (WITH RECESSED MODESTY)

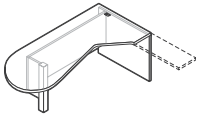

Extended Corner "P" Island - LEFT Recessed Modesty and Post

MODEL#	DIMENSIONS	FREIGHT CLASS	WT/LBS.	CUBIC FT.	1" TOP	1.5" TOP	GLAZE ADD	HP ADD
Z4284EPRL	42 x 84 x 29.5-30	70	199.50	10.76	\$1020	\$1258	\$608	\$762
Z3684EPRL	36 x 84 x 29.5-30	70	173.25	9.50	\$925	\$1158	\$608	\$572
Z3672EPRL	36 x 72 x 29.5-30	70	156.45	8.76	\$851	\$1031	\$554	\$430
Z3666EPRL	36 x 66 x 29.5-30	70	149.10	8.76	\$829	\$999	\$509	\$430
Z3660EPRL	36 x 60 x 29.5-30	70	140.70	6.50	\$793	\$950	\$465	\$358

Extended island worksurface on **left**. Connects to returns or bridges with a 16" throat on the right. **Not freestanding.** Grommet in worksurface. ¾ **recessed** modesty panel is standard. Shipped RTA (ready to assemble) in 2 cartons.

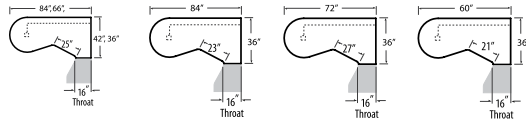

Laminate Modesty:

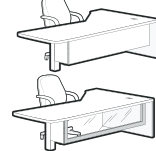

Glazed Modesty:

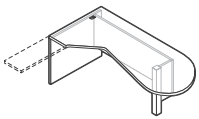

Extended Corner "P" Island - RIGHT Recessed Modesty and Post

Z4284EPRR	42 x 84 x 29.5-30	70	199.50	10.76	\$1020	\$1258	\$608	\$762
Z3684EPRR	36 x 84 x 29.5-30	70	173.25	9.50	\$925	\$1158	\$608	\$572
Z3672EPRR	36 x 72 x 29.5-30	70	156.45	8.76	\$851	\$1031	\$554	\$430
Z3666EPRR	36 x 66 x 29.5-30	70	149.10	8.76	\$829	\$999	\$509	\$430
Z3660EPRR	36 x 60 x 29.5-30	70	140.70	6.50	\$793	\$950	\$465	\$358

Extended island worksurface on **right**. Connects to returns or bridges with a 16" throat on the right. **Not freestanding.** Grommet in worksurface. ¾ **recessed** modesty panel is standard. Shipped RTA (ready to assemble) in 2 cartons.

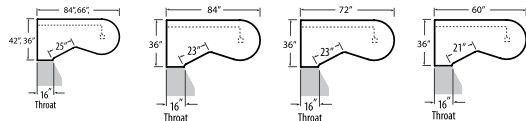

Laminate Modesty:

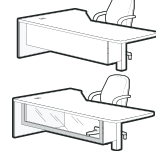

Glazed Modesty:

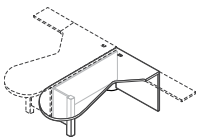

Extended Corner "P" Island - LEFT Flush Modesty and Post

Z4284EPML	42 x 84 x 29.5-30	70	200	10.76	\$1033	\$1271	\$608	\$762
Z3684EPML	36 x 84 x 29.5-30	70	172	9.50	\$934	\$1146	\$608	\$572
Z3672EPML	36 x 72 x 29.5-30	70	156	8.76	\$857	\$1036	\$554	\$430
Z3666EPML	36 x 66 x 29.5-30	70	150	8.76	\$823	\$972	\$509	\$430
Z3660EPML	36 x 60 x 29.5-30	70	141	6.50	\$799	\$955	\$465	\$358

Extended island worksurface on **left**. Connects to returns or bridges with a 16" throat on the right. **Not freestanding.** Grommet in worksurface. ¾ **flush** modesty panel is standard. Shipped RTA (ready to assemble) in 2 cartons.

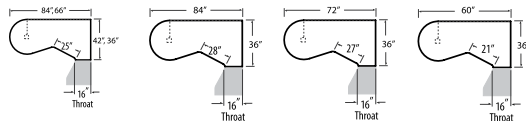

Laminate Modesty:



Glazed Modesty:

Required Specifications

- Top finish
- Top/edge detail
- Base finish
- Monopost finish

Optional Specifications

- HP laminate
- Glazing - modesty panel
- Grommet position or power block cut-out

Accessories

- Power block
- Keyboard
- Pencil drawer

EXTENDED CORNER ISLANDS (WITH RECESSED MODESTY) MODEL# DIMENSIONS FREIGHT CLASS WT/LBS. CUBIC FT. 1" TOP 1.5" TOP GLAZE ADD HP ADD

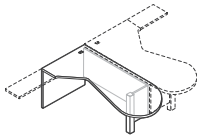

Extended Corner "P" Island - RIGHT Flush Modesty and Post

MODEL#	DIMENSIONS	FREIGHT CLASS	WT/LBS.	CUBIC FT.	1" TOP	1.5" TOP	GLAZE ADD	HP ADD
Z4284EPMR	42 x 84 x 29.5-30	70	200	10.76	\$1033	\$1271	\$608	\$762
Z3684EPMR	36 x 84 x 29.5-30	70	172	9.50	\$934	\$1146	\$608	\$572
Z3672EPMR	36 x 72 x 29.5-30	70	156	8.76	\$857	\$1036	\$554	\$430
Z3666EPMR	36 x 66 x 29.5-30	70	150	8.76	\$823	\$972	\$509	\$430
Z3660EPMR	36 x 60 x 29.5-30	70	141	6.50	\$799	\$955	\$465	\$358

Extended island worksurface on **left**. Connects to returns or bridges with a 16" throat on the right. **Not freestanding.** Grommet in worksurface. $\frac{3}{4}$ flush modesty panel is standard. Shipped RTA (ready to assemble) in 2 cartons.

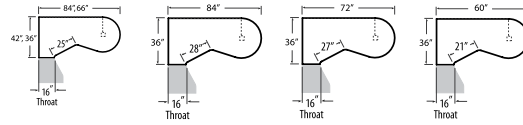

Laminate Modesty:

Glazed Modesty:

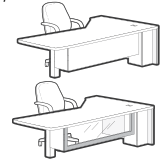

"D" ISLANDS MODEL# DIMENSIONS FREIGHT CLASS WT/LBS. CUBIC FT. 1" TOP 1.5" TOP GLAZE ADD HP ADD

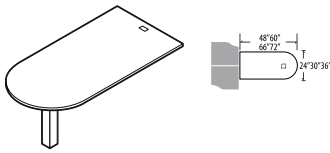

"D" Island with Monopost

Z3672I	36 x 72 x 29.5-30	70	144	8.50	\$592	\$752	N/A	\$411
Z3066I	29.7 x 66 x 29.5-30	70	115	7.50	\$552	\$678	N/A	\$385
Z3060I	29.7 x 60 x 29.5-30	70	104	6.76	\$552	\$672	N/A	\$358
Z2466I	24 x 66 x 29.5-30	85	101	7.50	\$504	\$615	N/A	\$287
Z2460I	24 x 60 x 29.5-30	85	92	6.76	\$477	\$576	N/A	\$264
Z2448I	24 x 48 x 29.5-30	85	74	5.76	\$442	\$529	N/A	\$210

Attaches to edge of worksurfaces. Attaching hardware included. Grommet in worksurface. Shipped RTA (ready to assemble).

- Post is shipped in separate carton.

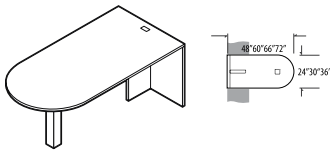

"D" Island - Full End Panel and Monopost (T-Base)

Z3672FI	36 x 72 x 29.5-30	85	123	8.50	\$727	\$887	N/A	\$411
Z3072FI	29.7 x 72 x 29.5-30	85	106	7.50	\$727	\$859	N/A	\$386
Z3066FI	29.7 x 66 x 29.5-30	85	101	7.50	\$660	\$786	N/A	\$385
Z3060FI	29.7 x 60 x 29.5-30	85	94	6.76	\$620	\$740	N/A	\$358
Z2466FI	24 x 66 x 29.5-30	85	90	7.50	\$612	\$725	N/A	\$287
Z2460FI	24 x 60 x 29.5-30	85	84	6.76	\$586	\$686	N/A	\$264
Z2448FI	24 x 48 x 29.5-30	85	74	5.76	\$552	\$638	N/A	\$210

Attaches to edge of worksurfaces. Attaching hardware included. Grommet in worksurface. **Not freestanding.** Shipped RTA (ready to assemble).

- Post is shipped in separate carton.

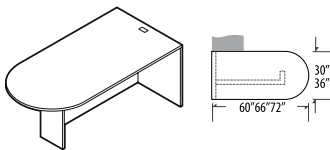

"D" Island LEFT - Full Modesty Panel (H-Base)

Z3672FIL	36 x 72 x 29.5-30	65	171	7	\$686	\$846	N/A	\$411
Z3066FIL	29.7 x 66 x 29.5-30	65	140	6	\$612	\$783	N/A	\$385
Z3060FIL	29.7 x 60 x 29.5-30	65	128	5.25	\$558	\$678	N/A	\$358

Connects to the left side of a worksurface. Attaching hardware included. Accommodates all 19" pedestals (mobile and hanging pedestals and 19.3" deep storage shells). Grommet in worksurface. Shipped RTA (ready to assemble).

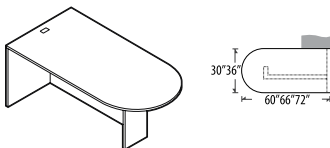

"D" Island RIGHT - Full Modesty Panel (H-Base)

Z3672FIR	36 x 72 x 29.5-30	65	171	7	\$686	\$846	N/A	\$411
Z3066FIR	29.7 x 66 x 29.5-30	65	140	6	\$612	\$783	N/A	\$385
Z3060FIR	29.7 x 60 x 29.5-30	65	128	5.25	\$558	\$678	N/A	\$358

Connects to the right side of a worksurface. Attaching hardware included. Accommodates all 19" pedestals (mobile and hanging pedestals and 19.3" deep storage shells). Grommet in worksurface. Shipped RTA (ready to assemble).

Required Specifications

- Top finish
- Top/edge detail
- Base finish
- Monopost finish

Optional Specifications

- HP laminate
- Glazing - modesty panel
- Grommet position or power block cut-out

Accessories

- Power block
- Keyboard
- Pencil drawer

"D" ISLANDS

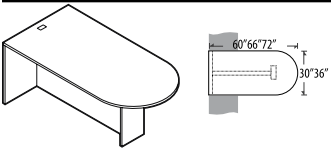

"D" Island CENTER - Full Modesty Panel (H-Base)

MODEL#	DIMENSIONS D x W x H	FREIGHT CLASS	WT./LBS.	CUBIC FT.	1" TOP	1.5" TOP	GLAZE ADD	HP ADD
Z3672FIC	36 x 72 x 29.5-30	65	171	7	\$686	\$846	N/A	\$411
Z3066FIC	29.7 x 66 x 29.5-30	65	140	6	\$612	\$783	N/A	\$385
Z3060FIC	29.7 x 60 x 29.5-30	65	123	5.25	\$558	\$678	N/A	\$358

Connects in between two worksurfaces. Attaching hardware included. **Will not accommodate pedestals.** Grommet in worksurface. Shipped RTA (ready to assemble).

"P" ISLANDS

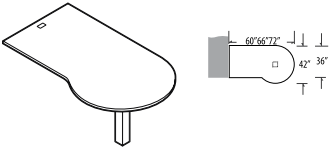

"P" Island LEFT with Post

MODEL#	DIMENSIONS	FREIGHT CLASS	WT./LBS.	CUBIC FT.	1" TOP	1.5" TOP	GLAZE ADD	HP ADD
Z3672IPL	42 x 72 x 29.5-30	85	128	9.26	\$674	\$837	N/A	\$548
Z3666IPL	42 x 66 x 29.5-30	85	119	8.76	\$674	\$800	N/A	\$548
Z3660IPL	42 x 60 x 29.5-30	85	110	8	\$612	\$738	N/A	\$467

Attaches to edge of worksurfaces. Attaching hardware included. Grommet in worksurface. Shipped RTA (ready to assemble).
 • Post is shipped in separate carton.

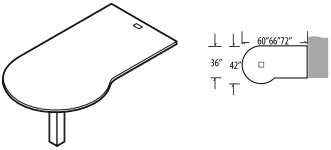

"P" Island RIGHT with Post

Z3672IPR	42 x 72 x 29.5-30	85	128	9.26	\$674	\$837	N/A	\$548
Z3666IPR	42 x 66 x 29.5-30	85	119	8.76	\$674	\$800	N/A	\$548
Z3660IPR	42 x 60 x 29.5-30	85	110	8	\$612	\$738	N/A	\$467

Attaches to edge of worksurfaces. Attaching hardware included. Grommet in worksurface. Shipped RTA (ready to assemble).
 • Post is shipped in separate carton.

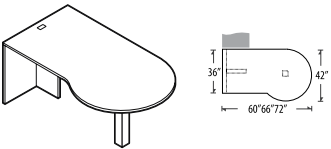

"P" Island LEFT - Full End Panel and Post (T-Base)

Z3672FPL	42 x 72 x 29.5-30	70	163	9.26	\$809	\$972	N/A	\$548
Z3666FPL	42 x 66 x 29.5-30	70	155	8.76	\$809	\$941	N/A	\$548
Z3660FPL	42 x 60 x 29.5-30	70	145	8	\$748	\$874	N/A	\$467

Connects to left side of worksurface. Attaching hardware included. **Not freestanding.** Grommet in worksurface. Shipped RTA (ready to assemble).
 • Post is shipped in separate carton.

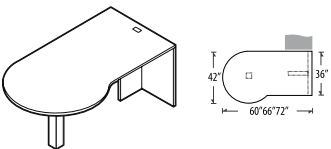

"P" Island RIGHT - Full End Panel and Post (T-Base)

Z3672FPR	42 x 72 x 29.5-30	70	163	9.26	\$809	\$972	N/A	\$548
Z3666FPR	42 x 66 x 29.5-30	70	155	8.76	\$809	\$941	N/A	\$548
Z3660FPR	42 x 60 x 29.5-30	70	145	8	\$748	\$874	N/A	\$467

Connects to right side of worksurface. Attaching hardware included. **Not freestanding.** Grommet in worksurface. Shipped RTA (ready to assemble).
 • Post is shipped in separate carton.

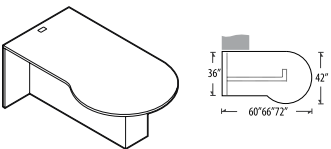

"P" Island LEFT - Full Modesty Panel (H-Base)

Z3672PL	42 x 72 x 29.5-30	65	178	7.75	\$762	\$924	N/A	\$548
Z3666PL	42 x 66 x 29.5-30	65	167	7.25	\$695	\$821	N/A	\$548
Z3660PL	42 x 60 x 29.5-30	65	155	6.50	\$639	\$766	N/A	\$467

Connects to the left side of a worksurface. Attaching hardware included. Accommodates all 19" pedestals (freestanding, mobile and hanging pedestals). Grommet in worksurface. Shipped RTA (ready to assemble).

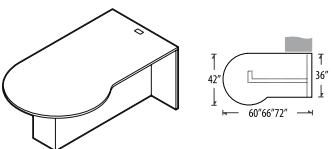

"P" Island RIGHT - Full Modesty Panel (H-Base)

Z3672PR	42 x 72 x 29.5-30	65	178	7.75	\$762	\$924	N/A	\$548
Z3666PR	42 x 66 x 29.5-30	65	167	7.25	\$695	\$821	N/A	\$548
Z3660PR	42 x 60 x 29.5-30	65	155	6.50	\$639	\$766	N/A	\$467

Connects to the left side of a worksurface. Attaching hardware included. Accommodates all 19" pedestals (freestanding, mobile and hanging pedestals). Grommet in worksurface. Shipped RTA (ready to assemble).

Required Specifications

Top finish
 Top/edge detail
 Base finish
 Monopost finish

Optional Specifications

HP laminate
 Grommet position or power block cut-out

Accessories

Power block
 Keyboard
 Pencil drawer

RECTANGULAR ISLANDS

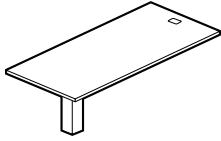

Rectangular Island w/Monopost

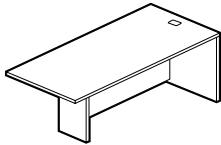

Rectangular Island LEFT - Full Modesty Panel (H-Base)

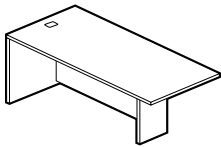

Rectangular Island RIGHT - Full Modesty Panel (H-Base)

MODEL#	DIMENSIONS	FREIGHT CLASS	WT/LBS.	CUBIC FT.	1"TOP	1.5" TOP	GLAZE ADD	HP ADD
D x W x H								
Z3672RI	36 x 72 x 29.5-30	125	90	14.50	\$586	\$745	N/A	\$468
Z3066RI	30 x 66 x 29.5-30	150	72	12.50	\$546	\$670	N/A	\$385
Z3060RI	30 x 60 x 29.5-30	125	66	10.50	\$546	\$665	N/A	\$360
Z2466RI	24 x 66 x 29.5-30	150	63	15	\$498	\$613	N/A	\$287
Z2460RI	24 x 60 x 29.5-30	150	57	13	\$473	\$572	N/A	\$266
Z2448RI	24 x 48 x 29.5-30	150	47	11.50	\$439	\$528	N/A	\$213

Attaches to edge of worksurfaces. Attaching hardware included. Grommet in worksurface. Shipped RTA (ready to assemble).

Not freestanding.

- Post is shipped in separate carton.

Z3672RFIL	36 x 72 x 29.5-30	70	145	7.25	\$679	\$838	N/A	\$468
Z3084RFIL	29.69 x 84 x 29.5-30	70	146	7.25	\$675	\$833	N/A	\$464
Z3066RFIL	29.69 x 66 x 29.5-30	70	121	6.25	\$606	\$779	N/A	\$385
Z3060RFIL	29.69 x 60 x 29.5-30	70	110	5.25	\$552	\$671	N/A	\$360
Z2472RFIL	24 x 72 x 29.5-30	70	116	6.25	\$518	\$641	N/A	\$292
Z2466RFIL	24 x 66 x 29.5-30	70	109	5.75	\$492	\$616	N/A	\$287
Z2460RFIL	24 x 60 x 29.5-30	70	99	5.25	\$468	\$567	N/A	\$266
Z2448RFIL	24 x 48 x 29.5-30	70	85	4.20	\$443	\$519	N/A	\$213

Connects to the **left** side of a worksurface. Attaching hardware included. 36" and 30"D accommodates all 19" pedestals (freestanding, mobile and hanging pedestals). Grommet in worksurface. Shipped RTA (ready to assemble). **Not freestanding.**

Z3672RFIR	36 x 72 x 29.5-30	70	145	7.25	\$679	\$838	N/A	\$468
Z3084RFIR	29.69 x 84 x 29.5-30	70	146	7.25	\$675	\$833	N/A	\$464
Z3066RFIR	29.69 x 66 x 29.5-30	70	121	6.25	\$606	\$779	N/A	\$385
Z3060RFIR	29.69 x 60 x 29.5-30	70	110	5.25	\$552	\$671	N/A	\$360
Z2472RFIR	24 x 72 x 29.5-30	70	116	6.25	\$518	\$641	N/A	\$292
Z2466RFIR	24 x 66 x 29.5-30	70	109	5.75	\$492	\$616	N/A	\$287
Z2460RFIR	24 x 60 x 29.5-30	70	99	5.25	\$468	\$567	N/A	\$266
Z2448RFIR	24 x 48 x 29.5-30	70	85	4.20	\$443	\$519	N/A	\$213

Connects to the **right** side of a worksurface. Attaching hardware included. 36" and 30"D accommodates all 19" pedestals (freestanding, mobile and hanging pedestals). Grommet in worksurface. Shipped RTA (ready to assemble). **Not freestanding.**

Required Specifications

- Top finish
- Top/edge detail
- Base finish
- Monopost finish

Optional Specifications

- HP laminate
- Grommet position or power block cut-out

Accessories

- Power block
- Keyboard
- Pencil drawer

METAL LEG ISLANDS

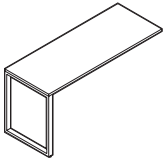

Return w/Metal Legs - LEFT

MODEL#	DIMENSIONS D x W x H	FREIGHT CLASS	WT./LBS.	CUBIC FT.	1" TOP	1.5" TOP	GLAZE ADD	HP ADD
Z3672MRL	36 x 72 x 29	100	116	11.25	\$827	\$976	N/A	\$468
Z3072MRL	30 x 72 x 29	92.5	100	10	\$758	\$887	N/A	\$385
Z3066MRL	30 x 66 x 29	70	94	9.75	\$729	\$843	N/A	\$385
Z3060MRL	30 x 60 x 29	70	88	9.25	\$694	\$804	N/A	\$358
Z2472MRL	24 x 72 x 29	70	85	8.25	\$694	\$797	N/A	\$287
Z2466MRL	24 x 66 x 29	70	80	8	\$669	\$763	N/A	\$287
Z2460MRL	24 x 60 x 29	70	75	7.75	\$640	\$730	N/A	\$264
Z2448MRL	24 x 48 x 29	70	56	5.75	\$552	\$622	N/A	\$210

Flush return attached to the edge of worksurface. Attaching hardware included. Leg shipped in separate carton. Shipped RTA (ready to assemble). **Not freestanding.**

- Please note, glides need to be extended a small amount to accommodate the 29.5" height of standard Zira pieces.

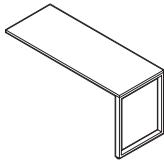

Return w/Metal Legs - RIGHT

Z3672MRR	36 x 72 x 29	100	116	11.25	\$827	\$976	N/A	\$468
Z3072MRR	30 x 72 x 29	92.5	100	10	\$758	\$887	N/A	\$385
Z3066MRR	30 x 66 x 29	70	94	9.75	\$729	\$843	N/A	\$385
Z3060MRR	30 x 60 x 29	70	88	9.25	\$694	\$804	N/A	\$358
Z2472MRR	24 x 72 x 29	70	85	8.25	\$694	\$797	N/A	\$287
Z2466MRR	24 x 66 x 29	70	80	8	\$669	\$763	N/A	\$287
Z2460MRR	24 x 60 x 29	70	75	7.75	\$640	\$730	N/A	\$264
Z2448MRR	24 x 48 x 29	70	56	5.75	\$552	\$622	N/A	\$210

Flush return attached to the edge of worksurface. Attaching hardware included. Leg shipped in separate carton. Shipped RTA (ready to assemble). **Not freestanding.**

- Please note, glides need to be extended a small amount to accommodate the 29.5" height of standard Zira pieces.

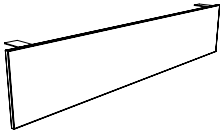

Melamine Modesty Panel

Z72LMP	.69 x 66 x 18.1	70	28	1.25	\$218	N/A	N/A	N/A
Z66LMP	.69 x 60 x 18.1	65	26	1	\$208	N/A	N/A	N/A
Z60LMP	.69 x 54 x 18.1	65	23	1	\$193	N/A	N/A	N/A
Z48LMP	.69 x 42 x 18.1	65	19	.75	\$163	N/A	N/A	N/A

For returns with metal legs. Modular laminate modesty panel. Specify model # corresponding to worksurface length.

RADIUS SPANNER ISLANDS

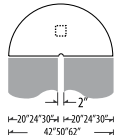
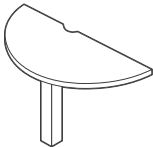

Radius Spanner Island with 2" Panel Cut-Out

MODEL#	DIMENSIONS	FREIGHT CLASS	WT./LBS.	CUBIC FT.	1" TOP	1.5" TOP	GLAZE ADD	HP ADD
Z62RS	30.57 x 62 x 29.5-30	92.5	79	6.76	\$720	\$856	N/A	\$330
Z50RS	25 x 50 x 29.5-30	92.5	60	5.76	\$620	\$722	N/A	\$274
Z42RS	25 x 42 x 29.5-30	92.5	53	5.26	\$565	\$667	N/A	\$221

Used to connect two back-to-back units of same depth with a panel. Includes monopost. Requires "L" bracket (model **MLB90**) for connection to full end panels. Shipped RTA (ready to assemble).

- Post is shipped in separate carton.
- **MLB90** must be ordered separately - see page 281.

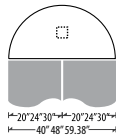
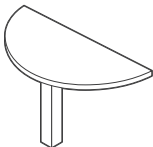

Radius Spanner Island

Z60RS	29.7 x 60 x 29.5-30	85	76	5.76	\$720	\$844	N/A	\$274
Z48RS	24 x 48 x 29.5-30	100	56	5.76	\$620	\$709	N/A	\$221
Z40RS	24 x 40 x 29.5-30	100	51	5.26	\$565	\$654	N/A	\$221

Used to connect two back-to-back units of same depth with a panel. Includes monopost. Requires "L" bracket (model **MLB90**) for connection to full end panels. Shipped RTA (ready to assemble).

- Post is shipped in separate carton.
- **MLB90** must be ordered separately - see page 281.

Required Specifications

- Top finish
- Top/edge detail
- Leg finish

UNIVERSAL TOPS	MODEL#	DIMENSIONS	FREIGHT CLASS	WT/LBS.	CUBIC FT.	1" TOP	1.5" TOP	GLAZE ADD	HP ADD
		D x W x H							
ZUT1696		16 x 96 x 1	100	42	5	\$417	\$139	N/A	\$250
ZUT1690		16 x 90 x 1	100	39	4.75	\$394	\$130	N/A	\$232
ZUT1684		16 x 84 x 1	100	37	4.50	\$357	\$120	N/A	\$218
ZUT1678		16 x 78 x 1	100	34	4.25	\$343	\$111	N/A	\$204
ZUT1672		16 x 72 x 1	85	31	2.25	\$320	\$102	N/A	\$186
ZUT1666		16 x 66 x 1	85	29	2	\$297	\$92	N/A	\$172
ZUT1660		16 x 60 x 1	85	26	1.75	\$274	\$83	N/A	\$158
ZUT1654		16 x 54 x 1	85	24	1.75	\$246	\$79	N/A	\$139
ZUT1648		16 x 48 x 1	85	21	1.50	\$223	\$69	N/A	\$125
ZUT1642		16 x 42 x 1	85	18	1.25	\$200	\$60	N/A	\$112
ZUT1636		16 x 36 x 1	85	16	1.25	\$172	\$51	N/A	\$93
ZUT1630		16 x 30 x 1	85	13	1	\$149	\$41	N/A	\$79
ZUT1896		18 x 96 x 1	100	47	5.50	\$426	\$135	N/A	\$278
ZUT1890		18 x 90 x 1	100	44	5.25	\$403	\$125	N/A	\$264
ZUT1884		18 x 84 x 1	100	41	4.75	\$375	\$121	N/A	\$246
ZUT1878		18 x 78 x 1	100	38	4.50	\$352	\$107	N/A	\$227
ZUT1872		18 x 72 x 1	70	35	2.25	\$329	\$102	N/A	\$209
ZUT1866		18 x 66 x 1	85	32	2.25	\$301	\$93	N/A	\$195
ZUT1860		18 x 60 x 1	85	29	2	\$278	\$84	N/A	\$176
ZUT1854		18 x 54 x 1	85	26	1.75	\$250	\$79	N/A	\$158
ZUT1848		18 x 48 x 1	85	23	1.75	\$232	\$69	N/A	\$139
ZUT1842		18 x 42 x 1	85	20	1.50	\$209	\$60	N/A	\$125
ZUT1836		18 x 36 x 1	85	18	1.25	\$176	\$51	N/A	\$107
ZUT1830		18 x 30 x 1	85	15	1.25	\$153	\$42	N/A	\$88
ZUT2096		20 x 96 x 1	100	52	6	\$431	\$139	N/A	\$311
ZUT2090		20 x 90 x 1	100	49	5.50	\$408	\$130	N/A	\$292
ZUT2084		20 x 84 x 1	100	45	5.25	\$380	\$120	N/A	\$274
ZUT2078		20 x 78 x 1	100	42	4.75	\$334	\$111	N/A	\$255
ZUT2072		20 x 72 x 1	70	39	2.50	\$334	\$102	N/A	\$232
ZUT2066		20 x 66 x 1	70	36	2.25	\$306	\$97	N/A	\$213
ZUT2060		20 x 60 x 1	85	32	2.25	\$283	\$83	N/A	\$195
ZUT2054		20 x 54 x 1	85	29	2	\$260	\$74	N/A	\$176
ZUT2048		20 x 48 x 1	85	26	1.75	\$237	\$64	N/A	\$158
ZUT2042		20 x 42 x 1	70	23	1.50	\$213	\$56	N/A	\$139
ZUT2036		20 x 36 x 1	85	20	1.50	\$181	\$51	N/A	\$116
ZUT2030		20 x 30 x 1	85	16	1.25	\$158	\$42	N/A	\$98
ZUT2496		24 x 96 x 1	100	62	6.75	\$496	\$162	N/A	\$371
ZUT2490		24 x 90 x 1	100	58	6.25	\$468	\$153	N/A	\$348
ZUT2484		24 x 84 x 1	100	55	6	\$436	\$143	N/A	\$325
ZUT2478		24 x 78 x 1	100	51	5.50	\$408	\$134	N/A	\$301
ZUT2472		24 x 72 x 1	100	47	5.25	\$380	\$116	N/A	\$278
ZUT2466		24 x 66 x 1	100	43	4.75	\$352	\$116	N/A	\$255
ZUT2460		24 x 60 x 1	100	39	4.50	\$325	\$101	N/A	\$232
ZUT2454		24 x 54 x 1	100	35	4	\$297	\$92	N/A	\$209
ZUT2448		24 x 48 x 1	70	31	2	\$269	\$83	N/A	\$186
ZUT2442		24 x 42 x 1	70	27	1.75	\$237	\$74	N/A	\$163
ZUT2436		24 x 36 x 1	70	23	1.50	\$209	\$65	N/A	\$139
ZUT2430		24 x 30 x 1	85	20	1.50	\$181	\$51	N/A	\$116

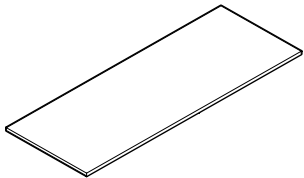

Laminate Tops

1" thick laminate tops for placement over Zira storage.

- Contact Global for pricing on special size tops.

Required Specifications

Top finish
Top/edge detail

Optional Specifications

HP laminate
Grommet position or power block cut-out

Accessories

Power block

UNIVERSAL TOPS

MODEL#	DIMENSIONS D x W x H	FREIGHT CLASS	WT/LBS.	CUBIC FT.	1" TOP	1.5" TOP	GLAZE ADD	HP ADD
ZUT3096	30 x 96 x 1	100	77	8	\$584	\$208	N/A	\$463
ZUT3090	30 x 90 x 1	100	72	7.50	\$551	\$195	N/A	\$436
ZUT3084	30 x 84 x 1	100	67	7.25	\$519	\$181	N/A	\$408
ZUT3078	30 x 78 x 1	100	62	6.75	\$482	\$167	N/A	\$380
ZUT3072	30 x 72 x 1	100	58	6.25	\$468	\$157	N/A	\$348
ZUT3066	30 x 66 x 1	100	53	5.75	\$417	\$139	N/A	\$320
ZUT3060	30 x 60 x 1	100	48	5.25	\$385	\$125	N/A	\$292
ZUT3054	30 x 54 x 1	100	43	4.75	\$352	\$111	N/A	\$264
ZUT3048	30 x 48 x 1	70	38	2.50	\$315	\$107	N/A	\$232
ZUT3042	30 x 42 x 1	70	34	2.25	\$283	\$88	N/A	\$204
ZUT3036	30 x 36 x 1	85	29	2	\$246	\$79	N/A	\$176
ZUT3030	30 x 30 x 1	85	24	1.75	\$213	\$65	N/A	\$149
ZUT3696	36 x 96 x 1	92.5	93	9.25	\$681	\$245	N/A	\$556
ZUT3690	36 x 90 x 1	100	87	8.75	\$639	\$232	N/A	\$524
ZUT3684	36 x 84 x 1	100	81	8.25	\$588	\$218	N/A	\$487
ZUT3678	36 x 78 x 1	100	76	7.75	\$561	\$199	N/A	\$454
ZUT3672	36 x 72 x 1	100	70	7.25	\$524	\$185	N/A	\$417
ZUT3666	36 x 66 x 1	100	64	6.75	\$473	\$166	N/A	\$385
ZUT3660	36 x 60 x 1	100	58	6.25	\$440	\$153	N/A	\$348
ZUT3654	36 x 54 x 1	100	52	5.50	\$408	\$134	N/A	\$315
ZUT3648	36 x 48 x 1	100	47	5	\$366	\$125	N/A	\$278
ZUT3642	36 x 42 x 1	100	41	4.50	\$329	\$107	N/A	\$246
ZUT3636	36 x 36 x 1	100	35	4	\$288	\$92	N/A	\$209
ZUT3630	36 x 30 x 1	100	29	3.50	\$246	\$79	N/A	\$176
ZUT4296	42 x 96 x 1	92.5	108	10	\$769	\$287	N/A	\$649
ZUT4290	42 x 90 x 1	92.5	102	10	\$727	\$269	N/A	\$612
ZUT4284	42 x 84 x 1	92.5	95	9.50	\$667	\$250	N/A	\$570
ZUT4278	42 x 78 x 1	92.5	88	8.75	\$639	\$232	N/A	\$528
ZUT4272	42 x 72 x 1	100	81	8.25	\$593	\$218	N/A	\$487
ZUT4266	42 x 66 x 1	92.5	75	7.50	\$551	\$195	N/A	\$450
ZUT4260	42 x 60 x 1	100	68	7	\$505	\$181	N/A	\$408
ZUT4254	42 x 54 x 1	100	61	6.25	\$459	\$162	N/A	\$366
ZUT4248	42 x 48 x 1	100	54	5.75	\$417	\$144	N/A	\$325
ZUT4242	42 x 42 x 1	100	48	5.25	\$371	\$125	N/A	\$288
ZUT4236	42 x 36 x 1	100	41	4.50	\$315	\$139	N/A	\$246
ZUT4230	42 x 30 x 1	100	34	4	\$255	\$93	N/A	\$204
ZUT4896	48 x 96 x 1	92.5	124	11.25	\$866	\$329	N/A	\$741
ZUT4890	48 x 90 x 1	92.5	116	10.50	\$820	\$305	N/A	\$695
ZUT4884	48 x 84 x 1	92.5	108	10.50	\$764	\$287	N/A	\$649
ZUT4878	48 x 78 x 1	92.5	101	10	\$713	\$264	N/A	\$602
ZUT4872	48 x 72 x 1	92.5	93	9.25	\$667	\$246	N/A	\$556
ZUT4866	48 x 66 x 1	92.5	85	8.50	\$616	\$227	N/A	\$510
ZUT4860	48 x 60 x 1	92.5	77	7.25	\$570	\$204	N/A	\$463
ZUT4854	48 x 54 x 1	100	70	7.25	\$519	\$185	N/A	\$417
ZUT4848	48 x 48 x 1	100	62	6.50	\$463	\$167	N/A	\$371
ZUT4842	48 x 42 x 1	100	54	5.75	\$417	\$144	N/A	\$325
ZUT4836	48 x 36 x 1	100	47	5	\$366	\$121	N/A	\$278
ZUT4830	48 x 30 x 1	100	36	4.25	\$311	\$102	N/A	\$232

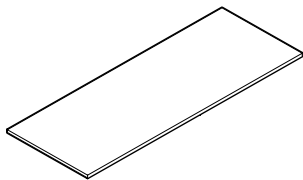

Laminate Tops

1" thick laminate tops for placement over Zira storage.

- Contact Global for pricing on special size tops.

Required Specifications

Top finish
Top/edge detail

Optional Specifications

HP laminate
Grommet position or power block cut-out

Accessories

Power block

UNIVERSAL TOPS

MODEL#	DIMENSIONS D x W x H	FREIGHT CLASS	WT/LBS.	CUBIC FT.	1" TOP	1.5" TOP	GLAZE ADD	HP ADD
ZUT5496	54 x 96 x 1	92.5	139	12.50	\$963	\$366	N/A	\$834
ZUT5490	54 x 90 x 1	92.5	131	11.75	\$908	\$347	N/A	\$783
ZUT5484	54 x 84 x 1	92.5	122	11	\$857	\$324	N/A	\$732
ZUT5478	54 x 78 x 1	92.5	113	10.25	\$806	\$296	N/A	\$681
ZUT5472	54 x 72 x 1	92.5	105	9.50	\$750	\$278	N/A	\$625
ZUT5466	54 x 66 x 1	92.5	96	9.50	\$700	\$250	N/A	\$575
ZUT5460	54 x 60 x 1	100	87	8.75	\$644	\$231	N/A	\$524
ZUT5454	54 x 54 x 1	100	78	8	\$575	\$208	N/A	\$473
ZUT5448	54 x 48 x 1	100	70	7.25	\$519	\$185	N/A	\$417
ZUT5442	54 x 42 x 1	100	61	6.25	\$459	\$162	N/A	\$366
ZUT5436	54 x 36 x 1	100	52	5.50	\$352	\$134	N/A	\$315
ZUT5430	54 x 30 x 1	100	44	4.75	\$352	\$116	N/A	\$264
ZUT6096	60 x 96 x 1	92.5	155	14	\$1061	\$407	N/A	\$926
ZUT6090	60 x 90 x 1	92.5	145	13	\$1000	\$385	N/A	\$871
ZUT6084	60 x 84 x 1	92.5	135	12.25	\$940	\$361	N/A	\$811
ZUT6078	60 x 78 x 1	92.5	126	11.50	\$885	\$333	N/A	\$755
ZUT6072	60 x 72 x 1	92.5	116	10.50	\$811	\$305	N/A	\$695
ZUT6066	60 x 66 x 1	92.5	106	9.75	\$750	\$283	N/A	\$639
ZUT6060	60 x 60 x 1	92.5	97	8.75	\$695	\$255	N/A	\$579
ZUT6054	60 x 54 x 1	100	87	8.75	\$644	\$231	N/A	\$524
ZUT6048	60 x 48 x 1	100	77	7.75	\$570	\$204	N/A	\$463
ZUT6042	60 x 42 x 1	100	68	7	\$505	\$181	N/A	\$408
ZUT6036	60 x 36 x 1	100	58	6.25	\$463	\$153	N/A	\$348
ZUT6030	60 x 30 x 1	100	49	5.25	\$385	\$125	N/A	\$292

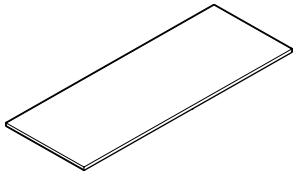

Laminate Tops

1" thick laminate tops for placement over Zira storage.

- Contact Global for pricing on special size tops.

Required Specifications

Top finish
Top/edge detail

Optional Specifications

HP laminate
Grommet position or power block cut-out

Accessories

Power block

FILE TOPS

MODEL#	DIMENSIONS D x W x H	FREIGHT CLASS	WT/LBS.	CUBIC FT.	1" TOP	1.5" TOP	GLAZE ADD	HP ADD
ZUFT1896	18.11 x 96.10 x 1	100	47	5.50	\$426	\$561	N/A	\$283
ZUFT1890	18.11 x 90.12 x 1	100	44	5.25	\$403	\$528	N/A	\$264
ZUFT1884	18.11 x 84.09 x 1	100	41	4.75	\$375	\$496	N/A	\$246
ZUFT1878	18.11 x 78.11 x 1	100	38	4.50	\$352	\$459	N/A	\$232
ZUFT1872	18.11 x 72.13 x 1	70	35	2.25	\$329	\$431	N/A	\$213
ZUFT1866	18.11 x 66.10 x 1	85	32	2.25	\$301	\$394	N/A	\$195
ZUFT1860	18.11 x 60.12 x 1	85	29	2	\$278	\$362	N/A	\$176
ZUFT1854	18.11 x 54.09 x 1	70	27	1.75	\$250	\$329	N/A	\$163
ZUFT1848	18.11 x 48.11 x 1	85	24	1.75	\$223	\$297	N/A	\$144
ZUFT1842	18.11 x 42.13 x 1	85	21	1.50	\$200	\$264	N/A	\$125
ZUFT1836	18.11 x 36.10 x 1	85	18	1.25	\$176	\$218	N/A	\$107
ZUFT1830	18.11 x 30.12 x 1	85	15	1.25	\$153	\$195	N/A	\$88
ZUFT1996	19.25 x 96.10 x 1	100	50	5.75	\$431	\$570	N/A	\$301
ZUFT1990	19.25 x 90.12 x 1	100	47	5.50	\$408	\$538	N/A	\$283
ZUFT1984	19.25 x 84.09 x 1	100	44	5	\$380	\$500	N/A	\$264
ZUFT1978	19.25 x 78.11 x 1	100	41	4.75	\$357	\$468	N/A	\$246
ZUFT1972	19.25 x 72.13 x 1	70	38	2.50	\$334	\$436	N/A	\$227
ZUFT1966	19.25 x 66.10 x 1	70	34	2.25	\$306	\$399	N/A	\$209
ZUFT1960	19.25 x 60.12 x 1	70	31	2	\$283	\$366	N/A	\$190
ZUFT1954	19.25 x 54.09 x 1	85	27	2	\$260	\$334	N/A	\$172
ZUFT1948	19.25 x 48.11 x 1	85	25	1.75	\$232	\$301	N/A	\$153
ZUFT1942	19.25 x 42.13 x 1	85	22	1.50	\$209	\$269	N/A	\$135
ZUFT1936	19.25 x 36.10 x 1	70	19	1.25	\$181	\$232	N/A	\$116
ZUFT1930	19.25 x 30.12 x 1	85	16	1.25	\$158	\$200	N/A	\$98

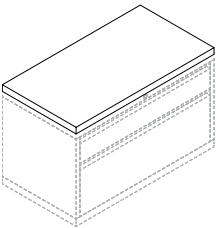

Lateral File Tops

1" thick laminate tops for placement over 1900 Series Lateral Files + Storage.

- Contact Global for pricing on special size tops.

ZUFT3696	36.14 x 96.10 x 1	100	93	9.50	\$681	\$926	N/A	\$561
ZUFT3690	36.14 x 90.12 x 1	92.5	88	8.75	\$639	\$871	N/A	\$528
ZUFT3684	36.14 x 84.09 x 1	92.5	82	7.75	\$588	\$806	N/A	\$491
ZUFT3678	36.14 x 78.11 x 1	100	76	7.75	\$561	\$760	N/A	\$459
ZUFT3672	36.14 x 72.13 x 1	100	70	7.25	\$524	\$689	N/A	\$422
ZUFT3666	36.14 x 66.10 x 1	100	64	6.75	\$473	\$639	N/A	\$385
ZUFT3660	36.14 x 60.12 x 1	100	59	6.25	\$440	\$593	N/A	\$352
ZUFT3654	36.14 x 54.09 x 1	100	53	5.50	\$408	\$542	N/A	\$315
ZUFT3648	36.14 x 48.11 x 1	100	47	5	\$366	\$491	N/A	\$283
ZUFT3642	36.14 x 42.13 x 1	100	41	4.50	\$329	\$436	N/A	\$246
ZUFT3636	36.14 x 36.10 x 1	70	35	2.25	\$288	\$380	N/A	\$213
ZUFT3630	36.14 x 30.12 x 1	85	29	2	\$250	\$325	N/A	\$176
ZUFT3896	38.62 x 96.10 x 1	92.5	100	10	\$760	\$1047	N/A	\$598
ZUFT3890	38.62 x 90.12 x 1	100	94	9.50	\$713	\$982	N/A	\$561
ZUFT3884	38.62 x 84.09 x 1	100	87	8.75	\$672	\$922	N/A	\$524
ZUFT3878	38.62 x 78.11 x 1	100	81	8.25	\$625	\$862	N/A	\$487
ZUFT3872	38.62 x 72.13 x 1	100	75	7.75	\$584	\$797	N/A	\$450
ZUFT3866	38.62 x 66.10 x 1	100	69	7	\$538	\$737	N/A	\$413
ZUFT3860	38.62 x 60.12 x 1	100	62	6.50	\$496	\$676	N/A	\$375
ZUFT3854	38.62 x 54.09 x 1	100	56	6	\$454	\$612	N/A	\$338
ZUFT3848	38.62 x 48.11 x 1	100	50	5.25	\$408	\$551	N/A	\$301
ZUFT3842	38.62 x 42.13 x 1	100	44	4.75	\$362	\$491	N/A	\$264
ZUFT3836	38.62 x 36.10 x 1	100	38	4.25	\$320	\$426	N/A	\$227
ZUFT3830	38.62 x 30.12 x 1	100	31	3.75	\$274	\$366	N/A	\$190

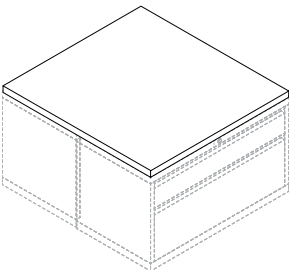

Lateral File Tops - Back to Back

1" thick laminate tops for placement over back-to-back metal filing + storage.

- Use ZUFT36xx models for 18"D laterals back-to-back
- Use ZUFT38xx models for 19.25"D laterals back-to-back
- Contact Global for pricing on special size tops.

Required Specifications

Top finish
Top/edge detail

Optional Specifications

HP laminate
Grommet position or power block cut-out

Accessories

Power block

PEDESTALS



Mobile Pedestal with Overhang*



Mobile Pedestal*



Mobile Pedestal with Overhang*

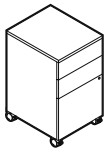

Mobile Pedestal*

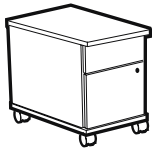

Mobile Pedestal with Overhang*

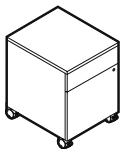

Mobile Pedestal*

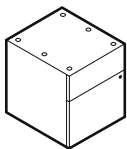

Hanging Pedestal

MODEL#	DIMENSIONS D x W x H	FREIGHT CLASS	WT/LBS.	CUBIC FT.	1" TOP	1.5" TOP	GLAZE ADD	HP ADD
ZMPFF28	29 x 16 x 27.5-28	92.5	106	10.25	\$966	N/A	N/A	\$166
ZMPFF22	23 x 16 x 27.5-28	92.5	95	8.25	\$918	N/A	N/A	\$166

File/File drawers on fully progressive ball bearing slides, accommodate letter and legal size hanging files. Pedestal top features 1" overhang with built-in grip for ease of mobility. Includes counterweight to prevent tipping. Drawers are locking. Only front casters are locking.

ZMPFF19	19 x 16 x 27.5-28	85	97	7.25	\$868	N/A	N/A	\$166
---------	-------------------	----	----	------	--------------	-----	-----	--------------

File/File drawers on fully progressive ball bearing slides, accommodate letter and legal size hanging files. Drawers are locking. Only front casters are locking.

ZMPBBF28	29 x 16 x 27.5-28	92.5	105	10.25	\$886	N/A	N/A	\$166
ZMPBBF22	23 x 16 x 27.5-28	92.5	92	8.25	\$853	N/A	N/A	\$164

Box/Box/File drawers on fully progressive ball bearing slides, accommodate letter and legal size hanging files. Pedestal top features 1" overhang with built-in grip for ease of mobility. Includes counterweight to prevent tipping. File drawer and lower box drawer are locking. Only front casters are locking.

ZMPBBF19	19 x 16 x 27.5-28	85	96	7.25	\$808	N/A	N/A	\$166
----------	-------------------	----	----	------	--------------	-----	-----	--------------

Box/Box/File drawers on fully progressive ball bearing slides, accommodate letter and legal size hanging files. File drawer and lower box drawer are locking. Only front casters are locking.

ZMPBF28	29 x 16 x 21.5-22	92.5	83	8.25	\$778	N/A	N/A	\$166
ZMPBF22	23 x 16 x 21.5-22	92.5	73	6.75	\$759	N/A	N/A	\$166

Box/File drawers on fully progressive ball bearing slides, accommodate letter and legal size hanging files. Pedestal top features 1" overhang with built-in grip for ease of mobility. Includes counterweight to prevent tipping. Drawers are locking. Only front casters are locking.

ZMPBF19	19 x 16 x 21.5-22	85	77	6.25	\$712	N/A	N/A	\$166
---------	-------------------	----	----	------	--------------	-----	-----	--------------

Box/File drawers on fully progressive ball bearing slides, accommodate letter and legal size hanging files. Drawers are locking. Only front casters are locking.

ZHPBF18	19 x 16 x 17.5-18	92.5	48	4.50	\$530	N/A	N/A	N/A
---------	-------------------	------	----	------	--------------	-----	-----	-----

Box/File drawers on fully progressive ball bearing slides, accommodate letter and legal size hanging files. Drawers are locking.

Required Specifications

Top finish
Top/edge detail
Base finish
Lock finish

Optional Specifications

HP laminate*
Handles

STORAGE SHELLS - 16.87" HIGH

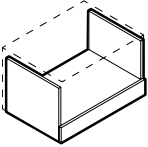

Open Storage Shell

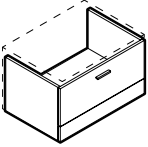

Lateral File Shell

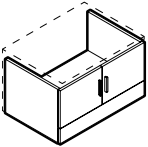

Glazed door option

Closed Storage Shell**

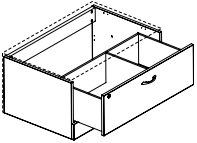

Split Drawer Storage Shell* - LEFT

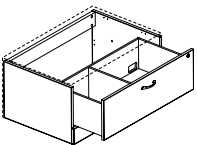

Split Drawer Storage Shell* - RIGHT

MODEL#	DIMENSIONS D x W x H	FREIGHT CLASS	WT/LBS.	CUBIC FT.	1" TOP	1.5" TOP	GLAZE ADD	HP ADD
Z36L21SNS	24 x 36 x 16.87	150	62	11.25	\$479	N/A	N/A	N/A
Z30L21SNS	24 x 30 x 16.87	150	55	9.50	\$430	N/A	N/A	N/A
Z36M21SNS	20 x 36 x 16.87	150	56	9.50	\$442	N/A	N/A	N/A
Z30M21SNS	20 x 30 x 16.87	125	49	8	\$395	N/A	N/A	N/A

For use under Zxxxx1TB 17.37" H top and back kit. **No top or back.**

Z36L21ES	24 x 36 x 16.87	125	82	11.25	\$702	N/A	N/A	N/A
Z30L21ES	24 x 30 x 16.87	100	77	9.50	\$613	N/A	N/A	N/A
Z36M21ES	20 x 36 x 16.87	100	78	9.50	\$676	N/A	N/A	N/A
Z30M21ES	20 x 30 x 16.87	100	73	8	\$586	N/A	N/A	N/A

For use under Zxxxx1TB 17.37" H top and back kit. **No top or back.** 36" and 30" wide models have front-to-back and side-to-side letter/legal filing capability. Side-to-side file bars included.

- Lateral file drawer construction is for accommodating hanging files NOT for stacking materials on the drawer bottom.

Z36L21SHS	24 x 36 x 16.87	125	71	11.25	\$638	N/A	\$304	N/A
Z30L21SHS	24 x 30 x 16.87	125	62	9.50	\$576	N/A	\$272	N/A
Z36M21SHS	20 x 36 x 16.87	125	65	9.50	\$601	N/A	\$304	N/A
Z30M21SHS	20 x 30 x 16.87	125	57	8	\$542	N/A	\$271	N/A

For use under Zxxxx1TB 17.37" H top and back kit. **No top or back.** Laminate doors are standard. Standard with lock.

Z36L21XSL	24 x 36 x 16.87	125	81	11.25	\$650	N/A	N/A	N/A
Z30L21XSL	24 x 30 x 16.87	125	72	9.50	\$593	N/A	N/A	N/A
Z36M21XSL	20 x 36 x 16.87	100	78	9.50	\$624	N/A	N/A	N/A
Z30M21XSL	20 x 30 x 16.87	100	69	8	\$568	N/A	N/A	N/A

For use under Zxxxx1TB 17.37" H top and back kit. **No top or back.** Pull out drawer includes filing space on **left** and storage on **right**. Front-to-back letter capability.

- Lateral file drawer construction is for accommodating hanging files NOT for stacking materials on the drawer bottom.

Z36L21XSR	24 x 36 x 16.87	125	81	11.25	\$650	N/A	N/A	N/A
Z30L21XSR	24 x 30 x 16.87	125	72	9.50	\$593	N/A	N/A	N/A
Z36M21XSR	20 x 36 x 16.87	100	78	9.50	\$624	N/A	N/A	N/A
Z30M21XSR	20 x 30 x 16.87	100	69	8	\$568	N/A	N/A	N/A

For use under Zxxxx1TB 17.37" H top and back kit. **No top or back.** Pull out drawer includes filing space on **right** and storage on **left**. Front-to-back letter capability.

- Lateral file drawer construction is for accommodating hanging files NOT for stacking materials on the drawer bottom.

Required Specifications

Base finish
Handles*

Optional Specifications

Key #*
Glazed doors**

TOP AND BACK KITS FOR 16.87" H SHELLS

MODEL#	DIMENSIONS D x W x H	FREIGHT CLASS	WT/LBS.	CUBIC FT.	1" TOP	1.5" TOP	GLAZE ADD	HP ADD
Z24961TB	24 x 96 x 17.37-17.87	70	104	6.75	\$602	\$733	N/A	\$389
Z24901TB	24 x 90 x 17.37-17.87	70	97	6.25	\$572	\$695	N/A	\$365
Z24841TB	24 x 84 x 17.37-17.87	70	91	6	\$538	\$653	N/A	\$341
Z24781TB	24 x 78 x 17.37-17.87	70	86	5.50	\$504	\$609	N/A	\$316
Z24721TB	24 x 72 x 17.37-17.87	85	78	5.25	\$468	\$567	N/A	\$292
Z24661TB	24 x 66 x 17.37-17.87	70	72	4.75	\$433	\$524	N/A	\$268
Z24601TB	24 x 60 x 17.37-17.87	85	66	4.50	\$397	\$479	N/A	\$244
Z24541TB	24 x 54 x 17.37-17.87	85	59	4	\$359	\$433	N/A	\$219
Z24481TB	24 x 48 x 17.37-17.87	85	55	3.75	\$330	\$396	N/A	\$195
Z24421TB	24 x 42 x 17.37-17.87	85	47	3.25	\$292	\$350	N/A	\$171
Z24361TB	24 x 36 x 17.37-17.87	85	40	3	\$253	\$303	N/A	\$146
Z24301TB	24 x 30 x 17.37-17.87	85	34	2.50	\$218	\$259	N/A	\$122
Z20961TB	20 x 96 x 17.37-17.87	70	93	6	\$555	\$664	N/A	\$325
Z20901TB	20 x 90 x 17.37-17.87	70	86	5.50	\$520	\$622	N/A	\$304
Z20841TB	20 x 84 x 17.37-17.87	70	76	4.75	\$462	\$558	N/A	\$284
Z20781TB	20 x 78 x 17.37-17.87	70	80	5.25	\$489	\$578	N/A	\$264
Z20721TB	20 x 72 x 17.37-17.87	70	69	4.50	\$427	\$509	N/A	\$244
Z20661TB	20 x 66 x 17.37-17.87	70	64	4.25	\$395	\$470	N/A	\$223
Z20601TB	20 x 60 x 17.37-17.87	70	58	3.75	\$363	\$432	N/A	\$203
Z20541TB	20 x 54 x 17.37-17.87	70	53	3.50	\$331	\$393	N/A	\$183
Z20481TB	20 x 48 x 17.37-17.87	70	50	3.25	\$304	\$359	N/A	\$163
Z20421TB	20 x 42 x 17.37-17.87	70	42	2.75	\$268	\$316	N/A	\$142
Z20361TB	20 x 36 x 17.37-17.87	85	35	2.50	\$231	\$272	N/A	\$122
Z20301TB	20 x 30 x 17.37-17.87	85	28	2.25	\$199	\$233	N/A	\$102

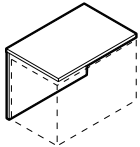

Credenza Top and Back Kit

For use with 16.87" high storage shells. Shipped RTA (ready to assemble).

Required Specifications

- Top finish
- Top/edge detail
- Base finish

Optional Specifications

- HP laminate

STORAGE SHELLS - 22.75" HIGH

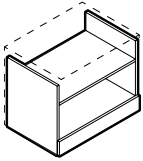

1.5H Open Storage Shell

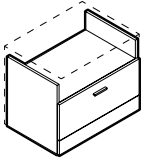

1.5H Open/Lateral File Shell*

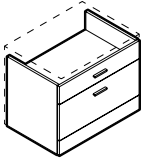

1.5H Box/Lateral File Shell*

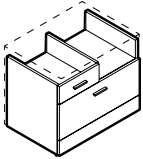

1.5H Mixed Storage Shell - LEFT*

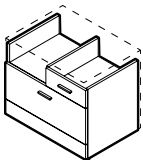

1.5H Mixed Storage Shell - RIGHT*

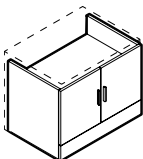

Glazed door option

1.5H Closed Storage Shell**

MODEL#	DIMENSIONS D x W x H	FREIGHT CLASS	WT/LBS.	CUBIC FT.	1" TOP	1.5" TOP	GLAZE ADD	HP ADD
Z36L2HSHNS	24 x 36 x 22.75	150	83	14.50	\$594	N/A	N/A	N/A
Z30L2HSHNS	24 x 30 x 22.75	125	75	12.25	\$537	N/A	N/A	N/A
Z24L2HSHNS	24 x 24 x 22.75	125	66	10	\$476	N/A	N/A	N/A
Z36M2HSHNS	20 x 36 x 22.75	150	73	12.25	\$542	N/A	N/A	N/A
Z30M2HSHNS	20 x 30 x 22.75	125	64	10.50	\$484	N/A	N/A	N/A
Z24M2HSHNS	20 x 24 x 22.75	125	55	8.50	\$432	N/A	N/A	N/A

For use **under ZxxxxHTB 23.25" H** top and back kit. **No top or back.**

Z36L2HFS	24 x 36 x 22.75	125	102	14.50	\$817	N/A	N/A	N/A
Z30L2HFS	24 x 30 x 22.75	125	97	12.25	\$719	N/A	N/A	N/A
Z36M2HFS	20 x 36 x 22.75	125	95	12.25	\$777	N/A	N/A	N/A
Z30M2HFS	20 x 30 x 22.75	100	88	10.50	\$675	N/A	N/A	N/A

For use **under ZxxxxHTB 23.25" H** top and back kit. **No top or back.** Open shelf and lateral file storage. 36" and 30" wide models have front-to-back and side-to-side letter/legal filing capability. Side-to-side file bars included.

- Lateral file drawer construction is for accommodating hanging files NOT for stacking materials on the drawer bottom

Z36L2HES	24 x 36 x 22.75	125	103	14.50	\$859	N/A	N/A	N/A
Z30L2HES	24 x 30 x 22.75	100	99	12.25	\$762	N/A	N/A	N/A
Z36M2HES	20 x 36 x 22.75	100	98	12.25	\$831	N/A	N/A	N/A
Z30M2HES	20 x 30 x 22.75	100	92	10.50	\$728	N/A	N/A	N/A

For use **under ZxxxxHTB 23.25" H** top and back kit. **No top or back.** Box drawer and lateral file storage. 36" and 30" wide models have front-to-back and side-to-side letter/legal filing capability. Side-to-side file bars included.

- Lateral file drawer construction is for accommodating hanging files NOT for stacking materials on the drawer bottom

Z36L2HXSL	24 x 36 x 22.75	125	110	14.50	\$926	N/A	N/A	N/A
Z30L2HXSL	24 x 30 x 22.75	100	105	12.25	\$830	N/A	N/A	N/A
Z36M2HXSL	20 x 36 x 22.75	100	104	12.25	\$874	N/A	N/A	N/A
Z30M2HXSL	20 x 30 x 22.75	100	97	10.50	\$774	N/A	N/A	N/A

For use **under ZxxxxHTB 23.25" H** top and back kit. **No top or back.** Open shelf on **right**, box drawer on **left** and lateral file storage below. 36" and 30" wide models have front-to-back and side-to-side letter/legal filing capability. Side-to-side file bars included.

- Lateral file drawer construction is for accommodating hanging files NOT for stacking materials on the drawer bottom

Z36L2HXSR	24 x 36 x 22.75	125	110	14.50	\$926	N/A	N/A	N/A
Z30L2HXSR	24 x 30 x 22.75	100	105	12.25	\$830	N/A	N/A	N/A
Z36M2HXSR	20 x 36 x 22.75	100	104	12.25	\$874	N/A	N/A	N/A
Z30M2HXSR	20 x 30 x 22.75	100	97	10.50	\$774	N/A	N/A	N/A

For use **under ZxxxxHTB 23.25" H** top and back kit. **No top or back.** Open shelf on **left**, box drawer on **right** and lateral file storage below. 36" and 30" wide models have front-to-back and side-to-side letter/legal filing capability. Side-to-side file bars included.

- Lateral file drawer construction is for accommodating hanging files NOT for stacking materials on the drawer bottom

Z36L2HSHS	24 x 36 x 22.75	125	96	14.50	\$784	N/A	\$379	N/A
Z30L2HSHS	24 x 30 x 22.75	125	86	12.25	\$709	N/A	\$336	N/A
Z36M2HSHS	20 x 36 x 22.75	125	86	12.25	\$732	N/A	\$379	N/A
Z30M2HSHS	20 x 30 x 22.75	125	75	10.50	\$655	N/A	\$336	N/A

For use **under ZxxxxHTB 23.25" H** top and back kit. **No top or back.** Laminate doors are standard. Standard with lock.

Required Specifications

Base finish
Handles*

Optional Specifications

Key #*
Glazed doors**

STORAGE SHELLS - 22.75" HIGH

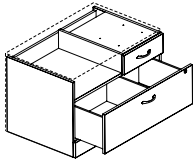

1.5H Split Drawer Storage Shell* - LEFT

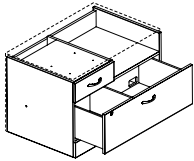

1.5H Split Drawer Storage Shell* - RIGHT

MODEL#	DIMENSIONS	FREIGHT CLASS	WT/LBS.	CUBIC FT.	1" TOP	1.5" TOP	GLAZE ADD	HP ADD
D x W x H								
Z36L2HCSL	24 x 36 x 22.75	125	110	14.50	\$882	N/A	N/A	N/A
Z30L2HCSL	24 x 30 x 22.75	100	101	12.25	\$822	N/A	N/A	N/A
Z36M2HCSL	20 x 36 x 22.75	100	104	12.25	\$830	N/A	N/A	N/A
Z30M2HCSL	20 x 30 x 22.75	100	92	10.50	\$765	N/A	N/A	N/A

For use **under ZxxxxHTB 23.25" H** top and back kit. **No top or back.** Open shelf on **right**, box drawer on **left**. Pull out drawer includes filing space on **left** and storage on **right**. Front-to-back letter capability.

- Lateral file drawer construction is for accommodating hanging files **NOT** for stacking materials on the drawer bottom.

Z36L2HCSR	24 x 36 x 22.75	125	110	14.50	\$882	N/A	N/A	N/A
Z30L2HCSR	24 x 30 x 22.75	100	101	12.25	\$822	N/A	N/A	N/A
Z36M2HCSR	20 x 36 x 22.75	100	104	12.25	\$830	N/A	N/A	N/A
Z30M2HCSR	20 x 30 x 22.75	100	92	10.50	\$765	N/A	N/A	N/A

For use **under ZxxxxHTB 23.25" H** top and back kit. **No top or back.** Open shelf on **left**, box drawer on **right**. Pull out drawer includes filing space on **right** and storage on **left**. Front-to-back letter capability.

- Lateral file drawer construction is for accommodating hanging files **NOT** for stacking materials on the drawer bottom.

TOP AND BACK KITS FOR 22.75" H SHELLS

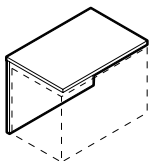

Credenza Top and Back Kit**

MODEL#	DIMENSIONS	FREIGHT CLASS	WT/LBS.	CUBIC FT.	1" TOP	1.5" TOP	GLAZE ADD	HP ADD
Z2496HTB	24 x 96 x 23.25-23.75	70	114	6.75	\$637	\$768	N/A	\$389
Z2490HTB	24 x 90 x 23.25-23.75	70	107	6.25	\$605	\$728	N/A	\$365
Z2484HTB	24 x 84 x 23.25-23.75	70	100	6	\$568	\$683	N/A	\$341
Z2478HTB	24 x 78 x 23.25-23.75	70	94	5.50	\$532	\$639	N/A	\$316
Z2472HTB	24 x 72 x 23.25-23.75	70	87	5.25	\$494	\$593	N/A	\$292
Z2466HTB	24 x 66 x 23.25-23.75	70	80	4.75	\$457	\$548	N/A	\$268
Z2460HTB	24 x 66 x 23.25-23.75	70	72	4.50	\$420	\$502	N/A	\$244
Z2454HTB	24 x 54 x 23.25-23.75	70	65	4	\$380	\$454	N/A	\$219
Z2448HTB	24 x 48 x 23.25-23.75	85	55	3.75	\$346	\$412	N/A	\$195
Z2442HTB	24 x 42 x 23.25-23.75	70	51	3.25	\$308	\$366	N/A	\$171
Z2436HTB	24 x 36 x 23.25-23.75	85	44	3	\$267	\$317	N/A	\$146
Z2430HTB	24 x 30 x 23.25-23.75	85	37	2.50	\$231	\$272	N/A	\$122
Z2096HTB	20 x 96 x 23.25-23.75	70	103	6.25	\$596	\$705	N/A	\$325
Z2090HTB	20 x 90 x 23.25-23.75	70	97	6	\$563	\$665	N/A	\$304
Z2084HTB	20 x 84 x 23.25-23.75	70	91	5.75	\$529	\$625	N/A	\$284
Z2078HTB	20 x 78 x 23.25-23.75	70	86	5.25	\$495	\$584	N/A	\$264
Z2072HTB	20 x 72 x 23.25-23.75	70	78	5	\$462	\$544	N/A	\$244
Z2066HTB	20 x 66 x 23.25-23.75	70	71	4.50	\$423	\$498	N/A	\$223
Z2060HTB	20 x 66 x 23.25-23.75	70	65	4.25	\$389	\$457	N/A	\$203
Z2054HTB	20 x 54 x 23.25-23.75	70	59	3.75	\$355	\$417	N/A	\$183
Z2048HTB	20 x 48 x 23.25-23.75	70	55	3.50	\$325	\$380	N/A	\$163
Z2042HTB	20 x 42 x 23.25-23.75	70	47	3	\$287	\$335	N/A	\$142
Z2036HTB	20 x 36 x 23.25-23.75	85	40	2.75	\$247	\$288	N/A	\$122
Z2030HTB	20 x 30 x 23.25-23.75	85	33	2.25	\$214	\$248	N/A	\$102

For use with 22.75" high storage shells. Shipped RTA (ready to assemble).

Required Specifications

- Top finish**
- Top/edge detail**
- Base finish
- Handles*

Optional Specifications

- HP laminate**

STORAGE SHELLS - 28" HIGH

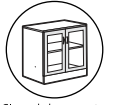
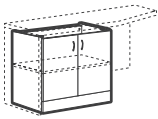

Glazed door option

Storage Shell*

MODEL#	DIMENSIONS D x W x H	FREIGHT CLASS	WT/LBS.	CUBIC FT.	1" TOP	1.5" TOP	GLAZE ADD	HP ADD
Z36L2SHS	23.4 x 36 x 28-28.5	150	100	18.50	\$734	N/A	\$572	N/A
Z30L2SHS	23.4 x 30 x 28-28.5	150	88	15.50	\$655	N/A	\$525	N/A
Z36M2SHS	19.3 x 36 x 28-28.5	150	89	15.50	\$643	N/A	\$572	N/A
Z30M2SHS	19.3 x 30 x 28-28.5	150	78	13.25	\$583	N/A	\$525	N/A

For use **under 29" H** returns, extended corners, freestanding and connectable tables of the same depth. **No top or back. One adjustable shelf.** Standard with lock.

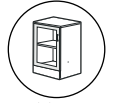
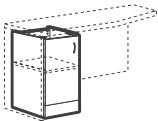

Glazed door option

Storage Shell - LEFT*

Z21L2SHSL	23.4 x 21 x 28-28.5	125	70	11	\$506	N/A	\$324	N/A
Z18L2SHSL	23.4 x 18 x 28-28.5	125	64	9.75	\$485	N/A	\$295	N/A
Z16L2SHSL	23.4 x 16 x 28-28.5	125	60	9	\$455	N/A	\$289	N/A
Z15L2SHSL	23.4 x 15 x 28-28.5	125	59	8.25	\$440	N/A	\$260	N/A
Z12L2SHSL	23.4 x 12 x 28-28.5	125	53	6.75	\$411	N/A	\$235	N/A
Z21M2SHSL	19.3 x 21 x 28-28.5	125	61	9.50	\$433	N/A	\$324	N/A
Z18M2SHSL	19.3 x 18 x 28-28.5	125	56	8.25	\$414	N/A	\$295	N/A
Z16M2SHSL	19.3 x 16 x 28-28.5	125	52	7	\$392	N/A	\$289	N/A
Z15M2SHSL	19.3 x 15 x 28-28.5	125	52	6.75	\$371	N/A	\$260	N/A
Z12M2SHSL	19.3 x 12 x 28-28.5	100	47	5.75	\$348	N/A	\$235	N/A

For use **under 29" H** returns, extended corners, freestanding and connectable tables of the same depth. **No top or back. One adjustable shelf.** Standard with lock.

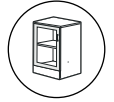
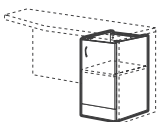

Glazed door option

Storage Shell - RIGHT*

Z21L2SHSR	23.4 x 21 x 28-28.5	125	70	11	\$506	N/A	\$324	N/A
Z18L2SHSR	23.4 x 18 x 28-28.5	125	64	9.75	\$485	N/A	\$295	N/A
Z16L2SHSR	23.4 x 16 x 28-28.5	125	60	9	\$455	N/A	\$289	N/A
Z15L2SHSR	23.4 x 15 x 28-28.5	125	59	8.25	\$440	N/A	\$260	N/A
Z12L2SHSR	23.4 x 12 x 28-28.5	125	53	6.75	\$411	N/A	\$235	N/A
Z21M2SHSR	19.3 x 21 x 28-28.5	125	61	9.50	\$433	N/A	\$324	N/A
Z18M2SHSR	19.3 x 18 x 28-28.5	125	56	8.25	\$414	N/A	\$295	N/A
Z16M2SHSR	19.3 x 16 x 28-28.5	125	52	7	\$392	N/A	\$289	N/A
Z15M2SHSR	19.3 x 15 x 28-28.5	125	52	6.75	\$371	N/A	\$260	N/A
Z12M2SHSR	19.3 x 12 x 28-28.5	100	47	5.75	\$348	N/A	\$235	N/A

For use **under 29" H** returns, extended corners, freestanding and connectable tables of the same depth. **No top or back. One adjustable shelf.** Standard with lock.

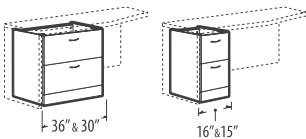

File/File Shell

Z36L2ES	23.4 x 36 x 28-28.5	125	121	18.50	\$1105	N/A	N/A	N/A
Z30L2ES	23.4 x 30 x 28-28.5	125	110	15.50	\$1013	N/A	N/A	N/A
Z16L2ES	23.4 x 16 x 28-28.5	100	75	9	\$609	N/A	N/A	N/A
Z15L2ES	23.4 x 15 x 28-28.5	100	75	8.25	\$594	N/A	N/A	N/A
Z36M2ES	19.3 x 36 x 28-28.5	125	114	15.50	\$1017	N/A	N/A	N/A
Z30M2ES	19.3 x 30 x 28-28.5	125	102	13.25	\$950	N/A	N/A	N/A
Z16M2ES	19.3 x 16 x 28-28.5	100	69	7	\$557	N/A	N/A	N/A
Z15M2ES	19.3 x 15 x 28-28.5	92.5	68	6.75	\$543	N/A	N/A	N/A

For use **under 29" H** returns, extended corners, freestanding and connectable tables of the same depth. **No top or back. Two file drawers.** Lock secures all drawers. 36" and 30" wide models have front-to-back and side-to-side letter/legal filing capability. Side-to-side file bars included.

- 15" wide models have only side-to-side filing capability
- Lateral file drawer construction is for accommodating hanging files NOT for stacking materials on the drawer bottom.

Required Specifications

Base finish
Handles

Optional Specifications

Glazed doors - storage shell doors*
Key #

STORAGE SHELLS - 28" HIGH

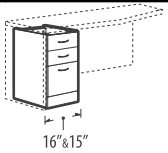

Box/Box/File Shell*

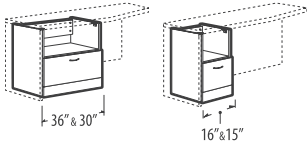

File Shell with Open Shelf*

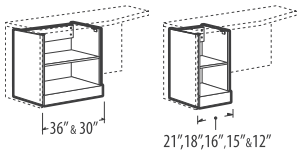

Open Shelving Shell

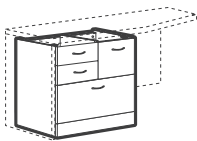

Mixed Storage Shell - LEFT*

MODEL#	DIMENSIONS	FREIGHT CLASS	WT/LBS.	CUBIC FT.	1" TOP	1.5" TOP	GLAZE ADD	HP ADD
D x W x H								
Z16L2BFS	23.4 x 16 x 28-28.5	100	77	9	\$702	N/A	N/A	N/A
Z15L2BFS	23.4 x 15 x 28-28.5	100	77	8.25	\$688	N/A	N/A	N/A
Z16M2BFS	19.3 x 16 x 28-28.5	92.5	71	7	\$636	N/A	N/A	N/A
Z15M2BFS	19.3 x 15 x 28-28.5	92.5	71	6.75	\$624	N/A	N/A	N/A

For use **under 29"H** returns, extended corners, freestanding and connectable tables of the same depth. **No top or back. Two box and one file drawer.** One pencil tray. Lock secures all drawers.

- 15" wide models have only side-to-side filing capability

Z36L2FS	23.4 x 36 x 28-28.5	150	109	18.50	\$860	N/A	N/A	N/A
Z30L2FS	23.4 x 30 x 28-28.5	125	98	15.50	\$772	N/A	N/A	N/A
Z16L2FS	23.4 x 16 x 28-28.5	125	68	9	\$513	N/A	N/A	N/A
Z15L2FS	23.4 x 15 x 28-28.5	100	67	8.25	\$507	N/A	N/A	N/A
Z36M2FS	19.3 x 36 x 28-28.5	125	99	15.50	\$764	N/A	N/A	N/A
Z30M2FS	19.3 x 30 x 28-28.5	125	89	13.25	\$703	N/A	N/A	N/A
Z16M2FS	19.3 x 16 x 28-28.5	100	59	7	\$432	N/A	N/A	N/A
Z15M2FS	19.3 x 15 x 28-28.5	100	57	6.75	\$423	N/A	N/A	N/A

For use **under 29"H** returns, extended corners, freestanding and connectable tables of the same depth. **No top or back. One file drawer.** Lock secures file drawer. 36" and 30" wide models have front-to-back and side-to-side letter/legal filing capability. Side-to-side file bars included.

- 15" wide models have only side-to-side filing capability
- Lateral file drawer construction is for accommodating hanging files NOT for stacking materials on the drawer bottom.

Z36L2SHSN	23.4 x 36 x 28-28.5	150	84.03	18.50	\$525	N/A	N/A	N/A
Z30L2SHSN	23.4 x 30 x 28-28.5	150	74.69	15.50	\$465	N/A	N/A	N/A
Z21L2SHSN	23.4 x 21 x 28-28.5	150	60.69	11	\$391	N/A	N/A	N/A
Z18L2SHSN	23.4 x 18 x 28-28.5	150	56.02	9.75	\$377	N/A	N/A	N/A
Z16L2SHSN	23.4 x 16 x 28-28.5	150	52.90	9	\$350	N/A	N/A	N/A
Z15L2SHSN	23.4 x 15 x 28-28.5	125	52.35	8.25	\$342	N/A	N/A	N/A
Z12L2SHSN	23.4 x 12 x 28-28.5	125	47.68	6.75	\$321	N/A	N/A	N/A
Z36M2SHSN	19.3 x 36 x 28-28.5	150	73.03	15.50	\$435	N/A	N/A	N/A
Z30M2SHSN	19.3 x 30 x 28-28.5	150	64.69	13.25	\$395	N/A	N/A	N/A
Z21M2SHSN	19.3 x 21 x 28-28.5	150	51.69	9.50	\$317	N/A	N/A	N/A
Z18M2SHSN	19.3 x 18 x 28-28.5	150	48.02	8.25	\$305	N/A	N/A	N/A
Z16M2SHSN	19.3 x 16 x 28-28.5	125	44.90	7	\$286	N/A	N/A	N/A
Z15M2SHSN	19.3 x 15 x 28-28.5	125	45.35	6.75	\$274	N/A	N/A	N/A
Z12M2SHSN	19.3 x 12 x 28-28.5	125	41.68	5.75	\$257	N/A	N/A	N/A

For use **under 29"H** returns, extended corners, freestanding and connectable tables of the same depth. **No top or back. One adjustable shelf.**

Z36L2XSL	23.4 x 36 x 28-28.5	100	152	18.50	\$1330	N/A	N/A	N/A
Z30L2XSL	23.4 x 30 x 28-28.5	100	136	15.50	\$1218	N/A	N/A	N/A
Z36M2XSL	19.3 x 36 x 28-28.5	100	139	15.50	\$1254	N/A	N/A	N/A
Z30M2XSL	19.3 x 30 x 28-28.5	100	124	13.25	\$1165	N/A	N/A	N/A

For use **under 29"H** returns, extended corners, freestanding and connectable tables of the same depth. **No top or back.** Two box drawers on **left**, one file drawer on **right** and one lateral file drawer on bottom. Right lock secures one file drawer, the left lock secures two box and the lateral file. One pencil tray. Front-to-back and side-to-side letter/legal filing capability. Side-to-side file bars included.

- Lateral file drawer construction is for accommodating hanging files NOT for stacking materials on the drawer bottom.
- Top file drawer supports hanging folders only. Does not accept hanging folders with plastic tabs.

Required Specifications

Base finish
Handles*

Optional Specifications

Box Drawer Option (no upcharge - not available on Open Shelving Shell)
Key #

STORAGE SHELLS - 28" HIGH

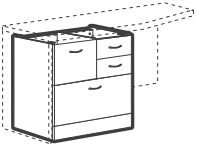

Mixed Storage Shell - RIGHT**

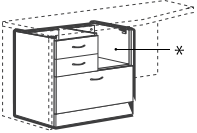

* Accepts collator

Mixed Storage Shell with Open Shelf - LEFT*

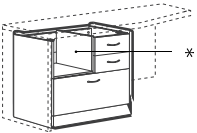

* Accepts collator

Mixed Storage Shell with Open Shelf - RIGHT*

MODEL#	DIMENSIONS D x W x H	FREIGHT CLASS	WT/LBS.	CUBIC FT.	1" TOP	1.5" TOP	GLAZE ADD	HP ADD
Z36L2XSR	23.4 x 36 x 28-28.5	100	152	18.50	\$1330	N/A	N/A	N/A
Z30L2XSR	23.4 x 30 x 28-28.5	100	136	15.50	\$1218	N/A	N/A	N/A
Z36M2XSR	19.3 x 36 x 28-28.5	100	139	15.50	\$1254	N/A	N/A	N/A
Z30M2XSR	19.3 x 30 x 28-28.5	100	124	13.25	\$1165	N/A	N/A	N/A

For use **under 29" H** returns, extended corners, freestanding and connectable tables of the same depth. **No top or back.** Two box drawers on **right**, one file drawer on **left** and one lateral file drawer on bottom. Right lock secures two box and lateral file, the left lock secures one file drawer. One pencil tray. Front-to-back and side-to-side letter/legal filing capability. Side-to-side file bars included.

- Lateral file drawer construction is for accommodating hanging files NOT for stacking materials on the drawer bottom.
- Top file drawer supports hanging folders only. Does not accept hanging folders with plastic tabs.

Z36L2XNSL	23.4 x 36 x 28-28.5	125	133	18.50	\$1124	N/A	N/A	N/A
Z30L2XNSL	23.4 x 30 x 28-28.5	125	121	15.50	\$1023	N/A	N/A	N/A
Z36M2XNSL	19.3 x 36 x 28-28.5	125	121	15.50	\$1047	N/A	N/A	N/A
Z30M2XNSL	19.3 x 30 x 28-28.5	100	109	13.25	\$975	N/A	N/A	N/A

For use **under 29" H** returns, extended corners, freestanding and connectable tables of the same depth. **No top or back.** Two box drawers on **left**, one open shelf on **right** and one lateral file drawer on bottom. Lock secures all drawers. One pencil tray. Front-to-back and side-to-side letter/legal filing capability. Side-to-side file bars included.

- Lateral file drawer construction is for accommodating hanging files NOT for stacking materials on the drawer bottom.

Z36L2XNSR	23.4 x 36 x 28-28.5	125	133	18.50	\$1124	N/A	N/A	N/A
Z30L2XNSR	23.4 x 30 x 28-28.5	125	121	15.50	\$1023	N/A	N/A	N/A
Z36M2XNSR	19.3 x 36 x 28-28.5	125	121	15.50	\$1047	N/A	N/A	N/A
Z30M2XNSR	19.3 x 30 x 28-28.5	100	109	13.25	\$975	N/A	N/A	N/A

For use **under 29" H** returns, extended corners, freestanding and connectable tables of the same depth. **No top or back.** Two box drawers on **right**, one open shelf on **left** and one lateral file drawer on bottom. Lock secures all drawers. One pencil tray. Front-to-back and side-to-side letter/legal filing capability. Side-to-side file bars included.

- Lateral file drawer construction is for accommodating hanging files NOT for stacking materials on the drawer bottom.

Required Specifications

Base finish
Handles

Optional Specifications

Box drawer - no upcharge
Collator (open shelves)

TOP AND BACK KITS FOR 28" H STORAGE SHELLS

MODEL#	DIMENSIONS	FREIGHT CLASS	WT/LBS.	CUBIC FT.	1" TOP	1.5" TOP	GLAZE ADD	HP ADD
D x W x H								
Z2496TB	24 x 96 x 29-29.5	70	126	7.75	\$699	\$830	N/A	\$389
Z2490TB	24 x 90 x 29-29.5	70	118	7.25	\$659	\$782	N/A	\$365
Z2484TB	24 x 84 x 29-29.5	70	111	6.75	\$620	\$735	N/A	\$341
Z2478TB	24 x 78 x 29-29.5	70	104	6.25	\$578	\$685	N/A	\$316
Z2472TB	24 x 72 x 29-29.5	70	117	5.90	\$511	\$631	N/A	\$287
Z2466TB	24 x 66 x 29-29.5	70	117	5.90	\$492	\$602	N/A	\$287
Z2460TB	24 x 60 x 29-29.5	70	117	5.90	\$448	\$547	N/A	\$238
Z2454TB	24 x 54 x 29-29.5	70	72	4.50	\$413	\$487	N/A	\$219
Z2448TB	24 x 48 x 29-29.5	70	66	4	\$377	\$443	N/A	\$195
Z2442TB	24 x 42 x 29-29.5	70	57	3.75	\$336	\$394	N/A	\$171
Z2436TB	24 x 36 x 29-29.5	70	49	3.25	\$284	\$334	N/A	\$146
Z2430TB	24 x 30 x 29-29.5	85	41	2.75	\$252	\$293	N/A	\$122
Z2096TB	20 x 96 x 29-29.5	85	116	7.75	\$659	\$768	N/A	\$325
Z2090TB	20 x 90 x 29-29.5	70	102	6.75	\$621	\$723	N/A	\$304
Z2084TB	20 x 84 x 29-29.5	70	102	6.75	\$584	\$680	N/A	\$284
Z2078TB	20 x 78 x 29-29.5	70	95	6.25	\$545	\$634	N/A	\$264
Z2072TB	20 x 72 x 29-29.5	70	106	6	\$492	\$591	N/A	\$287
Z2066TB	20 x 66 x 29-29.5	70	106	6	\$483	\$567	N/A	\$287
Z2060TB	20 x 60 x 29-29.5	70	106	6	\$423	\$512	N/A	\$238
Z2054TB	20 x 54 x 29-29.5	85	66	4.50	\$390	\$452	N/A	\$183
Z2048TB	20 x 48 x 29-29.5	70	61	4	\$356	\$411	N/A	\$163
Z2042TB	20 x 42 x 29-29.5	85	52	3.75	\$317	\$365	N/A	\$142
Z2036TB	20 x 36 x 29-29.5	85	45	3.25	\$268	\$309	N/A	\$122
Z2030TB	20 x 30 x 29-29.5	85	38	2.75	\$238	\$272	N/A	\$102

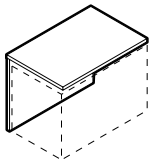

Top and Back Kits - 29"H

For use with 28" high storage shells. Shipped RTA (ready to assemble).

Required Specifications

- Top finish
- Top/edge detail
- Base finish

Optional Specifications

- HP laminate

STORAGE MODULES - 17.87"/18.37" HIGH

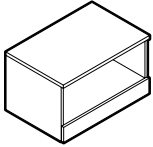

Open Storage

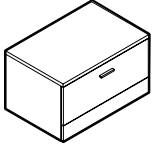

Lateral File*

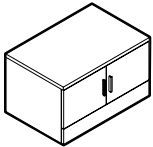

Storage Cabinet*



Glazed door option

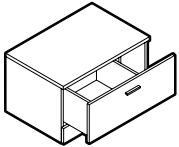

Split Drawer Storage* - LEFT

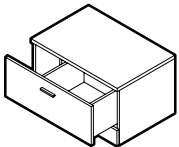

Split Drawer Storage* - RIGHT

MODEL#	DIMENSIONS D x W x H	FREIGHT CLASS	WT/LBS.	CUBIC FT.	1" TOP	1.5" TOP	GLAZE ADD	HP ADD
Z36L21SHN	24 x 36 x 17.87-18.37	125	82	11.75	\$565	\$615	N/A	\$146
Z30L21SHN	24 x 30 x 17.87-18.37	125	74	10	\$518	\$559	N/A	\$122
Z36M21SHN	20 x 36 x 17.87-18.37	125	71	10	\$512	\$553	N/A	\$122
Z30M21SHN	20 x 30 x 17.87-18.37	125	62	8.50	\$461	\$495	N/A	\$102

Open Shelf.

Z36L21E	24 x 36 x 17.87-18.37	100	103	11.75	\$835	\$885	N/A	\$146
Z30L21E	24 x 30 x 17.87-18.37	100	97	10	\$713	\$754	N/A	\$122
Z36M21E	20 x 36 x 17.87-18.37	100	95	10	\$793	\$834	N/A	\$122
Z30M21E	20 x 30 x 17.87-18.37	92.5	88	8.50	\$666	\$700	N/A	\$102

One file drawer. Lock secures drawer. 36" and 30" wide models have front-to-back and side-to-side letter/legal filing capability. Side-to-side file bars included.

- Lateral file drawer construction is for accommodating hanging files NOT for stacking materials on the drawer bottom

Z36L21SH	24 x 36 x 17.87-18.37	125	90	11.75	\$724	\$774	\$304	\$146
Z30L21SH	24 x 30 x 17.87-18.37	100	81	10	\$665	\$706	\$271	\$122
Z36M21SH	20 x 36 x 17.87-18.37	100	80	10	\$671	\$712	\$304	\$122
Z30M21SH	20 x 30 x 17.87-18.37	100	69	8.50	\$608	\$642	\$271	\$102

Laminate doors are standard. Standard with lock.

Z36L21XHL	24 x 36 x 17.87-18.37	100	102	11.75	\$785	\$835	N/A	\$146
Z30L21XHL	24 x 30 x 17.87-18.37	100	92	10	\$697	\$738	N/A	\$122
Z36M21XHL	20 x 36 x 17.87-18.37	100	95	10	\$743	\$784	N/A	\$122
Z30M21XHL	20 x 30 x 17.87-18.37	100	83	8.50	\$650	\$684	N/A	\$102

Pull out drawer includes filing space on **left** and storage on **right**. Lock secures drawer. 36" and 30" wide models have front-to-back letter filing capability.

- Lateral file drawer construction is for accommodating hanging files NOT for stacking materials on the drawer bottom

Z36L21XHR	24 x 36 x 17.87-18.37	100	102	11.75	\$785	\$835	N/A	\$146
Z30L21XHR	24 x 30 x 17.87-18.37	100	92	10	\$697	\$738	N/A	\$122
Z36M21XHR	20 x 36 x 17.87-18.37	100	95	10	\$743	\$784	N/A	\$122
Z30M21XHR	20 x 30 x 17.87-18.37	100	83	8.50	\$650	\$684	N/A	\$102

Pull out drawer includes filing space on **right** and storage on **left**. Lock secures drawer. 36" and 30" wide models have front-to-back letter filing capability.

- Lateral file drawer construction is for accommodating hanging files NOT for stacking materials on the drawer bottom

Required Specifications

Top finish
Top/edge detail
Base finish
Handles*

Optional Specifications

HP laminate
Key #

STORAGE MODULES - 23.75" / 24.25" HIGH

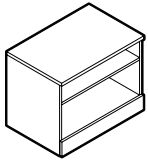

1.5H Open Storage

MODEL#	DIMENSIONS D x W x H	FREIGHT CLASS	WT/LBS.	CUBIC FT.	1" TOP	1.5" TOP	GLAZE ADD	HP ADD
Z36L2HSHN	24 x 36 x 23.75-24.25	125	106	15	\$695	\$745	N/A	\$146
Z30L2HSHN	24 x 30 x 23.75-24.25	125	94	12.75	\$630	\$671	N/A	\$122
Z36M2HSHN	20 x 36 x 23.75-24.25	125	92	12.75	\$626	\$667	N/A	\$122
Z30M2HSHN	20 x 30 x 23.75-24.25	125	80	10.75	\$562	\$596	N/A	\$102

One adjustable shelf.

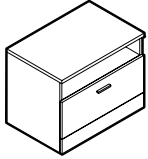

1.5H Open/Lateral File Storage*

Z36L2HFN	24 x 36 x 23.75-24.25	100	127	15	\$964	\$1014	N/A	\$146
Z30L2HFN	24 x 30 x 23.75-24.25	100	118	12.75	\$824	\$865	N/A	\$122
Z36M2HFN	20 x 36 x 23.75-24.25	100	116	12.75	\$907	\$948	N/A	\$122
Z30M2HFN	20 x 30 x 23.75-24.25	100	106	10.75	\$766	\$800	N/A	\$102

Open shelf on top. Lateral file below. Lock secures drawer. 36" and 30" wide models have front-to-back and side-to-side letter/legal filing capability. Side-to-side file bars included.

- Lateral file drawer construction is for accommodating hanging files NOT for stacking materials on the drawer bottom

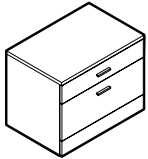

1.5H Box/Lateral File Storage*

Z36L2HE	24 x 36 x 23.75-24.25	100	126	15	\$1019	\$1069	N/A	\$146
Z30L2HE	24 x 30 x 23.75-24.25	100	118	12.75	\$1019	\$1060	N/A	\$122
Z36M2HE	20 x 36 x 23.75-24.25	100	118	12.75	\$974	\$1015	N/A	\$122
Z30M2HE	20 x 30 x 23.75-24.25	92.5	108	10.75	\$828	\$862	N/A	\$102

Box drawer on top. Lateral file below. Lock secures both drawers. 36" and 30" wide models have front-to-back and side-to-side letter/legal filing capability. Side-to-side file bars included.

- Lateral file drawer construction is for accommodating hanging files NOT for stacking materials on the drawer bottom

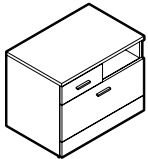

1.5H Mixed Storage - LEFT*

Z36L2HXNL	24 x 36 x 23.75-24.25	100	132	15	\$1053	\$1103	N/A	\$146
Z30L2HXNL	24 x 30 x 23.75-24.25	100	123	12.75	\$914	\$955	N/A	\$122
Z36M2HXNL	20 x 36 x 23.75-24.25	100	121	12.75	\$998	\$1039	N/A	\$122
Z30M2HXNL	20 x 30 x 23.75-24.25	92.5	111	10.75	\$858	\$892	N/A	\$102

Open shelf on **right**, box drawer on **left** and lateral file storage below. Lock secures both drawers. 36" and 30" wide models have front-to-back letter filing capability.

- Lateral file drawer construction is for accommodating hanging files NOT for stacking materials on the drawer bottom

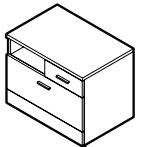

1.5H Mixed Storage - RIGHT*

Z36L2HXNR	24 x 36 x 23.75-24.25	100	132	15	\$1053	\$1103	N/A	\$146
Z30L2HXNR	24 x 30 x 23.75-24.25	100	123	12.75	\$914	\$955	N/A	\$122
Z36M2HXNR	20 x 36 x 23.75-24.25	100	121	12.75	\$998	\$1039	N/A	\$122
Z30M2HXNR	20 x 30 x 23.75-24.25	92.5	111	10.75	\$858	\$892	N/A	\$102

Open shelf on **left**, box drawer on **right** and lateral file storage below. Lock secures both drawers. 36" and 30" wide models have front-to-back letter filing capability.

- Lateral file drawer construction is for accommodating hanging files NOT for stacking materials on the drawer bottom

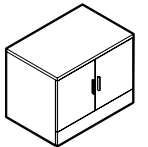

Closed Storage**



Glazed door option

Z36L2HSH	24 x 36 x 23.75-24.25	125	119	15	\$884	\$934	\$379	\$146
Z30L2HSH	24 x 30 x 23.75-24.25	100	105	12.75	\$801	\$842	\$336	\$122
Z36M2HSH	20 x 36 x 23.75-24.25	100	105	12.75	\$816	\$857	\$379	\$122
Z30M2HSH	20 x 30 x 23.75-24.25	100	91	10.75	\$733	\$767	\$336	\$102

Laminate doors are standard. Includes one adjustable shelf. Standard with lock.

Required Specifications

Top finish
Top/edge detail
Base finish
Handles*

Optional Specifications

HP laminate
Key #
Glazed doors**

STORAGE MODULES - 23.75" / 24.25" HIGH

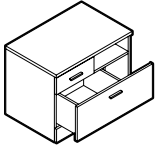

1.5H Split Drawer Storage - LEFT

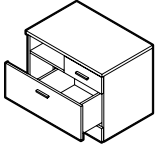

1.5H Split Drawer Storage - RIGHT

MODEL#	DIMENSIONS D x W x H	FREIGHT CLASS	WT/LBS.	CUBIC FT.	1" TOP	1.5" TOP	GLAZE ADD	HP ADD
Z36L2HXHL	24 x 36 x 23.75-24.25	100	132	15	\$1011	\$1061	N/A	\$146
Z30L2HXHL	24 x 30 x 23.75-24.25	100	118	12.75	\$907	\$948	N/A	\$122
Z36M2HXHL	20 x 36 x 23.75-24.25	100	121	12.75	\$956	\$997	N/A	\$122
Z30M2HXHL	20 x 30 x 23.75-24.25	100	107	10.75	\$851	\$885	N/A	\$102

Open shelf on **right**, box drawer on **left**. Pull out drawer includes filing space on **left** and storage on **right**.

Z36L2HXHR	24 x 36 x 23.75-24.25	100	132	15	\$1011	\$1061	N/A	\$146
Z30L2HXHR	24 x 30 x 23.75-24.25	100	118	12.75	\$907	\$948	N/A	\$122
Z36M2HXHR	20 x 36 x 23.75-24.25	100	121	12.75	\$956	\$997	N/A	\$122
Z30M2HXHR	20 x 30 x 23.75-24.25	100	107	10.75	\$851	\$885	N/A	\$102

Open shelf on **left**, box drawer on **right**. Pull out drawer includes filing space on **right** and storage on **left**.

STORAGE MODULES - 29" / 29.5" HIGH

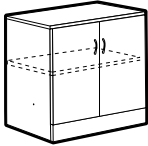

Storage Cabinet with Doors*



Glazed door option

MODEL#	DIMENSIONS	FREIGHT CLASS	WT/LBS.	CUBIC FT.	1" TOP	1.5" TOP	GLAZE ADD	HP ADD
Z36L2SH	24 x 36 x 29.5-30	125	142.80	18.50	\$981	\$1039	\$572	\$145
Z30L2SH	24 x 30 x 29.5-30	125	123.90	15.50	\$882	\$931	\$525	\$121
Z36M2SH	20 x 36 x 29.5-30	100	126	15.50	\$900	\$951	\$572	\$145
Z30M2SH	20 x 30 x 29.5-30	100	109.20	13.25	\$816	\$858	\$525	\$121
Z36S2SH	16 x 36 x 29.5-30	100	110.25	12.50	\$831	\$880	\$572	\$109
Z30S2SH	16 x 30 x 29.5-30	100	93.45	10.50	\$732	\$765	\$525	\$97

Laminate doors are standard. **Includes one adjustable shelf.** Standard with lock.

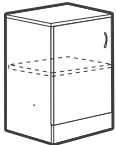

Storage Cabinet with Door - LEFT*

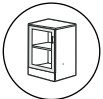

Glazed door option

Z21L2SHL	24 x 21 x 29.5-30	100	94.50	11	\$719	\$759	\$324	\$97
Z18L2SHL	24 x 18 x 29.5-30	100	85.05	9.75	\$678	\$712	\$295	\$74
Z16L2SHL	24 x 16 x 29.5-30	100	79.80	9	\$650	\$683	\$289	\$56
Z15L2SHL	24 x 15 x 29.5-30	100	76.65	8.25	\$601	\$629	\$260	\$56
Z12L2SHL	24 x 12 x 29.5-30	92.5	68.25	6.75	\$569	\$592	\$235	\$50
Z21M2SHL	20 x 21 x 29.5-30	100	84	9.50	\$637	\$671	\$324	\$74
Z18M2SHL	20 x 18 x 29.5-30	100	75.60	8.25	\$603	\$633	\$295	\$74
Z16M2SHL	20 x 16 x 29.5-30	100	69.30	7	\$572	\$601	\$289	\$56
Z15M2SHL	20 x 15 x 29.5-30	100	66.15	6.75	\$545	\$570	\$260	\$50
Z12M2SHL	20 x 12 x 29.5-30	92.5	60	5.75	\$507	\$527	\$235	\$50
Z21S2SHL	16 x 21 x 29.5-30	100	71.40	7.50	\$583	\$610	\$324	\$50
Z18S2SHL	16 x 18 x 29.5-30	100	64.05	6.75	\$558	\$586	\$295	\$50
Z16S2SHL	16 x 16 x 29.5-30	100	58.80	6	\$533	\$561	\$289	\$50
Z15S2SHL	16 x 15 x 29.5-30	100	56.70	5.75	\$503	\$526	\$260	\$50
Z12S2SHL	16 x 12 x 29.5-30	92.5	50.40	4.75	\$468	\$488	\$235	\$50

Laminate doors are standard. **Includes one adjustable shelf.** Standard with lock.

Required Specifications

- Top finish
- Handles
- Top/edge detail
- Base finish

Optional Specifications

- Glazed doors*
- HP laminate
- Key #

STORAGE MODULES - 29" / 29.5" HIGH

MODEL# DIMENSIONS FREIGHT CLASS WT/LBS. CUBIC FT. 1" TOP 1.5" TOP GLAZE ADD HP ADD

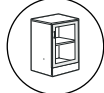
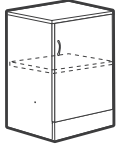

Glazed door option

Storage Cabinet with Door - RIGHT**

	D x W x H								
Z21L2SHR	24 x 21 x 29.5-30	100	94.50	11	\$719	\$759	\$324	\$97	
Z18L2SHR	24 x 18 x 29.5-30	100	85.05	9.75	\$678	\$712	\$295	\$74	
Z16L2SHR	24 x 16 x 29.5-30	100	79.80	9	\$650	\$683	\$289	\$56	
Z15L2SHR	24 x 15 x 29.5-30	100	76.65	8.25	\$601	\$629	\$260	\$56	
Z12L2SHR	24 x 12 x 29.5-30	92.5	68.25	6.75	\$569	\$592	\$235	\$50	
Z21M2SHR	20 x 21 x 29.5-30	100	84	9.50	\$637	\$671	\$324	\$74	
Z18M2SHR	20 x 18 x 29.5-30	100	75.60	8.25	\$603	\$633	\$295	\$74	
Z16M2SHR	20 x 16 x 29.5-30	100	69.30	7	\$572	\$601	\$289	\$56	
Z15M2SHR	20 x 15 x 29.5-30	100	66.15	6.75	\$545	\$570	\$260	\$50	
Z12M2SHR	20 x 12 x 29.5-30	92.5	60	5.75	\$507	\$527	\$235	\$50	
Z21S2SHR	16 x 21 x 29.5-30	100	71.40	7.50	\$583	\$610	\$324	\$50	
Z18S2SHR	16 x 18 x 29.5-30	100	64.05	6.75	\$558	\$586	\$295	\$50	
Z16S2SHR	16 x 16 x 29.5-30	100	58.80	6	\$533	\$561	\$289	\$50	
Z15S2SHR	16 x 15 x 29.5-30	100	56.70	5.75	\$503	\$526	\$260	\$50	
Z12S2SHR	16 x 12 x 29.5-30	92.5	50.40	4.75	\$468	\$488	\$235	\$50	

Laminate doors are standard. Includes one adjustable shelf. Standard with lock

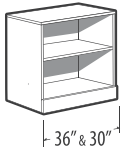

36" & 30"

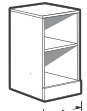

21", 18", 16", 15" & 12"

Open Storage Cabinet

Z36L2SHN	24 x 36 x 29.5-30	125	127	18.50	\$773	\$831	N/A	\$145	
Z30L2SHN	24 x 30 x 29.5-30	125	111	15.50	\$694	\$744	N/A	\$121	
Z21L2SHN	24 x 21 x 29.5-30	125	86	11	\$603	\$643	N/A	\$97	
Z18L2SHN	24 x 18 x 29.5-30	100	78	9.75	\$570	\$604	N/A	\$74	
Z16L2SHN	24 x 16 x 29.5-30	100	73	9	\$545	\$578	N/A	\$56	
Z15L2SHN	24 x 15 x 29.5-30	100	71	8.25	\$505	\$533	N/A	\$50	
Z12L2SHN	24 x 12 x 29.5-30	100	63	6.75	\$478	\$501	N/A	\$50	
Z36M2SHN	20 x 36 x 29.5-30	125	111.95	15.50	\$690	\$740	N/A	\$109	
Z30M2SHN	20 x 30 x 29.5-30	125	97.14	13.25	\$627	\$670	N/A	\$97	
Z21M2SHN	20 x 21 x 29.5-30	125	74.40	9.50	\$522	\$556	N/A	\$74	
Z18M2SHN	20 x 18 x 29.5-30	100	67.53	8.25	\$495	\$525	N/A	\$61	
Z16M2SHN	20 x 16 x 29.5-30	100	62.59	7	\$467	\$496	N/A	\$50	
Z15M2SHN	20 x 15 x 29.5-30	100	60.65	6.75	\$446	\$471	N/A	\$50	
Z12M2SHN	20 x 12 x 29.5-30	100	55	5.75	\$415	\$436	N/A	\$50	
Z36S2SHN	16 x 36 x 29.5-30	125	96.24	12.50	\$622	\$671	N/A	\$109	
Z30S2SHN	16 x 30 x 29.5-30	125	82.82	10.50	\$543	\$576	N/A	\$97	
Z21S2SHN	16 x 21 x 29.5-30	100	62.70	7.50	\$467	\$494	N/A	\$74	
Z18S2SHN	16 x 18 x 29.5-30	100	55.99	6.75	\$451	\$480	N/A	\$61	
Z16S2SHN	16 x 16 x 29.5-30	100	52.22	6	\$429	\$457	N/A	\$50	
Z15S2SHN	16 x 15 x 29.5-30	100	50.34	5.75	\$405	\$427	N/A	\$50	
Z12S2SHN	16 x 12 x 29.5-30	100	44.68	4.75	\$376	\$396	N/A	\$50	

One adjustable shelf.

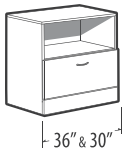

36" & 30"



16" & 15"

File Module with Open Shelf*

Z36L2FN	24 x 36 x 29.5-30	100	153.30	18.50	\$1107	\$1164	N/A	\$145	
Z30L2FN	24 x 30 x 29.5-30	100	134.40	15.50	\$1000	\$1050	N/A	\$121	
Z16L2FN	24 x 16 x 29.5-30	100	87.15	9	\$699	\$732	N/A	\$74	
Z15L2FN	24 x 15 x 29.5-30	92.5	82.95	8.25	\$658	\$686	N/A	\$61	
Z36M2FN	20 x 36 x 29.5-30	100	135.45	15.50	\$1023	\$1073	N/A	\$145	
Z30M2FN	20 x 30 x 29.5-30	100	118.65	13.25	\$941	\$983	N/A	\$121	
Z16M2FN	20 x 16 x 29.5-30	92.5	75.60	7	\$623	\$652	N/A	\$74	
Z15M2FN	20 x 15 x 29.5-30	92.5	72.45	6.75	\$596	\$621	N/A	\$61	
Z36S2FN	16 x 36 x 29.5-30	100	114.45	12.50	\$925	\$974	N/A	\$109	
Z30S2FN	16 x 30 x 29.5-30	100	97.65	10.50	\$819	\$852	N/A	\$97	
Z16S2FN	16 x 16 x 29.5-30	92.5	63	6	\$578	\$606	N/A	\$56	
Z15S2FN	16 x 15 x 29.5-30	92.5	60.90	5.75	\$552	\$574	N/A	\$50	

Open shelf and one file drawer on bottom. Lock secures file drawer. 36" and 30" wide models have front-to-back and side-to-side letter/legal filing capability. Side-to-side file bars included.

- 15" wide models have only side-to-side filing capability
- Lateral file drawer construction is for accommodating hanging files NOT for stacking materials on the drawer bottom

Required Specifications

Top finish
Handles*
Top/edge detail
Base finish

Optional Specifications

Glazed doors**
HP laminate
Key #

STORAGE MODULES - 29" / 29.5" HIGH



36" & 30"



16" & 15"

Two File Module

MODEL#	DIMENSIONS D x W x H	FREIGHT CLASS	WT/LBS.	CUBIC FT.	1" TOP	1.5" TOP	GLAZE ADD	HP ADD
Z36L2E	24 x 36 x 29.5-30	100	164.85	18.50	\$1357	\$1414	N/A	\$145
Z30L2E	24 x 30 x 29.5-30	100	145.95	15.50	\$1241	\$1291	N/A	\$121
Z16L2E	24 x 16 x 29.5-30	92.5	95.55	9	\$799	\$832	N/A	\$74
Z15L2E	24 x 15 x 29.5-30	92.5	91.35	8.25	\$753	\$781	N/A	\$61
Z36M2E	20 x 36 x 29.5-30	100	149.10	15.50	\$1282	\$1333	N/A	\$145
Z30M2E	20 x 30 x 29.5-30	92.5	133.35	13.25	\$1189	\$1232	N/A	\$121
Z16M2E	20 x 16 x 29.5-30	85	85.05	7	\$725	\$754	N/A	\$74
Z15M2E	20 x 15 x 29.5-30	85	81.90	6.75	\$700	\$725	N/A	\$61
Z36S2E	16 x 36 x 29.5-30	92.5	128.10	12.50	\$1203	\$1252	N/A	\$109
Z30S2E	16 x 30 x 29.5-30	92.5	110.25	10.50	\$1092	\$1125	N/A	\$97
Z16S2E	16 x 16 x 29.5-30	85	73.50	6	\$719	\$747	N/A	\$56
Z15S2E	16 x 15 x 29.5-30	85	71.40	5.75	\$694	\$717	N/A	\$50

Two file drawers. Lock secures all drawers. 36" and 30" wide models have front-to-back and side-to-side letter/legal filing capability. Side-to-side file bars included.

- 15" wide models have only side-to-side filing capability
- Lateral file drawer construction is for accommodating hanging files NOT for stacking materials on the drawer bottom



Two File Module

Z36L2SE	24 x 36 x 29.5-30	100	180	18.50	\$1594	\$1651	N/A	\$145
Z36M2SE	20 x 36 x 29.5-30	92.5	164	15.50	\$1533	\$1584	N/A	\$145

Two lateral file drawers with steel drawer interior. Lock secures all drawers. Front-to-back and side-to-side letter/legal filing capability. Side-to-side file bars included.

- Front-to-back filing bars available separately. Order **FBB** bars. See "FBB" on page 33.
- Lateral file drawer construction is for accommodating hanging files NOT for stacking materials on the drawer bottom
- To prevent overloading, steel drawers do not include a back panel



16" & 15"

Box/Box/File Module

Z16L2BF	24 x 16 x 29.5-30	92.5	97.65	9	\$900	\$933	N/A	\$74
Z15L2BF	24 x 15 x 29.5-30	92.5	93.45	8.25	\$858	\$886	N/A	\$74
Z16M2BF	20 x 16 x 29.5-30	85	87.15	7	\$824	\$853	N/A	\$74
Z15M2BF	20 x 15 x 29.5-30	85	84	6.75	\$803	\$828	N/A	\$74
Z16S2BF	16 x 16 x 29.5-30	85	73.50	6	\$768	\$796	N/A	\$56
Z15S2BF	16 x 15 x 29.5-30	85	71.40	5.75	\$733	\$756	N/A	\$56

Two box and one file drawer. One pencil tray. Lock secures all drawers.



Mixed Storage Cabinet - LEFT

Z36L2XL	24 x 36 x 29.5-30	92.5	187	18.50	\$1547	\$1600	N/A	\$145
Z30L2XL	24 x 30 x 29.5-30	92.5	166	15.50	\$1411	\$1461	N/A	\$121
Z36M2XL	20 x 36 x 29.5-30	92.5	177	15.50	\$1453	\$1503	N/A	\$145
Z30M2XL	20 x 30 x 29.5-30	92.5	152	13.25	\$1337	\$1380	N/A	\$121
Z36S2XL	16 x 36 x 29.5-30	92.5	145	12.50	\$1247	\$1292	N/A	\$109
Z30S2XL	16 x 30 x 29.5-30	92.5	124	10.50	\$1117	\$1156	N/A	\$97

Two box drawers on **left**, one file drawer on **right** and one lateral file drawer on bottom. Right lock secures one file drawer, the left lock secures two box and lateral file. One pencil tray. Front-to-back and side-to-side letter/legal filing capability. Side-to-side file bars included.

- Lateral file drawer construction is for accommodating hanging files NOT for stacking materials on the drawer bottom
- Top file drawer supports hanging folders only. Does not accept hanging folders with plastic tabs.

Required Specifications

Top finish
Top/edge detail
Handles
Base finish

Optional Specifications

HP laminate
Key #
Box drawer - no upcharge

STORAGE MODULES - 29" / 29.5" HIGH



Mixed Storage Cabinet - RIGHT

MODEL#	DIMENSIONS	FREIGHT CLASS	WT/LBS.	CUBIC FT.	1" TOP	1.5" TOP	GLAZE ADD	HP ADD
D x W x H								
Z36L2XR	24 x 36 x 29.5-30	92.5	187	18.50	\$1547	\$1600	N/A	\$145
Z30L2XR	24 x 30 x 29.5-30	92.5	166	15.50	\$1411	\$1461	N/A	\$121
Z36M2XR	20 x 36 x 29.5-30	92.5	177	15.50	\$1453	\$1503	N/A	\$145
Z30M2XR	20 x 30 x 29.5-30	92.5	152	13.25	\$1337	\$1380	N/A	\$121
Z36S2XR	16 x 36 x 29.5-30	92.5	145	12.50	\$1247	\$1292	N/A	\$109
Z30S2XR	16 x 30 x 29.5-30	92.5	124	10.50	\$1117	\$1156	N/A	\$97

Two box drawers on **right**, one file drawer on **left** and one lateral file drawer on bottom. Right lock secures two box and lateral file, the left lock secures one file drawer. One pencil tray. Front-to-back and side-to-side letter/legal filing capability. Side-to-side file bars included.

- Lateral file drawer construction is for accommodating hanging files NOT for stacking materials on the drawer bottom
- Top file drawer supports hanging folders only. Does not accept hanging folders with plastic tabs.

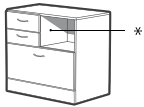

Mixed Drawer Cabinet with Open Shelf - LEFT*



* Accepts collator

Z36L2XNL	24 x 36 x 29.5-30	100	176.40	18.50	\$1339	\$1397	N/A	\$145
Z30L2XNL	24 x 30 x 29.5-30	92.5	155.40	15.50	\$1230	\$1280	N/A	\$121
Z36M2XNL	20 x 36 x 29.5-30	92.5	157.50	15.50	\$1253	\$1303	N/A	\$145
Z30M2XNL	20 x 30 x 29.5-30	92.5	138.60	13.25	\$1159	\$1202	N/A	\$121
Z36S2XNL	16 x 36 x 29.5-30	92.5	128.10	12.50	\$1123	\$1165	N/A	\$109
Z30S2XNL	16 x 30 x 29.5-30	92.5	114.45	10.50	\$1018	\$1047	N/A	\$97

Two box drawers on **left**, open shelf on **right** and one lateral file drawer on bottom. Right lock secures two box and one file drawer, the left lock secures the lateral file. One pencil tray. Front-to-back and side-to-side letter/legal filing capability. Side-to-side file bars included.

- Lateral file drawer construction is for accommodating hanging files NOT for stacking materials on the drawer bottom

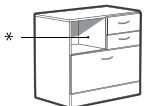

Mixed Drawer Cabinet with Open Shelf - RIGHT*



* Accepts collator

Z36L2XNR	24 x 36 x 29.5-30	100	176.40	18.50	\$1339	\$1397	N/A	\$145
Z30L2XNR	24 x 30 x 29.5-30	92.5	155.40	15.50	\$1230	\$1280	N/A	\$121
Z36M2XNR	20 x 36 x 29.5-30	92.5	157.50	15.50	\$1253	\$1303	N/A	\$145
Z30M2XNR	20 x 30 x 29.5-30	92.5	138.60	13.25	\$1159	\$1202	N/A	\$121
Z36S2XNR	16 x 36 x 29.5-30	92.5	128.10	12.50	\$1123	\$1165	N/A	\$109
Z30S2XNR	16 x 30 x 29.5-30	92.5	114.45	10.50	\$1018	\$1047	N/A	\$97

Two box drawers on **right**, open shelf on **left** and one lateral file drawer on bottom. Right lock secures two box and one file drawer, the left lock secures the lateral file. One pencil tray. Front-to-back and side-to-side letter/legal filing capability. Side-to-side file bars included.

- Lateral file drawer construction is for accommodating hanging files NOT for stacking materials on the drawer bottom



Media Center - LEFT

Z36L2MCL	24 x 36 x 29.5-30	100	171.15	18.50	\$1444	\$1502	N/A	\$145
Z30L2MCL	24 x 30 x 29.5-30	100	152.25	15.50	\$1344	\$1394	N/A	\$121
Z36M2MCL	20 x 36 x 29.5-30	100	153.30	15.50	\$1355	\$1405	N/A	\$145
Z30M2MCL	20 x 30 x 29.5-30	92.5	134.40	13.25	\$1234	\$1277	N/A	\$121
Z36S2MCL	16 x 36 x 29.5-30	92.5	126	12.50	\$1229	\$1278	N/A	\$109
Z30S2MCL	16 x 30 x 29.5-30	92.5	108.15	10.50	\$1110	\$1143	N/A	\$97

Accommodates pc, keyboard, monitor, hanging folders and accessories and/or printer. One vertical drawer on the **left**. Pull out keyboard shelf. Adjustable pull out bottom shelf accommodates pc and/or printer. Grommet in worksurface and back panel. Lock secures vertical drawer.



Media Center - RIGHT

Z36L2MCR	24 x 36 x 29.5-30	100	171.15	18.50	\$1444	\$1502	N/A	\$145
Z30L2MCR	24 x 30 x 29.5-30	100	152.25	15.50	\$1344	\$1394	N/A	\$121
Z36M2MCR	20 x 36 x 29.5-30	100	153.30	15.50	\$1355	\$1405	N/A	\$145
Z30M2MCR	20 x 30 x 29.5-30	92.5	134.40	13.25	\$1234	\$1277	N/A	\$121
Z36S2MCR	16 x 36 x 29.5-30	92.5	126	12.50	\$1229	\$1278	N/A	\$109
Z30S2MCR	16 x 30 x 29.5-30	92.5	108.15	10.50	\$1110	\$1143	N/A	\$97

Accommodates pc, keyboard, monitor, hanging folders and accessories and/or printer. One vertical drawer on the **right**. Pull out keyboard shelf. Adjustable pull out bottom shelf accommodates pc and/or printer. Grommet in worksurface and back panel. Lock secures vertical drawer.

Required Specifications

Top finish
Top/edge detail
Base finish
Handles

Optional Specifications

HP laminate
Key #
Box drawer - no upcharge
Collator*

STORAGE MODULES - 29" / 29.5" HIGH

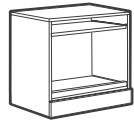

PC Center

MODEL#	DIMENSIONS D x W x H	FREIGHT CLASS	WT/LBS.	CUBIC FT.	1"TOP	1.5" TOP	GLAZE ADD	HP ADD
Z36L2PC	24 x 36 x 29.5-30	100	148.05	18.50	\$945	\$1002	N/A	\$145
Z30L2PC	24 x 30 x 29.5-30	100	127.05	15.50	\$852	\$902	N/A	\$121
Z36M2PC	20 x 36 x 29.5-30	100	132.30	15.50	\$877	\$928	N/A	\$109
Z30M2PC	20 x 30 x 29.5-30	100	114.45	13.25	\$784	\$826	N/A	\$97
Z36S2PC	16 x 36 x 29.5-30	100	110.25	12.50	\$799	\$848	N/A	\$109
Z30S2PC	16 x 30 x 29.5-30	100	92.40	10.50	\$681	\$714	N/A	\$97

Accommodates pc, keyboard, monitor and/or printer. Pull out keyboard shelf. Adjustable pull out bottom shelf accommodates pc and/or printer. Grommet in worksurface and back panel.

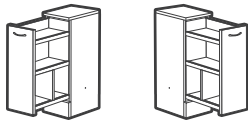

LEFT RIGHT
Vertical Utility Drawer*

Z12L2VDL	24 x 12 x 29.5-30	85	95.55	6.75	\$751	\$774	N/A	\$50
Z12M2VDL	20 x 12 x 29.5-30	85	80.85	5.75	\$655	\$675	N/A	\$50
Z12S2VDL	16 x 12 x 29.5-30	85	68.25	4.75	\$585	\$605	N/A	\$50
Z12L2VDR	24 x 12 x 29.5-30	85	95.55	6.75	\$751	\$774	N/A	\$50
Z12M2VDR	20 x 12 x 29.5-30	85	80.85	5.75	\$655	\$675	N/A	\$50
Z12S2VDR	16 x 12 x 29.5-30	85	68.25	4.75	\$585	\$605	N/A	\$50

Specify **VDL** models for **LEFT** or **VDR** models for **RIGHT**

One vertical drawer. Lock secures vertical drawer.

STORAGE MODULES - 40.8" / 41.3" HIGH

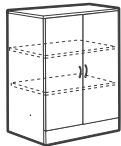

Glazed door option

Storage Cabinet with Doors**

MODEL#	DIMENSIONS	FREIGHT CLASS	WT/LBS.	CUBIC FT.	1"TOP	1.5" TOP	GLAZE ADD	HP ADD
Z36L4SH	24 x 36 x 41.3-41.8	125	185.85	25	\$1196	\$1254	\$763	\$145
Z30L4SH	24 x 30 x 41.3-41.8	125	161.70	21.25	\$1095	\$1144	\$666	\$121
Z36M4SH	20 x 36 x 41.3-41.8	125	165.90	21.25	\$1117	\$1168	\$763	\$145
Z30M4SH	20 x 30 x 41.3-41.8	125	143.85	18	\$1010	\$1053	\$666	\$121
Z36S4SH	16 x 36 x 41.3-41.8	100	142.80	17.50	\$1011	\$1060	\$763	\$109
Z30S4SH	16 x 30 x 41.3-41.8	100	121.80	14.50	\$907	\$940	\$666	\$61

Laminate doors are standard. **Includes two 3-position fixed/height adjustable shelves.** Standard with lock.

Required Specifications

Top finish
Top/edge detail
Handles*
Base finish

Optional Specifications

HP laminate
Glazed doors**
Key #

STORAGE MODULES - 40.8" / 41.3" HIGH

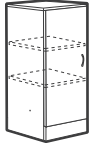

Glazed door option

Storage Cabinet with Door - LEFT*

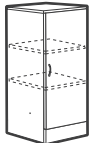

Glazed door option

Storage Cabinet with Door - RIGHT*

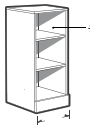

21", 18", 16", 15" & 12"

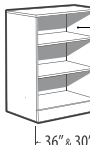

36" & 30"



* Accepts collator 11" high
** Accepts collator 11.3" high

Open Storage Cabinet**

MODEL#	DIMENSIONS	FREIGHT CLASS	WT./LBS.	CUBIC FT.	1" TOP	1.5" TOP	GLAZE ADD	HP ADD
D x W x H								
Z21L4SHL	24 x 21 x 41.3-41.8	100	123.90	15.25	\$887	\$928	\$419	\$97
Z18L4SHL	24 x 18 x 41.3-41.8	100	112.35	13.25	\$835	\$868	\$377	\$74
Z16L4SHL	24 x 16 x 41.3-41.8	100	105	12	\$785	\$819	\$372	\$74
Z15L4SHL	24 x 15 x 41.3-41.8	100	100.80	11.25	\$752	\$779	\$330	\$74
Z12L4SHL	24 x 12 x 41.3-41.8	100	89.25	9.25	\$697	\$720	\$298	\$50
Z21M4SHL	20 x 21 x 41.3-41.8	100	116.55	13	\$800	\$834	\$419	\$97
Z18M4SHL	20 x 18 x 41.3-41.8	100	98.70	11.25	\$757	\$786	\$377	\$74
Z16M4SHL	20 x 16 x 41.3-41.8	100	91.35	10.25	\$710	\$739	\$372	\$61
Z15M4SHL	20 x 15 x 41.3-41.8	100	88.20	9.50	\$680	\$703	\$330	\$61
Z12M4SHL	20 x 12 x 41.3-41.8	100	78.75	8	\$632	\$652	\$298	\$50
Z21S4SHL	16 x 21 x 41.3-41.8	100	94.50	10.50	\$714	\$742	\$419	\$74
Z18S4SHL	16 x 18 x 41.3-41.8	100	84	9.50	\$685	\$713	\$377	\$61
Z16S4SHL	16 x 16 x 41.3-41.8	100	76.65	8.50	\$642	\$670	\$372	\$61
Z15S4SHL	16 x 15 x 41.3-41.8	100	73.50	8	\$607	\$630	\$330	\$61
Z12S4SHL	16 x 12 x 41.3-41.8	92.5	65.10	6.50	\$562	\$581	\$298	\$50

Laminate doors are standard. Includes two 3-position fixed/height adjustable shelves. Standard with lock.

Z21L4SHR	24 x 21 x 41.3-41.8	100	123.90	15.25	\$887	\$928	\$419	\$97
Z18L4SHR	24 x 18 x 41.3-41.8	100	112.35	13.25	\$835	\$868	\$377	\$74
Z16L4SHR	24 x 16 x 41.3-41.8	100	105	12	\$785	\$819	\$372	\$74
Z15L4SHR	24 x 15 x 41.3-41.8	100	100.80	11.25	\$752	\$779	\$330	\$74
Z12L4SHR	24 x 12 x 41.3-41.8	100	89.25	9.25	\$697	\$720	\$298	\$50
Z21M4SHR	20 x 21 x 41.3-41.8	100	116.55	13	\$800	\$834	\$419	\$97
Z18M4SHR	20 x 18 x 41.3-41.8	100	98.70	11.25	\$757	\$786	\$377	\$74
Z16M4SHR	20 x 16 x 41.3-41.8	100	91.35	10.25	\$710	\$739	\$372	\$61
Z15M4SHR	20 x 15 x 41.3-41.8	100	88.20	9.50	\$680	\$703	\$330	\$61
Z12M4SHR	20 x 12 x 41.3-41.8	100	78.75	8	\$632	\$652	\$298	\$50
Z21S4SHR	16 x 21 x 41.3-41.8	100	94.50	10.50	\$714	\$742	\$419	\$74
Z18S4SHR	16 x 18 x 41.3-41.8	100	84	9.50	\$685	\$713	\$377	\$61
Z16S4SHR	16 x 16 x 41.3-41.8	100	76.65	8.50	\$642	\$670	\$372	\$61
Z15S4SHR	16 x 15 x 41.3-41.8	100	73.50	8	\$607	\$630	\$330	\$61
Z12S4SHR	16 x 12 x 41.3-41.8	92.5	65.10	6.50	\$562	\$581	\$298	\$50

Laminate doors are standard. Includes two 3-position fixed/height adjustable shelves. Standard with lock.

Z36L4SHN	24 x 36 x 41.3-41.8	125	162.55	25	\$942	\$999	N/A	\$145
Z30L4SHN	24 x 30 x 41.3-41.8	125	142.46	21.25	\$868	\$918	N/A	\$121
Z21L4SHN	24 x 21 x 41.3-41.8	125	111.80	15.25	\$745	\$785	N/A	\$97
Z18L4SHN	24 x 18 x 41.3-41.8	125	101.23	13.25	\$703	\$737	N/A	\$74
Z16L4SHN	24 x 16 x 41.3-41.8	125	94.53	12	\$656	\$689	N/A	\$74
Z15L4SHN	24 x 15 x 41.3-41.8	100	91.70	11.25	\$635	\$663	N/A	\$74
Z12L4SHN	24 x 12 x 41.3-41.8	100	81.13	9.25	\$589	\$612	N/A	\$50
Z36M4SHN	20 x 36 x 41.3-41.8	125	141.59	21.25	\$862	\$912	N/A	\$145
Z30M4SHN	20 x 30 x 41.3-41.8	125	123.94	18	\$783	\$826	N/A	\$121
Z21M4SHN	20 x 21 x 41.3-41.8	125	102.19	13	\$658	\$692	N/A	\$97
Z18M4SHN	20 x 18 x 41.3-41.8	125	86.54	11.25	\$627	\$656	N/A	\$74
Z16M4SHN	20 x 16 x 41.3-41.8	125	81.01	10.25	\$580	\$609	N/A	\$74
Z15M4SHN	20 x 15 x 41.3-41.8	100	78.24	9.50	\$563	\$586	N/A	\$74
Z12M4SHN	20 x 12 x 41.3-41.8	100	69.95	8	\$524	\$544	N/A	\$50
Z36S4SHN	16 x 36 x 41.3-41.8	125	119.57	17.50	\$754	\$804	N/A	\$109
Z30S4SHN	16 x 30 x 41.3-41.8	125	111.72	14.50	\$680	\$714	N/A	\$97
Z21S4SHN	16 x 21 x 41.3-41.8	125	81.04	10.50	\$572	\$599	N/A	\$74
Z18S4SHN	16 x 18 x 41.3-41.8	125	72.91	9.50	\$554	\$583	N/A	\$61
Z16S4SHN	16 x 16 x 41.3-41.8	125	67.49	8.50	\$512	\$540	N/A	\$61
Z15S4SHN	16 x 15 x 41.3-41.8	100	64.78	8	\$490	\$512	N/A	\$61
Z12S4SHN	16 x 12 x 41.3-41.8	100	57.71	6.50	\$454	\$474	N/A	\$50

Includes two 3-position fixed/height adjustable shelves.

Required Specifications

- Top finish
- Top/edge detail
- Handles*
- Base finish

Optional Specifications

- Glazed door*
- HP laminate
- Collator**

STORAGE MODULES - 40.8" / 41.3" HIGH

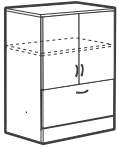

Glazed door option

File Module with Doors*

MODEL#	DIMENSIONS D x W x H	FREIGHT CLASS	WT./LBS.	CUBIC FT.	1" TOP	1.5" TOP	GLAZE ADD	HP ADD
Z36L4F	24 x 36 x 41.3-41.8	100	204.75	25	\$1485	\$1543	\$595	\$145
Z30L4F	24 x 30 x 41.3-41.8	100	179.55	21.25	\$1372	\$1422	\$525	\$121
Z36M4F	20 x 36 x 41.3-41.8	100	183.75	21.25	\$1400	\$1450	\$595	\$145
Z30M4F	20 x 30 x 41.3-41.8	100	160.65	18	\$1287	\$1330	\$525	\$121
Z36S4F	16 x 36 x 41.3-41.8	100	148.05	17.50	\$1263	\$1312	\$595	\$109
Z30S4F	16 x 30 x 41.3-41.8	100	133.35	14.50	\$1144	\$1177	\$525	\$97

One lateral file drawer. Laminate doors are standard. **Includes one 3-position fixed/height adjustable shelf.** Upper lock secures storage compartment. Lower lock secures one file drawer. Front-to-back and side-to-side letter/legal filing capability. Side-to-side file bars included.

- Lateral file drawer construction is for accommodating hanging files NOT for stacking materials on the drawer bottom.

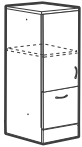

Glazed door option

File Module with Door - LEFT*

Z16L4FL	24 x 16 x 41.3-41.8	100	116.55	12	\$922	\$955	\$289	\$74
Z15L4FL	24 x 15 x 41.3-41.8	100	111.30	11.25	\$887	\$915	\$260	\$74
Z16M4FL	20 x 16 x 41.3-41.8	100	101.85	10.25	\$858	\$887	\$289	\$74
Z15M4FL	20 x 15 x 41.3-41.8	92.5	100.80	9.50	\$822	\$845	\$260	\$74
Z16S4FL	16 x 36 x 41.3-41.8	150	84	17.50	\$766	\$794	\$289	\$61
Z15S4FL	16 x 30 x 41.3-41.8	150	82.95	14.50	\$738	\$760	\$260	\$61

One file drawer. Laminate door is standard. **Includes one 3-position fixed/height adjustable shelf.** Upper lock secures storage compartment. Lower lock secures one file drawer.



Glazed door option

File Module with Door - RIGHT*

Z16L4FR	24 x 16 x 41.3-41.8	100	116.55	12	\$922	\$955	\$289	\$74
Z15L4FR	24 x 15 x 41.3-41.8	100	111.30	11.25	\$887	\$915	\$260	\$74
Z16M4FR	20 x 16 x 41.3-41.8	100	101.85	10.25	\$858	\$887	\$289	\$74
Z15M4FR	20 x 15 x 41.3-41.8	92.5	100.80	9.50	\$822	\$845	\$260	\$74
Z16S4FR	16 x 16 x 41.3-41.8	150	84	17.50	\$766	\$794	\$289	\$61
Z15S4FR	16 x 15 x 41.3-41.8	150	82.95	14.50	\$738	\$760	\$260	\$61

One file drawer. Laminate door is standard. **Includes one 3-position fixed/height adjustable shelf.** Upper lock secures storage compartment. Lower lock secures one file drawer.

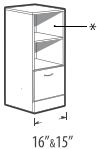
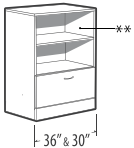

* Accepts collator 11" high
** Accepts collator 11.3" high

File Module with Open Shelves**

Z36L4FN	24 x 36 x 41.3-41.8	125	189.43	25	\$1277	\$1318	N/A	\$145
Z30L4FN	24 x 30 x 41.3-41.8	125	166.96	21.25	\$1184	\$1218	N/A	\$121
Z16L4FN	24 x 16 x 41.3-41.8	100	109.63	12	\$813	\$847	N/A	\$74
Z15L4FN	24 x 15 x 41.3-41.8	100	105.53	11.25	\$789	\$817	N/A	\$74
Z36M4FN	20 x 36 x 41.3-41.8	125	167.42	21.25	\$1191	\$1241	N/A	\$145
Z30M4FN	20 x 30 x 41.3-41.8	100	147.39	18	\$1098	\$1140	N/A	\$121
Z16M4FN	20 x 16 x 41.3-41.8	100	95.06	10.25	\$751	\$780	N/A	\$74
Z15M4FN	20 x 15 x 41.3-41.8	100	94.17	9.50	\$724	\$749	N/A	\$74
Z36S4FN	16 x 36 x 41.3-41.8	125	132.80	17.50	\$1054	\$1103	N/A	\$109
Z30S4FN	16 x 30 x 41.3-41.8	100	119.42	14.50	\$952	\$985	N/A	\$97
Z16S4FN	16 x 16 x 41.3-41.8	100	78.39	8.50	\$636	\$664	N/A	\$61
Z15S4FN	16 x 15 x 41.3-41.8	100	76.51	8	\$621	\$644	N/A	\$61

Two open shelves and one file drawer on bottom. **Includes one 3-position fixed/height adjustable shelf.** Lock secures one file drawer. 36" and 30" wide models have front-to-back and side-to-side letter/legal filing capability. Side-to-side file bars included.

- Lateral file drawer construction is for accommodating hanging files NOT for stacking materials on the drawer bottom.

Required Specifications

Top finish
Top/edge detail
Handles
Base finish

Optional Specifications

Glazed doors*
HP laminate
Box drawer - no upcharge
Collator**

STORAGE MODULES - 40.8" / 41.3" HIGH

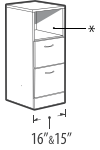
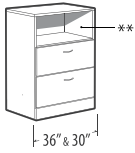

* Accepts collator 11" high
 ** Accepts collator 11.3" high

Two File Module with Open Shelf*

MODEL#	DIMENSIONS D x W x H	FREIGHT CLASS	WT/LBS.	CUBIC FT.	1" TOP	1.5" TOP	GLAZE ADD	HP ADD
Z36L4EN	24 x 36 x 41.3-41.8	125	199.50	25	\$1523	\$1580	N/A	\$145
Z30L4EN	24 x 30 x 41.3-41.8	100	178.50	21.25	\$1454	\$1503	N/A	\$121
Z16L4EN	24 x 16 x 41.3-41.8	100	116.55	12	\$913	\$947	N/A	\$74
Z15L4EN	24 x 15 x 41.3-41.8	100	112.35	11.25	\$888	\$916	N/A	\$74
Z36M4EN	20 x 36 x 41.3-41.8	100	182	21.25	\$1452	\$1502	N/A	\$145
Z30M4EN	20 x 30 x 41.3-41.8	100	163	18	\$1377	\$1419	N/A	\$121
Z16M4EN	20 x 16 x 41.3-41.8	92.5	105	10.25	\$840	\$869	N/A	\$74
Z15M4EN	20 x 15 x 41.3-41.8	92.5	101	9.50	\$817	\$840	N/A	\$74
Z36S4EN	16 x 36 x 41.3-41.8	100	153.30	17.50	\$1331	\$1380	N/A	\$109
Z30S4EN	16 x 30 x 41.3-41.8	100	131.25	14.50	\$1212	\$1245	N/A	\$97
Z16S4EN	16 x 16 x 41.3-41.8	92.5	85.05	8.50	\$771	\$799	N/A	\$61
Z15S4EN	16 x 15 x 41.3-41.8	92.5	82.95	8	\$751	\$773	N/A	\$61

Open fixed shelf and two file drawers on bottom. Lock secures all drawers. 36" and 30" wide models have front-to-back and side-to-side letter/legal filing capability. Side-to-side file bars included.

- Lateral file drawer construction is for accommodating hanging files NOT for stacking materials on the drawer bottom.



Three File Module

Z36L43F	24 x 36 x 41.3-41.8	100	210	25	\$1790	\$1847	N/A	\$145
Z30L43F	24 x 30 x 41.3-41.8	100	190.05	21.25	\$1700	\$1750	N/A	\$121
Z16L43F	24 x 16 x 41.3-41.8	92.5	126	12	\$1051	\$1084	N/A	\$61
Z15L43F	24 x 15 x 41.3-41.8	92.5	120.75	11.25	\$1022	\$1050	N/A	\$61
Z36M43F	20 x 36 x 41.3-41.8	100	198.45	21.25	\$1742	\$1792	N/A	\$145
Z30M43F	20 x 30 x 41.3-41.8	100	177.45	18	\$1626	\$1669	N/A	\$121
Z16M43F	20 x 16 x 41.3-41.8	92.5	114.45	10.25	\$980	\$1009	N/A	\$61
Z15M43F	20 x 15 x 41.3-41.8	92.5	110.25	9.50	\$955	\$978	N/A	\$61
Z36S43F	16 x 36 x 41.3-41.8	100	165.90	17.50	\$1572	\$1621	N/A	\$109
Z30S43F	16 x 30 x 41.3-41.8	92.5	148.05	14.50	\$1448	\$1482	N/A	\$97
Z16S43F	16 x 16 x 41.3-41.8	92.5	94.50	8.50	\$927	\$955	N/A	\$61
Z15S43F	16 x 15 x 41.3-41.8	92.5	91.35	8	\$896	\$919	N/A	\$61

Three file drawers. Lock secures all drawers. 36" and 30" wide models have front-to-back and side-to-side letter/legal filing capability. Side-to-side file bars included.

- Lateral file drawer construction is for accommodating hanging files NOT for stacking materials on the drawer bottom.



Three File Module

Z36L4S3F	24 x 36 x 41.3-41.8	100	233	25	\$2116	\$2173	N/A	\$145
Z36M4S3F	20 x 36 x 41.3-41.8	92.5	221	21.25	\$2046	\$2097	N/A	\$121

Three lateral file drawers with steel drawer interior. Lock secures all drawers. Front-to-back and side-to-side letter/legal filing capability. Side-to-side file bars included.

- Front-to-back filing bars available separately. Order **FBB** bars. See "FBB" on page 33.
- Lateral file drawer construction is for accommodating hanging files NOT for stacking materials on the drawer bottom.
- To prevent overloading, steel drawers do not include a back panel

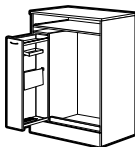

Media Center - LEFT

Z36L4MCL	24 x 36 x 41.3-41.8	100	206.85	25	\$1630	\$1687	N/A	\$145
Z30L4MCL	24 x 30 x 41.3-41.8	100	185.85	21.25	\$1536	\$1586	N/A	\$121
Z36M4MCL	20 x 36 x 41.3-41.8	100	172.20	21.25	\$1425	\$1475	N/A	\$145
Z30M4MCL	20 x 30 x 41.3-41.8	100	153.30	18	\$1330	\$1373	N/A	\$121
Z36S4MCL	16 x 36 x 41.3-41.8	100	172	17.50	\$1366	\$1416	N/A	\$109
Z30S4MCL	16 x 30 x 41.3-41.8	92.5	153	14.50	\$1249	\$1283	N/A	\$97

Standing height unit, accommodates pc, keyboard, monitor, hanging folders and accessories and/or printer. One vertical drawer on the **left**. Pull out keyboard shelf. Adjustable pull out bottom shelf accommodates pc and/or printer. Grommet in worksurface and back panel. Lock secures vertical drawer.

Required Specifications

- Top finish
- Top/edge detail
- Handles
- Base finish

Optional Specifications

- HP laminate
- Box drawer - no upcharge (not available on units with steel drawers)
- Collator*

STORAGE MODULES - 40.8" / 41.3" HIGH

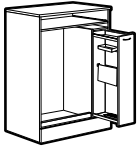

Media Center - RIGHT

MODEL#	DIMENSIONS D x W x H	FREIGHT CLASS	WT/LBS.	CUBIC FT.	1" TOP	1.5" TOP	GLAZE ADD	HP ADD
Z36L4MCR	24 x 36 x 41.3-41.8	100	206.85	25	\$1630	\$1687	N/A	\$145
Z30L4MCR	24 x 30 x 41.3-41.8	100	185.85	21.25	\$1536	\$1586	N/A	\$121
Z36M4MCR	20 x 36 x 41.3-41.8	100	172.20	21.25	\$1425	\$1475	N/A	\$145
Z30M4MCR	20 x 30 x 41.3-41.8	100	153.30	18	\$1330	\$1373	N/A	\$121
Z36S4MCR	16 x 36 x 41.3-41.8	100	172	17.50	\$1366	\$1416	N/A	\$109
Z30S4MCR	16 x 30 x 41.3-41.8	92.5	153	14.50	\$1249	\$1283	N/A	\$97

Standing height unit, accommodates pc, keyboard, monitor, hanging folders and accessories and/or printer. One vertical drawer on the **right**. Pull out keyboard shelf. Adjustable pull out bottom shelf accommodates pc and/or printer. Grommet in worksurface and back panel. Lock secures vertical drawer.

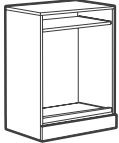

PC Center

Z36L4PC	24 x 36 x 41.3-41.8	125	169.05	25	\$1046	\$1104	N/A	\$145
Z30L4PC	24 x 30 x 41.3-41.8	125	147	21.25	\$949	\$999	N/A	\$121
Z36M4PC	20 x 36 x 41.3-41.8	125	152.25	21.25	\$992	\$1042	N/A	\$145
Z30M4PC	20 x 30 x 41.3-41.8	125	132.30	18	\$879	\$922	N/A	\$121
Z36S4PC	16 x 36 x 41.3-41.8	100	150	17.50	\$880	\$929	N/A	\$109
Z30S4PC	16 x 30 x 41.3-41.8	100	129	14.50	\$763	\$796	N/A	\$97

Standing height unit, accommodates pc, keyboard, monitor and/or printer. Pull out keyboard shelf. Adjustable pull out bottom shelf accommodates pc and/or printer. Grommet in worksurface and back panel.

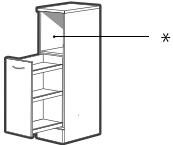

Vertical Utility Drawer - LEFT*

Z12L4VDNL	24 x 12 x 41.3-41.8	85	117.60	9.25	\$862	\$887	N/A	\$50
Z12M4VDNL	20 x 12 x 41.3-41.8	85	98.70	8	\$763	\$783	N/A	\$50
Z12S4VDNL	16 x 12 x 41.3-41.8	85	82.95	6.50	\$666	\$686	N/A	\$50

One vertical drawer. Lock secures vertical drawer.

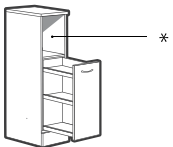

Vertical Utility Drawer - RIGHT*

Z12L4VDNR	24 x 12 x 41.3-41.8	85	117.60	9.25	\$862	\$887	N/A	\$50
Z12M4VDNR	20 x 12 x 41.3-41.8	85	98.70	8	\$763	\$783	N/A	\$50
Z12S4VDNR	16 x 12 x 41.3-41.8	85	82.95	6.50	\$666	\$686	N/A	\$50

One vertical drawer. Lock secures vertical drawer.

STORAGE MODULES - 52.5" / 53" HIGH

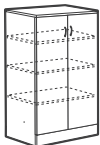

Storage Cabinet with Doors**

MODEL#	DIMENSIONS	FREIGHT CLASS	WT/LBS.	CUBIC FT.	1" TOP	1.5" TOP	GLAZE ADD	HP ADD
Z36L5SH	24 x 36 x 53-53.5	125	229.95	31.25	\$1442	\$1499	\$936	\$145
Z30L5SH	24 x 30 x 53-53.5	125	199.50	27	\$1314	\$1364	\$813	\$121
Z36M5SH	20 x 36 x 53-53.5	125	203.70	27	\$1344	\$1394	\$936	\$145
Z30M5SH	20 x 30 x 53-53.5	100	184.80	22.75	\$1179	\$1221	\$813	\$121
Z36S5SH	16 x 36 x 53-53.5	100	175.35	21.75	\$1259	\$1308	\$936	\$109
Z30S5SH	16 x 30 x 53-53.5	100	152.25	18.50	\$1103	\$1136	\$813	\$97

Laminate doors are standard. **Includes three 3-position fixed/height adjustable shelves.** Standard with lock.

Required Specifications

Top finish
Top/edge detail
Handles
Base finish

Optional Specifications

HP laminate
Collator*
Glazed doors**

STORAGE MODULES - 52.5" / 53" HIGH

MODEL# DIMENSIONS FREIGHT CLASS WT/LBS. CUBIC FT. 1" TOP 1.5" TOP GLAZE ADD HP ADD

D x W x H

Z21L5SHL	24 x 21 x 53-53.5	125	154.35	19.50	\$1038	\$1079	\$518	\$97
Z18L5SHL	24 x 18 x 53-53.5	100	139.65	17	\$989	\$1023	\$465	\$74
Z16L5SHL	24 x 16 x 53-53.5	100	130.20	15.50	\$936	\$970	\$460	\$74
Z15L5SHL	24 x 15 x 53-53.5	100	124.95	14.25	\$892	\$920	\$404	\$74
Z12L5SHL	24 x 12 x 53-53.5	100	110.25	11.75	\$832	\$855	\$364	\$50
Z21M5SHL	20 x 21 x 53-53.5	100	142.80	16.50	\$949	\$983	\$518	\$97
Z18M5SHL	20 x 18 x 53-53.5	100	122.85	14.25	\$900	\$930	\$465	\$74
Z16M5SHL	20 x 16 x 53-53.5	100	113.40	13	\$853	\$882	\$460	\$74
Z15M5SHL	20 x 15 x 53-53.5	100	109.20	12.25	\$809	\$834	\$404	\$74
Z12M5SHL	20 x 12 x 53-53.5	100	96.60	10	\$750	\$771	\$364	\$50
Z21S5SHL	16 x 21 x 53-53.5	100	116.55	13.25	\$883	\$910	\$518	\$74
Z18S5SHL	16 x 18 x 53-53.5	100	103.95	11.50	\$840	\$868	\$465	\$61
Z16S5SHL	16 x 16 x 53-53.5	100	96.60	10.50	\$796	\$824	\$460	\$61
Z15S5SHL	16 x 15 x 53-53.5	100	91.35	9.75	\$765	\$787	\$404	\$61
Z12S5SHL	16 x 12 x 53-53.5	100	79.80	8.25	\$703	\$723	\$364	\$50

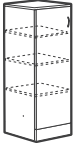

Glazed door option

Storage Cabinet with Door - LEFT**

Laminate doors are standard. Includes three 3-position fixed/height adjustable shelves. Standard with lock.

Z21L5SHR	24 x 21 x 53-53.5	125	154.35	19.50	\$1038	\$1079	\$518	\$97
Z18L5SHR	24 x 18 x 53-53.5	100	139.65	17	\$989	\$1023	\$465	\$74
Z16L5SHR	24 x 16 x 53-53.5	100	130.20	15.50	\$936	\$970	\$460	\$74
Z15L5SHR	24 x 15 x 53-53.5	100	124.95	14.25	\$892	\$920	\$404	\$74
Z12L5SHR	24 x 12 x 53-53.5	100	110.25	11.75	\$832	\$855	\$364	\$50
Z21M5SHR	20 x 21 x 53-53.5	100	142.80	16.50	\$949	\$983	\$518	\$97
Z18M5SHR	20 x 18 x 53-53.5	100	122.85	14.25	\$900	\$930	\$465	\$74
Z16M5SHR	20 x 16 x 53-53.5	100	113.40	13	\$853	\$882	\$460	\$74
Z15M5SHR	20 x 15 x 53-53.5	100	109.20	12.25	\$809	\$834	\$404	\$74
Z12M5SHR	20 x 12 x 53-53.5	100	96.60	10	\$750	\$771	\$364	\$50
Z21S5SHR	16 x 21 x 53-53.5	100	116.55	13.25	\$883	\$910	\$518	\$74
Z18S5SHR	16 x 18 x 53-53.5	100	103.95	11.50	\$840	\$868	\$465	\$61
Z16S5SHR	16 x 16 x 53-53.5	100	96.60	10.50	\$796	\$824	\$460	\$61
Z15S5SHR	16 x 15 x 53-53.5	100	91.35	9.75	\$765	\$787	\$404	\$61
Z12S5SHR	16 x 12 x 53-53.5	100	79.80	8.25	\$703	\$723	\$364	\$50

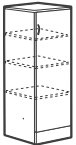

Glazed door option

Storage Cabinet with Door - RIGHT**

Laminate doors are standard. Includes three 3-position fixed/height adjustable shelves. Standard with lock.

Z36L5SHN	24 x 36 x 53-53.5	125	198.49	31.25	\$1122	\$1180	N/A	\$145
Z30L5SHN	24 x 30 x 53-53.5	125	173.45	27	\$1048	\$1098	N/A	\$121
Z21L5SHN	24 x 21 x 53-53.5	125	136.43	19.50	\$862	\$903	N/A	\$97
Z18L5SHN	24 x 18 x 53-53.5	125	124.44	17	\$828	\$862	N/A	\$74
Z16L5SHN	24 x 16 x 53-53.5	125	116.10	15.50	\$774	\$807	N/A	\$74
Z15L5SHN	24 x 15 x 53-53.5	125	112.45	14.25	\$748	\$776	N/A	\$74
Z12L5SHN	24 x 12 x 53-53.5	100	100.46	11.75	\$699	\$722	N/A	\$50
Z36M5SHN	20 x 36 x 53-53.5	125	172.27	27	\$1021	\$1072	N/A	\$145
Z30M5SHN	20 x 30 x 53-53.5	125	158.08	22.75	\$913	\$956	N/A	\$121
Z21M5SHN	20 x 21 x 53-53.5	125	123.68	16.50	\$771	\$805	N/A	\$97
Z18M5SHN	20 x 18 x 53-53.5	125	106.61	14.25	\$736	\$766	N/A	\$74
Z16M5SHN	20 x 16 x 53-53.5	125	99.43	13	\$689	\$718	N/A	\$74
Z15M5SHN	20 x 15 x 53-53.5	125	95.84	12.25	\$664	\$689	N/A	\$74
Z12M5SHN	20 x 12 x 53-53.5	100	85.07	10	\$617	\$638	N/A	\$50
Z36S5SHN	16 x 36 x 53-53.5	125	145.01	21.75	\$891	\$940	N/A	\$109
Z30S5SHN	16 x 30 x 53-53.5	125	126.96	18.50	\$803	\$836	N/A	\$97
Z21S5SHN	16 x 21 x 53-53.5	125	98.33	13.25	\$677	\$705	N/A	\$74
Z18S5SHN	16 x 18 x 53-53.5	125	88.78	11.50	\$649	\$678	N/A	\$61
Z16S5SHN	16 x 16 x 53-53.5	125	82.76	10.50	\$606	\$634	N/A	\$61
Z15S5SHN	16 x 15 x 53-53.5	100	78.18	9.75	\$597	\$619	N/A	\$61
Z12S5SHN	16 x 12 x 53-53.5	100	69.69	8.25	\$552	\$572	N/A	\$50

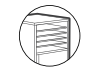
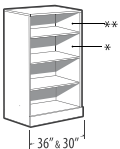

* Accepts collator 11" high
** Accepts collator 11.3" high

Open Storage Cabinet*

Includes three 3-position fixed/height adjustable shelves

Required Specifications

- Top finish
- Top/edge detail
- Handles
- Base finish

Optional Specifications

- HP laminate
- Collator*
- Glazed doors**

STORAGE MODULES - 52.5" / 53" HIGH

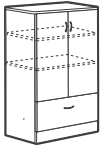

Glazed door option

File Module with Doors**

MODEL#	DIMENSIONS D x W x H	FREIGHT CLASS	WT./LBS.	CUBIC FT.	1" TOP	1.5" TOP	GLAZE ADD	HP ADD
Z36L5F	24 x 36 x 53-53.5	125	247.80	31.25	\$1727	\$1785	\$763	\$145
Z30L5F	24 x 30 x 53-53.5	100	216.30	27	\$1622	\$1672	\$666	\$121
Z36M5F	20 x 36 x 53-53.5	100	221.55	27	\$1626	\$1676	\$763	\$145
Z30M5F	20 x 30 x 53-53.5	100	204.75	22.75	\$1486	\$1529	\$666	\$121
Z36S5F	16 x 36 x 53-53.5	100	189	21.75	\$1474	\$1524	\$763	\$109
Z30S5F	16 x 30 x 53-53.5	100	163.80	18.50	\$1312	\$1345	\$666	\$97

One lateral file drawer. Laminate doors are standard. **Includes two 3-position fixed/height adjustable shelves.** Upper lock secures storage compartment. Lower lock secures one file drawer. Front-to-back and side-to-side letter/legal filing capability. Side-to-side file bars included.

- Lateral file drawer construction is for accommodating hanging files NOT for stacking materials on the drawer bottom.

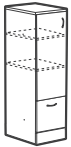

Glazed door option

File Module with Door - LEFT**

Z16L5FL	24 x 16 x 53-53.5	100	140.70	15.50	\$1068	\$1102	\$392	\$74
Z15L5FL	24 x 15 x 53-53.5	100	134.40	14.25	\$1023	\$1051	\$342	\$74
Z16M5FL	20 x 16 x 53-53.5	100	123.90	13	\$983	\$1012	\$370	\$74
Z15M5FL	20 x 15 x 53-53.5	100	119.70	12.25	\$941	\$964	\$342	\$74
Z16S5FL	16 x 16 x 53-53.5	92.5	105	10.50	\$898	\$926	\$370	\$61
Z15S5FL	16 x 15 x 53-53.5	92.5	99.75	9.75	\$876	\$899	\$342	\$61

One file drawer. Laminate door is standard. **Includes two 3-position fixed/height adjustable shelves.** Upper lock secures storage compartment. Lower lock secures one file drawer.

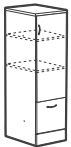

Glazed door option

File Module with Door - RIGHT**

Z16L5FR	24 x 16 x 53-53.5	100	140.70	15.50	\$1068	\$1102	\$392	\$74
Z15L5FR	24 x 15 x 53-53.5	100	134.40	14.25	\$1023	\$1051	\$342	\$74
Z16M5FR	20 x 16 x 53-53.5	100	123.90	13	\$983	\$1012	\$370	\$74
Z15M5FR	20 x 15 x 53-53.5	100	119.70	12.25	\$941	\$964	\$342	\$74
Z16S5FR	16 x 16 x 53-53.5	92.5	105	10.50	\$898	\$926	\$370	\$61
Z15S5FR	16 x 15 x 53-53.5	92.5	99.75	9.75	\$876	\$899	\$342	\$61

One file drawer. Laminate door is standard. **Includes two 3-position fixed/height adjustable shelves.** Upper lock secures storage compartment. Lower lock secures one file drawer.

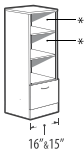
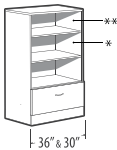

* Accepts collator 11" high
** Accepts collator 11.3" high

File Module with Open Shelves*

Z36L5FN	24 x 36 x 53-53.5	125	224.32	31.25	\$1462	\$1520	N/A	\$145
Z30L5FN	24 x 30 x 53-53.5	125	196.91	27	\$1395	\$1445	N/A	\$121
Z16L5FN	24 x 16 x 53-53.5	100	130.15	15.50	\$939	\$972	N/A	\$74
Z15L5FN	24 x 15 x 53-53.5	100	125.23	14.25	\$907	\$935	N/A	\$74
Z36M5FN	20 x 36 x 53-53.5	125	197.05	27	\$1362	\$1412	N/A	\$145
Z30M5FN	20 x 30 x 53-53.5	125	174.19	22.75	\$1260	\$1302	N/A	\$121
Z16M5FN	20 x 16 x 53-53.5	100	113.48	13	\$854	\$883	N/A	\$74
Z15M5FN	20 x 15 x 53-53.5	100	109.67	12.25	\$823	\$846	N/A	\$74
Z36S5FN	16 x 36 x 53-53.5	125	166.64	21.75	\$1210	\$1260	N/A	\$109
Z30S5FN	16 x 30 x 53-53.5	125	145.17	18.50	\$1084	\$1117	N/A	\$97
Z16S5FN	16 x 16 x 53-53.5	100	94.71	10.50	\$768	\$796	N/A	\$61
Z15S5FN	16 x 15 x 53-53.5	100	89.91	9.75	\$759	\$782	N/A	\$61

Three open shelves and one file drawer on bottom. **Includes two 3-position fixed/height adjustable shelves.** Lock secures file drawer. 36" and 30" wide models have front-to-back and side-to-side letter/legal filing capability. Side-to-side file bars included

- Lateral file drawer construction is for accommodating hanging files NOT for stacking materials on the drawer bottom.

Required Specifications

Top finish
Top/edge detail
Handles
Base finish

Optional Specifications

HP laminate
Collator*
Glazed doors**
Box drawer - no upcharge*

STORAGE MODULES - 52.5" / 53" HIGH

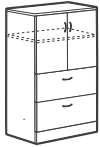

Glazed door option

Two File Module with Doors

MODEL#	DIMENSIONS D x W x H	FREIGHT CLASS	WT/LBS.	CUBIC FT.	1" TOP	1.5" TOP	GLAZE ADD	HP ADD
Z36L5E	24 x 36 x 53-53.5	100	250.95	31.25	\$1957	\$2015	\$572	\$145
Z30L5E	24 x 30 x 53-53.5	100	222.60	27	\$1825	\$1875	\$502	\$121
Z36M5E	20 x 36 x 53-53.5	100	229.95	27	\$1867	\$1918	\$595	\$145
Z30M5E	20 x 30 x 53-53.5	100	201.60	22.75	\$1700	\$1743	\$525	\$121
Z36S5E	16 x 36 x 53-53.5	100	193.20	21.75	\$1647	\$1696	\$595	\$109
Z30S5E	16 x 30 x 53-53.5	100	170.10	18.50	\$1515	\$1548	\$525	\$97

Two lateral file drawers on bottom. Laminate doors are standard. **Includes one 3-position fixed/height adjustable shelf.** Upper lock secures storage compartment. Lower lock secures two file drawers. Front-to-back and side-to-side letter/legal filing capability. Side-to-side file bars included.

- Lateral file drawer construction is for accommodating hanging files NOT for stacking materials on the drawer bottom.

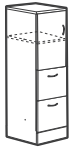

Glazed door option

Two File Module with Door - LEFT

Z16L5EL	24 x 16 x 53-53.5	100	144.90	15.50	\$1137	\$1170	\$290	\$74
Z15L5EL	24 x 15 x 53-53.5	100	139.65	14.25	\$1094	\$1122	\$260	\$74
Z16M5EL	20 x 16 x 53-53.5	92.5	130.20	13	\$1056	\$1085	\$289	\$74
Z15M5EL	20 x 15 x 53-53.5	92.5	126	12.25	\$1015	\$1040	\$260	\$74
Z16S5EL	16 x 16 x 53-53.5	92.5	109.20	10.50	\$969	\$997	\$289	\$61
Z15S5EL	16 x 15 x 53-53.5	92.5	105	9.75	\$951	\$974	\$260	\$61

Two file drawers on bottom. Laminate door is standard. **Includes one 3-position fixed/height adjustable shelf.** Upper lock secures storage compartment. Lower lock secures two file drawers.

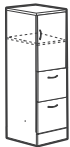

Glazed door option

Two File Module with Door - RIGHT

Z16L5ER	24 x 16 x 53-53.5	100	144.90	15.50	\$1137	\$1170	\$290	\$74
Z15L5ER	24 x 15 x 53-53.5	100	139.65	14.25	\$1094	\$1122	\$260	\$74
Z16M5ER	20 x 16 x 53-53.5	92.5	130.20	13	\$1056	\$1085	\$289	\$74
Z15M5ER	20 x 15 x 53-53.5	92.5	126	12.25	\$1015	\$1040	\$260	\$74
Z16S5ER	16 x 16 x 53-53.5	92.5	109.20	10.50	\$969	\$997	\$289	\$61
Z15S5ER	16 x 15 x 53-53.5	92.5	105	9.75	\$951	\$974	\$260	\$61

Two file drawers on bottom. Laminate door is standard. **Includes one 3-position fixed/height adjustable shelf.** Upper lock secures storage compartment. Lower lock secures two file drawers.

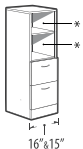
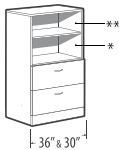

* Accepts collator 11" high
** Accepts collator 11.3" high

Two File Module with Open Shelves

Z36L5EN	24 x 36 x 53-53.5	125	235.45	31.25	\$1747	\$1805	N/A	\$145
Z30L5EN	24 x 30 x 53-53.5	125	209.86	27	\$1636	\$1685	N/A	\$121
Z16L5EN	24 x 16 x 53-53.5	100	137.89	15.50	\$1030	\$1063	N/A	\$74
Z15L5EN	24 x 15 x 53-53.5	100	133.80	14.25	\$998	\$1026	N/A	\$74
Z36M5EN	20 x 36 x 53-53.5	125	213.43	27	\$1659	\$1709	N/A	\$145
Z30M5EN	20 x 30 x 53-53.5	100	188.19	22.75	\$1509	\$1552	N/A	\$121
Z16M5EN	20 x 16 x 53-53.5	100	123.33	13	\$949	\$978	N/A	\$74
Z15M5EN	20 x 15 x 53-53.5	100	119.29	12.25	\$917	\$940	N/A	\$74
Z36S5EN	16 x 36 x 53-53.5	100	178.82	21.75	\$1437	\$1486	N/A	\$109
Z30S5EN	16 x 30 x 53-53.5	100	158.12	18.50	\$1325	\$1358	N/A	\$97
Z16S5EN	16 x 16 x 53-53.5	100	102.46	10.50	\$862	\$890	N/A	\$61
Z15S5EN	16 x 15 x 53-53.5	92.5	98.48	9.75	\$855	\$877	N/A	\$61

Two open shelves and two file drawers on bottom. **Includes one 3-position fixed/height adjustable shelf.** Lock secures all drawers. 36" and 30" wide models have front-to-back and side-to-side letter/legal filing capability. Side-to-side file bars included.

- Lateral file drawer construction is for accommodating hanging files NOT for stacking materials on the drawer bottom.

Required Specifications

Top finish
Top/edge detail
Handles
Base finish

Optional Specifications

HP laminate
Collator*
Glazed doors**
Box drawer - no upcharge*

STORAGE MODULES - 52.5" / 53" HIGH

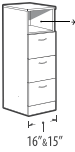
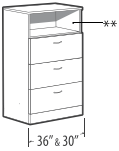

* Accepts collator 11" high
** Accepts collator 11.3" high

Three File Module with Open Shelf*

MODEL#	DIMENSIONS D x W x H	FREIGHT CLASS	WT./LBS.	CUBIC FT.	1" TOP	1.5" TOP	GLAZE ADD	HP ADD
Z36L53FN	24 x 36 x 53-53.5	125	247.80	31.25	\$1980	\$2038	N/A	\$145
Z30L53FN	24 x 30 x 53-53.5	100	221.55	27	\$1876	\$1926	N/A	\$121
Z16L53FN	24 x 16 x 53-53.5	100	147	15.50	\$1165	\$1198	N/A	\$74
Z15L53FN	24 x 15 x 53-53.5	100	140.70	14.25	\$1131	\$1159	N/A	\$74
Z36M53FN	20 x 36 x 53-53.5	100	227.85	27	\$1903	\$1953	N/A	\$145
Z30M53FN	20 x 30 x 53-53.5	100	203.70	22.75	\$1759	\$1801	N/A	\$121
Z16M53FN	20 x 16 x 53-53.5	92.5	132.30	13	\$1089	\$1118	N/A	\$74
Z15M53FN	20 x 15 x 53-53.5	92.5	128.10	12.25	\$1057	\$1080	N/A	\$74
Z36S53FN	16 x 36 x 53-53.5	100	190.05	21.75	\$1686	\$1735	N/A	\$109
Z30S53FN	16 x 30 x 53-53.5	100	166.95	18.50	\$1535	\$1568	N/A	\$97
Z16S53FN	16 x 16 x 53-53.5	92.5	112.35	10.50	\$1000	\$1028	N/A	\$61
Z15S53FN	16 x 15 x 53-53.5	92.5	107.10	9.75	\$989	\$1011	N/A	\$61

Fixed open shelf and three file drawers. Lock secures all drawers. 36" and 30" wide models have front-to-back and side-to-side letter/legal filing capability. Side-to-side file bars included.

- Lateral file drawer construction is for accommodating hanging files NOT for stacking materials on the drawer bottom.



Four File Module

Z36L54F	24 x 36 x 53-53.5	100	256.20	31.25	\$2207	\$2264	N/A	\$145
Z30L54F	24 x 30 x 53-53.5	100	234.15	27	\$2116	\$2166	N/A	\$121
Z16L54F	24 x 16 x 53-53.5	92.5	155.40	15.50	\$1266	\$1299	N/A	\$74
Z15L54F	24 x 15 x 53-53.5	92.5	148.05	14.25	\$1223	\$1251	N/A	\$74
Z36M54F	20 x 36 x 53-53.5	100	239.40	27	\$2139	\$2189	N/A	\$145
Z30M54F	20 x 30 x 53-53.5	100	218.40	22.75	\$2009	\$2052	N/A	\$121
Z16M54F	20 x 16 x 53-53.5	92.5	141.75	13	\$1195	\$1224	N/A	\$74
Z15M54F	20 x 15 x 53-53.5	92.5	136.50	12.25	\$1154	\$1177	N/A	\$74
Z36S54F	16 x 36 x 53-53.5	100	205	21.75	\$1913	\$1962	N/A	\$109
Z30S54F	16 x 30 x 53-53.5	100	180	18.50	\$1744	\$1777	N/A	\$97
Z16S54F	16 x 16 x 53-53.5	92.5	122	10.50	\$1175	\$1203	N/A	\$61
Z15S54F	16 x 15 x 53-53.5	92.5	116	9.75	\$1131	\$1154	N/A	\$61

Four file drawers. Lock secures all drawers. 36" and 30" wide models have front-to-back and side-to-side letter/legal filing capability. Side-to-side file bars included.

- Lateral file drawer construction is for accommodating hanging files NOT for stacking materials on the drawer bottom.



Four File Module

Z36L5S4F	24 x 36 x 53-53.5	100	286	31.25	\$2639	\$2696	N/A	\$145
Z36M5S4F	20 x 36 x 53-53.5	100	269	27	\$2561	\$2612	N/A	\$145

Four file drawers with steel drawer interior. Lock secures all drawers. Front-to-back and side-to-side letter/legal filing capability. Side-to-side file bars included.

- Front-to-back filing bars available separately. Order **FBB** bars. See "FBB" on page 33.
- Lateral file drawer construction is for accommodating hanging files NOT for stacking materials on the drawer bottom.
- To prevent overloading, steel drawers do not include a back panel

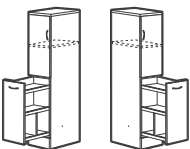

Vertical Utility Drawer with Door**

Z12L5VDL	24 x 12 x 53-53.5	92.5	137.55	11.75	\$1007	\$1032	\$235	\$50
Z12M5VDL	20 x 12 x 53-53.5	92.5	118.65	10	\$905	\$925	\$235	\$50
Z12S5VDL	16 x 12 x 53-53.5	85	100	8.25	\$817	\$837	\$235	\$50
Z12L5VDR	24 x 12 x 53-53.5	92.5	137.55	11.75	\$1007	\$1032	\$235	\$50
Z12M5VDR	20 x 12 x 53-53.5	92.5	118.65	10	\$905	\$925	\$235	\$50
Z12S5VDR	16 x 12 x 53-53.5	85	100	8.25	\$817	\$837	\$235	\$50

Specify **VDL** models for **LEFT** or **VDR** models for **RIGHT**

Laminate doors are standard. Includes one 3-position fixed/height adjustable shelf and one vertical drawer. Upper lock secures storage compartment. Lower lock secures vertical drawer.

Required Specifications

- Top finish
- Top/edge detail
- Handles
- Base finish

Optional Specifications

- HP laminate
- Collator*
- Glazed doors**
- Box drawer - no upcharge*

STORAGE MODULES - 65" / 65.5" HIGH

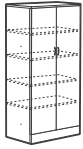

Glazed door option

Storage Cabinet with Doors**

MODEL#	DIMENSIONS	FREIGHT CLASS	WT/LBS.	CUBIC FT.	1" TOP	1.5" TOP	GLAZE ADD	HP ADD	
D x W x H									
Z36L6SH	24 x 36 x 65.5-66	125	273	39	\$1709	\$1767	\$1109	N/A	
Z30L6SH	24 x 30 x 65.5-66	125	238.35	32.75	\$1493	\$1543	\$959	N/A	
Z36M6SH	20 x 36 x 65.5-66	125	246.75	33.25	\$1585	\$1636	\$1109	N/A	
Z30M6SH	20 x 30 x 65.5-66	125	212.10	27.75	\$1383	\$1425	\$959	N/A	
Z36S6SH	16 x 36 x 65.5-66	125	210	26.50	\$1435	\$1484	\$1109	N/A	
Z30S6SH	16 x 30 x 65.5-66	100	183.75	22.50	\$1233	\$1267	\$959	N/A	

Laminate doors are standard. **Includes four 3-position fixed/height adjustable shelves.** Standard with lock.

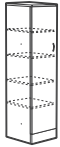

Glazed door option

Storage Cabinet with Door - LEFT**

Z21L6SHL	24 x 21 x 65.5-66	125	185.85	23.50	\$1224	\$1265	\$614	N/A
Z18L6SHL	24 x 18 x 65.5-66	100	168	20.50	\$1144	\$1178	\$552	N/A
Z16L6SHL	24 x 16 x 65.5-66	100	156.45	18.75	\$1077	\$1110	\$546	N/A
Z15L6SHL	24 x 15 x 65.5-66	100	149.10	17.50	\$1045	\$1073	\$477	N/A
Z12L6SHL	24 x 12 x 65.5-66	100	133.35	14.50	\$948	\$973	\$429	N/A
Z21M6SHL	20 x 21 x 65.5-66	100	170.10	20	\$1095	\$1129	\$614	N/A
Z18M6SHL	20 x 18 x 65.5-66	100	148.05	17.25	\$1045	\$1074	\$552	N/A
Z16M6SHL	20 x 16 x 65.5-66	100	137.55	15.75	\$983	\$1012	\$546	N/A
Z15M6SHL	20 x 15 x 65.5-66	100	133.35	14.75	\$937	\$962	\$477	N/A
Z12M6SHL	20 x 12 x 65.5-66	100	116.55	12.25	\$868	\$889	\$429	N/A
Z21S6SHL	16 x 21 x 65.5-66	100	140.70	16	\$1010	\$1037	\$614	N/A
Z18S6SHL	16 x 18 x 65.5-66	100	126	14	\$935	\$963	\$552	N/A
Z16S6SHL	16 x 16 x 65.5-66	100	116.55	13	\$879	\$907	\$546	N/A
Z15S6SHL	16 x 15 x 65.5-66	100	111.30	12	\$835	\$858	\$477	N/A
Z12S6SHL	16 x 12 x 65.5-66	100	96.60	10	\$766	\$786	\$429	N/A

Laminate doors are standard. **Includes four 3-position fixed/height adjustable shelves.** Standard with lock.

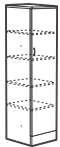

Glazed door option

Storage Cabinet with Door - RIGHT**

Z21L6SHR	24 x 21 x 65.5-66	125	185.85	23.50	\$1224	\$1265	\$614	N/A
Z18L6SHR	24 x 18 x 65.5-66	100	168	20.50	\$1144	\$1178	\$552	N/A
Z16L6SHR	24 x 16 x 65.5-66	100	156.45	18.75	\$1077	\$1110	\$546	N/A
Z15L6SHR	24 x 15 x 65.5-66	100	149.10	17.50	\$1045	\$1073	\$477	N/A
Z12L6SHR	24 x 12 x 65.5-66	100	133.35	14.50	\$948	\$973	\$429	N/A
Z21M6SHR	20 x 21 x 65.5-66	100	170.10	20	\$1095	\$1129	\$614	N/A
Z18M6SHR	20 x 18 x 65.5-66	100	148.05	17.25	\$1045	\$1074	\$552	N/A
Z16M6SHR	20 x 16 x 65.5-66	100	137.55	15.75	\$983	\$1012	\$546	N/A
Z15M6SHR	20 x 15 x 65.5-66	100	133.35	14.75	\$937	\$962	\$477	N/A
Z12M6SHR	20 x 12 x 65.5-66	100	116.55	12.25	\$868	\$889	\$429	N/A
Z21S6SHR	16 x 21 x 65.5-66	100	140.70	16	\$1010	\$1037	\$614	N/A
Z18S6SHR	16 x 18 x 65.5-66	100	126	14	\$935	\$963	\$552	N/A
Z16S6SHR	16 x 16 x 65.5-66	100	116.55	13	\$879	\$907	\$546	N/A
Z15S6SHR	16 x 15 x 65.5-66	100	111.30	12	\$835	\$858	\$477	N/A
Z12S6SHR	16 x 12 x 65.5-66	100	96.60	10	\$766	\$786	\$429	N/A

Laminate doors are standard. **Includes four 3-position fixed/height adjustable shelves.** Standard with lock.

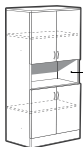

* Accepts collator 11" high

Storage Cabinet with Doors and Cavity*

Z36L6SHC	24 x 36 x 65.5-66	125	266.90	39	\$1760	\$1817	\$1268	N/A
Z30L6SHC	24 x 30 x 65.5-66	125	232.57	32.75	\$1569	\$1619	\$1112	N/A
Z36M6SHC	20 x 36 x 65.5-66	125	238.59	33.25	\$1636	\$1686	\$1268	N/A
Z30M6SHC	20 x 30 x 65.5-66	125	205.65	27.75	\$1459	\$1501	\$1112	N/A
Z36S6SHC	16 x 36 x 65.5-66	125	205.02	26.50	\$1486	\$1535	\$1268	N/A
Z30S6SHC	16 x 30 x 65.5-66	125	178.73	22.50	\$1309	\$1342	\$1112	N/A

Laminate doors are standard. **Includes two 3-position fixed/height adjustable shelves.** Upper and lower locks secure both compartments.

Required Specifications

- Top finish
- Top/edge detail
- Handles
- Base finish

Optional Specifications

- Collator*
- Glazed doors**

STORAGE MODULES - 65" / 65.5" HIGH

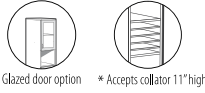
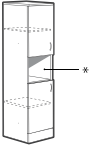

Storage Cabinet with Doors and Cavity - LEFT*

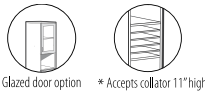
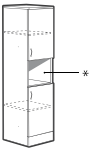

Storage Cabinet with Doors and Cavity - RIGHT*

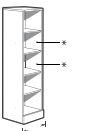
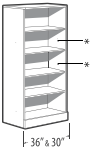

Open Storage Cabinet

MODEL#	DIMENSIONS D x W x H	FREIGHT CLASS	WT./LBS.	CUBIC FT.	1" TOP	1.5" TOP	GLAZE ADD	HP ADD
Z21L6SHCL	24 x 21 x 65.5-66	125	182.12	23.50	\$1253	\$1293	\$698	N/A
Z18L6SHCL	24 x 18 x 65.5-66	100	164.95	20.50	\$1174	\$1208	\$630	N/A
Z16L6SHCL	24 x 16 x 65.5-66	100	154.21	18.75	\$1104	\$1137	\$620	N/A
Z15L6SHCL	24 x 15 x 65.5-66	100	147.78	17.50	\$1078	\$1106	\$552	N/A
Z12L6SHCL	24 x 12 x 65.5-66	100	130.62	14.50	\$985	\$1010	\$498	N/A
Z21M6SHCL	20 x 21 x 65.5-66	100	165.16	20	\$1123	\$1157	\$698	N/A
Z18M6SHCL	20 x 18 x 65.5-66	100	143.97	17.25	\$1075	\$1105	\$630	N/A
Z16M6SHCL	20 x 16 x 65.5-66	100	134.39	15.75	\$1011	\$1040	\$620	N/A
Z15M6SHCL	20 x 15 x 65.5-66	100	130.12	14.75	\$970	\$995	\$552	N/A
Z12M6SHCL	20 x 12 x 65.5-66	100	113.13	12.25	\$905	\$926	\$498	N/A
Z21S6SHCL	16 x 21 x 65.5-66	100	136.66	16	\$1061	\$1089	\$698	N/A
Z18S6SHCL	16 x 18 x 65.5-66	100	121.94	14	\$965	\$994	\$630	N/A
Z16S6SHCL	16 x 16 x 65.5-66	100	113.52	13	\$908	\$936	\$620	N/A
Z15S6SHCL	16 x 15 x 65.5-66	100	108.26	12	\$867	\$890	\$552	N/A
Z12S6SHCL	16 x 12 x 65.5-66	100	94.59	10	\$803	\$822	\$498	N/A

Laminate doors are standard. **Includes two 3-position fixed/height adjustable shelves.** Upper and lower locks secure both compartments.

Z21L6SHCR	24 x 21 x 65.5-66	125	182.12	23.50	\$1253	\$1293	\$698	N/A
Z18L6SHCR	24 x 18 x 65.5-66	100	164.95	20.50	\$1174	\$1208	\$630	N/A
Z16L6SHCR	24 x 16 x 65.5-66	100	154.21	18.75	\$1104	\$1137	\$620	N/A
Z15L6SHCR	24 x 15 x 65.5-66	100	147.78	17.50	\$1078	\$1106	\$552	N/A
Z12L6SHCR	24 x 12 x 65.5-66	100	130.62	14.50	\$985	\$1010	\$498	N/A
Z21M6SHCR	20 x 21 x 65.5-66	100	165.16	20	\$1123	\$1157	\$698	N/A
Z18M6SHCR	20 x 18 x 65.5-66	100	143.97	17.25	\$1075	\$1105	\$630	N/A
Z16M6SHCR	20 x 16 x 65.5-66	100	134.39	15.75	\$1011	\$1040	\$620	N/A
Z15M6SHCR	20 x 15 x 65.5-66	100	130.12	14.75	\$970	\$995	\$552	N/A
Z12M6SHCR	20 x 12 x 65.5-66	100	113.13	12.25	\$905	\$926	\$498	N/A
Z21S6SHCR	16 x 21 x 65.5-66	100	136.66	16	\$1061	\$1089	\$698	N/A
Z18S6SHCR	16 x 18 x 65.5-66	100	121.94	14	\$965	\$994	\$630	N/A
Z16S6SHCR	16 x 16 x 65.5-66	100	113.52	13	\$908	\$936	\$620	N/A
Z15S6SHCR	16 x 15 x 65.5-66	100	108.26	12	\$867	\$890	\$552	N/A
Z12S6SHCR	16 x 12 x 65.5-66	100	94.59	10	\$803	\$822	\$498	N/A

Laminate doors are standard. **Includes two 3-position fixed/height adjustable shelves.** Upper and lower locks secure both compartments.

Z36L6SHN	24 x 36 x 65.5-66	125	234.42	39	\$1324	\$1382	N/A	N/A
Z30L6SHN	24 x 30 x 65.5-66	125	205.50	32.75	\$1173	\$1223	N/A	N/A
Z21L6SHN	24 x 21 x 65.5-66	125	163.17	23.50	\$1018	\$1059	N/A	N/A
Z18L6SHN	24 x 18 x 65.5-66	125	148.71	20.50	\$955	\$989	N/A	N/A
Z16L6SHN	24 x 16 x 65.5-66	125	139.77	18.75	\$890	\$923	N/A	N/A
Z15L6SHN	24 x 15 x 65.5-66	125	134.25	17.50	\$880	\$908	N/A	N/A
Z12L6SHN	24 x 12 x 65.5-66	100	119.79	14.50	\$799	\$822	N/A	N/A
Z36M6SHN	20 x 36 x 65.5-66	125	206.11	33.25	\$1198	\$1248	N/A	N/A
Z30M6SHN	20 x 30 x 65.5-66	125	178.58	27.75	\$1060	\$1102	N/A	N/A
Z21M6SHN	20 x 21 x 65.5-66	125	146.22	20	\$890	\$924	N/A	N/A
Z18M6SHN	20 x 18 x 65.5-66	125	127.73	17.25	\$858	\$888	N/A	N/A
Z16M6SHN	20 x 16 x 65.5-66	125	119.95	15.75	\$797	\$826	N/A	N/A
Z15M6SHN	20 x 15 x 65.5-66	125	116.59	14.75	\$773	\$798	N/A	N/A
Z12M6SHN	20 x 12 x 65.5-66	100	102.30	12.25	\$719	\$739	N/A	N/A
Z36S6SHN	16 x 36 x 65.5-66	125	172.54	26.50	\$1050	\$1099	N/A	N/A
Z30S6SHN	16 x 30 x 65.5-66	125	151.66	22.50	\$911	\$945	N/A	N/A
Z21S6SHN	16 x 21 x 65.5-66	125	117.71	16	\$802	\$830	N/A	N/A
Z18S6SHN	16 x 18 x 65.5-66	125	105.70	14	\$748	\$776	N/A	N/A
Z16S6SHN	16 x 16 x 65.5-66	125	99.09	13	\$695	\$723	N/A	N/A
Z15S6SHN	16 x 15 x 65.5-66	125	94.73	12	\$671	\$694	N/A	N/A
Z12S6SHN	16 x 12 x 65.5-66	100	83.76	10	\$617	\$637	N/A	N/A

Includes four 3-position fixed/height adjustable shelves.

Required Specifications

- Top finish
- Top/edge detail
- Handles
- Base finish

Optional Specifications

- Collator
- Glazed doors*

STORAGE MODULES - 65" / 65.5" HIGH

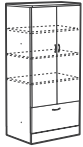

Glazed door option

File Module with Doors*

MODEL#	DIMENSIONS	FREIGHT CLASS	WT/LBS.	CUBIC FT.	1" TOP	1.5" TOP	GLAZE ADD	HP ADD
D x W x H								
Z36L6F	24 x 36 x 65.5-66	125	290.85	39	\$1972	\$2029	\$944	N/A
Z30L6F	24 x 30 x 65.5-66	125	255.15	32.75	\$1787	\$1837	\$821	N/A
Z36M6F	20 x 36 x 65.5-66	100	266.70	33.25	\$1885	\$1935	\$944	N/A
Z30M6F	20 x 30 x 65.5-66	100	228.90	27.75	\$1661	\$1703	\$821	N/A
Z36S6F	16 x 36 x 65.5-66	100	219.45	26.50	\$1660	\$1709	\$944	N/A
Z30S6F	16 x 30 x 65.5-66	100	192.15	22.50	\$1492	\$1525	\$821	N/A

One lateral file drawer. Laminate doors are standard. **Includes three 3-position fixed/height adjustable shelves.** Upper lock secures storage compartment. Lower lock secures one file drawer. Front-to-back and side-to-side letter/legal filing capability. Side-to-side file bars included.

- Lateral file drawer construction is for accommodating hanging files NOT for stacking materials on the drawer bottom.



Glazed door option

File Module with Door - LEFT*

Z16L6FL	24 x 16 x 65.5-66	100	165.90	18.75	\$1208	\$1242	\$944	N/A
Z15L6FL	24 x 15 x 65.5-66	100	159.60	17.50	\$1176	\$1204	\$821	N/A
Z16M6FL	20 x 16 x 65.5-66	100	147	15.75	\$1115	\$1144	\$464	N/A
Z15M6FL	20 x 15 x 65.5-66	100	141.75	14.75	\$1068	\$1093	\$408	N/A
Z16S6FL	16 x 16 x 65.5-66	100	124.95	13	\$1009	\$1037	\$464	N/A
Z15S6FL	16 x 15 x 65.5-66	100	119.70	12	\$970	\$993	\$408	N/A

One file drawer. Laminate door is standard. **Includes three 3-position fixed/height adjustable shelves.** Upper lock secures storage compartment. Lower lock secures one file drawer.

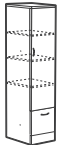

Glazed door option

File Module with Door - RIGHT*

Z16L6FR	24 x 16 x 65.5-66	100	165.90	18.75	\$1208	\$1242	\$944	N/A
Z15L6FR	24 x 15 x 65.5-66	100	159.60	17.50	\$1176	\$1204	\$821	N/A
Z16M6FR	20 x 16 x 65.5-66	100	147	15.75	\$1115	\$1144	\$464	N/A
Z15M6FR	20 x 15 x 65.5-66	100	141.75	14.75	\$1068	\$1093	\$408	N/A
Z16S6FR	16 x 16 x 65.5-66	100	124.95	13	\$1009	\$1037	\$464	N/A
Z15S6FR	16 x 15 x 65.5-66	100	119.70	12	\$970	\$993	\$408	N/A

One file drawer. Laminate door is standard. **Includes three 3-position fixed/height adjustable shelves.** Upper lock secures storage compartment. Lower lock secures one file drawer.

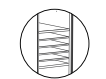
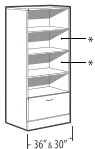

* Accepts collator 11" high

File Module with Open Shelves**

Z36L6FN	24 x 36 x 65.5-66	125	260.25	39	\$1634	\$1691	N/A	N/A
Z30L6FN	24 x 30 x 65.5-66	125	228.95	32.75	\$1484	\$1534	N/A	N/A
Z16L6FN	24 x 16 x 65.5-66	100	152.77	18.75	\$1045	\$1078	N/A	N/A
Z15L6FN	24 x 15 x 65.5-66	100	148.08	17.50	\$1032	\$1060	N/A	N/A
Z36M6FN	20 x 36 x 65.5-66	125	234.04	33.25	\$1547	\$1597	N/A	N/A
Z30M6FN	20 x 30 x 65.5-66	125	202.03	27.75	\$1359	\$1402	N/A	N/A
Z16M6FN	20 x 16 x 65.5-66	100	132.95	15.75	\$951	\$980	N/A	N/A
Z15M6FN	20 x 15 x 65.5-66	100	128.32	14.75	\$924	\$947	N/A	N/A
Z36S6FN	16 x 36 x 65.5-66	125	189.97	26.50	\$1322	\$1372	N/A	N/A
Z30S6FN	16 x 30 x 65.5-66	125	166.71	22.50	\$1191	\$1224	N/A	N/A
Z16S6FN	16 x 16 x 65.5-66	100	111.03	13	\$846	\$874	N/A	N/A
Z15S6FN	16 x 15 x 65.5-66	100	106.46	12	\$824	\$846	N/A	N/A

Four open shelves and one file drawer on bottom. **Includes three 3-position fixed/height adjustable shelves.** Lock secures file drawer. 36" and 30" wide models have front-to-back and side-to-side letter/legal filing capability. Side-to-side file bars included.

- Lateral file drawer construction is for accommodating hanging files NOT for stacking materials on the drawer bottom.

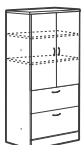

Glazed door option

Two File Module with Doors*

Z36L6E	24 x 36 x 65.5-66	125	294	39	\$2156	\$2214	\$767	N/A
Z30L6E	24 x 30 x 65.5-66	125	260.40	32.75	\$1971	\$2021	\$671	N/A
Z36M6E	20 x 36 x 65.5-66	100	269.85	33.25	\$2065	\$2115	\$767	N/A
Z30M6E	20 x 30 x 65.5-66	100	236.25	27.75	\$1867	\$1910	\$671	N/A
Z36S6E	16 x 36 x 65.5-66	100	225	26.50	\$1766	\$1816	\$767	N/A
Z30S6E	16 x 30 x 65.5-66	100	197	22.50	\$1690	\$1723	\$671	N/A

Two lateral file drawers on bottom. Laminate doors are standard. **Includes two 3-position fixed/height adjustable shelves.** Upper lock secures storage compartment. Lower lock secures two file drawers. Front-to-back and side-to-side letter/legal filing capability. Side-to-side file bars included.

- Lateral file drawer construction is for accommodating hanging files NOT for stacking materials on the drawer bottom.

Required Specifications

Top finish
Top/edge detail
Handles
Base finish

Optional Specifications

Collator**
Glazed doors*
Box drawer - no upcharge

STORAGE MODULES - 65" / 65.5" HIGH

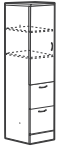

Glazed door option

Two File Module with Door - LEFT

MODEL#	DIMENSIONS D x W x H	FREIGHT CLASS	WT/LBS.	CUBIC FT.	1" TOP	1.5" TOP	GLAZE ADD	HP ADD
Z16L6EL	24 x 16 x 65.5-66	100	171.15	18.75	\$1277	\$1311	\$374	N/A
Z15L6EL	24 x 15 x 65.5-66	100	163.80	17.50	\$1247	\$1275	\$332	N/A
Z16M6EL	20 x 16 x 65.5-66	100	153.30	15.75	\$1187	\$1216	\$374	N/A
Z15M6EL	20 x 15 x 65.5-66	92.5	148.05	14.75	\$1144	\$1169	\$332	N/A
Z16S6EL	16 x 16 x 65.5-66	100	129.15	13	\$1084	\$1112	\$374	N/A
Z15S6EL	16 x 15 x 65.5-66	92.5	123.90	12	\$1050	\$1073	\$332	N/A

Two file drawers on bottom. Laminate door is standard. **Includes two 3-position fixed/height adjustable shelves.** Upper lock secures storage compartment. Lower lock secures two file drawers.

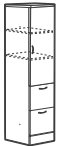

Glazed door option

Two File Module with Door - RIGHT

Z16L6ER	24 x 16 x 65.5-66	100	171.15	18.75	\$1277	\$1311	\$374	N/A
Z15L6ER	24 x 15 x 65.5-66	100	163.80	17.50	\$1247	\$1275	\$332	N/A
Z16M6ER	20 x 16 x 65.5-66	100	153.30	15.75	\$1187	\$1216	\$374	N/A
Z15M6ER	20 x 15 x 65.5-66	92.5	148.05	14.75	\$1144	\$1169	\$332	N/A
Z16S6ER	16 x 16 x 65.5-66	100	129.15	13	\$1084	\$1112	\$374	N/A
Z15S6ER	16 x 15 x 65.5-66	92.5	123.90	12	\$1050	\$1073	\$332	N/A

Two file drawers on bottom. Laminate door is standard. **Includes three 3-position fixed/height adjustable shelves.** Upper lock secures storage compartment. Lower lock secures two file drawers.

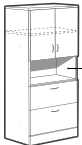

Glazed door option



* Accepts collator 11" high

Two File Module with Doors and Cavity*

Z36L6EC	24 x 36 x 65.5-66	125	287.90	39	\$2111	\$2168	\$677	N/A
Z30L6EC	24 x 30 x 65.5-66	125	254.62	32.75	\$1933	\$1983	\$589	N/A
Z36M6EC	20 x 36 x 65.5-66	125	261.69	33.25	\$2019	\$2069	\$677	N/A
Z30M6EC	20 x 30 x 65.5-66	100	229.80	27.75	\$1830	\$1873	\$589	N/A
Z36S6EC	16 x 36 x 65.5-66	100	218.67	26.50	\$1586	\$1635	\$677	N/A
Z30S6EC	16 x 30 x 65.5-66	100	191.33	22.50	\$1518	\$1551	\$589	N/A

Two lateral file drawers on bottom. Laminate doors are standard. **Includes one 3-position fixed/height adjustable shelf.** Upper lock secures storage compartment. Lower lock secures all drawers. Front-to-back and side-to-side letter/legal filing capability. Side-to-side file bars included.

• Lateral file drawer construction is for accommodating hanging files NOT for stacking materials on the drawer bottom.

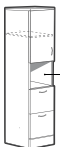

Glazed door option



* Accepts collator 11" high

Two File Module with Doors and Cavity - LEFT*

Z16L6ECL	24 x 16 x 65.5-66	100	168.91	18.75	\$1253	\$1287	\$332	N/A
Z15L6ECL	24 x 15 x 65.5-66	100	162.48	17.50	\$1229	\$1256	\$294	N/A
Z16M6ECL	20 x 16 x 65.5-66	100	150.14	15.75	\$1154	\$1183	\$332	N/A
Z15M6ECL	20 x 15 x 65.5-66	100	144.82	14.75	\$1115	\$1138	\$294	N/A
Z16S6ECL	16 x 16 x 65.5-66	100	126.12	13	\$1060	\$1088	\$332	N/A
Z15S6ECL	16 x 15 x 65.5-66	92.5	120.86	12	\$1032	\$1054	\$294	N/A

Two file drawers on bottom. Laminate doors are standard. **Includes one 3-position fixed/height adjustable shelf.** Upper lock secures storage compartment. Lower lock secures all drawers.

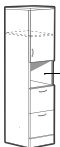

Glazed door option



* Accepts collator 11" high

Two File Module with Doors and Cavity - RIGHT*

Z16L6ECR	24 x 16 x 65.5-66	100	168.91	18.75	\$1253	\$1287	\$332	N/A
Z15L6ECR	24 x 15 x 65.5-66	100	162.48	17.50	\$1229	\$1256	\$294	N/A
Z16M6ECR	20 x 16 x 65.5-66	100	150.14	15.75	\$1154	\$1183	\$332	N/A
Z15M6ECR	20 x 15 x 65.5-66	100	144.82	14.75	\$1115	\$1138	\$294	N/A
Z16S6ECR	16 x 16 x 65.5-66	100	126.12	13	\$1060	\$1088	\$332	N/A
Z15S6ECR	16 x 15 x 65.5-66	92.5	120.86	12	\$1032	\$1054	\$294	N/A

Two file drawers on bottom. Laminate doors are standard. **Includes one 3-position fixed/height adjustable shelf.** Upper lock secures storage compartment. Lower lock secures all drawers.

Required Specifications

Top finish
Top/edge detail
Handles
Base finish

Optional Specifications

Collator*
Glazed doors
Box drawer - no upcharge

STORAGE MODULES - 65" / 65.5" HIGH

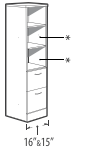
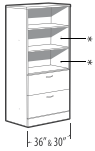

* Accepts collator 11" high

Two File Module with Open Shelves

MODEL#	DIMENSIONS D x W x H	FREIGHT CLASS	WT/LBS.	CUBIC FT.	1" TOP	1.5" TOP	GLAZE ADD	HP ADD
Z36L6EN	24 x 36 x 65.5-66	125	271.38	39	\$1883	\$1941	N/A	N/A
Z30L6EN	24 x 30 x 65.5-66	125	240.85	32.75	\$1726	\$1776	N/A	N/A
Z16L6EN	24 x 16 x 65.5-66	100	161.56	18.75	\$1146	\$1179	N/A	N/A
Z15L6EN	24 x 15 x 65.5-66	100	155.60	17.50	\$1129	\$1157	N/A	N/A
Z36M6EN	20 x 36 x 65.5-66	125	243.07	33.25	\$1791	\$1841	N/A	N/A
Z30M6EN	20 x 30 x 65.5-66	125	213.93	27.75	\$1622	\$1665	N/A	N/A
Z16M6EN	20 x 16 x 65.5-66	100	142.80	15.75	\$1057	\$1086	N/A	N/A
Z15M6EN	20 x 15 x 65.5-66	100	137.94	14.75	\$1025	\$1050	N/A	N/A
Z36S6EN	16 x 36 x 65.5-66	125	202.15	26.50	\$1491	\$1541	N/A	N/A
Z30S6EN	16 x 30 x 65.5-66	125	177.56	22.50	\$1444	\$1477	N/A	N/A
Z16S6EN	16 x 16 x 65.5-66	100	118.78	13	\$952	\$980	N/A	N/A
Z15S6EN	16 x 15 x 65.5-66	100	113.98	12	\$933	\$956	N/A	N/A

Three open shelves and two file drawers on bottom. **Includes two 3-position fixed/height adjustable shelves.** Lock secures all drawers. 36" and 30" wide models have front-to-back and side-to-side letter/legal filing capability. Side-to-side file bars included.

- Lateral file drawer construction is for accommodating hanging files NOT for stacking materials on the drawer bottom.

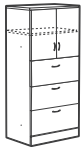

Glazed door option

Three File Module with Doors**

Z36L63F	24 x 36 x 65.5-66	125	297.15	39	\$2379	\$2437	\$677	N/A
Z30L63F	24 x 30 x 65.5-66	100	266.70	32.75	\$2212	\$2262	\$589	N/A
Z36M63F	20 x 36 x 65.5-66	100	275.10	33.25	\$2298	\$2348	\$677	N/A
Z30M63F	20 x 30 x 65.5-66	100	244.65	27.75	\$2110	\$2153	\$589	N/A
Z36S63F	16 x 36 x 65.5-66	100	233.10	26.50	\$2063	\$2112	\$677	N/A
Z30S63F	16 x 30 x 65.5-66	100	204.75	22.50	\$1879	\$1912	\$589	N/A

Three lateral file drawers on bottom. Laminate doors are standard. **Includes one 3-position fixed/height adjustable shelf.** Upper lock secures storage compartment. Lower lock secures three file drawers. Front-to-back and side-to-side letter/legal filing capability. Side-to-side file bars included.

- Lateral file drawer construction is for accommodating hanging files NOT for stacking materials on the drawer bottom.



Glazed door option

Three File Module with Door - LEFT**

Z16L63FL	24 x 16 x 65.5-66	100	176.40	18.75	\$1389	\$1422	\$332	N/A
Z15L63FL	24 x 15 x 65.5-66	100	169.05	17.50	\$1363	\$1391	\$294	N/A
Z16M63FL	20 x 16 x 65.5-66	92.5	159.60	15.75	\$1304	\$1333	\$332	N/A
Z15M63FL	20 x 15 x 65.5-66	92.5	153.30	14.75	\$1265	\$1288	\$294	N/A
Z16S63FL	16 x 16 x 65.5-66	92.5	134.40	13	\$1195	\$1223	\$332	N/A
Z15S63FL	16 x 15 x 65.5-66	92.5	129.15	12	\$1166	\$1189	\$294	N/A

Three file drawers on bottom. Laminate door is standard. **Includes one 3-position fixed/height adjustable shelf.** Upper lock secures storage compartment. Lower lock secures three file drawers.

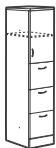

Glazed door option

Three File Module with Door - RIGHT**

Z16L63FR	24 x 16 x 65.5-66	100	176.40	18.75	\$1389	\$1422	\$332	N/A
Z15L63FR	24 x 15 x 65.5-66	100	169.05	17.50	\$1363	\$1391	\$294	N/A
Z16M63FR	20 x 16 x 65.5-66	92.5	159.60	15.75	\$1304	\$1333	\$332	N/A
Z15M63FR	20 x 15 x 65.5-66	92.5	153.30	14.75	\$1265	\$1288	\$294	N/A
Z16S63FR	16 x 16 x 65.5-66	92.5	134.40	13	\$1195	\$1223	\$332	N/A
Z15S63FR	16 x 15 x 65.5-66	92.5	129.15	12	\$1166	\$1189	\$294	N/A

Three file drawers on bottom. Laminate door is standard. **Includes one 3-position fixed/height adjustable shelf.** Upper lock secures storage compartment. Lower lock secures three file drawers.

Required Specifications

Top finish
Top/edge detail
Handles
Base finish

Optional Specifications

Collator*
Glazed doors**
Box drawer - no upcharge

STORAGE MODULES - 65" / 65.5" HIGH

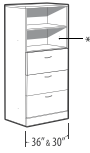

* Accepts collator 11" high

Three File Module with Open Shelves*

MODEL#	DIMENSIONS D x W x H	FREIGHT CLASS	WT./LBS.	CUBIC FT.	1" TOP	1.5" TOP	GLAZE ADD	HP ADD
Z36L63FN	24 x 36 x 65.5-66	125	282.51	39	\$2151	\$2208	N/A	N/A
Z30L63FN	24 x 30 x 65.5-66	125	253.80	32.75	\$2003	\$2053	N/A	N/A
Z16L63FN	24 x 16 x 65.5-66	100	170.36	18.75	\$1281	\$1314	N/A	N/A
Z15L63FN	24 x 15 x 65.5-66	100	164.18	17.50	\$1263	\$1291	N/A	N/A
Z36M63FN	20 x 36 x 65.5-66	125	258.40	33.25	\$2070	\$2120	N/A	N/A
Z30M63FN	20 x 30 x 65.5-66	100	231.08	27.75	\$1902	\$1945	N/A	N/A
Z16M63FN	20 x 16 x 65.5-66	100	152.64	15.75	\$1197	\$1226	N/A	N/A
Z15M63FN	20 x 15 x 65.5-66	100	146.52	14.75	\$1166	\$1189	N/A	N/A
Z36S63FN	16 x 36 x 65.5-66	100	219.59	26.50	\$1834	\$1884	N/A	N/A
Z30S63FN	16 x 30 x 65.5-66	100	192.61	22.50	\$1669	\$1702	N/A	N/A
Z16S63FN	16 x 16 x 65.5-66	100	127.58	13	\$1087	\$1115	N/A	N/A
Z15S63FN	16 x 15 x 65.5-66	92.5	122.56	12	\$1069	\$1091	N/A	N/A

Two open shelves and three file drawers on bottom. **Includes one 3-position fixed/height adjustable shelf.** Lock secures all drawers. 36" and 30" wide models have front-to-back and side-to-side letter/legal filing capability. Side-to-side file bars included.

• Lateral file drawer construction is for accommodating hanging files NOT for stacking materials on the drawer bottom.

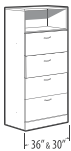

Four File Module with Open Shelf

Z36L64FN	24 x 36 x 65.5-66	125	300.30	39	\$2398	\$2456	N/A	N/A
Z30L64FN	24 x 30 x 65.5-66	100	271.95	32.75	\$2251	\$2301	N/A	N/A
Z16L64FN	24 x 16 x 65.5-66	100	180.60	18.75	\$1377	\$1411	N/A	N/A
Z15L64FN	24 x 15 x 65.5-66	100	174.30	17.50	\$1349	\$1377	N/A	N/A
Z36M64FN	20 x 36 x 65.5-66	100	271.95	33.25	\$2320	\$2371	N/A	N/A
Z30M64FN	20 x 30 x 65.5-66	100	245.70	27.75	\$2160	\$2202	N/A	N/A
Z16M64FN	20 x 16 x 65.5-66	92.5	161.70	15.75	\$1303	\$1332	N/A	N/A
Z15M64FN	20 x 15 x 65.5-66	92.5	155.40	14.75	\$1262	\$1285	N/A	N/A
Z36S64FN	16 x 36 x 65.5-66	100	228.90	26.50	\$2080	\$2129	N/A	N/A
Z30S64FN	16 x 30 x 65.5-66	100	202.65	22.50	\$1897	\$1930	N/A	N/A
Z16S64FN	16 x 16 x 65.5-66	92.5	134.40	13	\$1192	\$1220	N/A	N/A
Z15S64FN	16 x 15 x 65.5-66	92.5	130.20	12	\$1174	\$1197	N/A	N/A

Open shelf and four file drawers. Lock secures all drawers. 36" and 30" wide models have front-to-back and side-to-side letter/legal filing capability. Side-to-side file bars included.

• Lateral file drawer construction is for accommodating hanging files NOT for stacking materials on the drawer bottom.

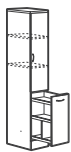

Glazed door option

LEFT RIGHT

Vertical Utility Drawer with Door**

Z12L6VDL	24 x 12 x 65.5-66	92.5	160.65	14.50	\$1110	\$1135	\$300	N/A
Z12M6VDL	20 x 12 x 65.5-66	92.5	139.65	12.25	\$1011	\$1032	\$300	N/A
Z12S6VDL	16 x 12 x 65.5-66	92.5	116.55	10	\$933	\$952	\$300	N/A
Z12L6VDR	24 x 12 x 65.5-66	92.5	160.65	14.50	\$1110	\$1135	\$300	N/A
Z12M6VDR	20 x 12 x 65.5-66	92.5	139.65	12.25	\$1011	\$1032	\$300	N/A
Z12S6VDR	16 x 12 x 65.5-66	92.5	116.55	10	\$933	\$952	\$300	N/A

Specify **VDL** models for **LEFT** or **VDR** models for **RIGHT**

Laminate doors are standard. **Includes two 3-position fixed/height adjustable shelves** and one vertical drawer. Upper lock secures storage compartment. Lower lock secures vertical drawer.

WARDROBE CABINETS - 65" / 65.5" HIGH

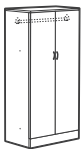

Wardrobe Cabinet

MODEL#	DIMENSIONS	FREIGHT CLASS	WT./LBS.	CUBIC FT.	1" TOP	1.5" TOP	GLAZE ADD	HP ADD
Z36L6WA	24 x 36 x 65.5-66	150	216.30	39	\$1464	\$1521	N/A	N/A
Z30L6WA	24 x 30 x 65.5-66	150	192.15	32.75	\$1318	\$1368	N/A	N/A
Z36M6WA	20 x 36 x 65.5-66	125	200.55	33.25	\$1402	\$1452	N/A	N/A
Z30M6WA	20 x 30 x 65.5-66	125	173.25	27.75	\$1241	\$1284	N/A	N/A

Laminate doors are standard. Full length hanging rod included. Standard with lock.

Required Specifications

Top finish
Top/edge detail
Handles
Base finish

Optional Specifications

Collator*
Glazed doors**
Box drawer - no upcharge

STORAGE MODULES - 65" / 65.5" HIGH



Wardrobe Cabinet - LEFT

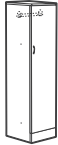

Wardrobe Cabinet - RIGHT

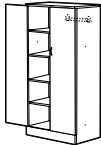

Glazed door option

Wardrobe Cabinet/Shelving Combo with Doors - LEFT*

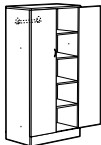

Glazed door option

Wardrobe Cabinet/Shelving Combo with Doors - RIGHT*

MODEL#	DIMENSIONS	FREIGHT CLASS	WT/LBS.	CUBIC FT.	1" TOP	1.5" TOP	GLAZE ADD	HP ADD
D x W x H								
Z24L6WAL	24 x 24 x 65.5-66	125	165.90	26.75	\$1208	\$1249	N/A	N/A
Z21L6WAL	24 x 21 x 65.5-66	125	152.25	23.50	\$1112	\$1152	N/A	N/A
Z18L6WAL	24 x 18 x 65.5-66	125	139.65	20.50	\$987	\$1021	N/A	N/A
Z16L6WAL	24 x 16 x 65.5-66	125	132.30	18.75	\$966	\$1000	N/A	N/A
Z15L6WAL	24 x 15 x 65.5-66	125	128.10	17.50	\$927	\$955	N/A	N/A
Z12L6WAL	24 x 12 x 65.5-66	125	115.50	14.50	\$856	\$879	N/A	N/A
Z24M6WAL	20 x 24 x 65.5-66	125	149.10	22.50	\$1039	\$1073	N/A	N/A
Z21M6WAL	20 x 21 x 65.5-66	125	143.85	20	\$1007	\$1040	N/A	N/A
Z18M6WAL	20 x 18 x 65.5-66	125	124.95	17.25	\$912	\$941	N/A	N/A
Z16M6WAL	20 x 16 x 65.5-66	125	116.55	15.75	\$890	\$919	N/A	N/A
Z15M6WAL	20 x 15 x 65.5-66	125	113.40	14.75	\$836	\$861	N/A	N/A
Z12M6WAL	20 x 12 x 65.5-66	100	102.90	12.25	\$797	\$817	N/A	N/A

Laminate doors are standard. Full length hanging rod included. Standard with lock.

Z24L6WAR	24 x 24 x 65.5-66	125	165.90	26.75	\$1208	\$1249	N/A	N/A
Z21L6WAR	24 x 21 x 65.5-66	125	152.25	23.50	\$1112	\$1152	N/A	N/A
Z18L6WAR	24 x 18 x 65.5-66	125	139.65	20.50	\$987	\$1021	N/A	N/A
Z16L6WAR	24 x 16 x 65.5-66	125	132.30	18.75	\$966	\$1000	N/A	N/A
Z15L6WAR	24 x 15 x 65.5-66	125	128.10	17.50	\$927	\$955	N/A	N/A
Z12L6WAR	24 x 12 x 65.5-66	125	115.50	14.50	\$856	\$879	N/A	N/A
Z24M6WAR	20 x 24 x 65.5-66	125	149.10	22.50	\$1039	\$1073	N/A	N/A
Z21M6WAR	20 x 21 x 65.5-66	125	143.85	20	\$1007	\$1040	N/A	N/A
Z18M6WAR	20 x 18 x 65.5-66	125	124.95	17.25	\$912	\$941	N/A	N/A
Z16M6WAR	20 x 16 x 65.5-66	125	116.55	15.75	\$890	\$919	N/A	N/A
Z15M6WAR	20 x 15 x 65.5-66	125	113.40	14.75	\$836	\$861	N/A	N/A
Z12M6WAR	20 x 12 x 65.5-66	100	102.90	12.25	\$797	\$817	N/A	N/A

Laminate doors are standard. Full length hanging rod included. Standard with lock.

Z36L6DIL	24 x 36 x 65.5-66	125	269.85	39	\$1748	\$1806	\$1109	N/A
Z30L6DIL	24 x 30 x 65.5-66	125	240.45	32.75	\$1549	\$1598	\$959	N/A
Z24L6DIL	24 x 24 x 65.5-66	125	208.95	26.75	\$1445	\$1487	\$866	N/A
Z21L6DIL	24 x 21 x 65.5-66	100	193.20	23.50	\$1357	\$1398	\$858	N/A
Z36M6DIL	20 x 36 x 65.5-66	125	243.60	33.25	\$1645	\$1695	\$1109	N/A
Z30M6DIL	20 x 30 x 65.5-66	100	226.80	27.75	\$1436	\$1479	\$959	N/A
Z24M6DIL	20 x 24 x 65.5-66	100	184.80	22.50	\$1289	\$1323	\$866	N/A
Z21M6DIL	20 x 21 x 65.5-66	100	171.15	20	\$1251	\$1285	\$858	N/A

Laminate doors are standard. Storage compartment on **left includes four 3-position fixed/height adjustable shelves**. Wardrobe compartment on **right** includes hanging rod. Two locks secure storage and wardrobe compartments.

Z36L6DIR	24 x 36 x 65.5-66	125	269.85	39	\$1748	\$1806	\$1109	N/A
Z30L6DIR	24 x 30 x 65.5-66	125	240.45	32.75	\$1549	\$1598	\$959	N/A
Z24L6DIR	24 x 24 x 65.5-66	125	208.95	26.75	\$1445	\$1487	\$866	N/A
Z21L6DIR	24 x 21 x 65.5-66	100	193.20	23.50	\$1357	\$1398	\$858	N/A
Z36M6DIR	20 x 36 x 65.5-66	125	243.60	33.25	\$1645	\$1695	\$1109	N/A
Z30M6DIR	20 x 30 x 65.5-66	100	226.80	27.75	\$1436	\$1479	\$959	N/A
Z24M6DIR	20 x 24 x 65.5-66	100	184.80	22.50	\$1289	\$1323	\$866	N/A
Z21M6DIR	20 x 21 x 65.5-66	100	171.15	20	\$1251	\$1285	\$858	N/A

Laminate doors are standard. Storage compartment on **right includes four 3-position fixed/height adjustable shelves**. Wardrobe compartment on **left** includes hanging rod. Two locks secure storage and wardrobe compartments.

Required Specifications

- Top finish
- Top/edge detail
- Handles
- Base finish

Optional Specifications

- Glazed doors*

WARDROBE CABINETS - 65" / 65.5" HIGH

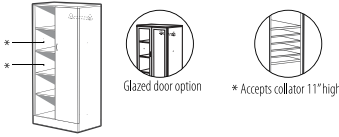

Wardrobe Cabinet/Open Shelving Combo - LEFT*

MODEL#	DIMENSIONS D x W x H	FREIGHT CLASS	WT./LBS.	CUBIC FT.	1" TOP	1.5" TOP	GLAZE ADD	HP ADD
Z36L6DINL	24 x 36 x 65.5-66	125	251.50	39	\$1563	\$1621	\$553	N/A
Z30L6DINL	24 x 30 x 65.5-66	125	224.46	32.75	\$1395	\$1445	\$478	N/A
Z24L6DINL	24 x 24 x 65.5-66	125	196.37	26.75	\$1316	\$1357	\$430	N/A
Z21L6DINL	24 x 21 x 65.5-66	125	183.37	23.50	\$1228	\$1269	\$427	N/A
Z36M6DINL	20 x 36 x 65.5-66	125	223.19	33.25	\$1461	\$1512	\$553	N/A
Z30M6DINL	20 x 30 x 65.5-66	125	197.54	27.75	\$1283	\$1326	\$478	N/A
Z24M6DINL	20 x 24 x 65.5-66	125	174.14	22.50	\$1159	\$1193	\$430	N/A
Z21M6DINL	20 x 21 x 65.5-66	125	159.07	20	\$1121	\$1155	\$427	N/A

Laminate door is standard. Storage compartment on **left includes four 3-position fixed/height adjustable shelves**. Wardrobe compartment on **right** includes hanging rod. Single lock secures storage and wardrobe compartments.



Wardrobe Cabinet/Open Shelving Combo - RIGHT*

Z36L6DINR	24 x 36 x 65.5-66	125	251.50	39	\$1563	\$1621	\$553	N/A
Z30L6DINR	24 x 30 x 65.5-66	125	224.46	32.75	\$1395	\$1445	\$478	N/A
Z24L6DINR	24 x 24 x 65.5-66	125	196.37	26.75	\$1316	\$1357	\$430	N/A
Z21L6DINR	24 x 21 x 65.5-66	125	183.37	23.50	\$1228	\$1269	\$427	N/A
Z36M6DINR	20 x 36 x 65.5-66	125	223.19	33.25	\$1461	\$1512	\$553	N/A
Z30M6DINR	20 x 30 x 65.5-66	125	197.54	27.75	\$1283	\$1326	\$478	N/A
Z24M6DINR	20 x 24 x 65.5-66	125	174.14	22.50	\$1159	\$1193	\$430	N/A
Z21M6DINR	20 x 21 x 65.5-66	125	159.07	20	\$1121	\$1155	\$427	N/A

Laminate door is standard. Storage compartment on **right includes four 3-position fixed/height adjustable shelves**. Wardrobe compartment on **left** includes hanging rod. Single lock secures storage and wardrobe compartments.

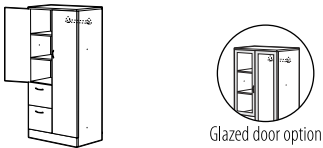

Personal Tower with Doors - LEFT

Z36L6EL	24 x 36 x 65.5-66	125	290.85	39	\$1919	\$1976	\$931	N/A
Z30L6EL	24 x 30 x 65.5-66	100	266.70	32.75	\$1775	\$1825	\$847	N/A
Z24L6EL	24 x 24 x 65.5-66	100	243.24	26.75	\$1702	\$1743	\$742	N/A
Z36M6EL	20 x 36 x 65.5-66	125	256.20	33.25	\$1816	\$1866	\$931	N/A
Z30M6EL	20 x 30 x 65.5-66	100	229.95	27.75	\$1658	\$1701	\$847	N/A
Z24M6EL	20 x 24 x 65.5-66	100	217	22.50	\$1590	\$1624	\$742	N/A

Two file drawers on bottom. Laminate doors are standard. Storage compartment on **left includes two 3-position fixed/height adjustable shelves**. Wardrobe compartment on **right** includes hanging rod. Two upper locks secure storage and wardrobe compartments. Lower lock secures all drawers.

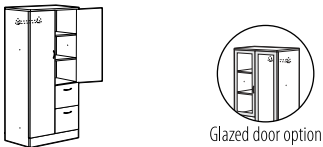

Personal Tower with Doors - RIGHT

Z36L6ER	24 x 36 x 65.5-66	125	290.85	39	\$1919	\$1976	\$931	N/A
Z30L6ER	24 x 30 x 65.5-66	100	266.70	32.75	\$1775	\$1825	\$847	N/A
Z24L6ER	24 x 24 x 65.5-66	100	243.24	26.75	\$1702	\$1743	\$742	N/A
Z36M6ER	20 x 36 x 65.5-66	125	256.20	33.25	\$1816	\$1866	\$931	N/A
Z30M6ER	20 x 30 x 65.5-66	100	229.95	27.75	\$1658	\$1701	\$847	N/A
Z24M6ER	20 x 24 x 65.5-66	100	217	22.50	\$1590	\$1624	\$742	N/A

Two file drawers on bottom. Laminate doors are standard. Storage compartment on **right includes four 3-position fixed/height adjustable shelves**. Wardrobe compartment on **left** includes hanging rod. Two upper locks secure storage and wardrobe compartments. Lower lock secures all drawers.

PERSONAL TOWERS - 65" / 65.5" HIGH

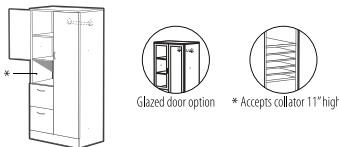

Personal Tower with Doors and cavity - LEFT*

Z36L6ECL	24 x 36 x 65.5-66	125	288.74	39	\$1894	\$1952	\$888	N/A
Z30L6ECL	24 x 30 x 65.5-66	100	264.24	32.75	\$1751	\$1801	\$806	N/A
Z24L6ECL	24 x 24 x 65.5-66	100	239.24	26.75	\$1678	\$1719	\$700	N/A
Z36M6ECL	20 x 36 x 65.5-66	125	252.03	33.25	\$1782	\$1832	\$888	N/A
Z30M6ECL	20 x 30 x 65.5-66	100	226.82	27.75	\$1624	\$1666	\$806	N/A
Z24M6ECL	20 x 24 x 65.5-66	100	213	22.50	\$1567	\$1601	\$700	N/A

Two file drawers on bottom. Laminate doors are standard. Storage compartment on **left includes one 3-position fixed/height adjustable shelf**. Wardrobe compartment on **right** includes hanging rod. Two upper locks secure storage and wardrobe compartments. Lower lock secures all drawers.

Required Specifications

Top finish
Top/edge detail
Handles
Base finish

Optional Specifications

Collator*
Glazed doors

PERSONAL TOWERS - 65" / 65.5" HIGH

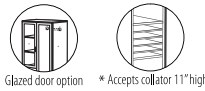
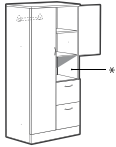

Personal Tower with Doors and cavity - RIGHT*

MODEL#	DIMENSIONS D x W x H	FREIGHT CLASS	WT/LBS.	CUBIC FT.	1" TOP	1.5" TOP	GLAZE ADD	HP ADD
Z36L6ECR	24 x 36 x 65.5-66	125	288.74	39	\$1894	\$1952	\$888	N/A
Z30L6ECR	24 x 30 x 65.5-66	100	264.24	32.75	\$1751	\$1801	\$806	N/A
Z24L6ECR	24 x 24 x 65.5-66	100	239.24	26.75	\$1678	\$1719	\$700	N/A
Z36M6ECR	20 x 36 x 65.5-66	125	252.03	33.25	\$1782	\$1832	\$888	N/A
Z30M6ECR	20 x 30 x 65.5-66	100	226.82	27.75	\$1624	\$1666	\$806	N/A
Z24M6ECR	20 x 24 x 65.5-66	100	213	22.50	\$1567	\$1601	\$700	N/A

Two file drawers on bottom. Laminate doors are standard. Storage compartment on **right includes one 3-position fixed/height adjustable shelf**. Wardrobe compartment on **left** includes hanging rod. Two upper locks secure storage and wardrobe compartments. Lower lock secures all drawers.

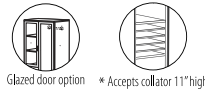
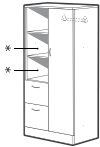

Personal Tower with Open Shelves - LEFT*

Z36L6ENL	24 x 36 x 65.5-66	125	280.48	39	\$1790	\$1847	\$557	N/A
Z30L6ENL	24 x 30 x 65.5-66	125	257.36	32.75	\$1645	\$1695	\$475	N/A
Z24L6ENL	24 x 24 x 65.5-66	100	230.24	26.75	\$1574	\$1615	\$369	N/A
Z36M6ENL	20 x 36 x 65.5-66	125	243.77	33.25	\$1677	\$1727	\$557	N/A
Z30M6ENL	20 x 30 x 65.5-66	125	219.94	27.75	\$1519	\$1562	\$475	N/A
Z24M6ENL	20 x 24 x 65.5-66	100	204	22.50	\$1440	\$1486	\$369	N/A

Two file drawers on bottom. Laminate doors are standard on wardrobe section. Storage compartment on **left includes two 3-position fixed/height adjustable shelves**. Wardrobe compartment on **right** includes hanging rod. Upper lock secures storage and wardrobe compartments. Lower lock secures all drawers.

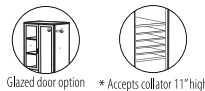

Personal Tower with Open*

Z36L6ENR	24 x 36 x 65.5-66	125	280.48	39	\$1790	\$1847	\$557	N/A
Z30L6ENR	24 x 30 x 65.5-66	125	257.36	32.75	\$1645	\$1695	\$475	N/A
Z24L6ENR	24 x 24 x 65.5-66	100	230.24	26.75	\$1574	\$1615	\$369	N/A
Z36M6ENR	20 x 36 x 65.5-66	125	243.77	33.25	\$1677	\$1727	\$557	N/A
Z30M6ENR	20 x 30 x 65.5-66	125	219.94	27.75	\$1519	\$1562	\$475	N/A
Z24M6ENR	20 x 24 x 65.5-66	100	204	22.50	\$1440	\$1486	\$369	N/A

Two file drawers on bottom. Laminate doors is standard on wardrobe section. Storage compartment on **right includes two 3-position fixed/height adjustable shelves**. Wardrobe compartment on **left** includes hanging rod. Upper lock secures storage and wardrobe compartments. Lower lock secures all drawers.

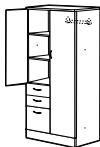

Personal Tower with Doors - LEFT

Z36L6BFL	24 x 36 x 65.5-66	125	294	39	\$2018	\$2075	\$931	N/A
Z30L6BFL	24 x 30 x 65.5-66	100	268.80	32.75	\$1874	\$1924	\$847	N/A
Z24L6BFL	24 x 24 x 65.5-66	100	244.24	26.75	\$1781	\$1823	\$742	N/A
Z36M6BFL	20 x 36 x 65.5-66	125	258.30	33.25	\$1921	\$1971	\$931	N/A
Z30M6BFL	20 x 30 x 65.5-66	100	232.05	27.75	\$1763	\$1806	\$847	N/A
Z24M6BFL	20 x 24 x 65.5-66	100	218	22.50	\$1671	\$1705	\$742	N/A

Two box and one file drawer on bottom. Laminate doors are standard. Storage compartment on **left includes two 3-position fixed/height adjustable shelves**. Wardrobe compartment on **right** includes hanging rod. Two upper locks secure storage and wardrobe compartments. Lower lock secures all drawers.

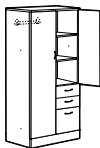

Personal Tower with Doors - RIGHT

Z36L6BFR	24 x 36 x 65.5-66	125	294	39	\$2018	\$2075	\$931	N/A
Z30L6BFR	24 x 30 x 65.5-66	100	268.80	32.75	\$1874	\$1924	\$847	N/A
Z24L6BFR	24 x 24 x 65.5-66	100	244.24	26.75	\$1781	\$1823	\$742	N/A
Z36M6BFR	20 x 36 x 65.5-66	125	258.30	33.25	\$1921	\$1971	\$931	N/A
Z30M6BFR	20 x 30 x 65.5-66	100	232.05	27.75	\$1763	\$1806	\$847	N/A
Z24M6BFR	20 x 24 x 65.5-66	100	218	22.50	\$1671	\$1705	\$742	N/A

Two box and one file drawer on bottom. Laminate doors are standard. Storage compartment on **right includes two 3-position fixed/height adjustable shelves**. Wardrobe compartment on **left** includes hanging rod. Two upper locks secure storage and wardrobe compartments. Lower lock secures all drawers.

Required Specifications

- Top finish
- Top/edge detail
- Handles
- Base finish

Optional Specifications

- Collator*
- Glazed doors
- Box drawer - no upcharge

PERSONAL TOWERS - 65" / 65.5" HIGH

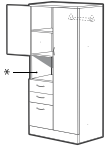

Glazed door option

* Accepts collator 11" high

Personal Tower with Doors*

MODEL#	DIMENSIONS D x W x H	FREIGHT CLASS	WT./LBS.	CUBIC FT.	1" TOP	1.5" TOP	GLAZE ADD	HP ADD
Z36L6BFCL	24 x 36 x 65.5-66	125	291.89	39	\$1995	\$2053	\$888	N/A
Z30L6BFCL	24 x 30 x 65.5-66	100	266.34	32.75	\$1852	\$1902	\$806	N/A
Z24L6BFCL	24 x 24 x 65.5-66	100	240.24	26.75	\$1758	\$1800	\$700	N/A
Z36M6BFCL	20 x 36 x 65.5-66	125	254.13	33.25	\$1882	\$1932	\$888	N/A
Z30M6BFCL	20 x 30 x 65.5-66	100	228.92	27.75	\$1723	\$1766	\$806	N/A
Z24M6BFCL	20 x 24 x 65.5-66	100	214	22.50	\$1648	\$1682	\$700	N/A

Two box and one file drawer on bottom. Laminate doors are standard. Storage compartment on **left** includes **one 3-position fixed/height adjustable shelf**. Wardrobe compartment on **right** includes hanging rod. Two upper locks secure storage and wardrobe compartments. Lower lock secures all drawers.

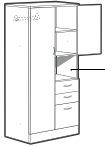

Glazed door option

* Accepts collator 11" high

Personal Tower with Doors and Cavity - RIGHT*

Z36L6BFCL	24 x 36 x 65.5-66	125	291.89	39	\$1995	\$2053	\$888	N/A
Z30L6BFCL	24 x 30 x 65.5-66	100	266.34	32.75	\$1852	\$1902	\$806	N/A
Z24L6BFCL	24 x 24 x 65.5-66	100	240.24	26.75	\$1758	\$1800	\$700	N/A
Z36M6BFCL	20 x 36 x 65.5-66	125	254.13	33.25	\$1882	\$1932	\$888	N/A
Z30M6BFCL	20 x 30 x 65.5-66	100	228.92	27.75	\$1723	\$1766	\$806	N/A
Z24M6BFCL	20 x 24 x 65.5-66	100	214	22.50	\$1648	\$1682	\$700	N/A

Two box and one file drawer on bottom. Laminate doors are standard. Storage compartment on **left** includes **one 3-position fixed/height adjustable shelf**. Wardrobe compartment on **right** includes hanging rod. Two upper locks secure storage and wardrobe compartments. Lower lock secures all drawers.

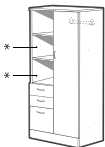

Glazed door option

* Accepts collator 11" high

Personal Tower with Open Shelves - LEFT*

Z36L6BFNL	24 x 36 x 65.5-66	125	280	39	\$1890	\$1947	\$557	N/A
Z30L6BFNL	24 x 30 x 65.5-66	125	257	32.75	\$1746	\$1796	\$475	N/A
Z24L6BFNL	24 x 24 x 65.5-66	100	232	26.75	\$1655	\$1696	\$369	N/A
Z36M6BFNL	20 x 36 x 65.5-66	125	242	33.25	\$1792	\$1842	\$557	N/A
Z30M6BFNL	20 x 30 x 65.5-66	125	219	27.75	\$1634	\$1677	\$475	N/A
Z24M6BFNL	20 x 24 x 65.5-66	100	206	22.50	\$1558	\$1592	\$369	N/A

Two box and one file drawer on bottom. Laminate doors are standard. Storage compartment on **left** includes **two 3-position fixed/height adjustable shelves**. Wardrobe compartment on **right** includes hanging rod. Upper lock secures storage and wardrobe compartments. Lower lock secures all drawers.

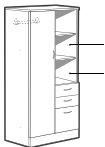

Glazed door option

* Accepts collator 11" high

Personal Tower with Open Shelves - RIGHT*

Z36L6BFNR	24 x 36 x 65.5-66	125	280	39	\$1890	\$1947	\$557	N/A
Z30L6BFNR	24 x 30 x 65.5-66	125	257	32.75	\$1746	\$1796	\$475	N/A
Z24L6BFNR	24 x 24 x 65.5-66	100	232	26.75	\$1655	\$1696	\$369	N/A
Z36M6BFNR	20 x 36 x 65.5-66	125	242	33.25	\$1792	\$1842	\$557	N/A
Z30M6BFNR	20 x 30 x 65.5-66	125	219	27.75	\$1634	\$1677	\$475	N/A
Z24M6BFNR	20 x 24 x 65.5-66	100	206	22.50	\$1558	\$1592	\$369	N/A

Two box and one file drawer on bottom. Laminate doors are standard. Storage compartment on **right** includes **two 3-position fixed/height adjustable shelves**. Wardrobe compartment on **left** includes hanging rod. Upper lock secures storage and wardrobe compartments. Lower lock secures all drawers.

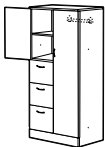

Glazed door option

Personal Tower with Doors - LEFT

Z36L63FL	24 x 36 x 65.5-66	125	295.05	39	\$2021	\$2078	\$888	N/A
Z30L63FL	24 x 30 x 65.5-66	100	273	32.75	\$1887	\$1937	\$806	N/A
Z24L63FL	24 x 24 x 65.5-66	100	247.24	26.75	\$1787	\$1828	\$700	N/A
Z36M63FL	20 x 36 x 65.5-66	125	262.50	33.25	\$1929	\$1979	\$888	N/A
Z30M63FL	20 x 30 x 65.5-66	100	236.25	27.75	\$1778	\$1821	\$806	N/A
Z24M63FL	20 x 24 x 65.5-66	100	223	22.50	\$1679	\$1713	\$700	N/A

Three file drawers on bottom. Laminate doors are standard. Storage compartment on **left** includes **one 3-position fixed/height adjustable shelf**. Wardrobe compartment on **right** includes hanging rod. Two upper locks secure storage and wardrobe compartments. Lower lock secures all drawers.

Required Specifications

- Top finish
- Top/edge detail
- Handles
- Base finish

Optional Specifications

- Collator*
- Glazed doors
- Box drawer - no upcharge

PERSONAL TOWERS - 65" / 65.5" HIGH

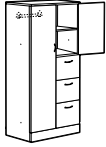

Glazed door option

Personal Tower with Doors - RIGHT

MODEL#	DIMENSIONS D x W x H	FREIGHT CLASS	WT/LBS.	CUBIC FT.	1" TOP	1.5" TOP	GLAZE ADD	HP ADD
Z36L63FR	24 x 36 x 65.5-66	125	295.05	39	\$2021	\$2078	\$888	N/A
Z30L63FR	24 x 30 x 65.5-66	100	273	32.75	\$1887	\$1937	\$806	N/A
Z24L63FR	24 x 24 x 65.5-66	100	247.24	26.75	\$1787	\$1828	\$700	N/A
Z36M63FR	20 x 36 x 65.5-66	125	262.50	33.25	\$1929	\$1979	\$888	N/A
Z30M63FR	20 x 30 x 65.5-66	100	236.25	27.75	\$1778	\$1821	\$806	N/A
Z24M63FR	20 x 24 x 65.5-66	100	223	22.50	\$1679	\$1713	\$700	N/A

Three file drawers on bottom. Laminate doors are standard. Storage compartment on right includes one 3-position fixed/height adjustable shelf. Wardrobe compartment on left includes hanging rod. Two upper locks secure storage and wardrobe compartments. Lower lock secures all drawers.

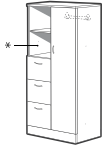

Glazed door option * Accepts collator 11" high

Personal Tower with Open Shelves - LEFT*

Z36L63FNL	24 x 36 x 65.5-66	125	288.67	39	\$1916	\$1974	\$557	N/A
Z30L63FNL	24 x 30 x 65.5-66	100	264.89	32.75	\$1781	\$1831	\$475	N/A
Z24L63FNL	24 x 24 x 65.5-66	100	238.24	26.75	\$1680	\$1722	\$369	N/A
Z36M63FNL	20 x 36 x 65.5-66	125	261.41	33.25	\$1809	\$1859	\$557	N/A
Z30M63FNL	20 x 30 x 65.5-66	100	229.57	27.75	\$1658	\$1701	\$475	N/A
Z24M63FNL	20 x 24 x 65.5-66	100	213	22.50	\$1575	\$1609	\$369	N/A

Three file drawers on bottom. Laminate door is standard on wardrobe section. Storage compartment on left includes one 3-position fixed/height adjustable shelf. Wardrobe compartment on right includes hanging rod. Upper lock secures storage and wardrobe compartments. Lower lock secures all drawers.

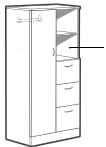

Glazed door option * Accepts collator 11" high

Personal Tower with Open Shelves - RIGHT*

Z36L63FNR	24 x 36 x 65.5-66	125	288.67	39	\$1916	\$1974	\$557	N/A
Z30L63FNR	24 x 30 x 65.5-66	100	264.89	32.75	\$1781	\$1831	\$475	N/A
Z24L63FNR	24 x 24 x 65.5-66	100	238.24	26.75	\$1680	\$1722	\$369	N/A
Z36M63FNR	20 x 36 x 65.5-66	125	261.41	33.25	\$1809	\$1859	\$557	N/A
Z30M63FNR	20 x 30 x 65.5-66	100	229.57	27.75	\$1658	\$1701	\$475	N/A
Z24M63FNR	20 x 24 x 65.5-66	100	213	22.50	\$1575	\$1609	\$369	N/A

Three file drawers on bottom. Laminate door is standard on wardrobe section. Storage compartment on right includes one 3-position fixed/height adjustable shelf. Wardrobe compartment on left includes hanging rod. Upper lock secures storage and wardrobe compartments. Lower lock secures all drawers.

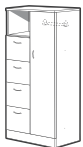

Glazed door option

Personal Tower with Open Shelf - LEFT

Z36L64FNL	24 x 36 x 65.5-66	125	302.40	39	\$2011	\$2068	\$557	N/A
Z30L64FNL	24 x 30 x 65.5-66	100	277.20	32.75	\$1884	\$1934	\$475	N/A
Z24L64FNL	24 x 24 x 65.5-66	100	247.24	26.75	\$1789	\$1831	\$369	N/A
Z36M64FNL	20 x 36 x 65.5-66	125	263.55	33.25	\$1904	\$1954	\$557	N/A
Z30M64FNL	20 x 30 x 65.5-66	100	238.35	27.75	\$1758	\$1801	\$475	N/A
Z24M64FNL	20 x 24 x 65.5-66	100	223	22.50	\$1687	\$1723	\$369	N/A

Four file drawers on bottom. Laminate door is standard on wardrobe section. Storage compartment on left includes one 3-position fixed/height adjustable shelf. Wardrobe compartment on right includes hanging rod. Upper lock secures storage and wardrobe compartments. Lower lock secures all drawers.



Glazed door option

Personal Tower with Open Shelf - RIGHT

Z36L64FNR	24 x 36 x 65.5-66	125	302.40	39	\$2011	\$2068	\$557	N/A
Z30L64FNR	24 x 30 x 65.5-66	100	277.20	32.75	\$1884	\$1934	\$475	N/A
Z24L64FNR	24 x 24 x 65.5-66	100	247.24	26.75	\$1789	\$1831	\$369	N/A
Z36M64FNR	20 x 36 x 65.5-66	125	263.55	33.25	\$1904	\$1954	\$557	N/A
Z30M64FNR	20 x 30 x 65.5-66	100	238.35	27.75	\$1758	\$1801	\$475	N/A
Z24M64FNR	20 x 24 x 65.5-66	100	223	22.50	\$1687	\$1723	\$369	N/A

Four file drawers on bottom. Laminate door is standard on wardrobe section. Storage compartment on right includes one 3-position fixed/height adjustable shelf. Wardrobe compartment on left includes hanging rod. Upper lock secures storage and wardrobe compartments. Lower lock secures all drawers.

Required Specifications

Top finish
Top/edge detail
Handles
Base finish

Optional Specifications

Collator*
Glazed doors
Box drawer - no upcharge

STORAGE MODULES - 71.5" / 72" HIGH

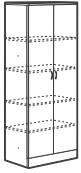

Glazed door option

Storage Cabinet with Doors

MODEL#	DIMENSIONS D x W x H	FREIGHT CLASS	WT./LBS.	CUBIC FT.	1" TOP	1.5" TOP	GLAZE ADD	HP ADD
Z36L7SH	24 x 36 x 71.9-72.4	125	295.05	43.25	\$1785	\$1842	\$1195	N/A
Z30L7SH	24 x 30 x 71.9-72.4	125	253.05	36.25	\$1558	\$1608	\$1034	N/A
Z36M7SH	20 x 36 x 71.9-72.4	125	261.45	36.75	\$1657	\$1707	\$1195	N/A
Z30M7SH	20 x 30 x 71.9-72.4	125	225.75	30.50	\$1436	\$1478	\$1034	N/A
Z36S7SH	16 x 36 x 71.9-72.4	125	225.75	29.50	\$1486	\$1535	\$1195	N/A
Z30S7SH	16 x 30 x 71.9-72.4	125	195.30	25	\$1306	\$1339	\$1034	N/A

Laminate doors are standard. **Includes four 3-position fixed/height adjustable shelves.** Standard with lock.

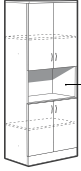

Glazed door option

* Accepts collator 11" high

Storage Cabinet with Doors and Cavity

Z36L7SHC	24 x 36 x 71.9-72.4	125	286.85	43.25	\$1854	\$1912	\$1332	N/A
Z30L7SHC	24 x 30 x 71.9-72.4	125	247.27	36.25	\$1648	\$1698	\$1167	N/A
Z36M7SHC	20 x 36 x 71.9-72.4	125	254.34	36.75	\$1727	\$1777	\$1332	N/A
Z30M7SHC	20 x 30 x 71.9-72.4	125	219.30	30.50	\$1527	\$1569	\$1167	N/A
Z36S7SHC	16 x 36 x 71.9-72.4	125	218.67	29.50	\$1556	\$1605	\$1332	N/A
Z30S7SHC	16 x 30 x 71.9-72.4	125	189.23	25	\$1396	\$1429	\$1167	N/A

Laminate doors are standard. **Includes two 3-position fixed/height adjustable shelves.** Upper and lower locks secure both compartments.



Glazed door option

Storage Cabinet with Door - LEFT

Z21L7SHL	24 x 21 x 71.9-72.4	125	196.35	26	\$1290	\$1331	\$663	N/A
Z18L7SHL	24 x 18 x 71.9-72.4	125	178.50	22.75	\$1203	\$1237	\$595	N/A
Z16L7SHL	24 x 16 x 71.9-72.4	100	166.95	20.75	\$1130	\$1164	\$590	N/A
Z15L7SHL	24 x 15 x 71.9-72.4	100	160.65	19.25	\$1081	\$1109	\$512	N/A
Z12L7SHL	24 x 12 x 71.9-72.4	100	136.50	16	\$993	\$1018	\$460	N/A
Z21M7SHL	20 x 21 x 71.9-72.4	100	174.30	21.25	\$1154	\$1187	\$663	N/A
Z18M7SHL	20 x 18 x 71.9-72.4	100	156.45	19.25	\$1101	\$1131	\$595	N/A
Z16M7SHL	20 x 16 x 71.9-72.4	100	147	17.50	\$1034	\$1063	\$590	N/A
Z15M7SHL	20 x 15 x 71.9-72.4	100	139.65	16.25	\$986	\$1009	\$512	N/A
Z12M7SHL	20 x 12 x 71.9-72.4	100	123.90	13.25	\$905	\$925	\$460	N/A
Z21S7SHL	16 x 21 x 71.9-72.4	100	150.15	18	\$1064	\$1092	\$663	N/A
Z18S7SHL	16 x 18 x 71.9-72.4	100	134.40	15.50	\$989	\$1018	\$595	N/A
Z16S7SHL	16 x 16 x 71.9-72.4	100	124.95	14	\$948	\$976	\$590	N/A
Z15S7SHL	16 x 15 x 71.9-72.4	100	118.65	12.50	\$912	\$934	\$512	N/A
Z12S7SHL	16 x 12 x 71.9-72.4	100	103.95	11	\$801	\$821	\$460	N/A

Laminate doors are standard. **Includes four 3-position fixed/height adjustable shelves.** Standard with lock.



Glazed door option

Storage Cabinet with Door - RIGHT

Z21L7SHR	24 x 21 x 71.9-72.4	125	196.35	26	\$1290	\$1331	\$663	N/A
Z18L7SHR	24 x 18 x 71.9-72.4	125	178.50	22.75	\$1203	\$1237	\$595	N/A
Z16L7SHR	24 x 16 x 71.9-72.4	100	166.95	20.75	\$1130	\$1164	\$590	N/A
Z15L7SHR	24 x 15 x 71.9-72.4	100	160.65	19.25	\$1081	\$1109	\$512	N/A
Z12L7SHR	24 x 12 x 71.9-72.4	100	136.50	16	\$993	\$1018	\$460	N/A
Z21M7SHR	20 x 21 x 71.9-72.4	100	174.30	21.25	\$1154	\$1187	\$663	N/A
Z18M7SHR	20 x 18 x 71.9-72.4	100	156.45	19.25	\$1101	\$1131	\$595	N/A
Z16M7SHR	20 x 16 x 71.9-72.4	100	147	17.50	\$1034	\$1063	\$590	N/A
Z15M7SHR	20 x 15 x 71.9-72.4	100	139.65	16.25	\$986	\$1009	\$512	N/A
Z12M7SHR	20 x 12 x 71.9-72.4	100	123.90	13.25	\$905	\$925	\$460	N/A
Z21S7SHR	16 x 21 x 71.9-72.4	100	150.15	18	\$1064	\$1092	\$663	N/A
Z18S7SHR	16 x 18 x 71.9-72.4	100	134.40	15.50	\$989	\$1018	\$595	N/A
Z16S7SHR	16 x 16 x 71.9-72.4	100	124.95	14	\$948	\$976	\$590	N/A
Z15S7SHR	16 x 15 x 71.9-72.4	100	118.65	12.50	\$912	\$934	\$512	N/A
Z12S7SHR	16 x 12 x 71.9-72.4	100	103.95	11	\$801	\$821	\$460	N/A

Laminate doors are standard. **Includes four 3-position fixed/height adjustable shelves.** Standard with lock.

Required Specifications

Finishes
Top/Edge Detail
Handles

Optional Specifications

Glazing - Doors
Collator (Open Shelves)

STORAGE MODULES - 71.5" / 72" HIGH

MODEL#	DIMENSIONS	FREIGHT CLASS	WT/LBS.	CUBIC FT.	1" TOP	1.5" TOP	GLAZE ADD	HP ADD
--------	------------	---------------	---------	-----------	--------	----------	-----------	--------

D x W x H

Z21L7SHCL	24 x 21 x 71.9-72.4	125	193.67	26	\$1328	\$1369	\$732	N/A
Z18L7SHCL	24 x 18 x 71.9-72.4	125	175.45	22.75	\$1242	\$1276	\$661	N/A
Z16L7SHCL	24 x 16 x 71.9-72.4	125	163.66	20.75	\$1167	\$1200	\$651	N/A
Z15L7SHCL	24 x 15 x 71.9-72.4	100	157.23	19.25	\$1120	\$1148	\$578	N/A
Z12L7SHCL	24 x 12 x 71.9-72.4	100	133.77	16	\$998	\$1021	\$523	N/A
Z21M7SHCL	20 x 21 x 71.9-72.4	100	170.41	21.25	\$1191	\$1225	\$732	N/A
Z18M7SHCL	20 x 18 x 71.9-72.4	125	153.42	19.25	\$1140	\$1169	\$661	N/A
Z16M7SHCL	20 x 16 x 71.9-72.4	100	143.84	17.50	\$1070	\$1099	\$651	N/A
Z15M7SHCL	20 x 15 x 71.9-72.4	100	137.47	16.25	\$1023	\$1048	\$578	N/A
Z12M7SHCL	20 x 12 x 71.9-72.4	100	121.53	13.25	\$950	\$970	\$523	N/A
Z21S7SHCL	16 x 21 x 71.9-72.4	100	146.11	18	\$1103	\$1130	\$732	N/A
Z18S7SHCL	16 x 18 x 71.9-72.4	100	131.39	15.50	\$1028	\$1057	\$661	N/A
Z16S7SHCL	16 x 16 x 71.9-72.4	100	121.92	14	\$984	\$1012	\$651	N/A
Z15S7SHCL	16 x 15 x 71.9-72.4	100	115.61	12.50	\$951	\$973	\$578	N/A
Z12S7SHCL	16 x 12 x 71.9-72.4	100	101.94	11	\$847	\$867	\$523	N/A

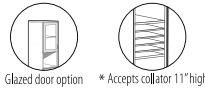
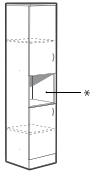

Storage Cabinet with Doors and Cavity - LEFT

Laminate doors are standard. Includes two adjustable shelves. Upper and lower locks secure both compartments

Z21L7SHCR	24 x 21 x 71.9-72.4	125	193.67	26	\$1328	\$1369	\$732	N/A
Z18L7SHCR	24 x 18 x 71.9-72.4	125	175.45	22.75	\$1242	\$1276	\$661	N/A
Z16L7SHCR	24 x 16 x 71.9-72.4	125	163.66	20.75	\$1167	\$1200	\$651	N/A
Z15L7SHCR	24 x 15 x 71.9-72.4	100	157.23	19.25	\$1120	\$1148	\$578	N/A
Z12L7SHCR	24 x 12 x 71.9-72.4	100	133.77	16	\$998	\$1021	\$523	N/A
Z21M7SHCR	20 x 21 x 71.9-72.4	100	170.41	21.25	\$1191	\$1225	\$732	N/A
Z18M7SHCR	20 x 18 x 71.9-72.4	125	153.42	19.25	\$1140	\$1169	\$661	N/A
Z16M7SHCR	20 x 16 x 71.9-72.4	100	143.84	17.50	\$1070	\$1099	\$651	N/A
Z15M7SHCR	20 x 15 x 71.9-72.4	100	137.47	16.25	\$1023	\$1048	\$578	N/A
Z12M7SHCR	20 x 12 x 71.9-72.4	100	121.53	13.25	\$950	\$970	\$523	N/A
Z21S7SHCR	16 x 21 x 71.9-72.4	100	146.11	18	\$1103	\$1130	\$732	N/A
Z18S7SHCR	16 x 18 x 71.9-72.4	100	131.39	15.50	\$1028	\$1057	\$661	N/A
Z16S7SHCR	16 x 16 x 71.9-72.4	100	121.92	14	\$984	\$1012	\$651	N/A
Z15S7SHCR	16 x 15 x 71.9-72.4	100	115.61	12.50	\$951	\$973	\$578	N/A
Z12S7SHCR	16 x 12 x 71.9-72.4	100	101.94	11	\$847	\$867	\$523	N/A

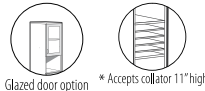
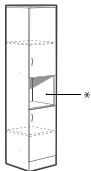

Storage Cabinet with Doors and Cavity - RIGHT

Laminate doors are standard. Includes two adjustable shelves. Upper and lower locks secure both compartments

Z36L7SHN	24 x 36 x 71.9-72.4	150	249.61	43.25	\$1394	\$1452	N/A	N/A
Z30L7SHN	24 x 30 x 71.9-72.4	150	216.23	36.25	\$1236	\$1286	N/A	N/A
Z21L7SHN	24 x 21 x 71.9-72.4	125	171.94	26	\$1071	\$1112	N/A	N/A
Z18L7SHN	24 x 18 x 71.9-72.4	125	156.83	22.75	\$1006	\$1040	N/A	N/A
Z16L7SHN	24 x 16 x 71.9-72.4	125	147.10	20.75	\$934	\$967	N/A	N/A
Z15L7SHN	24 x 15 x 71.9-72.4	125	141.72	19.25	\$907	\$935	N/A	N/A
Z12L7SHN	24 x 12 x 71.9-72.4	125	121.35	16	\$839	\$926	N/A	N/A
Z36M7SHN	20 x 36 x 71.9-72.4	150	217.09	36.75	\$1266	\$1316	N/A	N/A
Z30M7SHN	20 x 30 x 71.9-72.4	125	188.26	30.50	\$1114	\$1157	N/A	N/A
Z21M7SHN	20 x 21 x 71.9-72.4	125	148.69	21.25	\$847	\$880	N/A	N/A
Z18M7SHN	20 x 18 x 71.9-72.4	125	134.80	19.25	\$902	\$932	N/A	N/A
Z16M7SHN	20 x 16 x 71.9-72.4	125	127.29	17.50	\$836	\$865	N/A	N/A
Z15M7SHN	20 x 15 x 71.9-72.4	125	121.96	16.25	\$812	\$837	N/A	N/A
Z12M7SHN	20 x 12 x 71.9-72.4	100	109.11	13.25	\$750	\$770	N/A	N/A
Z36S7SHN	16 x 36 x 71.9-72.4	125	181.43	29.50	\$1095	\$1145	N/A	N/A
Z30S7SHN	16 x 30 x 71.9-72.4	125	158.19	25	\$984	\$1017	N/A	N/A
Z21S7SHN	16 x 21 x 71.9-72.4	125	124.38	18	\$845	\$872	N/A	N/A
Z18S7SHN	16 x 18 x 71.9-72.4	125	112.77	15.50	\$792	\$821	N/A	N/A
Z16S7SHN	16 x 16 x 71.9-72.4	125	105.37	14	\$750	\$778	N/A	N/A
Z15S7SHN	16 x 15 x 71.9-72.4	100	100.10	12.50	\$740	\$762	N/A	N/A
Z12S7SHN	16 x 12 x 71.9-72.4	100	89.53	11	\$646	\$666	N/A	N/A

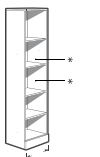
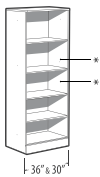

Open Storage Cabinet

Four adjustable shelves.

Required Specifications

- Top finish
- Base finish
- Top/edge detail
- Handles

Optional Specifications

- Glazing - Doors
- Collator (Open Shelves)

STORAGE MODULES - 71.5" / 72" HIGH

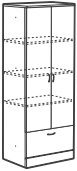

File Module with Doors

MODEL#	DIMENSIONS D x W x H	FREIGHT CLASS	WT./LBS.	CUBIC FT.	1" TOP	1.5" TOP	GLAZE ADD	HP ADD
Z36L7F	24 x 36 x 71.9-72.4	125	310.80	43.25	\$2090	\$2148	\$1112	N/A
Z30L7F	24 x 30 x 71.9-72.4	125	270.90	36.25	\$1867	\$1917	\$964	N/A
Z36M7F	20 x 36 x 71.9-72.4	125	279.30	36.75	\$1960	\$2010	\$1112	N/A
Z30M7F	20 x 30 x 71.9-72.4	100	244.65	30.50	\$1750	\$1793	\$964	N/A
Z36S7F	16 x 36 x 71.9-72.4	100	239.40	29.50	\$1760	\$1809	\$1112	N/A
Z30S7F	16 x 30 x 71.9-72.4	100	207.90	25	\$1577	\$1610	\$964	N/A

One lateral file drawer. Laminate doors are standard. **Includes three adjustable shelves.** Upper lock secures storage compartment. Lower lock secures one file drawer. Front-to-back and side-to-side letter/legal filing capability. Side-to-side file bars included.

- Lateral file drawer construction is for accommodating hanging files NOT for stacking materials on the drawer bottom.



File Module with Door - LEFT

Z16L7FL	24 x 16 x 71.9-72.4	100	178.50	20.75	\$1277	\$1310	\$535	N/A
Z15L7FL	24 x 15 x 71.9-72.4	100	171.15	19.25	\$1199	\$1227	\$464	N/A
Z16M7FL	20 x 16 x 71.9-72.4	100	157.50	17.50	\$1179	\$1208	\$535	N/A
Z15M7FL	20 x 15 x 71.9-72.4	100	151.20	16.25	\$1127	\$1152	\$464	N/A
Z16S7FL	16 x 16 x 71.9-72.4	100	132.30	14	\$1085	\$1113	\$535	N/A
Z15S7FL	16 x 15 x 71.9-72.4	92.5	127.05	12.50	\$1053	\$1076	\$464	N/A

One file drawer. Laminate door is standard. **Includes three adjustable shelves.** Upper lock secures storage compartment. Lower lock secures one file drawer.



File Module with Door - RIGHT

Z16L7FR	24 x 16 x 71.9-72.4	100	178.50	20.75	\$1277	\$1310	\$535	N/A
Z15L7FR	24 x 15 x 71.9-72.4	100	171.15	19.25	\$1199	\$1227	\$464	N/A
Z16M7FR	20 x 16 x 71.9-72.4	100	157.50	17.50	\$1179	\$1208	\$535	N/A
Z15M7FR	20 x 15 x 71.9-72.4	100	151.20	16.25	\$1127	\$1152	\$464	N/A
Z16S7FR	16 x 16 x 71.9-72.4	100	132.30	14	\$1085	\$1113	\$535	N/A
Z15S7FR	16 x 15 x 71.9-72.4	92.5	127.05	12.50	\$1053	\$1076	\$464	N/A

One file drawer. Laminate door is standard. **Includes three adjustable shelves.** Upper lock secures storage compartment. Lower lock secures one file drawer.

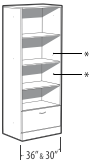

* Accepts collator 11" high

File Module with Open Shelves

Z36L7FN	24 x 36 x 71.9-72.4	125	275.44	43.25	\$1729	\$1786	N/A	N/A
Z30L7FN	24 x 30 x 71.9-72.4	125	240.73	36.25	\$1552	\$1602	N/A	N/A
Z16L7FN	24 x 16 x 71.9-72.4	125	162.20	20.75	\$1091	\$1124	N/A	N/A
Z15L7FN	24 x 15 x 71.9-72.4	100	155.54	19.25	\$1025	\$1053	N/A	N/A
Z36M7FN	20 x 36 x 71.9-72.4	125	242.92	36.75	\$1595	\$1645	N/A	N/A
Z30M7FN	20 x 30 x 71.9-72.4	125	213.81	30.50	\$1435	\$1477	N/A	N/A
Z16M7FN	20 x 16 x 71.9-72.4	100	141.33	17.50	\$995	\$1024	N/A	N/A
Z15M7FN	20 x 15 x 71.9-72.4	100	136.83	16.25	\$953	\$978	N/A	N/A
Z36S7FN	16 x 36 x 71.9-72.4	125	203.06	29.50	\$1399	\$1448	N/A	N/A
Z30S7FN	16 x 30 x 71.9-72.4	125	177.44	25	\$1260	\$1293	N/A	N/A
Z16S7FN	16 x 16 x 71.9-72.4	100	116.27	14	\$902	\$930	N/A	N/A
Z15S7FN	16 x 15 x 71.9-72.4	100	111.82	12.50	\$892	\$914	N/A	N/A

Four open shelves and one file drawer on bottom. **Includes three adjustable shelves.** Lock secures file drawer. 36" and 30" wide models have front-to-back and side-to-side letter/legal filing capability. Side-to-side file bars included.

- Lateral file drawer construction is for accommodating hanging files NOT for stacking materials on the drawer bottom.

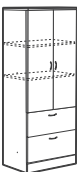

Two File Module with Doors

Z36L7E	24 x 36 x 71.9-72.4	125	316.05	43.25	\$2277	\$2334	\$941	N/A
Z30L7E	24 x 30 x 71.9-72.4	125	276.15	36.25	\$2080	\$2130	\$819	N/A
Z36M7E	20 x 36 x 71.9-72.4	125	285.60	36.75	\$2155	\$2205	\$941	N/A
Z30M7E	20 x 30 x 71.9-72.4	100	249.90	30.50	\$1965	\$2008	\$819	N/A
Z36S7E	16 x 36 x 71.9-72.4	100	244.65	29.50	\$1970	\$2020	\$941	N/A
Z30S7E	16 x 30 x 71.9-72.4	100	213.15	25	\$1776	\$1809	\$819	N/A

Two lateral file drawers. Laminate doors are standard. **Includes two adjustable shelves.** Upper lock secures storage compartment. Lower lock secures two file drawers. Front-to-back and side-to-side letter/legal filing capability. Side-to-side file bars included.

- Lateral file drawer construction is for accommodating hanging files NOT for stacking materials on the drawer bottom.

Required Specifications

Top finish
Base finish
Top/Edge Detail
Handles

Optional Specifications

Glazing - Doors
Collator (Open Shelves)
Box Drawer Option (no upcharge)

STORAGE MODULES - 71.5" / 72" HIGH



Glazed door option

Two File Module with Door - LEFT

MODEL#	DIMENSIONS D x W x H	FREIGHT CLASS	WT/LBS.	CUBIC FT.	1" TOP	1.5" TOP	GLAZE ADD	HP ADD
Z16L7EL	24 x 16 x 71.9-72.4	100	181.65	20.75	\$1343	\$1377	\$463	N/A
Z15L7EL	24 x 15 x 71.9-72.4	100	176.40	19.25	\$1290	\$1318	\$406	N/A
Z16M7EL	20 x 16 x 71.9-72.4	100	162.75	17.50	\$1248	\$1277	\$463	N/A
Z15M7EL	20 x 15 x 71.9-72.4	100	155.40	16.25	\$1198	\$1223	\$406	N/A
Z16S7EL	16 x 16 x 71.9-72.4	100	137.55	14	\$1161	\$1189	\$463	N/A
Z15S7EL	16 x 15 x 71.9-72.4	92.5	132.30	12.50	\$1135	\$1157	\$406	N/A

Two file drawers on bottom. Laminate door is standard. **Includes two 3-position fixed/height adjustable shelves.** Upper lock secures storage compartment. Lower lock secures two file drawers.



Glazed door option

Two File Module with Door - RIGHT

Z16L7ER	24 x 16 x 71.9-72.4	100	181.65	20.75	\$1343	\$1377	\$463	N/A
Z15L7ER	24 x 15 x 71.9-72.4	100	176.40	19.25	\$1290	\$1318	\$406	N/A
Z16M7ER	20 x 16 x 71.9-72.4	100	162.75	17.50	\$1248	\$1277	\$463	N/A
Z15M7ER	20 x 15 x 71.9-72.4	100	155.40	16.25	\$1198	\$1223	\$406	N/A
Z16S7ER	16 x 16 x 71.9-72.4	100	137.55	14	\$1161	\$1189	\$463	N/A
Z15S7ER	16 x 15 x 71.9-72.4	92.5	132.30	12.50	\$1135	\$1157	\$406	N/A

Two file drawers on bottom. Laminate door is standard. **Includes two 3-position fixed/height adjustable shelves.** Upper lock secures storage compartment. Lower lock secures two file drawers.



Glazed door option



* Accepts collator 11" high

Two File Module with Doors and Cavity

Z36L7EC	24 x 36 x 71.9-72.4	125	307.85	43.25	\$2231	\$2288	\$740	N/A
Z30L7EC	24 x 30 x 71.9-72.4	125	270.37	36.25	\$2042	\$2092	\$644	N/A
Z36M7EC	20 x 36 x 71.9-72.4	125	278.49	36.75	\$2110	\$2160	\$740	N/A
Z30M7EC	20 x 30 x 71.9-72.4	125	243.45	30.50	\$1928	\$1971	\$644	N/A
Z36S7EC	16 x 36 x 71.9-72.4	100	237.57	29.50	\$1790	\$1839	\$740	N/A
Z30S7EC	16 x 30 x 71.9-72.4	100	207.08	25	\$1603	\$1636	\$644	N/A

Two lateral file drawers on bottom. Laminate doors are standard. **Includes one 3-position fixed/height adjustable shelf.** Upper lock secures storage compartment. Lower lock secures all drawers. Front-to-back and side-to-side letter/legal filing capability. Side-to-side file bars included.

- Lateral file drawer construction is for accommodating hanging files NOT for stacking materials on the drawer bottom.

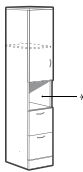

Glazed door option



* Accepts collator 11" high

Two File Module with Doors Cavity - LEFT

Z16L7ECL	24 x 16 x 71.9-72.4	100	178.36	20.75	\$1320	\$1354	\$365	N/A
Z15L7ECL	24 x 15 x 71.9-72.4	100	172.98	19.25	\$1273	\$1301	\$322	N/A
Z16M7ECL	20 x 16 x 71.9-72.4	100	159.59	17.50	\$1214	\$1243	\$365	N/A
Z15M7ECL	20 x 15 x 71.9-72.4	100	153.22	16.25	\$1171	\$1194	\$322	N/A
Z16S7ECL	16 x 16 x 71.9-72.4	100	134.52	14	\$1138	\$1166	\$365	N/A
Z15S7ECL	16 x 15 x 71.9-72.4	92.5	129.26	12.50	\$1115	\$1138	\$322	N/A

Two lateral file drawers on bottom. Laminate doors are standard. **Includes one 3-position fixed/height adjustable shelf.** Upper lock secures storage compartment. Lower lock secures all drawers.

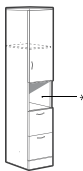

Glazed door option



* Accepts collator 11" high

Two File Module with Doors Cavity - RIGHT

Z16L7ECR	24 x 16 x 71.9-72.4	100	178.36	20.75	\$1320	\$1354	\$365	N/A
Z15L7ECR	24 x 15 x 71.9-72.4	100	172.98	19.25	\$1273	\$1301	\$322	N/A
Z16M7ECR	20 x 16 x 71.9-72.4	100	159.59	17.50	\$1214	\$1243	\$365	N/A
Z15M7ECR	20 x 15 x 71.9-72.4	100	153.22	16.25	\$1171	\$1194	\$322	N/A
Z16S7ECR	16 x 16 x 71.9-72.4	100	134.52	14	\$1138	\$1166	\$365	N/A
Z15S7ECR	16 x 15 x 71.9-72.4	92.5	129.26	12.50	\$1115	\$1138	\$322	N/A

Two lateral file drawers on bottom. Laminate doors are standard. **Includes one 3-position fixed/height adjustable shelf.** Upper lock secures storage compartment. Lower lock secures all drawers.

Required Specifications

Top finish
Base finish
Top/Edge Detail
Handles

Optional Specifications

Glazing - Doors
Collator (Open Shelves)
Box Drawer Option (no upcharge)

STORAGE MODULES - 71.5" / 72" HIGH

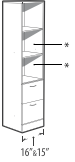
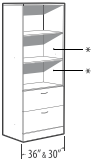

* Accepts collator 11" high

Two File Module with Open Shelves

MODEL#	DIMENSIONS D x W x H	FREIGHT CLASS	WT./LBS.	CUBIC FT.	1" TOP	1.5" TOP	GLAZE ADD	HP ADD
Z36L7EN	24 x 36 x 71.9-72.4	125	286.57	43.25	\$1977	\$2035	N/A	N/A
Z30L7EN	24 x 30 x 71.9-72.4	125	252.63	36.25	\$1819	\$1869	N/A	N/A
Z16L7EN	24 x 16 x 71.9-72.4	100	168.90	20.75	\$1192	\$1225	N/A	N/A
Z15L7EN	24 x 15 x 71.9-72.4	100	164.12	19.25	\$1157	\$1185	N/A	N/A
Z36M7EN	20 x 36 x 71.9-72.4	125	257.21	36.75	\$1858	\$1909	N/A	N/A
Z30M7EN	20 x 30 x 71.9-72.4	125	225.71	30.50	\$1704	\$1747	N/A	N/A
Z16M7EN	20 x 16 x 71.9-72.4	100	150.13	17.50	\$1096	\$1125	N/A	N/A
Z15M7EN	20 x 15 x 71.9-72.4	100	144.36	16.25	\$1066	\$1089	N/A	N/A
Z36S7EN	16 x 36 x 71.9-72.4	125	216.29	29.50	\$1672	\$1721	N/A	N/A
Z30S7EN	16 x 30 x 71.9-72.4	125	189.34	25	\$1515	\$1548	N/A	N/A
Z16S7EN	16 x 16 x 71.9-72.4	100	125.06	14	\$1011	\$1039	N/A	N/A
Z15S7EN	16 x 15 x 71.9-72.4	100	120.40	12.50	\$1001	\$1024	N/A	N/A

Three open shelves and two file drawers on bottom. **Includes two 3-position fixed/height adjustable shelves.** Lock secures all drawers. 36" and 30" wide models have front-to-back and side-to-side letter/legal filing capability. Side-to-side file bars included.

- Lateral file drawer construction is for accommodating hanging files NOT for stacking materials on the drawer bottom.



Glazed door option

Three File Module with Doors

Z36L73F	24 x 36 x 71.9-72.4	125	320.25	43.25	\$2494	\$2552	\$740	N/A
Z30L73F	24 x 30 x 71.9-72.4	125	283.50	36.25	\$2286	\$2335	\$644	N/A
Z36M73F	20 x 36 x 71.9-72.4	125	290.85	36.75	\$2389	\$2439	\$740	N/A
Z30M73F	20 x 30 x 71.9-72.4	100	259.35	30.50	\$2181	\$2224	\$644	N/A
Z36S73F	16 x 36 x 71.9-72.4	100	248.85	29.50	\$2165	\$2214	\$740	N/A
Z30S73F	16 x 30 x 71.9-72.4	100	218.40	25	\$1964	\$1997	\$644	N/A

Three lateral file drawers on bottom. Laminate doors are standard. **Includes one 3-position fixed/height adjustable shelf.** Upper lock secures storage compartment. Lower lock secures three file drawers. Front-to-back and side-to-side letter/legal filing capability. Side-to-side file bars included.

- Lateral file drawer construction is for accommodating hanging files NOT for stacking materials on the drawer bottom.



Glazed door option

Three File Module with Door - LEFT

Z16L73FL	24 x 16 x 71.9-72.4	100	187.95	20.75	\$1453	\$1486	\$365	N/A
Z15L73FL	24 x 15 x 71.9-72.4	100	182	19.25	\$1404	\$1432	\$322	N/A
Z16M73FL	20 x 16 x 71.9-72.4	100	169.05	17.50	\$1364	\$1393	\$365	N/A
Z15M73FL	20 x 15 x 71.9-72.4	100	161.70	16.25	\$1321	\$1344	\$322	N/A
Z16S73FL	16 x 16 x 71.9-72.4	92.5	142.80	14	\$1273	\$1301	\$365	N/A
Z15S73FL	16 x 15 x 71.9-72.4	92.5	137.55	12.50	\$1240	\$1263	\$322	N/A

Three file drawers on bottom. Laminate door is standard. **Includes one 3-position fixed/height adjustable shelf.** Upper lock secures storage compartment. Lower lock secures three file drawers.



Glazed door option

Three File Module with Door - RIGHT

Z16L73FR	24 x 16 x 71.9-72.4	100	187.95	20.75	\$1453	\$1486	\$365	N/A
Z15L73FR	24 x 15 x 71.9-72.4	100	182	19.25	\$1404	\$1432	\$322	N/A
Z16M73FR	20 x 16 x 71.9-72.4	100	169.05	17.50	\$1364	\$1393	\$365	N/A
Z15M73FR	20 x 15 x 71.9-72.4	100	161.70	16.25	\$1321	\$1344	\$322	N/A
Z16S73FR	16 x 16 x 71.9-72.4	92.5	142.80	14	\$1273	\$1301	\$365	N/A
Z15S73FR	16 x 15 x 71.9-72.4	92.5	137.55	12.50	\$1240	\$1263	\$322	N/A

Three file drawers on bottom. Laminate door is standard. **Includes one 3-position fixed/height adjustable shelf.** Upper lock secures storage compartment. Lower lock secures three file drawers.

Required Specifications

- Top finish
- Base finish
- Top/Edge Detail
- Handles

Optional Specifications

- Glazing - Doors
- Collator (Open Shelves)
- Box Drawer Option (no upcharge)

STORAGE MODULES - 71.5" / 72" HIGH

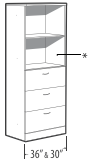

* Accepts collator 11" high

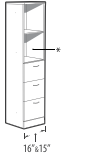

Glazed door option

Three File Module with Open Shelves

MODEL#	DIMENSIONS D x W x H	FREIGHT CLASS	WT/LBS.	CUBIC FT.	1" TOP	1.5" TOP	GLAZE ADD	HP ADD
Z36L73FN	24 x 36 x 71.9-72.4	125	298.75	43.25	\$2243	\$2300	N/A	N/A
Z30L73FN	24 x 30 x 71.9-72.4	125	266.63	36.25	\$2063	\$2113	N/A	N/A
Z16L73FN	24 x 16 x 71.9-72.4	100	178.75	20.75	\$1324	\$1358	N/A	N/A
Z15L73FN	24 x 15 x 71.9-72.4	100	172.69	19.25	\$1290	\$1318	N/A	N/A
Z36M73FN	20 x 36 x 71.9-72.4	125	270.44	36.75	\$2137	\$2187	N/A	N/A
Z30M73FN	20 x 30 x 71.9-72.4	125	241.81	30.50	\$1960	\$2002	N/A	N/A
Z16M73FN	20 x 16 x 71.9-72.4	100	159.98	17.50	\$1236	\$1265	N/A	N/A
Z15M73FN	20 x 15 x 71.9-72.4	100	153.98	16.25	\$1207	\$1230	N/A	N/A
Z36S73FN	16 x 36 x 71.9-72.4	125	228.47	29.50	\$1908	\$1958	N/A	N/A
Z30S73FN	16 x 30 x 71.9-72.4	100	201.24	25	\$1739	\$1772	N/A	N/A
Z16S73FN	16 x 16 x 71.9-72.4	100	133.86	14	\$1144	\$1172	N/A	N/A
Z15S73FN	16 x 15 x 71.9-72.4	92.5	128.97	12.50	\$1124	\$1147	N/A	N/A

Two open shelves and three file drawers on bottom. **Includes one 3-position fixed/height adjustable shelf.** Lock secures all drawers. 36" and 30" wide models have front-to-back and side-to-side letter/legal filing capability. Side-to-side file bars included.

- Lateral file drawer construction is for accommodating hanging files NOT for stacking materials on the drawer bottom.

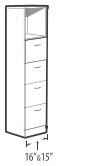
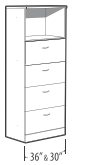

Four File Module with Open Shelf

Z36L74FN	24 x 36 x 71.9-72.4	125	310.80	43.25	\$2673	\$2731	N/A	N/A
Z30L74FN	24 x 30 x 71.9-72.4	125	277.20	36.25	\$2499	\$2549	N/A	N/A
Z16L74FN	24 x 16 x 71.9-72.4	100	186.90	20.75	\$1427	\$1460	N/A	N/A
Z15L74FN	24 x 15 x 71.9-72.4	100	180.60	19.25	\$1389	\$1416	N/A	N/A
Z36M74FN	20 x 36 x 71.9-72.4	125	283.50	36.75	\$2388	\$2438	N/A	N/A
Z30M74FN	20 x 30 x 71.9-72.4	100	255.15	30.50	\$2245	\$2287	N/A	N/A
Z16M74FN	20 x 16 x 71.9-72.4	100	169.05	17.50	\$1343	\$1372	N/A	N/A
Z15M74FN	20 x 15 x 71.9-72.4	100	161.70	16.25	\$1301	\$1324	N/A	N/A
Z36S74FN	16 x 36 x 71.9-72.4	100	239.40	29.50	\$2139	\$2188	N/A	N/A
Z30S74FN	16 x 30 x 71.9-72.4	100	212.10	25	\$1949	\$1982	N/A	N/A
Z16S74FN	16 x 16 x 71.9-72.4	92.5	140.70	14	\$1234	\$1262	N/A	N/A
Z15S74FN	16 x 15 x 71.9-72.4	92.5	135.45	12.50	\$1185	\$1208	N/A	N/A

Open shelf and four file drawers. Lock secures all drawers. 36" and 30" wide models have front-to-back and side-to-side letter/legal filing capability. Side-to-side file bars included.

- Lateral file drawer construction is for accommodating hanging files NOT for stacking materials on the drawer bottom.

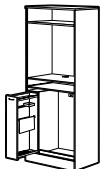

Intended for working while standing

Media Center - LEFT

Z36L7MCL	24 x 36 x 71.9-72.4	125	294	43.25	\$2075	\$2132	N/A	N/A
Z30L7MCL	24 x 30 x 71.9-72.4	125	259.35	36.25	\$1891	\$1941	N/A	N/A
Z36M7MCL	20 x 36 x 71.9-72.4	125	261.45	36.75	\$1933	\$1983	N/A	N/A
Z30M7MCL	20 x 30 x 71.9-72.4	125	229.95	30.50	\$1760	\$1803	N/A	N/A
Z36S7MCL	16 x 36 x 71.9-72.4	125	214.20	29.50	\$1701	\$1750	N/A	N/A
Z30S7MCL	16 x 30 x 71.9-72.4	125	189	25	\$1540	\$1573	N/A	N/A

Unit, accommodates pc, keyboard, monitor, hanging folders and accessories and/or printer. One vertical drawer on the **left**. Pull out keyboard shelf. Adjustable pull out bottom shelf accommodates pc and/or printer. **Includes one 3-position fixed/height adjustable shelf.** Grommet in worksurface and back panel. Lock secures vertical drawer.

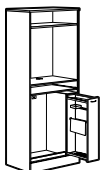

Intended for working while standing

Media Center - RIGHT

Z36L7MCR	24 x 36 x 71.9-72.4	125	294	43.25	\$2075	\$2132	N/A	N/A
Z30L7MCR	24 x 30 x 71.9-72.4	125	259.35	36.25	\$1891	\$1941	N/A	N/A
Z36M7MCR	20 x 36 x 71.9-72.4	125	261.45	36.75	\$1933	\$1983	N/A	N/A
Z30M7MCR	20 x 30 x 71.9-72.4	125	229.95	30.50	\$1760	\$1803	N/A	N/A
Z36S7MCR	16 x 36 x 71.9-72.4	125	214.20	29.50	\$1701	\$1750	N/A	N/A
Z30S7MCR	16 x 30 x 71.9-72.4	125	189	25	\$1540	\$1573	N/A	N/A

Unit, accommodates pc, keyboard, monitor, hanging folders and accessories and/or printer. One vertical drawer on the **right**. Pull out keyboard shelf. Adjustable pull out bottom shelf accommodates pc and/or printer. **Includes one 3-position fixed/height adjustable shelf.** Grommet in worksurface and back panel. Lock secures vertical drawer.

Required Specifications

- Top finish
- Base finish
- Top/Edge Detail
- Handles

Optional Specifications

- Glazing - Doors
- Collator (Open Shelves)
- Box Drawer Option (no upcharge)

STORAGE MODULES - 71.5" / 72" HIGH



Intended for working while standing

PC Center

MODEL#	DIMENSIONS	FREIGHT CLASS	WT/LBS.	CUBIC FT.	1"TOP	1.5" TOP	GLAZE ADD	HP ADD
Z36L7PC	24 x 36 x 71.9-72.4	150	255.15	43.25	\$1530	\$1587	N/A	N/A
Z30L7PC	24 x 30 x 71.9-72.4	125	221.55	36.25	\$1367	\$1417	N/A	N/A
Z36M7PC	20 x 36 x 71.9-72.4	125	226.80	36.75	\$1406	\$1456	N/A	N/A
Z30M7PC	20 x 30 x 71.9-72.4	125	197.40	30.50	\$1234	\$1277	N/A	N/A
Z36S7PC	16 x 36 x 71.9-72.4	125	187.95	29.50	\$1216	\$1265	N/A	N/A
Z30S7PC	16 x 30 x 71.9-72.4	125	162.75	25	\$1119	\$1152	N/A	N/A

Standing height unit, accommodates pc, keyboard, monitor and/or printer. Pull out keyboard shelf. Adjustable pull out bottom shelf accommodates pc and/or printer. **Includes one 3-position fixed/height adjustable shelf.** Grommet in worksurface and back panel.

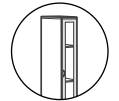
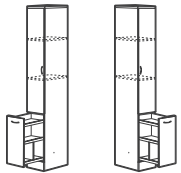

Glazed door option

LEFT RIGHT
Vertical Utility Drawer with Door

Z12L7VDL	24 x 12 x 71.9-72.4	92.5	164.85	16	\$1197	\$1222	\$366	N/A
Z12M7VDL	20 x 12 x 71.9-72.4	92.5	147	13.25	\$1107	\$1127	\$366	N/A
Z12S7VDL	16 x 12 x 71.9-72.4	92.5	123.90	11	\$1013	\$1033	\$366	N/A
Z12L7VDR	24 x 12 x 71.9-72.4	92.5	164.85	16	\$1197	\$1222	\$366	N/A
Z12M7VDR	20 x 12 x 71.9-72.4	92.5	147	13.25	\$1107	\$1127	\$366	N/A
Z12S7VDR	16 x 12 x 71.9-72.4	92.5	123.90	11	\$1013	\$1033	\$366	N/A

Specify **VDL** models for **LEFT** or **VDR** models for **RIGHT**

Laminate doors are standard. **Includes two 3-position fixed/height adjustable shelves** and one vertical drawer. Upper lock secures storage compartment. Lower lock secures vertical drawer.

WARDROBE CABINETS - 71.5" / 72" HIGH

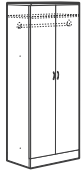

Wardrobe Cabinet

MODEL#	DIMENSIONS	FREIGHT CLASS	WT/LBS.	CUBIC FT.	1"TOP	1.5" TOP	GLAZE ADD	HP ADD
Z36L7WA	24 x 36 x 71.9-72.4	150	252	43.25	\$1622	\$1679	N/A	N/A
Z30L7WA	24 x 30 x 71.9-72.4	125	218.40	36.25	\$1515	\$1565	N/A	N/A
Z36M7WA	20 x 36 x 71.9-72.4	125	226.80	36.75	\$1526	\$1576	N/A	N/A
Z30M7WA	20 x 30 x 71.9-72.4	125	196.35	30.50	\$1354	\$1397	N/A	N/A

Laminate doors are standard. Full length hanging rod included. **Includes one 3-position fixed/height adjustable shelf** above hanging rod. Standard with lock.



Wardrobe Cabinet - LEFT

Z24L7WAL	24 x 24 x 71.9-72.4	125	191.10	29.75	\$1229	\$1270	N/A	N/A
Z21L7WAL	24 x 21 x 71.9-72.4	125	178.50	26	\$1185	\$1226	N/A	N/A
Z18L7WAL	24 x 18 x 71.9-72.4	125	158.55	22.75	\$1089	\$1123	N/A	N/A
Z16L7WAL	24 x 16 x 71.9-72.4	125	149.10	20.75	\$1045	\$1078	N/A	N/A
Z15L7WAL	24 x 15 x 71.9-72.4	125	144.90	19.25	\$994	\$1022	N/A	N/A
Z12L7WAL	24 x 12 x 71.9-72.4	100	130.20	16	\$926	\$949	N/A	N/A
Z24M7WAL	20 x 24 x 71.9-72.4	125	171.15	25.25	\$1137	\$1173	N/A	N/A
Z21M7WAL	20 x 21 x 71.9-72.4	125	154.35	21.25	\$1090	\$1124	N/A	N/A
Z18M7WAL	20 x 18 x 71.9-72.4	125	139.65	19.25	\$1006	\$1035	N/A	N/A
Z16M7WAL	20 x 16 x 71.9-72.4	125	131.25	17.50	\$961	\$990	N/A	N/A
Z15M7WAL	20 x 15 x 71.9-72.4	125	126	16.25	\$912	\$937	N/A	N/A
Z12M7WAL	20 x 12 x 71.9-72.4	100	113.40	13.25	\$855	\$875	N/A	N/A

Laminate doors are standard. Full length hanging rod included. **Includes one 3-position fixed/height adjustable shelf** above hanging rod. Standard with lock.

Required Specifications

- Top finish
- Base finish
- Top/Edge Detail
- Handles

Optional Specifications

- Glazing - Doors (Vertical Utility)

WARDROBE CABINETS - 71.5" / 72" HIGH

MODEL#	DIMENSIONS	FREIGHT CLASS	WT/LBS.	CUBIC FT.	1" TOP	1.5" TOP	GLAZE ADD	HP ADD
D x W x H								
Z24L7WAR	24 x 24 x 71.9-72.4	125	191.10	29.75	\$1229	\$1270	N/A	N/A
Z21L7WAR	24 x 21 x 71.9-72.4	125	178.50	26	\$1185	\$1226	N/A	N/A
Z18L7WAR	24 x 18 x 71.9-72.4	125	158.55	22.75	\$1089	\$1123	N/A	N/A
Z16L7WAR	24 x 16 x 71.9-72.4	125	149.10	20.75	\$1045	\$1078	N/A	N/A
Z15L7WAR	24 x 15 x 71.9-72.4	125	144.90	19.25	\$994	\$1022	N/A	N/A
Z12L7WAR	24 x 12 x 71.9-72.4	100	130.20	16	\$926	\$949	N/A	N/A
Z24M7WAR	20 x 24 x 71.9-72.4	125	171.15	25.25	\$1137	\$1173	N/A	N/A
Z21M7WAR	20 x 21 x 71.9-72.4	125	154.35	21.25	\$1090	\$1124	N/A	N/A
Z18M7WAR	20 x 18 x 71.9-72.4	125	139.65	19.25	\$1006	\$1035	N/A	N/A
Z16M7WAR	20 x 16 x 71.9-72.4	125	131.25	17.50	\$961	\$990	N/A	N/A
Z15M7WAR	20 x 15 x 71.9-72.4	125	126	16.25	\$912	\$937	N/A	N/A
Z12M7WAR	20 x 12 x 71.9-72.4	100	113.40	13.25	\$855	\$875	N/A	N/A

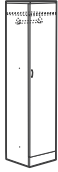

Wardrobe Cabinet - RIGHT

Laminate doors are standard. Full length hanging rod included. **Includes one 3-position fixed/height adjustable shelf** above hanging rod. Standard with lock.

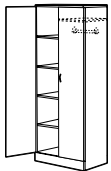

Glazed door option

Wardrobe Cabinet/Shelving Combo with Doors - LEFT

Z36L7DIL	24 x 36 x 71.9-72.4	125	300.30	43.25	\$1913	\$1971	\$1195	N/A
Z30L7DIL	24 x 30 x 71.9-72.4	125	262.50	36.25	\$1672	\$1722	\$1034	N/A
Z24L7DIL	24 x 24 x 71.9-72.4	125	232.05	29.75	\$1521	\$1562	\$931	N/A
Z21L7DIL	24 x 21 x 71.9-72.4	125	200.55	26	\$1476	\$1516	\$923	N/A
Z36M7DIL	20 x 36 x 71.9-72.4	125	276.15	36.75	\$1796	\$1846	\$1195	N/A
Z30M7DIL	20 x 30 x 71.9-72.4	125	241.50	30.50	\$1559	\$1602	\$1034	N/A
Z24M7DIL	20 x 24 x 71.9-72.4	100	214.20	25.25	\$1430	\$1464	\$931	N/A
Z21M7DIL	20 x 21 x 71.9-72.4	100	196.35	21.25	\$1372	\$1406	\$923	N/A

Laminate doors are standard. Storage compartment on **left includes four 3-position fixed/height adjustable shelves**. Wardrobe compartment on **right** includes hanging rod and one adjustable shelf above rod. Single lock secures storage and wardrobe compartments.

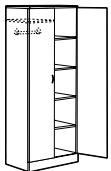

Glazed door option

Wardrobe Cabinet/Shelving Combo with Doors - RIGHT

Z36L7DIR	24 x 36 x 71.9-72.4	125	300.30	43.25	\$1913	\$1971	\$1195	N/A
Z30L7DIR	24 x 30 x 71.9-72.4	125	262.50	36.25	\$1672	\$1722	\$1034	N/A
Z24L7DIR	24 x 24 x 71.9-72.4	125	232.05	29.75	\$1521	\$1562	\$931	N/A
Z21L7DIR	24 x 21 x 71.9-72.4	125	200.55	26	\$1476	\$1516	\$923	N/A
Z36M7DIR	20 x 36 x 71.9-72.4	125	276.15	36.75	\$1796	\$1846	\$1195	N/A
Z30M7DIR	20 x 30 x 71.9-72.4	125	241.50	30.50	\$1559	\$1602	\$1034	N/A
Z24M7DIR	20 x 24 x 71.9-72.4	100	214.20	25.25	\$1430	\$1464	\$931	N/A
Z21M7DIR	20 x 21 x 71.9-72.4	100	196.35	21.25	\$1372	\$1406	\$923	N/A

Laminate doors are standard. Storage compartment on **right includes four 3-position fixed/height adjustable shelves**. Wardrobe compartment on **left** includes hanging rod and one adjustable shelf above rod. Single lock secures storage and wardrobe compartments.

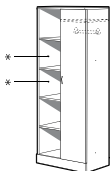

Glazed door option * Accepts collator 11" high

Wardrobe Cabinet/Open Shelving Combo - LEFT

Z36L7DINL	24 x 36 x 71.9-72.4	125	277.47	43.25	\$1726	\$1784	\$596	N/A
Z30L7DINL	24 x 30 x 71.9-72.4	125	244.53	36.25	\$1519	\$1569	\$515	N/A
Z24L7DINL	24 x 24 x 71.9-72.4	125	217.88	29.75	\$1383	\$1424	\$463	N/A
Z21L7DINL	24 x 21 x 71.9-72.4	125	189.33	26	\$1336	\$1377	\$458	N/A
Z36M7DINL	20 x 36 x 71.9-72.4	125	254.41	36.75	\$1608	\$1658	\$596	N/A
Z30M7DINL	20 x 30 x 71.9-72.4	125	222.86	30.50	\$1404	\$1447	\$515	N/A
Z24M7DINL	20 x 24 x 71.9-72.4	100	202.22	25.25	\$1290	\$1324	\$463	N/A
Z21M7DINL	20 x 21 x 71.9-72.4	100	183.93	21.25	\$1234	\$1268	\$458	N/A

Laminate door is standard on wardrobe section. Storage compartment on **left includes four 3-position fixed/height adjustable shelves**. Wardrobe compartment on **right** includes hanging rod and one adjustable shelf above rod. Single lock secures storage and wardrobe compartments.

Required Specifications

Top finish
Base finish
Top/Edge Detail
Handles

Optional Specifications

Glazing - Doors
Collator (Open Shelves)

WARDROBE CABINETS - 71.5" / 72" HIGH

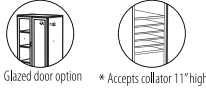
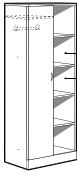

Wardrobe Cabinet/Open Shelving Combo - RIGHT

MODEL#	DIMENSIONS D x W x H	FREIGHT CLASS	WT/LBS.	CUBIC FT.	1" TOP	1.5" TOP	GLAZE ADD	HP ADD
Z36L7DINR	24 x 36 x 71.9-72.4	125	277.47	43.25	\$1726	\$1784	\$596	N/A
Z30L7DINR	24 x 30 x 71.9-72.4	125	244.53	36.25	\$1519	\$1569	\$515	N/A
Z24L7DINR	24 x 24 x 71.9-72.4	125	217.88	29.75	\$1383	\$1424	\$463	N/A
Z21L7DINR	24 x 21 x 71.9-72.4	125	189.33	26	\$1336	\$1377	\$458	N/A
Z36M7DINR	20 x 36 x 71.9-72.4	125	254.41	36.75	\$1608	\$1658	\$596	N/A
Z30M7DINR	20 x 30 x 71.9-72.4	125	222.86	30.50	\$1404	\$1447	\$515	N/A
Z24M7DINR	20 x 24 x 71.9-72.4	100	202.22	25.25	\$1290	\$1324	\$463	N/A
Z21M7DINR	20 x 21 x 71.9-72.4	100	183.93	21.25	\$1234	\$1268	\$458	N/A

Laminate door is standard on wardrobe section. Storage compartment on **right includes four 3-position fixed/height adjustable shelves**. Wardrobe compartment on **left** includes hanging rod and one adjustable shelf above rod. Single lock secures storage and wardrobe compartments.

PERSONAL TOWERS - 71.5" / 72" HIGH

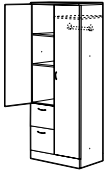

Personal Tower with Doors - LEFT

MODEL#	DIMENSIONS	FREIGHT CLASS	WT/LBS.	CUBIC FT.	1" TOP	1.5" TOP	GLAZE ADD	HP ADD
Z36L7EL	24 x 36 x 71.9-72.4	125	324.45	43.25	\$2096	\$2153	\$1060	N/A
Z30L7EL	24 x 30 x 71.9-72.4	125	289.80	36.25	\$1924	\$1974	\$973	N/A
Z24L7EL	24 x 24 x 71.9-72.4	100	260.76	29.75	\$1832	\$1874	\$861	N/A
Z36M7EL	20 x 36 x 71.9-72.4	125	288.75	36.75	\$1961	\$2012	\$1060	N/A
Z30M7EL	20 x 30 x 71.9-72.4	100	259.35	30.50	\$1798	\$1841	\$973	N/A
Z24M7EL	20 x 24 x 71.9-72.4	100	231.65	25.25	\$1711	\$1745	\$861	N/A

Two file drawers on bottom. Laminate doors are standard. Storage compartment on **left includes two 3-position fixed/height adjustable shelves**. Wardrobe compartment on **right** includes hanging rod and one adjustable shelf above rod. Upper lock secures storage and wardrobe compartments. Lower lock secures all drawers.

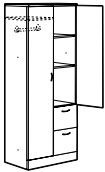

Personal Tower with Doors - RIGHT

Z36L7ER	24 x 36 x 71.9-72.4	125	324.45	43.25	\$2096	\$2153	\$1060	N/A
Z30L7ER	24 x 30 x 71.9-72.4	125	289.80	36.25	\$1924	\$1974	\$973	N/A
Z24L7ER	24 x 24 x 71.9-72.4	100	260.76	29.75	\$1832	\$1874	\$861	N/A
Z36M7ER	20 x 36 x 71.9-72.4	125	288.75	36.75	\$1961	\$2012	\$1060	N/A
Z30M7ER	20 x 30 x 71.9-72.4	100	259.35	30.50	\$1798	\$1841	\$973	N/A
Z24M7ER	20 x 24 x 71.9-72.4	100	231.65	25.25	\$1711	\$1745	\$861	N/A

Two file drawers on bottom. Laminate doors are standard. Storage compartment on **right includes two 3-position fixed/height adjustable shelves**. Wardrobe compartment on **left** includes hanging rod and one adjustable shelf above rod. Upper lock secures storage and wardrobe compartments. Lower lock secures all drawers.

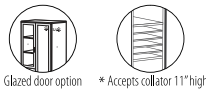
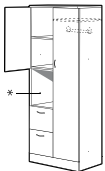

Personal Tower with Doors and cavity - LEFT

Z36L7ECL	24 x 36 x 71.9-72.4	125	320.24	43.25	\$2083	\$2141	\$964	N/A
Z30L7ECL	24 x 30 x 71.9-72.4	125	287.34	36.25	\$1910	\$1960	\$875	N/A
Z24L7ECL	24 x 24 x 71.9-72.4	100	257.23	29.75	\$1812	\$1853	\$763	N/A
Z36M7ECL	20 x 36 x 71.9-72.4	125	285.63	36.75	\$1929	\$1979	\$964	N/A
Z30M7ECL	20 x 30 x 71.9-72.4	100	256.22	30.50	\$1767	\$1809	\$875	N/A
Z24M7ECL	20 x 24 x 71.9-72.4	100	228.11	25.25	\$1679	\$1713	\$763	N/A

Two file drawers on bottom. Laminate doors are standard. Storage compartment on **left includes one 3-position fixed/height adjustable shelf**. Wardrobe compartment on **right** includes hanging rod and one adjustable shelf above rod. Upper lock secures storage and wardrobe compartments. Lower lock secures all drawers.

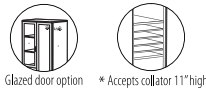
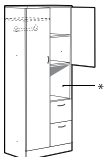

Personal Tower with Doors and cavity - RIGHT

Z36L7ECL	24 x 36 x 71.9-72.4	125	320.24	43.25	\$2083	\$2141	\$964	N/A
Z30L7ECL	24 x 30 x 71.9-72.4	125	287.34	36.25	\$1910	\$1960	\$875	N/A
Z24L7ECL	24 x 24 x 71.9-72.4	100	257.23	29.75	\$1812	\$1853	\$763	N/A
Z36M7ECL	20 x 36 x 71.9-72.4	125	285.63	36.75	\$1929	\$1979	\$964	N/A
Z30M7ECL	20 x 30 x 71.9-72.4	100	256.22	30.50	\$1767	\$1809	\$875	N/A
Z24M7ECL	20 x 24 x 71.9-72.4	100	228.11	25.25	\$1679	\$1713	\$763	N/A

Two file drawers on bottom. Laminate doors are standard. Storage compartment on **left includes one 3-position fixed/height adjustable shelf**. Wardrobe compartment on **right** includes hanging rod and one adjustable shelf above rod. Upper lock secures storage and wardrobe compartments. Lower lock secures all drawers.

Required Specifications

- Top finish
- Base finish
- Top/Edge Detail
- Handles

Optional Specifications

- Glazing - Doors
- Collator (Open Shelves)
- Box Drawer Option (no upcharge)

PERSONAL TOWERS - 71.5" / 72" HIGH

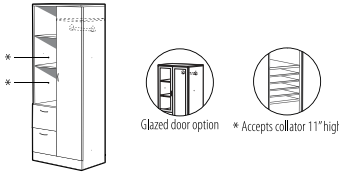

Personal Tower with Open Shelves - LEFT

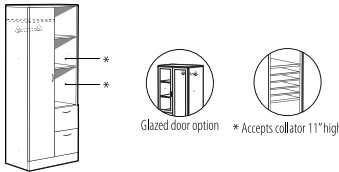

Personal Tower with Open Shelves - RIGHT

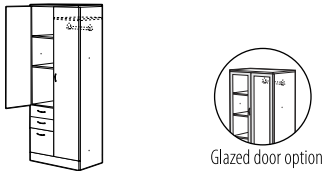

Personal Tower with Doors - LEFT

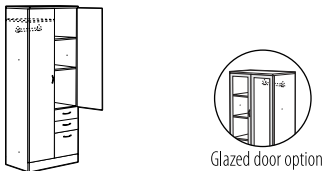

Personal Tower with Doors - RIGHT

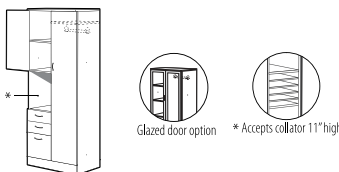

Personal Tower with Doors and Cavity - LEFT

MODEL#	DIMENSIONS D x W x H	FREIGHT CLASS	WT/LBS.	CUBIC FT.	1" TOP	1.5" TOP	GLAZE ADD	HP ADD
Z36L7ENL	24 x 36 x 71.9-72.4	125	309.60	43.25	\$1979	\$2037	\$600	N/A
Z30L7ENL	24 x 30 x 71.9-72.4	125	278.48	36.25	\$1809	\$1859	\$511	N/A
Z24L7ENL	24 x 24 x 71.9-72.4	100	247.90	29.75	\$1719	\$1760	\$400	N/A
Z36M7ENL	20 x 36 x 71.9-72.4	125	274.99	36.75	\$1835	\$1885	\$600	N/A
Z30M7ENL	20 x 30 x 71.9-72.4	100	247.36	30.50	\$1674	\$1717	\$511	N/A
Z24M7ENL	20 x 24 x 71.9-72.4	100	218.79	25.25	\$1597	\$1633	\$400	N/A

Two file drawers on bottom. Laminate door is standard on wardrobe section. Storage compartment on **left includes two 3-position fixed/height adjustable shelves**. Wardrobe compartment on **right** includes hanging rod and one adjustable shelf above rod. Upper lock secures storage and wardrobe compartments. Lower lock secures all drawers.

Z36L7ENR	24 x 36 x 71.9-72.4	125	309.60	43.25	\$1979	\$2037	\$600	N/A
Z30L7ENR	24 x 30 x 71.9-72.4	125	278.48	36.25	\$1809	\$1859	\$511	N/A
Z24L7ENR	24 x 24 x 71.9-72.4	100	247.90	29.75	\$1719	\$1760	\$400	N/A
Z36M7ENR	20 x 36 x 71.9-72.4	125	274.99	36.75	\$1835	\$1885	\$600	N/A
Z30M7ENR	20 x 30 x 71.9-72.4	100	247.36	30.50	\$1674	\$1717	\$511	N/A
Z24M7ENR	20 x 24 x 71.9-72.4	100	218.79	25.25	\$1597	\$1633	\$400	N/A

Two file drawers on bottom. Laminate door is standard on wardrobe section. Storage compartment on **right includes two 3-position fixed/height adjustable shelves**. Wardrobe compartment on **left** includes hanging rod and one adjustable shelf above rod. Upper lock secures storage and wardrobe compartments. Lower lock secures all drawers.

Z36L7BFL	24 x 36 x 71.9-72.4	125	326.55	43.25	\$2202	\$2259	\$1060	N/A
Z30L7BFL	24 x 30 x 71.9-72.4	100	292.95	36.25	\$2034	\$2084	\$973	N/A
Z24L7BFL	24 x 24 x 71.9-72.4	100	262.10	29.75	\$1913	\$1954	\$861	N/A
Z36M7BFL	20 x 36 x 71.9-72.4	125	291.90	36.75	\$2065	\$2115	\$1060	N/A
Z30M7BFL	20 x 30 x 71.9-72.4	100	262.50	30.50	\$1927	\$1969	\$916	N/A
Z24M7BFL	20 x 24 x 71.9-72.4	100	232.98	25.25	\$1792	\$1826	\$861	N/A

Two box and one file drawer on bottom. Laminate doors are standard. Storage compartment on **left includes two 3-position fixed/height adjustable shelves**. Wardrobe compartment on **right** includes hanging rod and one adjustable shelf above rod. Upper lock secures storage and wardrobe compartments. Lower lock secures all drawers.

Z36L7BFR	24 x 36 x 71.9-72.4	125	326.55	43.25	\$2202	\$2259	\$1060	N/A
Z30L7BFR	24 x 30 x 71.9-72.4	100	292.95	36.25	\$2034	\$2084	\$973	N/A
Z24L7BFR	24 x 24 x 71.9-72.4	100	262.10	29.75	\$1913	\$1954	\$861	N/A
Z36M7BFR	20 x 36 x 71.9-72.4	125	291.90	36.75	\$2065	\$2115	\$1060	N/A
Z30M7BFR	20 x 30 x 71.9-72.4	100	262.50	30.50	\$1927	\$1969	\$916	N/A
Z24M7BFR	20 x 24 x 71.9-72.4	100	232.98	25.25	\$1792	\$1826	\$861	N/A

Two box and one file drawer on bottom. Laminate doors are standard. Storage compartment on **right includes two 3-position fixed/height adjustable shelves**. Wardrobe compartment on **left** includes hanging rod and one adjustable shelf above rod. Upper lock secures storage and wardrobe compartments. Lower lock secures all drawers.

Z36L7BFCL	24 x 36 x 71.9-72.4	125	317.68	43.25	\$2178	\$2212	\$964	N/A
Z30L7BFCL	24 x 30 x 71.9-72.4	125	287	36.25	\$2011	\$2039	\$875	N/A
Z24L7BFCL	24 x 24 x 71.9-72.4	100	258.59	29.75	\$1882	\$1923	\$763	N/A
Z36M7BFCL	20 x 36 x 71.9-72.4	125	288.78	36.75	\$2027	\$2077	\$964	N/A
Z30M7BFCL	20 x 30 x 71.9-72.4	100	259.37	30.50	\$1887	\$1930	\$875	N/A
Z24M7BFCL	20 x 24 x 71.9-72.4	100	229.45	25.25	\$1759	\$1793	\$763	N/A

Two box and one file drawer on bottom. Laminate doors are standard. Storage compartment on **left includes one 3-position fixed/height adjustable shelves**. Wardrobe compartment on **right** includes hanging rod and one adjustable shelf above rod. Upper lock secures storage and wardrobe compartments. Lower lock secures all drawers.

Required Specifications

- Top finish
- Base finish
- Top/Edge Detail
- Handles

Optional Specifications

- Glazing - Doors
- Collator (Open Shelves)
- Box Drawer Option (no upcharge)

PERSONAL TOWERS - 71.5" / 72" HIGH

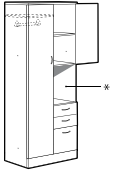

Personal Tower with Doors and Cavity - RIGHT

MODEL#	DIMENSIONS D x W x H	FREIGHT CLASS	WT./LBS.	CUBIC FT.	1" TOP	1.5" TOP	GLAZE ADD	HP ADD
Z36L7BFCR	24 x 36 x 71.9-72.4	125	317.68	43.25	\$2178	\$2212	\$964	N/A
Z30L7BFCR	24 x 30 x 71.9-72.4	125	287	36.25	\$2011	\$2039	\$875	N/A
Z24L7BFCR	24 x 24 x 71.9-72.4	100	258.59	29.75	\$1882	\$1923	\$763	N/A
Z36M7BFCR	20 x 36 x 71.9-72.4	125	288.78	36.75	\$2027	\$2077	\$964	N/A
Z30M7BFCR	20 x 30 x 71.9-72.4	100	259.37	30.50	\$1887	\$1930	\$875	N/A
Z24M7BFCR	20 x 24 x 71.9-72.4	100	229.45	25.25	\$1759	\$1793	\$763	N/A

Two box and one file drawer on bottom. Laminate doors are standard. Storage compartment on **left** includes **one 3-position fixed/height adjustable shelves** Wardrobe compartment on **right** includes hanging rod and one adjustable shelf above rod. Upper lock secures storage and wardrobe compartments. Lower lock secures all drawers.

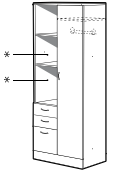

Personal Tower with Open Shelves - LEFT

Z36L7BFNL	24 x 36 x 71.9-72.4	125	309	43.25	\$2077	\$2116	\$600	N/A
Z30L7BFNL	24 x 30 x 71.9-72.4	125	277	36.25	\$1907	\$1936	\$511	N/A
Z24L7BFNL	24 x 24 x 71.9-72.4	100	249.24	29.75	\$1756	\$1797	\$400	N/A
Z36M7BFNL	20 x 36 x 71.9-72.4	125	274	36.75	\$1920	\$1971	\$600	N/A
Z30M7BFNL	20 x 30 x 71.9-72.4	100	246	30.50	\$1780	\$1823	\$511	N/A
Z24M7BFNL	20 x 24 x 71.9-72.4	100	220.12	25.25	\$1635	\$1669	\$400	N/A

Two box and one file drawer on bottom. Laminate doors are standard. Storage compartment on **left** includes **two 3-position fixed/height adjustable shelves**. Wardrobe compartment on **right** includes hanging rod and **one adjustable shelf** above rod. Upper lock secures storage and wardrobe compartments. Lower lock secures all drawers.

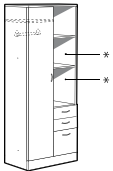

Personal Tower with Open Shelves - RIGHT

Z36L7BFNR	24 x 36 x 71.9-72.4	125	309	43.25	\$2077	\$2116	\$600	N/A
Z30L7BFNR	24 x 30 x 71.9-72.4	125	277	36.25	\$1907	\$1936	\$511	N/A
Z24L7BFNR	24 x 24 x 71.9-72.4	100	249.24	29.75	\$1756	\$1797	\$400	N/A
Z36M7BFNR	20 x 36 x 71.9-72.4	125	274	36.75	\$1920	\$1971	\$600	N/A
Z30M7BFNR	20 x 30 x 71.9-72.4	100	246	30.50	\$1780	\$1823	\$511	N/A
Z24M7BFNR	20 x 24 x 71.9-72.4	100	220.12	25.25	\$1635	\$1669	\$400	N/A

Two box and one file drawer on bottom. Laminate doors are standard. Storage compartment on **right** includes **two 3-position fixed/height adjustable shelves**. Wardrobe compartment on **left** includes hanging rod and **one adjustable shelf** above rod. Upper lock secures storage and wardrobe compartments. Lower lock secures all drawers.

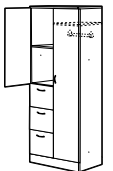

Personal Tower with Doors - LEFT

Z36L73FL	24 x 36 x 71.9-72.4	125	329.70	43.25	\$2207	\$2265	\$964	N/A
Z30L73FL	24 x 30 x 71.9-72.4	100	295.05	36.25	\$2045	\$2095	\$875	N/A
Z24L73FL	24 x 24 x 71.9-72.4	100	264.77	29.75	\$1907	\$1949	\$763	N/A
Z36M73FL	20 x 36 x 71.9-72.4	100	296.10	36.75	\$2091	\$2141	\$964	N/A
Z30M73FL	20 x 30 x 71.9-72.4	100	266.70	30.50	\$1930	\$1972	\$875	N/A
Z24M73FL	20 x 24 x 71.9-72.4	100	237.97	25.25	\$1791	\$1827	\$763	N/A

Three file drawers on bottom. Laminate doors are standard. Storage compartment on **left** includes **one 3-position fixed/height adjustable shelf**. Wardrobe compartment on **right** includes hanging rod and **one adjustable shelf** above rod. Upper lock secures storage and wardrobe compartments. Lower lock secures all drawers.

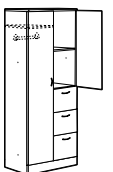

Personal Tower with Doors - RIGHT

Z36L73FR	24 x 36 x 71.9-72.4	125	329.70	43.25	\$2207	\$2265	\$964	N/A
Z30L73FR	24 x 30 x 71.9-72.4	100	295.05	36.25	\$2045	\$2095	\$875	N/A
Z24L73FR	24 x 24 x 71.9-72.4	100	264.77	29.75	\$1907	\$1949	\$763	N/A
Z36M73FR	20 x 36 x 71.9-72.4	100	296.10	36.75	\$2091	\$2141	\$964	N/A
Z30M73FR	20 x 30 x 71.9-72.4	100	266.70	30.50	\$1930	\$1972	\$875	N/A
Z24M73FR	20 x 24 x 71.9-72.4	100	237.97	25.25	\$1791	\$1827	\$763	N/A

Three file drawers on bottom. Laminate doors are standard. Storage compartment on **right** includes **one 3-position fixed/height adjustable shelf**. Wardrobe compartment on **left** includes hanging rod and **one adjustable shelf** above rod. Upper lock secures storage and wardrobe compartments. Lower lock secures all drawers.

Required Specifications

Top finish
Base finish
Top/Edge Detail
Handles

Optional Specifications

Glazing - Doors
Collator (Open Shelves)
Box Drawer Option (no upcharge)

PERSONAL TOWERS - 71.5" / 72" HIGH

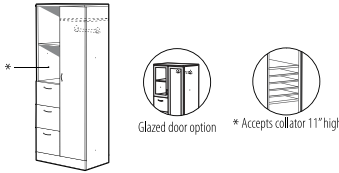

Personal Tower with Open Shelves - LEFT

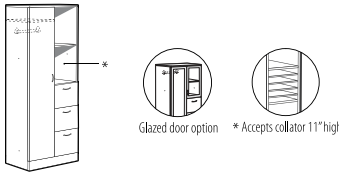

Personal Tower with Open Shelves - RIGHT

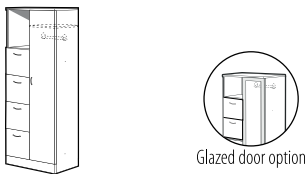

Personal Tower with Open Shelf - LEFT

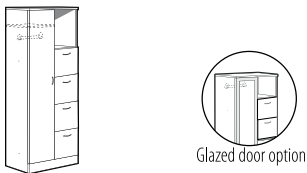

Personal Tower with Open Shelf - RIGHT

MODEL#	DIMENSIONS	FREIGHT CLASS	WT/LBS.	CUBIC FT.	1" TOP	1.5" TOP	GLAZE ADD	HP ADD	
D x W x H									
Z36L73FNL	24 x 36 x 71.9-72.4	125	318.84	43.25	\$2096	\$2154	\$600	N/A	
Z30L73FNL	24 x 30 x 71.9-72.4	125	287.05	36.25	\$1934	\$1984	\$511	N/A	
Z24L73FNL	24 x 24 x 71.9-72.4	100	256.34	29.75	\$1782	\$1823	\$400	N/A	
Z36M73FNL	20 x 36 x 71.9-72.4	125	286.33	36.75	\$1979	\$2029	\$600	N/A	
Z30M73FNL	20 x 30 x 71.9-72.4	100	258.03	30.50	\$1817	\$1860	\$511	N/A	
Z24M73FNL	20 x 24 x 71.9-72.4	100	228.38	25.25	\$1666	\$1702	\$400	N/A	

Three file drawers on bottom. Laminate door is standard on wardrobe section. Storage compartment on **left includes one 3-position fixed/height adjustable shelf**. Wardrobe compartment on **right** includes hanging rod and **one 3-position fixed/height adjustable shelf** above rod. Upper lock secures storage and wardrobe compartments. Lower lock secures all drawers.

Z36L73FNR	24 x 36 x 71.9-72.4	125	318.84	43.25	\$2096	\$2154	\$600	N/A
Z30L73FNR	24 x 30 x 71.9-72.4	125	287.05	36.25	\$1934	\$1984	\$511	N/A
Z24L73FNR	24 x 24 x 71.9-72.4	100	256.34	29.75	\$1782	\$1823	\$400	N/A
Z36M73FNR	20 x 36 x 71.9-72.4	125	286.33	36.75	\$1979	\$2029	\$600	N/A
Z30M73FNR	20 x 30 x 71.9-72.4	100	258.03	30.50	\$1817	\$1860	\$511	N/A
Z24M73FNR	20 x 24 x 71.9-72.4	100	228.38	25.25	\$1666	\$1702	\$400	N/A

Three file drawers on bottom. Laminate door is standard on wardrobe section. Storage compartment on **right includes one 3-position fixed/height adjustable shelf**. Wardrobe compartment on **left** includes hanging rod and **one 3-position fixed/height adjustable shelf** above rod. Upper lock secures storage and wardrobe compartments. Lower lock secures all drawers.

Z36L74FNL	24 x 36 x 71.9-72.4	125	329.70	43.25	\$2160	\$2217	\$600	N/A
Z30L74FNL	24 x 30 x 71.9-72.4	100	290.85	36.25	\$2013	\$2063	\$511	N/A
Z24L74FNL	24 x 24 x 71.9-72.4	100	264.77	29.75	\$1891	\$1932	\$400	N/A
Z36M74FNL	20 x 36 x 71.9-72.4	100	296.10	36.75	\$2073	\$2124	\$600	N/A
Z30M74FNL	20 x 30 x 71.9-72.4	100	266.70	30.50	\$1910	\$1953	\$511	N/A
Z24M74FNL	20 x 24 x 71.9-72.4	100	237.97	25.25	\$1778	\$1812	\$400	N/A

Four file drawers on bottom. Laminate door is standard on wardrobe section. Storage compartment on **left includes one 3-position fixed/height adjustable shelf**. Wardrobe compartment on **right** includes hanging rod and **one 3-position fixed/height adjustable shelf** above rod. Upper lock secures storage and wardrobe compartments. Lower lock secures all drawers.

Z36L74FNR	24 x 36 x 71.9-72.4	125	329.70	43.25	\$2160	\$2217	\$600	N/A
Z30L74FNR	24 x 30 x 71.9-72.4	100	290.85	36.25	\$2013	\$2063	\$511	N/A
Z24L74FNR	24 x 24 x 71.9-72.4	100	264.77	29.75	\$1891	\$1932	\$400	N/A
Z36M74FNR	20 x 36 x 71.9-72.4	100	296.10	36.75	\$2073	\$2124	\$600	N/A
Z30M74FNR	20 x 30 x 71.9-72.4	100	266.70	30.50	\$1910	\$1953	\$511	N/A
Z24M74FNR	20 x 24 x 71.9-72.4	100	237.97	25.25	\$1778	\$1812	\$400	N/A

Four file drawers on bottom. Laminate door is standard on wardrobe section. Storage compartment on **right includes one 3-position fixed/height adjustable shelf**. Wardrobe compartment on **left** includes hanging rod and **one 3-position fixed/height adjustable shelf** above rod. Upper lock secures storage and wardrobe compartments. Lower lock secures all drawers.

STORAGE MODULES - 84" / 84.5" HIGH

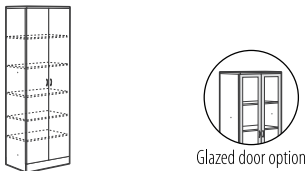

Storage Cabinet with Doors

MODEL#	DIMENSIONS	FREIGHT CLASS	WT/LBS.	CUBIC FT.	1" TOP	1.5" TOP	GLAZE ADD	HP ADD
Z36L8SH	24 x 36 x 84.4-84.9	125	332.85	50	\$2042	\$2100	\$1454	N/A
Z30L8SH	24 x 30 x 84.4-84.9	125	290.85	42	\$1811	\$1861	\$1244	N/A
Z36M8SH	20 x 36 x 84.4-84.9	125	299.25	42.25	\$1883	\$1933	\$1454	N/A
Z30M8SH	20 x 30 x 84.4-84.9	125	259.35	35.50	\$1684	\$1727	\$1244	N/A
Z36S8SH	16 x 36 x 84.4-84.9	125	259.35	34	\$1696	\$1745	\$1454	N/A
Z30S8SH	16 x 30 x 84.4-84.9	125	224.70	29	\$1512	\$1546	\$1244	N/A

Laminate doors are standard. **Includes five 3-position fixed/height adjustable shelves**. Standard with lock.

Required Specifications

Top finish
Base finish
Top/Edge Detail
Handles

Optional Specifications

Glazing - Doors
Collator (Open Shelves)
Box Drawer Option (no upcharge)

STORAGE MODULES - 84" / 84.5" HIGH

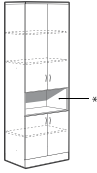

Glazed door option * Accepts collator 11" high

Storage Cabinet with Doors and Cavity

MODEL#	DIMENSIONS D x W x H	FREIGHT CLASS	WT./LBS.	CUBIC FT.	1" TOP	1.5" TOP	GLAZE ADD	HP ADD
Z36L8SHC	24 x 36 x 84.4-84.9	125	326.75	50	\$2082	\$2140	\$1537	N/A
Z30L8SHC	24 x 30 x 84.4-84.9	125	285.07	42	\$1865	\$1915	\$1347	N/A
Z36M8SHC	20 x 36 x 84.4-84.9	125	291.09	42.25	\$1933	\$1984	\$1537	N/A
Z30M8SHC	20 x 30 x 84.4-84.9	125	252.90	35.50	\$1739	\$1782	\$1347	N/A
Z36S8SHC	16 x 36 x 84.4-84.9	125	252.27	34	\$1747	\$1796	\$1537	N/A
Z30S8SHC	16 x 30 x 84.4-84.9	125	218.63	29	\$1568	\$1601	\$1347	N/A

Laminate doors are standard. **Includes three 3-position fixed/height adjustable shelves.** Upper and lower locks secure both compartments.



Glazed door option

Storage Cabinet with Door - LEFT

Z21L8SHL	24 x 21 x 84.4-84.9	125	226.80	30.25	\$1478	\$1519	\$811	N/A
Z18L8SHL	24 x 18 x 84.4-84.9	125	205.80	26.25	\$1390	\$1424	\$724	N/A
Z16L8SHL	24 x 16 x 84.4-84.9	125	186.90	24	\$1304	\$1337	\$719	N/A
Z15L8SHL	24 x 15 x 84.4-84.9	100	181.65	22.50	\$1287	\$1315	\$618	N/A
Z12L8SHL	24 x 12 x 84.4-84.9	100	163.80	18.50	\$1198	\$1221	\$552	N/A
Z21M8SHL	20 x 21 x 84.4-84.9	125	201.60	25.50	\$1334	\$1367	\$811	N/A
Z18M8SHL	20 x 18 x 84.4-84.9	100	180.60	22.25	\$1278	\$1307	\$724	N/A
Z16M8SHL	20 x 16 x 84.4-84.9	100	169.05	20.25	\$1198	\$1227	\$719	N/A
Z15M8SHL	20 x 15 x 84.4-84.9	100	162.75	19	\$1147	\$1170	\$618	N/A
Z12M8SHL	20 x 12 x 84.4-84.9	100	144.90	15.75	\$1063	\$1083	\$552	N/A
Z21S8SHL	16 x 21 x 84.4-84.9	100	172.20	21	\$1219	\$1246	\$811	N/A
Z18S8SHL	16 x 18 x 84.4-84.9	100	154.35	18	\$1141	\$1169	\$724	N/A
Z16S8SHL	16 x 16 x 84.4-84.9	100	142.80	16.50	\$1070	\$1098	\$719	N/A
Z15S8SHL	16 x 15 x 84.4-84.9	100	137.55	15.50	\$1019	\$1041	\$618	N/A
Z12S8SHL	16 x 12 x 84.4-84.9	100	120.75	13	\$941	\$960	\$552	N/A

Laminate doors are standard. **Includes five 3-position fixed/height adjustable shelves.** Standard with lock.



Glazed door option

Storage Cabinet with Door - RIGHT

Z21L8SHR	24 x 21 x 84.4-84.9	125	226.80	30.25	\$1478	\$1519	\$811	N/A
Z18L8SHR	24 x 18 x 84.4-84.9	125	205.80	26.25	\$1390	\$1424	\$724	N/A
Z16L8SHR	24 x 16 x 84.4-84.9	125	186.90	24	\$1304	\$1337	\$719	N/A
Z15L8SHR	24 x 15 x 84.4-84.9	100	181.65	22.50	\$1287	\$1315	\$618	N/A
Z12L8SHR	24 x 12 x 84.4-84.9	100	163.80	18.50	\$1198	\$1221	\$552	N/A
Z21M8SHR	20 x 21 x 84.4-84.9	125	201.60	25.50	\$1334	\$1367	\$811	N/A
Z18M8SHR	20 x 18 x 84.4-84.9	100	180.60	22.25	\$1278	\$1307	\$724	N/A
Z16M8SHR	20 x 16 x 84.4-84.9	100	169.05	20.25	\$1198	\$1227	\$719	N/A
Z15M8SHR	20 x 15 x 84.4-84.9	100	162.75	19	\$1147	\$1170	\$618	N/A
Z12M8SHR	20 x 12 x 84.4-84.9	100	144.90	15.75	\$1063	\$1083	\$552	N/A
Z21S8SHR	16 x 21 x 84.4-84.9	100	172.20	21	\$1219	\$1246	\$811	N/A
Z18S8SHR	16 x 18 x 84.4-84.9	100	154.35	18	\$1141	\$1169	\$724	N/A
Z16S8SHR	16 x 16 x 84.4-84.9	100	142.80	16.50	\$1070	\$1098	\$719	N/A
Z15S8SHR	16 x 15 x 84.4-84.9	100	137.55	15.50	\$1019	\$1041	\$618	N/A
Z12S8SHR	16 x 12 x 84.4-84.9	100	120.75	13	\$941	\$960	\$552	N/A

Laminate doors are standard. **Includes five 3-position fixed/height adjustable shelves.** Standard with lock.

Required Specifications

- Top finish
- Base finish
- Top/Edge Detail
- Handles

Optional Specifications

- Glazing - Doors
- Collator (Open Shelves)

STORAGE MODULES - 84" / 84.5" HIGH

MODEL#	DIMENSIONS	FREIGHT CLASS	WT./LBS.	CUBIC FT.	1" TOP	1.5" TOP	GLAZE ADD	HP ADD	
D x W x H									
Z21L8SHCL	24 x 21 x 84.4-84.9	125	223.07	30.25	\$1506	\$1547	\$842	N/A	
Z18L8SHCL	24 x 18 x 84.4-84.9	125	202.75	26.25	\$1419	\$1453	\$762	N/A	
Z16L8SHCL	24 x 16 x 84.4-84.9	125	185.71	24	\$1330	\$1364	\$751	N/A	
Z15L8SHCL	24 x 15 x 84.4-84.9	125	179.28	22.50	\$1318	\$1346	\$665	N/A	
Z12L8SHCL	24 x 12 x 84.4-84.9	100	162.12	18.50	\$1182	\$1205	\$600	N/A	
Z21M8SHCL	20 x 21 x 84.4-84.9	125	196.66	25.50	\$1357	\$1391	\$842	N/A	
Z18M8SHCL	20 x 18 x 84.4-84.9	125	177.57	22.25	\$1306	\$1335	\$762	N/A	
Z16M8SHCL	20 x 16 x 84.4-84.9	100	165.89	20.25	\$1226	\$1255	\$751	N/A	
Z15M8SHCL	20 x 15 x 84.4-84.9	100	159.52	19	\$1176	\$1201	\$665	N/A	
Z12M8SHCL	20 x 12 x 84.4-84.9	100	141.48	15.75	\$1091	\$1111	\$600	N/A	
Z21S8SHCL	16 x 21 x 84.4-84.9	100	168.16	21	\$1247	\$1275	\$842	N/A	
Z18S8SHCL	16 x 18 x 84.4-84.9	100	150.29	18	\$1170	\$1198	\$762	N/A	
Z16S8SHCL	16 x 16 x 84.4-84.9	100	139.77	16.50	\$1098	\$1126	\$751	N/A	
Z15S8SHCL	16 x 15 x 84.4-84.9	100	134.51	15.50	\$1048	\$1071	\$665	N/A	
Z12S8SHCL	16 x 12 x 84.4-84.9	100	117.69	13	\$969	\$989	\$600	N/A	

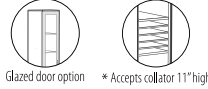
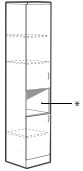

Storage Cabinet with Doors and Cavity - LEFT

Laminate doors are standard. Includes three adjustable shelves. Upper and lower locks secure both compartments

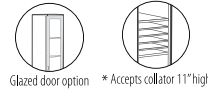
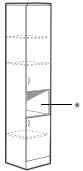

Storage Cabinet with Doors and Cavity - RIGHT

Z21L8SHCR	24 x 21 x 84.4-84.9	125	223.07	30.25	\$1506	\$1547	\$842	N/A
Z18L8SHCR	24 x 18 x 84.4-84.9	125	202.75	26.25	\$1419	\$1453	\$762	N/A
Z16L8SHCR	24 x 16 x 84.4-84.9	125	185.71	24	\$1330	\$1364	\$751	N/A
Z15L8SHCR	24 x 15 x 84.4-84.9	125	179.28	22.50	\$1318	\$1346	\$665	N/A
Z12L8SHCR	24 x 12 x 84.4-84.9	100	162.12	18.50	\$1182	\$1205	\$600	N/A
Z21M8SHCR	20 x 21 x 84.4-84.9	125	196.66	25.50	\$1357	\$1391	\$842	N/A
Z18M8SHCR	20 x 18 x 84.4-84.9	125	177.57	22.25	\$1306	\$1335	\$762	N/A
Z16M8SHCR	20 x 16 x 84.4-84.9	100	165.89	20.25	\$1226	\$1255	\$751	N/A
Z15M8SHCR	20 x 15 x 84.4-84.9	100	159.52	19	\$1176	\$1201	\$665	N/A
Z12M8SHCR	20 x 12 x 84.4-84.9	100	141.48	15.75	\$1091	\$1111	\$600	N/A
Z21S8SHCR	16 x 21 x 84.4-84.9	100	168.16	21	\$1247	\$1275	\$842	N/A
Z18S8SHCR	16 x 18 x 84.4-84.9	100	150.29	18	\$1170	\$1198	\$762	N/A
Z16S8SHCR	16 x 16 x 84.4-84.9	100	139.77	16.50	\$1098	\$1126	\$751	N/A
Z15S8SHCR	16 x 15 x 84.4-84.9	100	134.51	15.50	\$1048	\$1071	\$665	N/A
Z12S8SHCR	16 x 12 x 84.4-84.9	100	117.69	13	\$969	\$989	\$600	N/A

Laminate doors are standard. Includes three adjustable shelves. Upper and lower locks secure both compartments

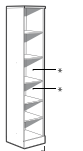
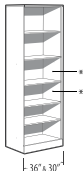

Open Storage Cabinet

Z36L8SHN	24 x 36 x 84.4-84.9	150	281.34	50	\$1587	\$1644	N/A	N/A
Z30L8SHN	24 x 30 x 84.4-84.9	150	247.23	42	\$1413	\$1463	N/A	N/A
Z21L8SHN	24 x 21 x 84.4-84.9	125	227.72	30.25	\$1222	\$1262	N/A	N/A
Z18L8SHN	24 x 18 x 84.4-84.9	125	206.74	26.25	\$1158	\$1192	N/A	N/A
Z16L8SHN	24 x 16 x 84.4-84.9	125	189.25	24	\$1075	\$1109	N/A	N/A
Z15L8SHN	24 x 15 x 84.4-84.9	100	182.61	22.50	\$1057	\$1085	N/A	N/A
Z12L8SHN	24 x 12 x 84.4-84.9	100	164.78	18.50	\$1015	\$1040	N/A	N/A
Z36M8SHN	20 x 36 x 84.4-84.9	150	245.68	42.25	\$1427	\$1477	N/A	N/A
Z30M8SHN	20 x 30 x 84.4-84.9	125	215.06	35.50	\$1287	\$1330	N/A	N/A
Z21M8SHN	20 x 21 x 84.4-84.9	125	170.18	25.50	\$1080	\$1114	N/A	N/A
Z18M8SHN	20 x 18 x 84.4-84.9	125	154.86	22.25	\$1045	\$1075	N/A	N/A
Z16M8SHN	20 x 16 x 84.4-84.9	125	145.71	20.25	\$970	\$999	N/A	N/A
Z15M8SHN	20 x 15 x 84.4-84.9	125	140.60	19	\$945	\$968	N/A	N/A
Z12M8SHN	20 x 12 x 84.4-84.9	100	126.34	15.75	\$880	\$900	N/A	N/A
Z36S8SHN	16 x 36 x 84.4-84.9	125	206.87	34	\$1241	\$1290	N/A	N/A
Z30S8SHN	16 x 30 x 84.4-84.9	125	180.79	29	\$1115	\$1148	N/A	N/A
Z21S8SHN	16 x 21 x 84.4-84.9	125	141.67	21	\$965	\$992	N/A	N/A
Z18S8SHN	16 x 18 x 84.4-84.9	125	127.58	18	\$865	\$893	N/A	N/A
Z16S8SHN	16 x 16 x 84.4-84.9	125	119.59	16.50	\$840	\$868	N/A	N/A
Z15S8SHN	16 x 15 x 84.4-84.9	125	115.59	15.50	\$818	\$840	N/A	N/A
Z12S8SHN	16 x 12 x 84.4-84.9	125	102.56	13	\$757	\$777	N/A	N/A

Five adjustable shelves.

Required Specifications

- Top finish
- Base finish
- Top/Edge Detail
- Handles

Optional Specifications

- Glazing - Doors
- Collator (Open Shelves)

STORAGE MODULES - 84" / 84.5" HIGH

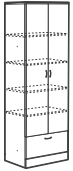

File Module with Doors

MODEL#	DIMENSIONS D x W x H	FREIGHT CLASS	WT/LBS.	CUBIC FT.	1" TOP	1.5" TOP	GLAZE ADD	HP ADD
Z36L8F	24 x 36 x 84.4-84.9	125	350.70	50	\$2346	\$2403	\$1257	N/A
Z30L8F	24 x 30 x 84.4-84.9	125	301.35	42	\$2098	\$2148	\$1066	N/A
Z36M8F	20 x 36 x 84.4-84.9	125	319.20	42.25	\$2196	\$2246	\$1257	N/A
Z30M8F	20 x 30 x 84.4-84.9	125	278.25	35.50	\$1979	\$2022	\$1066	N/A
Z36S8F	16 x 36 x 84.4-84.9	100	273	34	\$1967	\$2016	\$1257	N/A
Z30S8F	16 x 30 x 84.4-84.9	100	237.30	29	\$1766	\$1799	\$1066	N/A

One lateral file drawer. Laminate doors are standard. **Includes four adjustable shelves.** Upper lock secures storage shelves. Lower lock secures one file drawer. Front-to-back and side-to-side letter/legal filing capability. Side-to-side file bars included.

- Lateral file drawer construction is for accommodating hanging files NOT for stacking materials on the drawer bottom.

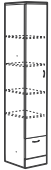

File Module with Door - LEFT

Z16L8FL	24 x 16 x 84.4-84.9	100	200.55	24	\$1436	\$1469	\$620	N/A
Z15L8FL	24 x 15 x 84.4-84.9	100	189	22.50	\$1399	\$1427	\$538	N/A
Z16M8FL	20 x 16 x 84.4-84.9	100	179.55	20.25	\$1330	\$1359	\$620	N/A
Z15M8FL	20 x 15 x 84.4-84.9	100	173.25	19	\$1285	\$1308	\$538	N/A
Z16S8FL	16 x 16 x 84.4-84.9	100	151.20	16.50	\$1198	\$1226	\$620	N/A
Z15S8FL	16 x 15 x 84.4-84.9	100	145.95	15.50	\$1159	\$1182	\$538	N/A

One file drawer. Laminate door is standard. **Includes four adjustable shelves.** Upper lock secures storage compartment. Lower lock secures one file drawer.



File Module with Door - RIGHT

Z16L8FR	24 x 16 x 84.4-84.9	100	200.55	24	\$1436	\$1469	\$620	N/A
Z15L8FR	24 x 15 x 84.4-84.9	100	189	22.50	\$1399	\$1427	\$538	N/A
Z16M8FR	20 x 16 x 84.4-84.9	100	179.55	20.25	\$1330	\$1359	\$620	N/A
Z15M8FR	20 x 15 x 84.4-84.9	100	173.25	19	\$1285	\$1308	\$538	N/A
Z16S8FR	16 x 16 x 84.4-84.9	100	151.20	16.50	\$1198	\$1226	\$620	N/A
Z15S8FR	16 x 15 x 84.4-84.9	100	145.95	15.50	\$1159	\$1182	\$538	N/A

One file drawer. Laminate door is standard. **Includes four adjustable shelves.** Upper lock secures storage compartment. Lower lock secures one file drawer.

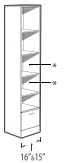
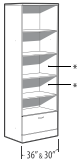

File Module with Open Shelves

Z36L8FN	24 x 36 x 84.4-84.9	125	307.17	50	\$1919	\$1976	N/A	N/A
Z30L8FN	24 x 30 x 84.4-84.9	125	264.38	42	\$1726	\$1776	N/A	N/A
Z16L8FN	24 x 16 x 84.4-84.9	125	182.72	24	\$1229	\$1263	N/A	N/A
Z15L8FN	24 x 15 x 84.4-84.9	125	171.04	22.50	\$1211	\$1239	N/A	N/A
Z36M8FN	20 x 36 x 84.4-84.9	125	273.61	42.25	\$1768	\$1819	N/A	N/A
Z30M8FN	20 x 30 x 84.4-84.9	125	240.61	35.50	\$1607	\$1650	N/A	N/A
Z16M8FN	20 x 16 x 84.4-84.9	125	159.75	20.25	\$1124	\$1153	N/A	N/A
Z15M8FN	20 x 15 x 84.4-84.9	100	154.43	19	\$1094	\$1119	N/A	N/A
Z36S8FN	16 x 36 x 84.4-84.9	125	228.50	34	\$1471	\$1520	N/A	N/A
Z30S8FN	16 x 30 x 84.4-84.9	125	200.04	29	\$1325	\$1358	N/A	N/A
Z16S8FN	16 x 16 x 84.4-84.9	125	131.54	16.50	\$992	\$1020	N/A	N/A
Z15S8FN	16 x 15 x 84.4-84.9	100	127.32	15.50	\$971	\$994	N/A	N/A

Five open shelves and one file drawer on bottom. **Includes four adjustable shelves.** Lock secures file drawer. 36" and 30" wide models have front-to-back and side-to-side letter/legal filing capability. Side-to-side file bars included.

- Lateral file drawer construction is for accommodating hanging files NOT for stacking materials on the drawer bottom.

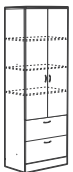

Two File Module with Doors

Z36L8E	24 x 36 x 84.4-84.9	125	365.40	50	\$2534	\$2591	\$1085	N/A
Z30L8E	24 x 30 x 84.4-84.9	125	306.60	42	\$2308	\$2357	\$936	N/A
Z36M8E	20 x 36 x 84.4-84.9	125	323.40	42.25	\$2382	\$2432	\$1085	N/A
Z30M8E	20 x 30 x 84.4-84.9	100	284.55	35.50	\$2194	\$2237	\$936	N/A
Z36S8E	16 x 36 x 84.4-84.9	100	285	34	\$2175	\$2225	\$1085	N/A
Z30S8E	16 x 30 x 84.4-84.9	100	244.65	29	\$1966	\$1999	\$936	N/A

Two lateral file drawers. Laminate doors are standard. **Includes three adjustable shelves.** Upper lock secures storage compartment. Lower lock secures two file drawers. Front-to-back and side-to-side letter/legal filing capability. Side-to-side file bars included.

- Lateral file drawer construction is for accommodating hanging files NOT for stacking materials on the drawer bottom.

Required Specifications

- Top finish
- Base finish
- Top/Edge Detail
- Handles

Optional Specifications

- Glazing - Doors
- Collator (Open Shelves)
- Box Drawer Option (no upcharge)

STORAGE MODULES - 84" / 84.5" HIGH



Glazed door option

Two File Module with Door - LEFT

MODEL#	DIMENSIONS	FREIGHT CLASS	WT/LBS.	CUBIC FT.	1" TOP	1.5" TOP	GLAZE ADD	HP ADD	
D x W x H									
Z16L8EL	24 x 16 x 84.4-84.9	100	205.80	24	\$1508	\$1542	\$534	N/A	
Z15L8EL	24 x 15 x 84.4-84.9	100	192.15	22.50	\$1466	\$1494	\$465	N/A	
Z16M8EL	20 x 16 x 84.4-84.9	100	185.85	20.25	\$1413	\$1442	\$534	N/A	
Z15M8EL	20 x 15 x 84.4-84.9	100	179.55	19	\$1359	\$1384	\$465	N/A	
Z16S8EL	16 x 16 x 84.4-84.9	100	156.45	16.50	\$1284	\$1312	\$534	N/A	
Z15S8EL	16 x 15 x 84.4-84.9	100	149.10	15.50	\$1242	\$1264	\$465	N/A	

Two file drawers on bottom. Laminate door is standard. **Includes three 3-position fixed/height adjustable shelves.** Upper lock secures storage compartment. Lower lock secures two file drawers.



Glazed door option

Two File Module with Door - RIGHT

Z16L8ER	24 x 16 x 84.4-84.9	100	205.80	24	\$1508	\$1542	\$534	N/A
Z15L8ER	24 x 15 x 84.4-84.9	100	192.15	22.50	\$1466	\$1494	\$465	N/A
Z16M8ER	20 x 16 x 84.4-84.9	100	185.85	20.25	\$1413	\$1442	\$534	N/A
Z15M8ER	20 x 15 x 84.4-84.9	100	179.55	19	\$1359	\$1384	\$465	N/A
Z16S8ER	16 x 16 x 84.4-84.9	100	156.45	16.50	\$1284	\$1312	\$534	N/A
Z15S8ER	16 x 15 x 84.4-84.9	100	149.10	15.50	\$1242	\$1264	\$465	N/A

Two file drawers on bottom. Laminate door is standard. **Includes three 3-position fixed/height adjustable shelves.** Upper lock secures storage compartment. Lower lock secures two file drawers.

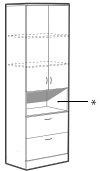

Glazed door option



* Accepts collator 11" high

Two File Module with Doors and Cavity

Z36L8EC	24 x 36 x 84.4-84.9	125	359.30	50	\$2468	\$2526	\$945	N/A
Z30L8EC	24 x 30 x 84.4-84.9	125	300.82	42	\$2253	\$2303	\$822	N/A
Z36M8EC	20 x 36 x 84.4-84.9	125	315.24	42.25	\$2316	\$2366	\$945	N/A
Z30M8EC	20 x 30 x 84.4-84.9	125	278.10	35.50	\$2140	\$2183	\$822	N/A
Z36S8EC	16 x 36 x 84.4-84.9	100	276	34	\$1976	\$2025	\$945	N/A
Z30S8EC	16 x 30 x 84.4-84.9	100	236.48	29	\$1778	\$1811	\$822	N/A

Two lateral file drawers on bottom. Laminate doors are standard. **Includes two 3-position fixed/height adjustable shelves.** Upper lock secures storage compartment. Lower lock secures all drawers. Front-to-back and side-to-side letter/legal filing capability. Side-to-side file bars included.

- Lateral file drawer construction is for accommodating hanging files NOT for stacking materials on the drawer bottom.

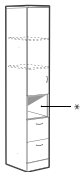

Glazed door option



* Accepts collator 11" high

Two File Module with Doors and Cavity - LEFT

Z16L8ECL	24 x 16 x 84.4-84.9	100	204.61	24	\$1422	\$1456	\$464	N/A
Z15L8ECL	24 x 15 x 84.4-84.9	100	189.78	22.50	\$1438	\$1466	\$408	N/A
Z16M8ECL	20 x 16 x 84.4-84.9	100	182.69	20.25	\$1369	\$1398	\$464	N/A
Z15M8ECL	20 x 15 x 84.4-84.9	100	176.32	19	\$1322	\$1345	\$408	N/A
Z16S8ECL	16 x 16 x 84.4-84.9	100	152.37	16.50	\$1251	\$1279	\$464	N/A
Z15S8ECL	16 x 15 x 84.4-84.9	100	146.06	15.50	\$1213	\$1236	\$408	N/A

Two lateral file drawers on bottom. Laminate doors are standard. **Includes two 3-position fixed/height adjustable shelves.** Upper lock secures storage compartment. Lower lock secures all drawers.

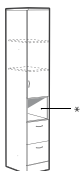

Glazed door option



* Accepts collator 11" high

Two File Module with Doors and Cavity - LEFT

Z16L8ECR	24 x 16 x 84.4-84.9	100	204.61	24	\$1422	\$1456	\$464	N/A
Z15L8ECR	24 x 15 x 84.4-84.9	100	189.78	22.50	\$1438	\$1466	\$408	N/A
Z16M8ECR	20 x 16 x 84.4-84.9	100	182.69	20.25	\$1369	\$1398	\$464	N/A
Z15M8ECR	20 x 15 x 84.4-84.9	100	176.32	19	\$1322	\$1345	\$408	N/A
Z16S8ECR	16 x 16 x 84.4-84.9	100	152.37	16.50	\$1251	\$1279	\$464	N/A
Z15S8ECR	16 x 15 x 84.4-84.9	100	146.06	15.50	\$1213	\$1236	\$408	N/A

Two lateral file drawers on bottom. Laminate doors are standard. **Includes two 3-position fixed/height adjustable shelves.** Upper lock secures storage compartment. Lower lock secures all drawers.

Required Specifications

- Top finish
- Base finish
- Top/Edge Detail
- Handles

Optional Specifications

- Glazing - Doors
- Collator (Open Shelves)
- Box Drawer Option (no upcharge)

STORAGE MODULES - 84" / 84.5" HIGH

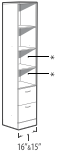
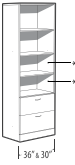

* Accepts collator 11" high

Two File Module with Open Shelves

MODEL#	DIMENSIONS D x W x H	FREIGHT CLASS	WT./LBS.	CUBIC FT.	1" TOP	1.5" TOP	GLAZE ADD	HP ADD
Z36L8EN	24 x 36 x 84.4-84.9	125	329.85	50	\$2172	\$2229	N/A	N/A
Z30L8EN	24 x 30 x 84.4-84.9	125	276.28	42	\$1989	\$2039	N/A	N/A
Z16L8EN	24 x 16 x 84.4-84.9	125	191.52	24	\$1325	\$1359	N/A	N/A
Z15L8EN	24 x 15 x 84.4-84.9	125	177.51	22.50	\$1306	\$1334	N/A	N/A
Z36M8EN	20 x 36 x 84.4-84.9	125	285.79	42.25	\$2019	\$2069	N/A	N/A
Z30M8EN	20 x 30 x 84.4-84.9	125	253.56	35.50	\$1878	\$1921	N/A	N/A
Z16M8EN	20 x 16 x 84.4-84.9	100	169.60	20.25	\$1230	\$1259	N/A	N/A
Z15M8EN	20 x 15 x 84.4-84.9	100	164.05	19	\$1197	\$1222	N/A	N/A
Z36S8EN	16 x 36 x 84.4-84.9	125	247	34	\$1678	\$1727	N/A	N/A
Z30S8EN	16 x 30 x 84.4-84.9	125	213	29	\$1514	\$1547	N/A	N/A
Z16S8EN	16 x 16 x 84.4-84.9	100	139.28	16.50	\$1101	\$1129	N/A	N/A
Z15S8EN	16 x 15 x 84.4-84.9	100	133.79	15.50	\$1080	\$1102	N/A	N/A

Four open shelves and two file drawers on bottom. **Includes two 3-position fixed/height adjustable shelves.** Lock secures all drawers. 36" and 30" wide models have front-to-back and side-to-side letter/legal filing capability. Side-to-side file bars included.

- Lateral file drawer construction is for accommodating hanging files NOT for stacking materials on the drawer bottom.

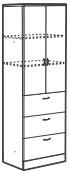

Glazed door option

Three File Module with Doors

Z36L83F	24 x 36 x 84.4-84.9	125	357	50	\$2733	\$2790	\$945	N/A
Z30L83F	24 x 30 x 84.4-84.9	125	319.20	42	\$2502	\$2552	\$822	N/A
Z36M83F	20 x 36 x 84.4-84.9	125	328.65	42.25	\$2595	\$2645	\$945	N/A
Z30M83F	20 x 30 x 84.4-84.9	100	291.90	35.50	\$2399	\$2442	\$822	N/A
Z36S83F	16 x 36 x 84.4-84.9	100	289	34	\$2362	\$2411	\$945	N/A
Z30S83F	16 x 30 x 84.4-84.9	100	246.75	29	\$2146	\$2179	\$822	N/A

Three lateral file drawers on bottom. Laminate doors are standard. **Includes two 3-position fixed/height adjustable shelves.** Upper lock secures storage compartment. Lower lock secures three file drawers. Front-to-back and side-to-side letter/legal filing capability. Side-to-side file bars included.

- Lateral file drawer construction is for accommodating hanging files NOT for stacking materials on the drawer bottom.



Glazed door option

Three File Module with Door - LEFT

Z16L83FL	24 x 16 x 84.4-84.9	100	215.25	24	\$1615	\$1649	\$464	N/A
Z15L83FL	24 x 15 x 84.4-84.9	100	206.85	22.50	\$1559	\$1587	\$408	N/A
Z16M83FL	20 x 16 x 84.4-84.9	100	192.15	20.25	\$1520	\$1549	\$464	N/A
Z15M83FL	20 x 15 x 84.4-84.9	100	184.80	19	\$1471	\$1494	\$408	N/A
Z16S83FL	16 x 16 x 84.4-84.9	100	161.70	16.50	\$1386	\$1414	\$464	N/A
Z15S83FL	16 x 15 x 84.4-84.9	92.5	155.40	15.50	\$1350	\$1372	\$408	N/A

Three file drawers on bottom. Laminate door is standard. **Includes two 3-position fixed/height adjustable shelves.** Upper lock secures storage compartment. Lower lock secures three file drawers.

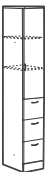

Glazed door option

Three File Module with Door - RIGHT

Z16L83FR	24 x 16 x 84.4-84.9	100	215.25	24	\$1615	\$1649	\$464	N/A
Z15L83FR	24 x 15 x 84.4-84.9	100	206.85	22.50	\$1559	\$1587	\$408	N/A
Z16M83FR	20 x 16 x 84.4-84.9	100	192.15	20.25	\$1520	\$1549	\$464	N/A
Z15M83FR	20 x 15 x 84.4-84.9	100	184.80	19	\$1471	\$1494	\$408	N/A
Z16S83FR	16 x 16 x 84.4-84.9	100	161.70	16.50	\$1386	\$1414	\$464	N/A
Z15S83FR	16 x 15 x 84.4-84.9	92.5	155.40	15.50	\$1350	\$1372	\$408	N/A

Three file drawers on bottom. Laminate door is standard. **Includes two 3-position fixed/height adjustable shelves.** Upper lock secures storage compartment. Lower lock secures three file drawers.

Required Specifications

- Top finish
- Base finish
- Top/Edge Detail
- Handles

Optional Specifications

- Glazing - Doors
- Collator (Open Shelves)
- Box Drawer Option (no upcharge)

STORAGE MODULES - 84" / 84.5" HIGH

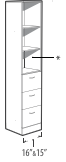
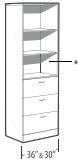

* Accepts collator 11" high

Three File Module with Open Shelves

MODEL#	DIMENSIONS D x W x H	FREIGHT CLASS	WT/LBS.	CUBIC FT.	1" TOP	1.5" TOP	GLAZE ADD	HP ADD
Z36L83FN	24 x 36 x 84.4-84.9	125	329.44	50	\$2434	\$2492	N/A	N/A
Z30L83FN	24 x 30 x 84.4-84.9	125	295.53	42	\$2239	\$2289	N/A	N/A
Z16L83FN	24 x 16 x 84.4-84.9	100	204.52	24	\$1464	\$1497	N/A	N/A
Z15L83FN	24 x 15 x 84.4-84.9	100	195.54	22.50	\$1425	\$1453	N/A	N/A
Z36M83FN	20 x 36 x 84.4-84.9	125	299.02	42.25	\$2295	\$2345	N/A	N/A
Z30M83FN	20 x 30 x 84.4-84.9	125	267.56	35.50	\$2136	\$2179	N/A	N/A
Z16M83FN	20 x 16 x 84.4-84.9	100	179.45	20.25	\$1368	\$1398	N/A	N/A
Z15M83FN	20 x 15 x 84.4-84.9	100	172.63	19	\$1336	\$1361	N/A	N/A
Z36S83FN	16 x 36 x 84.4-84.9	125	260	34	\$1863	\$1912	N/A	N/A
Z30S83FN	16 x 30 x 84.4-84.9	125	222.79	29	\$1679	\$1713	N/A	N/A
Z16S83FN	16 x 16 x 84.4-84.9	100	149.13	16.50	\$1233	\$1261	N/A	N/A
Z15S83FN	16 x 15 x 84.4-84.9	100	143.42	15.50	\$1216	\$1238	N/A	N/A

Three open shelves and three file drawers on bottom. **Includes two 3-position fixed/height adjustable shelves.** Lock secures all drawers. 36" and 30" wide models have front-to-back and side-to-side letter/legal filing capability. Side-to-side file bars included.

- Lateral file drawer construction is for accommodating hanging files NOT for stacking materials on the drawer bottom.

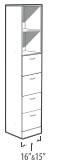
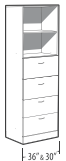

Four File Module with Open Shelf

Z36L84FN	24 x 36 x 84.4-84.9	125	340.57	50	\$2673	\$2731	N/A	N/A
Z30L84FN	24 x 30 x 84.4-84.9	125	308.48	42	\$2480	\$2530	N/A	N/A
Z16L84FN	24 x 16 x 84.4-84.9	100	208.06	24	\$1547	\$1580	N/A	N/A
Z15L84FN	24 x 15 x 84.4-84.9	100	200.97	22.50	\$1518	\$1546	N/A	N/A
Z36M84FN	20 x 36 x 84.4-84.9	125	313.30	42.25	\$2549	\$2599	N/A	N/A
Z30M84FN	20 x 30 x 84.4-84.9	125	282.61	35.50	\$2383	\$2425	N/A	N/A
Z16M84FN	20 x 16 x 84.4-84.9	100	187.20	20.25	\$1439	\$1468	N/A	N/A
Z15M84FN	20 x 15 x 84.4-84.9	100	181.21	19	\$1434	\$1459	N/A	N/A
Z36S84FN	16 x 36 x 84.4-84.9	125	265.04	34	\$2011	\$2060	N/A	N/A
Z30S84FN	16 x 30 x 84.4-84.9	100	233.64	29	\$1812	\$1845	N/A	N/A
Z16S84FN	16 x 16 x 84.4-84.9	100	156.88	16.50	\$1336	\$1364	N/A	N/A
Z15S84FN	16 x 15 x 84.4-84.9	100	152	15.50	\$1321	\$1344	N/A	N/A

Two open shelves and four file drawers. **Includes one 3-position fixed/height adjustable shelf.** Lock secures all drawers. 36" and 30" wide models have front-to-back and side-to-side letter/legal filing capability. Side-to-side file bars included.

- Lateral file drawer construction is for accommodating hanging files NOT for stacking materials on the drawer bottom.

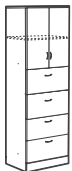

Glazed door option

Four File Module with Doors

Z36L84F	24 x 36 x 84.4-84.9	125	360.15	50	\$2927	\$2984	\$743	N/A
Z30L84F	24 x 30 x 84.4-84.9	125	325.50	42	\$2705	\$2755	\$647	N/A
Z36M84F	20 x 36 x 84.4-84.9	125	334.95	42.25	\$2800	\$2851	\$743	N/A
Z30M84F	20 x 30 x 84.4-84.9	100	300.30	35.50	\$2609	\$2652	\$647	N/A
Z36S84F	16 x 36 x 84.4-84.9	100	285.60	34	\$2532	\$2581	\$743	N/A
Z30S84F	16 x 30 x 84.4-84.9	100	250.95	29	\$2308	\$2341	\$647	N/A

Four lateral file drawers on bottom. Laminate doors are standard. **Includes one 3-position fixed/height adjustable shelf.** Upper lock secures storage compartment. Lower lock secures four file drawers. Front-to-back and side-to-side letter/legal filing capability. Side-to-side file bars included.

- Lateral file drawer construction is for accommodating hanging files NOT for stacking materials on the drawer bottom.

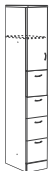

Glazed door option

Four File Module with Door - LEFT

Z16L84FL	24 x 16 x 84.4-84.9	100	217.35	24	\$1674	\$1708	\$364	N/A
Z15L84FL	24 x 15 x 84.4-84.9	100	208.95	22.50	\$1633	\$1661	\$366	N/A
Z16M84FL	20 x 16 x 84.4-84.9	100	196.35	20.25	\$1568	\$1597	\$364	N/A
Z15M84FL	20 x 15 x 84.4-84.9	92.5	190.05	19	\$1549	\$1574	\$321	N/A
Z16S84FL	16 x 16 x 84.4-84.9	92.5	166.95	16.50	\$1465	\$1493	\$364	N/A
Z15S84FL	16 x 15 x 84.4-84.9	92.5	160.65	15.50	\$1435	\$1458	\$321	N/A

Four file drawers on bottom. Laminate door is standard. **Includes one 3-position fixed/height adjustable shelf.** Upper lock secures storage compartment. Lower lock secures four file drawers.

Required Specifications

- Top finish
- Base finish
- Top/Edge Detail
- Handles

Optional Specifications

- Glazing - Doors
- Collator (Open Shelves)
- Box Drawer Option (no upcharge)

STORAGE MODULES - 84" / 84.5" HIGH

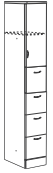

Glazed door option

Four File Module with Door - RIGHT

MODEL#	DIMENSIONS D x W x H	FREIGHT CLASS	WT./LBS.	CUBIC FT.	1" TOP	1.5" TOP	GLAZE ADD	HP ADD
Z16L84FR	24 x 16 x 84.4-84.9	100	217.35	24	\$1674	\$1708	\$364	N/A
Z15L84FR	24 x 15 x 84.4-84.9	100	208.95	22.50	\$1633	\$1661	\$366	N/A
Z16M84FR	20 x 16 x 84.4-84.9	100	196.35	20.25	\$1568	\$1597	\$364	N/A
Z15M84FR	20 x 15 x 84.4-84.9	92.5	190.05	19	\$1549	\$1574	\$321	N/A
Z16S84FR	16 x 16 x 84.4-84.9	92.5	166.95	16.50	\$1465	\$1493	\$364	N/A
Z15S84FR	16 x 15 x 84.4-84.9	92.5	160.65	15.50	\$1435	\$1458	\$321	N/A

Four file drawers on bottom. Laminate door is standard. **Includes one 3-position fixed/height adjustable shelf.** Upper lock secures storage compartment. Lower lock secures four file drawers.



Intended for working while standing

Media Center - LEFT

Z36L8MCL	24 x 36 x 84.4-84.9	125	324.45	50	\$2210	\$2268	N/A	N/A
Z30L8MCL	24 x 30 x 84.4-84.9	125	290.85	42	\$2053	\$2103	N/A	N/A
Z36M8MCL	20 x 36 x 84.4-84.9	125	276.15	42.25	\$2047	\$2097	N/A	N/A
Z30M8MCL	20 x 30 x 84.4-84.9	125	257.25	35.50	\$1881	\$1924	N/A	N/A
Z36S8MCL	16 x 36 x 84.4-84.9	125	246.75	34	\$1816	\$1865	N/A	N/A
Z30S8MCL	16 x 30 x 84.4-84.9	125	212.10	29	\$1654	\$1687	N/A	N/A

Unit, accommodates pc, keyboard, monitor, hanging folders and accessories and/or printer. One vertical drawer on the **left**. Pull out keyboard shelf. Adjustable pull out bottom shelf accommodates pc and/or printer. **Includes two 3-position fixed/height adjustable shelves.** Grommet in worksurface and back panel. Lock secures vertical drawer.



Intended for working while standing

Media Center - RIGHT

Z36L8MCR	24 x 36 x 84.4-84.9	125	324.45	50	\$2210	\$2268	N/A	N/A
Z30L8MCR	24 x 30 x 84.4-84.9	125	290.85	42	\$2053	\$2103	N/A	N/A
Z36M8MCR	20 x 36 x 84.4-84.9	125	276.15	42.25	\$2047	\$2097	N/A	N/A
Z30M8MCR	20 x 30 x 84.4-84.9	125	257.25	35.50	\$1881	\$1924	N/A	N/A
Z36S8MCR	16 x 36 x 84.4-84.9	125	246.75	34	\$1816	\$1865	N/A	N/A
Z30S8MCR	16 x 30 x 84.4-84.9	125	212.10	29	\$1654	\$1687	N/A	N/A

Unit, accommodates pc, keyboard, monitor, hanging folders and accessories and/or printer. One vertical drawer on the **right**. Pull out keyboard shelf. Adjustable pull out bottom shelf accommodates pc and/or printer. **Includes two 3-position fixed/height adjustable shelves.** Grommet in worksurface and back panel. Lock secures vertical drawer.

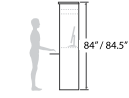

Intended for working while standing

PC Center

Z36L8PC	24 x 36 x 84.4-84.9	150	285.60	50	\$1703	\$1761	N/A	N/A
Z30L8PC	24 x 30 x 84.4-84.9	125	252	42	\$1512	\$1562	N/A	N/A
Z36M8PC	20 x 36 x 84.4-84.9	150	250.95	42.25	\$1566	\$1617	N/A	N/A
Z30M8PC	20 x 30 x 84.4-84.9	125	219.45	35.50	\$1406	\$1449	N/A	N/A
Z36S8PC	16 x 36 x 84.4-84.9	125	218.40	34	\$1356	\$1405	N/A	N/A
Z30S8PC	16 x 30 x 84.4-84.9	125	183.75	29	\$1199	\$1232	N/A	N/A

Standing height unit, accommodates pc, keyboard, monitor and/or printer. Pull out keyboard shelf. Adjustable pull out bottom shelf accommodates pc and/or printer. **Includes two 3-position fixed/height adjustable shelves.** Grommet in worksurface and back panel.

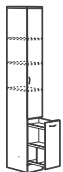
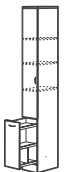

Glazed door option

LEFT RIGHT

Vertical Utility Drawer with Door

Z12L8VDL	24 x 12 x 84.4-84.9	100	184.80	18.50	\$1492	\$1515	\$416	N/A
Z12M8VDL	20 x 12 x 84.4-84.9	92.5	166.95	15.75	\$1216	\$1237	\$416	N/A
Z12S8VDL	16 x 12 x 84.4-84.9	92.5	139.65	13	\$1118	\$1138	\$416	N/A
Z12L8VDR	24 x 12 x 84.4-84.9	100	184.80	18.50	\$1492	\$1515	\$416	N/A
Z12M8VDR	20 x 12 x 84.4-84.9	92.5	166.95	15.75	\$1216	\$1237	\$416	N/A
Z12S8VDR	16 x 12 x 84.4-84.9	92.5	139.65	13	\$1118	\$1138	\$416	N/A

Specify **VDL** models for **LEFT** or **VDR** models for **RIGHT**

Laminate doors are standard. **Includes three 3-position fixed/height adjustable shelves** and one vertical drawer. Upper lock secures storage compartment. Lower lock secures vertical drawer.

Required Specifications

- Top finish
- Base finish
- Top/Edge Detail
- Handles

Optional Specifications

- Glazing - Doors
- Collator (Open Shelves)
- Box Drawer Option (no upcharge - Four File Module)

WARDROBE CABINETS - 84" / 84.5" HIGH

MODEL#	DIMENSIONS	FREIGHT CLASS	WT/LBS.	CUBIC FT.	1" TOP	1.5" TOP	GLAZE ADD	HP ADD
--------	------------	---------------	---------	-----------	--------	----------	-----------	--------



Wardrobe Cabinet

	D x W x H							
Z36L8WA	24 x 36 x 84.4-84.9	150	290.85	50	\$1895	\$1952	N/A	N/A
Z30L8WA	24 x 30 x 84.4-84.9	125	256.20	42	\$1701	\$1751	N/A	N/A
Z36M8WA	20 x 36 x 84.4-84.9	125	264.60	42.25	\$1770	\$1820	N/A	N/A
Z30M8WA	20 x 30 x 84.4-84.9	125	231	35.50	\$1600	\$1643	N/A	N/A

Laminate doors are standard. Full length hanging rod included. **One adjustable shelf** above hanging rod. Standard with lock.



Wardrobe Cabinet - LEFT

Z24L8WAL	24 x 24 x 84.4-84.9	125	220.50	34.25	\$1420	\$1461	N/A	N/A
Z21L8WAL	24 x 21 x 84.4-84.9	125	192.15	30.25	\$1367	\$1407	N/A	N/A
Z18L8WAL	24 x 18 x 84.4-84.9	125	184.80	26.25	\$1274	\$1308	N/A	N/A
Z16L8WAL	24 x 16 x 84.4-84.9	125	172.20	24	\$1216	\$1249	N/A	N/A
Z15L8WAL	24 x 15 x 84.4-84.9	125	161.70	22.50	\$1181	\$1209	N/A	N/A
Z12L8WAL	24 x 12 x 84.4-84.9	100	150.15	18.50	\$1086	\$1111	N/A	N/A
Z24M8WAL	20 x 24 x 84.4-84.9	125	197.40	28.50	\$1322	\$1356	N/A	N/A
Z21M8WAL	20 x 21 x 84.4-84.9	125	182.70	25.50	\$1273	\$1307	N/A	N/A
Z18M8WAL	20 x 18 x 84.4-84.9	125	164.85	22.25	\$1180	\$1209	N/A	N/A
Z16M8WAL	20 x 16 x 84.4-84.9	125	154.35	20.25	\$1125	\$1154	N/A	N/A
Z15M8WAL	20 x 15 x 84.4-84.9	125	149.10	19	\$1079	\$1104	N/A	N/A
Z12M8WAL	20 x 12 x 84.4-84.9	100	133.35	15.75	\$1007	\$1027	N/A	N/A

Laminate doors are standard. Full length hanging rod included. **One adjustable shelf** above hanging rod. Standard with lock.



Wardrobe Cabinet - RIGHT

Z24L8WAR	24 x 24 x 84.4-84.9	125	220.50	34.25	\$1420	\$1461	N/A	N/A
Z21L8WAR	24 x 21 x 84.4-84.9	125	192.15	30.25	\$1367	\$1407	N/A	N/A
Z18L8WAR	24 x 18 x 84.4-84.9	125	184.80	26.25	\$1274	\$1308	N/A	N/A
Z16L8WAR	24 x 16 x 84.4-84.9	125	172.20	24	\$1216	\$1249	N/A	N/A
Z15L8WAR	24 x 15 x 84.4-84.9	125	161.70	22.50	\$1181	\$1209	N/A	N/A
Z12L8WAR	24 x 12 x 84.4-84.9	100	150.15	18.50	\$1086	\$1111	N/A	N/A
Z24M8WAR	20 x 24 x 84.4-84.9	125	197.40	28.50	\$1322	\$1356	N/A	N/A
Z21M8WAR	20 x 21 x 84.4-84.9	125	182.70	25.50	\$1273	\$1307	N/A	N/A
Z18M8WAR	20 x 18 x 84.4-84.9	125	164.85	22.25	\$1180	\$1209	N/A	N/A
Z16M8WAR	20 x 16 x 84.4-84.9	125	154.35	20.25	\$1125	\$1154	N/A	N/A
Z15M8WAR	20 x 15 x 84.4-84.9	125	149.10	19	\$1079	\$1104	N/A	N/A
Z12M8WAR	20 x 12 x 84.4-84.9	100	133.35	15.75	\$1007	\$1027	N/A	N/A

Laminate doors are standard. Full length hanging rod included. **One adjustable shelf** above hanging rod. Standard with lock.



Wardrobe Cabinet/Shelving Combo with Doors - LEFT



Glazed door option

Z36L8DIL	24 x 36 x 84.4-84.9	125	339	50	\$2191	\$2248	\$1454	N/A
Z30L8DIL	24 x 30 x 84.4-84.9	125	301	42	\$1924	\$1974	\$1244	N/A
Z24L8DIL	24 x 24 x 84.4-84.9	125	269	34.25	\$1739	\$1780	\$1141	N/A
Z21L8DIL	24 x 21 x 84.4-84.9	100	252	30.25	\$1684	\$1707	\$1131	N/A
Z36M8DIL	20 x 36 x 84.4-84.9	125	306	42.25	\$2062	\$2112	\$1454	N/A
Z30M8DIL	20 x 30 x 84.4-84.9	125	266	35.50	\$1818	\$1861	\$1244	N/A
Z24M8DIL	20 x 24 x 84.4-84.9	100	233	28.50	\$1639	\$1675	\$1141	N/A
Z21M8DIL	20 x 21 x 84.4-84.9	100	215	25.50	\$1558	\$1600	\$1131	N/A

Laminate doors are standard. Storage compartment on **left includes five adjustable shelves**. Wardrobe compartment on **right** includes hanging rod and **one adjustable shelf** above rod. Both doors lock to secure items.



Wardrobe Cabinet/Shelving Combo with Doors - RIGHT



Glazed door option

Z36L8DIR	24 x 36 x 84.4-84.9	125	339	50	\$2191	\$2248	\$1454	N/A
Z30L8DIR	24 x 30 x 84.4-84.9	125	301	42	\$1924	\$1974	\$1244	N/A
Z24L8DIR	24 x 24 x 84.4-84.9	125	269	34.25	\$1739	\$1780	\$1141	N/A
Z21L8DIR	24 x 21 x 84.4-84.9	100	252	30.25	\$1684	\$1707	\$1131	N/A
Z36M8DIR	20 x 36 x 84.4-84.9	125	306	42.25	\$2062	\$2112	\$1454	N/A
Z30M8DIR	20 x 30 x 84.4-84.9	125	266	35.50	\$1818	\$1861	\$1244	N/A
Z24M8DIR	20 x 24 x 84.4-84.9	100	233	28.50	\$1639	\$1675	\$1141	N/A
Z21M8DIR	20 x 21 x 84.4-84.9	100	215	25.50	\$1558	\$1600	\$1131	N/A

Laminate doors are standard. Storage compartment on **right includes five adjustable shelves**. Wardrobe compartment on **left** includes hanging rod and **one adjustable shelf** above rod. Both doors lock to secure items.

Required Specifications

- Top finish
- Base finish
- Top/Edge Detail
- Handles

Optional Specifications

- Glazing - Doors (Combo Units)

WARDROBE CABINETS - 84" / 84.5" HIGH

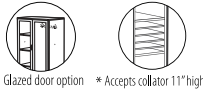
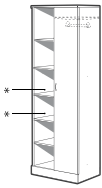

Wardrobe Cabinet/Open Shelving Combo - LEFT

MODEL#	DIMENSIONS D x W x H	FREIGHT CLASS	WT/LBS.	CUBIC FT.	1" TOP	1.5" TOP	GLAZE ADD	HP ADD
Z36L8DINL	24 x 36 x 84.4-84.9	125	312	50	\$1962	\$2019	\$724	N/A
Z30L8DINL	24 x 30 x 84.4-84.9	125	278	42	\$1722	\$1772	\$618	N/A
Z24L8DINL	24 x 24 x 84.4-84.9	125	245	34.25	\$1575	\$1616	\$552	N/A
Z21L8DINL	24 x 21 x 84.4-84.9	125	236	30.25	\$1535	\$1553	\$548	N/A
Z36M8DINL	20 x 36 x 84.4-84.9	125	275	42.25	\$1832	\$1882	\$724	N/A
Z30M8DINL	20 x 30 x 84.4-84.9	125	243	35.50	\$1619	\$1662	\$618	N/A
Z24M8DINL	20 x 24 x 84.4-84.9	125	215	28.50	\$1475	\$1509	\$552	N/A
Z21M8DINL	20 x 21 x 84.4-84.9	125	199	25.50	\$1410	\$1444	\$548	N/A

Laminate door is standard on wardrobe section. Storage compartment on **left includes five adjustable shelves**. Wardrobe compartment on **right** includes hanging rod and **one adjustable shelf** above rod. Single lock secures storage and wardrobe compartments.

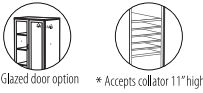
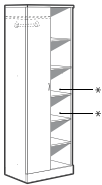

Wardrobe Cabinet/Open Shelving Combo - RIGHT

Z36L8DINR	24 x 36 x 84.4-84.9	125	312	50	\$1962	\$2019	\$724	N/A
Z30L8DINR	24 x 30 x 84.4-84.9	125	278	42	\$1722	\$1772	\$618	N/A
Z24L8DINR	24 x 24 x 84.4-84.9	125	245	34.25	\$1575	\$1616	\$552	N/A
Z21L8DINR	24 x 21 x 84.4-84.9	125	236	30.25	\$1535	\$1553	\$548	N/A
Z36M8DINR	20 x 36 x 84.4-84.9	125	275	42.25	\$1832	\$1882	\$724	N/A
Z30M8DINR	20 x 30 x 84.4-84.9	125	243	35.50	\$1619	\$1662	\$618	N/A
Z24M8DINR	20 x 24 x 84.4-84.9	125	215	28.50	\$1475	\$1509	\$552	N/A
Z21M8DINR	20 x 21 x 84.4-84.9	125	199	25.50	\$1410	\$1444	\$548	N/A

Laminate door is standard on wardrobe section. Storage compartment on **right includes five adjustable shelves**. Wardrobe compartment on **left** includes hanging rod and **one adjustable shelf** above rod. Single lock secures storage and wardrobe compartments.

PERSONAL TOWERS - 84" / 84.5" HIGH

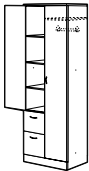

Personal Tower with Doors - LEFT

MODEL#	DIMENSIONS	FREIGHT CLASS	WT/LBS.	CUBIC FT.	1" TOP	1.5" TOP	GLAZE ADD	HP ADD
Z36L8EL	24 x 36 x 84.4-84.9	125	368.55	50	\$2341	\$2399	\$1260	N/A
Z30L8EL	24 x 30 x 84.4-84.9	125	334.95	42	\$2137	\$2187	\$1149	N/A
Z24L8EL	24 x 24 x 84.4-84.9	100	299.24	34.25	\$2066	\$2108	\$992	N/A
Z36M8EL	20 x 36 x 84.4-84.9	125	332.85	42.25	\$2212	\$2262	\$1260	N/A
Z30M8EL	20 x 30 x 84.4-84.9	100	298.20	35.50	\$2039	\$2082	\$1149	N/A
Z24M8EL	20 x 24 x 84.4-84.9	100	266	29	\$1945	\$1979	\$992	N/A

Two file drawers on bottom. Laminate doors are standard. Storage compartment on **left includes three adjustable shelves**. Wardrobe compartment on **right** includes hanging rod and **one adjustable shelf** above rod. Two upper locks secure storage and wardrobe compartments. Lower lock secures all drawers.

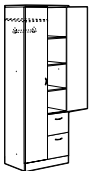

Personal Tower with Doors - RIGHT

Z36L8ER	24 x 36 x 84.4-84.9	125	368.55	50	\$2341	\$2399	\$1260	N/A
Z30L8ER	24 x 30 x 84.4-84.9	125	334.95	42	\$2137	\$2187	\$1149	N/A
Z24L8ER	24 x 24 x 84.4-84.9	100	299.24	34.25	\$2066	\$2108	\$992	N/A
Z36M8ER	20 x 36 x 84.4-84.9	125	332.85	42.25	\$2212	\$2262	\$1260	N/A
Z30M8ER	20 x 30 x 84.4-84.9	100	298.20	35.50	\$2039	\$2082	\$1149	N/A
Z24M8ER	20 x 24 x 84.4-84.9	100	266	29	\$1945	\$1979	\$992	N/A

Two file drawers on bottom. Laminate doors are standard. Storage compartment on **right includes three adjustable shelves**. Wardrobe compartment on **left** includes hanging rod and **one adjustable shelf** above rod. Two upper locks secure storage and wardrobe compartments. Lower lock secures all drawers.

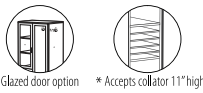
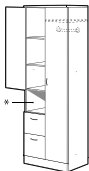

Personal Tower with Doors and cavity - LEFT

Z36L8ECL	24 x 36 x 84.4-84.9	125	366.44	50	\$2318	\$2375	\$1190	N/A
Z30L8ECL	24 x 30 x 84.4-84.9	125	332.49	42	\$2114	\$2164	\$1079	N/A
Z24L8ECL	24 x 24 x 84.4-84.9	100	295.24	34.25	\$2035	\$2076	\$922	N/A
Z36M8ECL	20 x 36 x 84.4-84.9	125	328.68	42.25	\$2178	\$2228	\$1190	N/A
Z30M8ECL	20 x 30 x 84.4-84.9	100	295.07	35.50	\$2006	\$2048	\$1079	N/A
Z24M8ECL	20 x 24 x 84.4-84.9	100	263	29	\$1913	\$1947	\$922	N/A

Two file drawers on bottom. Laminate doors are standard. Storage compartment on **left includes two 3-position fixed/height adjustable shelves**. Wardrobe compartment on **right** includes hanging rod and **one adjustable shelf** above rod. Two upper locks secure storage and wardrobe compartments. Lower lock secures all drawers.

Required Specifications

- Top finish
- Base finish
- Top/Edge Detail
- Handles

Optional Specifications

- Glazing - Doors
- Collator (Open Shelves)
- Box Drawer Option (no upcharge)

PERSONAL TOWERS - 84" / 84.5" HIGH

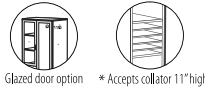
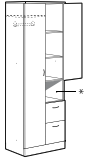

Personal Tower with Doors and cavity - RIGHT

MODEL#	DIMENSIONS	FREIGHT CLASS	WT/LBS.	CUBIC FT.	1" TOP	1.5" TOP	GLAZE ADD	HP ADD
D x W x H								
Z36L8ECR	24 x 36 x 84.4-84.9	125	366.44	50	\$2318	\$2375	\$1190	N/A
Z30L8ECR	24 x 30 x 84.4-84.9	125	332.49	42	\$2114	\$2164	\$1079	N/A
Z24L8ECR	24 x 24 x 84.4-84.9	100	295.24	34.25	\$2035	\$2076	\$922	N/A
Z36M8ECR	20 x 36 x 84.4-84.9	125	328.68	42.25	\$2178	\$2228	\$1190	N/A
Z30M8ECR	20 x 30 x 84.4-84.9	100	295.07	35.50	\$2006	\$2048	\$1079	N/A
Z24M8ECR	20 x 24 x 84.4-84.9	100	263	29	\$1913	\$1947	\$922	N/A

Two file drawers on bottom. Laminate doors are standard. Storage compartment on right includes two 3-position fixed/height adjustable shelves. Wardrobe compartment on left includes hanging rod and one adjustable shelf above rod. Two upper locks secure storage and wardrobe compartments. Lower lock secures all drawers.

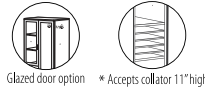
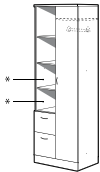

Personal Tower with Open Shelves - LEFT

Z36L8ENL	24 x 36 x 84.4-84.9	125	351.72	50	\$2192	\$2249	\$728	N/A
Z30L8ENL	24 x 30 x 84.4-84.9	125	320.22	42	\$1988	\$2038	\$616	N/A
Z24L8ENL	24 x 24 x 84.4-84.9	100	283.24	34.25	\$1886	\$1927	\$459	N/A
Z36M8ENL	20 x 36 x 84.4-84.9	125	313.96	42.25	\$2053	\$2103	\$724	N/A
Z30M8ENL	20 x 30 x 84.4-84.9	125	282.80	35.50	\$1881	\$1923	\$618	N/A
Z24M8ENL	20 x 24 x 84.4-84.9	100	249	29	\$1766	\$1800	\$459	N/A

Two file drawers on bottom. Laminate door is standard on wardrobe section. Storage compartment on left includes three 3-position fixed/height adjustable shelves. Wardrobe compartment on right includes hanging rod and one adjustable shelf above rod. Upper lock secures wardrobe compartment. Lower lock secures all drawers.

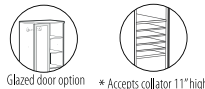
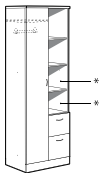

Personal Tower with Open Shelves - RIGHT

Z36L8ENR	24 x 36 x 84.4-84.9	125	351.72	50	\$2192	\$2249	\$728	N/A
Z30L8ENR	24 x 30 x 84.4-84.9	125	320.22	42	\$1988	\$2038	\$616	N/A
Z24L8ENR	24 x 24 x 84.4-84.9	100	283.24	34.25	\$1886	\$1927	\$459	N/A
Z36M8ENR	20 x 36 x 84.4-84.9	125	313.96	42.25	\$2053	\$2103	\$724	N/A
Z30M8ENR	20 x 30 x 84.4-84.9	125	282.80	35.50	\$1881	\$1923	\$618	N/A
Z24M8ENR	20 x 24 x 84.4-84.9	100	249	29	\$1766	\$1800	\$459	N/A

Two file drawers on bottom. Laminate door is standard on wardrobe section. Storage compartment on right includes three 3-position fixed/height adjustable shelves. Wardrobe compartment on right includes hanging rod and one adjustable shelf above rod. Upper lock secures wardrobe compartment. Lower lock secures all drawers.

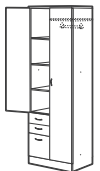

Personal Tower with Doors - LEFT

Z36L8BFL	24 x 36 x 84.4-84.9	125	371.70	50	\$2451	\$2508	\$1260	N/A
Z30L8BFL	24 x 30 x 84.4-84.9	100	337.05	42	\$2256	\$2306	\$1149	N/A
Z24L8BFL	24 x 24 x 84.4-84.9	100	301.24	34.25	\$2148	\$2189	\$992	N/A
Z36M8BFL	20 x 36 x 84.4-84.9	125	334.95	42.25	\$2312	\$2362	\$1260	N/A
Z30M8BFL	20 x 30 x 84.4-84.9	100	300.30	35.50	\$2148	\$2191	\$1149	N/A
Z24M8BFL	20 x 24 x 84.4-84.9	100	268	29	\$2027	\$2061	\$992	N/A

Two box and one file drawer on bottom. Laminate doors are standard. Storage compartment on left includes three 3-position fixed/height adjustable shelves. Wardrobe compartment on right includes hanging rod and one adjustable shelf above rod. Two upper locks secure storage and wardrobe compartments. Lower lock secures all drawers.

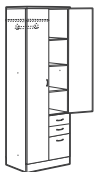

Personal Tower with Doors - RIGHT

Z36L8BFR	24 x 36 x 84.4-84.9	125	371.70	50	\$2451	\$2508	\$1260	N/A
Z30L8BFR	24 x 30 x 84.4-84.9	100	337.05	42	\$2256	\$2306	\$1149	N/A
Z24L8BFR	24 x 24 x 84.4-84.9	100	301.24	34.25	\$2148	\$2189	\$992	N/A
Z36M8BFR	20 x 36 x 84.4-84.9	125	334.95	42.25	\$2312	\$2362	\$1260	N/A
Z30M8BFR	20 x 30 x 84.4-84.9	100	300.30	35.50	\$2148	\$2191	\$1149	N/A
Z24M8BFR	20 x 24 x 84.4-84.9	100	268	29	\$2027	\$2061	\$992	N/A

Two box and one file drawer on bottom. Laminate doors are standard. Storage compartment on right includes three 3-position fixed/height adjustable shelves. Wardrobe compartment on left includes hanging rod and one adjustable shelf above rod. Two upper locks secure storage and wardrobe compartments. Lower lock secures all drawers.

Required Specifications

- Top finish
- Base finish
- Top/Edge Detail
- Handles

Optional Specifications

- Glazing - Doors
- Collator (Open Shelves)
- Box Drawer Option (no upcharge)

PERSONAL TOWERS - 84" / 84.5" HIGH

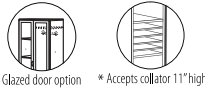
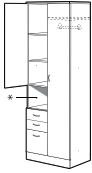

Personal Tower with Doors and Cavity - LEFT

MODEL#	DIMENSIONS D x W x H	FREIGHT CLASS	WT/LBS.	CUBIC FT.	1" TOP	1.5" TOP	GLAZE ADD	HP ADD
Z36L8BFCL	24 x 36 x 84.4-84.9	125	369.59	50	\$2418	\$2476	\$1190	N/A
Z30L8BFCL	24 x 30 x 84.4-84.9	125	334.59	42	\$2223	\$2273	\$1079	N/A
Z24L8BFCL	24 x 24 x 84.4-84.9	100	297.24	34.25	\$2114	\$2156	\$922	N/A
Z36M8BFCL	20 x 36 x 84.4-84.9	125	330.78	42.25	\$2279	\$2329	\$1190	N/A
Z30M8BFCL	20 x 30 x 84.4-84.9	100	299.27	35.50	\$2114	\$2157	\$1079	N/A
Z24M8BFCL	20 x 24 x 84.4-84.9	100	265	29	\$1995	\$2029	\$922	N/A

Two box and one file drawer on bottom. Laminate doors are standard. Storage compartment on left includes two 3-position fixed/height adjustable shelves. Wardrobe compartment on left includes hanging rod and one adjustable shelf above rod. Two upper locks secure storage and wardrobe compartments. Lower lock secures all drawers.

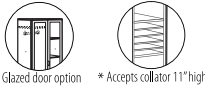
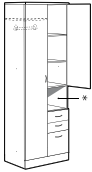

Personal Tower with Doors and Cavity - RIGHT

Z36L8BFCL	24 x 36 x 84.4-84.9	125	369.59	50	\$2418	\$2476	\$1190	N/A
Z30L8BFCL	24 x 30 x 84.4-84.9	125	334.59	42	\$2223	\$2273	\$1079	N/A
Z24L8BFCL	24 x 24 x 84.4-84.9	100	297.24	34.25	\$2114	\$2156	\$922	N/A
Z36M8BFCL	20 x 36 x 84.4-84.9	125	330.78	42.25	\$2279	\$2329	\$1190	N/A
Z30M8BFCL	20 x 30 x 84.4-84.9	100	299.27	35.50	\$2114	\$2157	\$1079	N/A
Z24M8BFCL	20 x 24 x 84.4-84.9	100	265	29	\$1995	\$2029	\$922	N/A

Two box and one file drawer on bottom. Laminate doors are standard. Storage compartment on right includes two 3-position fixed/height adjustable shelves. Wardrobe compartment on left includes hanging rod and one adjustable shelf above rod. Two upper locks secure storage and wardrobe compartments. Lower lock secures all drawers.

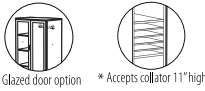
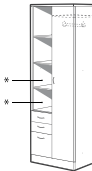

Personal Tower with Open Shelves - LEFT

Z36L8BFNL	24 x 36 x 84.4-84.9	125	354.87	50	\$2290	\$2348	\$728	N/A
Z30L8BFNL	24 x 30 x 84.4-84.9	125	322.32	42	\$2098	\$2148	\$616	N/A
Z24L8BFNL	24 x 24 x 84.4-84.9	100	285.24	34.25	\$1967	\$2008	\$459	N/A
Z36M8BFNL	20 x 36 x 84.4-84.9	125	316.06	42.25	\$2152	\$2212	\$724	N/A
Z30M8BFNL	20 x 30 x 84.4-84.9	100	287	35.50	\$1988	\$2031	\$618	N/A
Z24M8BFNL	20 x 24 x 84.4-84.9	100	251	29	\$1846	\$1880	\$459	N/A

Two box and one file drawer on bottom. Laminate door is standard on wardrobe section. Storage compartment on left includes three 3-position fixed/height adjustable shelves. Wardrobe compartment on right includes hanging rod and one adjustable shelf above rod. Upper lock secures storage and wardrobe compartments. Lower lock secures all drawers.

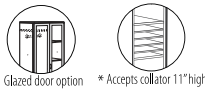
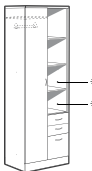

Personal Tower with Open Shelves - RIGHT

Z36L8BFNR	24 x 36 x 84.4-84.9	125	354.87	50	\$2290	\$2348	\$728	N/A
Z30L8BFNR	24 x 30 x 84.4-84.9	125	322.32	42	\$2098	\$2148	\$616	N/A
Z24L8BFNR	24 x 24 x 84.4-84.9	100	285.24	34.25	\$1967	\$2008	\$459	N/A
Z36M8BFNR	20 x 36 x 84.4-84.9	125	316.06	42.25	\$2152	\$2212	\$724	N/A
Z30M8BFNR	20 x 30 x 84.4-84.9	100	287	35.50	\$1988	\$2031	\$618	N/A
Z24M8BFNR	20 x 24 x 84.4-84.9	100	251	29	\$1846	\$1880	\$459	N/A

Two box and one file drawer on bottom. Laminate door is standard on wardrobe section. Storage compartment on right includes three 3-position fixed/height adjustable shelves. Wardrobe compartment on left includes hanging rod and one adjustable shelf above rod. Upper lock secures storage and wardrobe compartments. Lower lock secures all drawers.

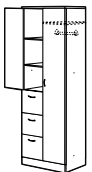

Personal Tower with Doors - LEFT

Z36L83FL	24 x 36 x 84.4-84.9	125	374.85	50	\$2491	\$2549	\$1190	N/A
Z30L83FL	24 x 30 x 84.4-84.9	100	340.20	42	\$2298	\$2348	\$1079	N/A
Z24L83FL	24 x 24 x 84.4-84.9	100	304.24	34.25	\$2207	\$2248	\$922	N/A
Z36M83FL	20 x 36 x 84.4-84.9	100	339.15	42.25	\$2318	\$2368	\$1190	N/A
Z30M83FL	20 x 30 x 84.4-84.9	100	306.60	35.50	\$2167	\$2210	\$1079	N/A
Z24M83FL	20 x 24 x 84.4-84.9	100	272	29	\$2078	\$2114	\$922	N/A

Three file drawers on bottom. Laminate doors are standard. Storage compartment on left includes two 3-position fixed/height adjustable shelves. Wardrobe compartment on right includes hanging rod and one adjustable shelf above rod. Two upper locks secure storage and wardrobe compartments. Lower lock secures all drawers.

Required Specifications

- Top finish
- Base finish
- Top/Edge Detail
- Handles

Optional Specifications

- Glazing - Doors
- Collator (Open Shelves)
- Box Drawer Option (no upcharge)

PERSONAL TOWERS - 84" / 84.5" HIGH

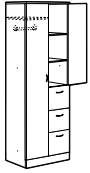

Glazed door option

Personal Tower with Doors - RIGHT

MODEL#	DIMENSIONS D x W x H	FREIGHT CLASS	WT/LBS.	CUBIC FT.	1" TOP	1.5" TOP	GLAZE ADD	HP ADD
Z36L83FR	24 x 36 x 84.4-84.9	125	374.85	50	\$2491	\$2549	\$1190	N/A
Z30L83FR	24 x 30 x 84.4-84.9	100	340.20	42	\$2298	\$2348	\$1079	N/A
Z24L83FR	24 x 24 x 84.4-84.9	100	304.24	34.25	\$2207	\$2248	\$922	N/A
Z36M83FR	20 x 36 x 84.4-84.9	100	339.15	42.25	\$2318	\$2368	\$1190	N/A
Z30M83FR	20 x 30 x 84.4-84.9	100	306.60	35.50	\$2167	\$2210	\$1079	N/A
Z24M83FR	20 x 24 x 84.4-84.9	100	272	29	\$2078	\$2114	\$922	N/A

Three file drawers on bottom. Laminate doors are standard. Storage compartment on right includes two 3-position fixed/height adjustable shelves. Wardrobe compartment on left includes hanging rod and one adjustable shelf above rod. Two upper locks secure storage and wardrobe compartments. Lower lock secures all drawers.

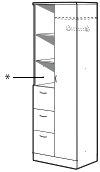

Glazed door option * Accepts collator 11" high

Personal Tower with Open Shelves - LEFT

Z36L83FNL	24 x 36 x 84.4-84.9	125	362.01	50	\$2364	\$2422	\$728	N/A
Z30L83FNL	24 x 30 x 84.4-84.9	125	328.80	42	\$2172	\$2222	\$616	N/A
Z24L83FNL	24 x 24 x 84.4-84.9	100	291.24	34.25	\$2058	\$2100	\$459	N/A
Z36M83FNL	20 x 36 x 84.4-84.9	125	324.25	42.25	\$2192	\$2242	\$724	N/A
Z30M83FNL	20 x 30 x 84.4-84.9	100	294.53	35.50	\$2040	\$2083	\$618	N/A
Z24M83FNL	20 x 24 x 84.4-84.9	100	258	29	\$1930	\$1964	\$459	N/A

Three file drawers on bottom. Laminate door is standard on wardrobe section. Storage compartment on left includes two 3-position fixed/height adjustable shelves. Wardrobe compartment on right includes hanging rod and one adjustable shelf above rod. Upper lock secures wardrobe compartment. Lower lock secures all drawers.

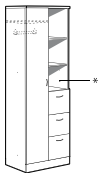

Glazed door option * Accepts collator 11" high

Personal Tower with Open Shelves - RIGHT

Z36L83FNR	24 x 36 x 84.4-84.9	125	362.01	50	\$2364	\$2422	\$728	N/A
Z30L83FNR	24 x 30 x 84.4-84.9	125	328.80	42	\$2172	\$2222	\$616	N/A
Z24L83FNR	24 x 24 x 84.4-84.9	100	291.24	34.25	\$2058	\$2100	\$459	N/A
Z36M83FNR	20 x 36 x 84.4-84.9	125	324.25	42.25	\$2192	\$2242	\$724	N/A
Z30M83FNR	20 x 30 x 84.4-84.9	100	294.53	35.50	\$2040	\$2083	\$618	N/A
Z24M83FNR	20 x 24 x 84.4-84.9	100	258	29	\$1930	\$1964	\$459	N/A

Three file drawers on bottom. Laminate door is standard on wardrobe section. Storage compartment on right includes two 3-position fixed/height adjustable shelves. Wardrobe compartment on left includes hanging rod and one adjustable shelf above rod. Upper lock secures wardrobe compartment. Lower lock secures all drawers.

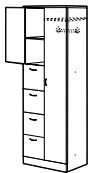

Glazed door option

Personal Tower with Doors - LEFT

Z36L84FL	24 x 36 x 84.4-84.9	125	380.10	50	\$2569	\$2627	\$1089	N/A
Z30L84FL	24 x 30 x 84.4-84.9	100	344.40	42	\$2377	\$2427	\$977	N/A
Z24L84FL	24 x 24 x 84.4-84.9	100	309.24	34.25	\$2226	\$2267	\$820	N/A
Z36M84FL	20 x 36 x 84.4-84.9	100	344.40	42.25	\$2400	\$2450	\$1089	N/A
Z30M84FL	20 x 30 x 84.4-84.9	100	312.90	35.50	\$2248	\$2291	\$977	N/A
Z24M84FL	20 x 24 x 84.4-84.9	100	278	29	\$2124	\$2160	\$820	N/A

Four file drawers on bottom. Laminate doors are standard. Storage compartment on left includes one 3-position fixed/height adjustable shelf. Wardrobe compartment on right includes hanging rod and one adjustable shelf above rod. Two upper locks secure wardrobe compartment. Lower lock secures all drawers.



Glazed door option

Personal Tower with Doors - RIGHT

Z36L84FR	24 x 36 x 84.4-84.9	125	380.10	50	\$2569	\$2627	\$1089	N/A
Z30L84FR	24 x 30 x 84.4-84.9	100	344.40	42	\$2377	\$2427	\$977	N/A
Z24L84FR	24 x 24 x 84.4-84.9	100	309.24	34.25	\$2226	\$2267	\$820	N/A
Z36M84FR	20 x 36 x 84.4-84.9	100	344.40	42.25	\$2400	\$2450	\$1089	N/A
Z30M84FR	20 x 30 x 84.4-84.9	100	312.90	35.50	\$2248	\$2291	\$977	N/A
Z24M84FR	20 x 24 x 84.4-84.9	100	278	29	\$2124	\$2160	\$820	N/A

Four file drawers on bottom. Laminate doors are standard. Storage compartment on right includes one 3-position fixed/height adjustable shelf. Wardrobe compartment on left includes hanging rod and one adjustable shelf above rod. Two upper locks secure wardrobe compartment. Lower lock secures all drawers.

Required Specifications

Top finish
Base finish
Top/Edge Detail
Handles

Optional Specifications

Glazing - Doors
Collator (Open Shelves)
Box Drawer Option (no upcharge)

PERSONAL TOWERS - 84" / 84.5" HIGH

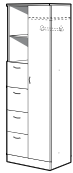

Glazed door option

Personal Tower with Open Shelf - LEFT

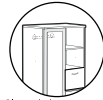

Glazed door option

Personal Tower with Open Shelf - RIGHT

MODEL#	DIMENSIONS D x W x H	FREIGHT CLASS	WT/LBS.	CUBIC FT.	1" TOP	1.5" TOP	GLAZE ADD	HP ADD
Z36L84FNL	24 x 36 x 84.4-84.9	125	371.25	50	\$2465	\$2523	\$728	N/A
Z30L84FNL	24 x 30 x 84.4-84.9	100	336.33	42	\$2273	\$2323	\$616	N/A
Z24L84FNL	24 x 24 x 84.4-84.9	100	299.24	34.25	\$2134	\$2186	\$459	N/A
Z36M84FNL	20 x 36 x 84.4-84.9	125	328.24	42.25	\$2298	\$2348	\$724	N/A
Z30M84FNL	20 x 30 x 84.4-84.9	100	297.86	35.50	\$2146	\$2189	\$618	N/A
Z24M84FNL	20 x 24 x 84.4-84.9	100	268	29	\$2032	\$2068	\$459	N/A

Four file drawers on bottom. Laminate door is standard on wardrobe section. Storage compartment on left includes one 3-position fixed/height adjustable shelf. Wardrobe compartment on right includes hanging rod and one adjustable shelf above rod. Upper lock secures wardrobe compartment. Lower lock secures all drawers.

Z36L84FNR	24 x 36 x 84.4-84.9	125	371.25	50	\$2465	\$2523	\$728	N/A
Z30L84FNR	24 x 30 x 84.4-84.9	100	336.33	42	\$2273	\$2323	\$616	N/A
Z24L84FNR	24 x 24 x 84.4-84.9	100	299.24	34.25	\$2134	\$2186	\$459	N/A
Z36M84FNR	20 x 36 x 84.4-84.9	125	328.24	42.25	\$2298	\$2348	\$724	N/A
Z30M84FNR	20 x 30 x 84.4-84.9	100	297.86	35.50	\$2146	\$2189	\$618	N/A
Z24M84FNR	20 x 24 x 84.4-84.9	100	268	29	\$2032	\$2068	\$459	N/A

Four file drawers on bottom. Laminate door is standard on wardrobe section. Storage compartment on right includes one 3-position fixed/height adjustable shelf. Wardrobe compartment on left includes hanging rod and one adjustable shelf above rod. Upper lock secures wardrobe compartment. Lower lock secures all drawers.

CLOSED FRONT OVERHEAD STORAGE - 33"H

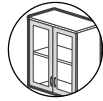
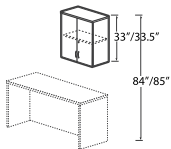

Glazed door option

Closed Front Overhead Storage with Doors - 32.5"/33"H

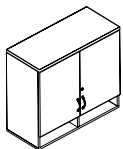

Glazed door option

Closed Front Overhead Storage with Pigeon Hole - 32.5"/33"H

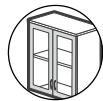
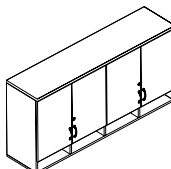

Glazed door option

Closed Front Overhead Storage with Pigeon Hole - 32.5"/33"H

MODEL#	DIMENSIONS	FREIGHT CLASS	WT/LBS.	CUBIC FT.	1" TOP	1.5" TOP	GLAZE ADD	HP ADD
Z42S33OS	16 x 42 x 32.5-33	100	135.98	16.25	\$856	\$912	\$831	N/A
Z36S33OS	16 x 36 x 32.5-33	100	119.70	14	\$777	\$826	\$749	N/A
Z30S33OS	16 x 30 x 32.5-33	100	104.42	11.75	\$695	\$725	\$654	N/A
Z24S33OS	16 x 24 x 32.5-33	100	81.13	9.75	\$623	\$656	\$571	N/A

Includes steel hanging rail for wall mount applications. Includes one fixed shelf. Doors lock.

• **NOTE:** Care should be taken to mount the units. Units should be mounted to wall studs using correct fasteners. Failure to do so may result in collapse of the unit and subsequent personal injury. **Fastening hardware not included.** Mounting hardware used should be based on wall material. Consult an installation professional for proper wall mounting.

Z42S33OP	16 x 42 x 32.5-33	100	140	16.25	\$1093	\$1150	\$547	N/A
Z36S33OP	16 x 36 x 32.5-33	100	122	14	\$945	\$997	\$498	N/A
Z30S33OP	16 x 30 x 32.5-33	100	105	12	\$846	\$888	\$443	N/A
Z24S33OP	16 x 24 x 32.5-33	100	88	9.75	\$760	\$799	\$402	N/A

Includes steel hanging rail for wall mount applications. Includes one fixed shelf. Doors lock.

• **NOTE:** Care should be taken to mount the units. Units should be mounted to wall studs using correct fasteners. Failure to do so may result in collapse of the unit and subsequent personal injury. **Fastening hardware not included.** Mounting hardware used should be based on wall material. Consult an installation professional for proper wall mounting.

Z72S33OS	16 x 72 x 32.5-33	100	230	26	\$1772	\$1848	\$999	N/A
Z66S33OS	16 x 66 x 32.5-33	100	215	24	\$1703	\$1773	\$981	N/A
Z60S33OS	16 x 60 x 32.5-33	100	199	22	\$1570	\$1634	\$889	N/A
Z54S33OS	16 x 54 x 32.5-33	100	184	21	\$1492	\$1552	\$871	N/A

Includes steel hanging rail for wall mount applications. Includes one fixed shelf. Doors lock.

• **NOTE:** Care should be taken to mount the units. Units should be mounted to wall studs using correct fasteners. Failure to do so may result in collapse of the unit and subsequent personal injury. **Fastening hardware not included.** Mounting hardware used should be based on wall material. Consult an installation professional for proper wall mounting.

Required Specifications

- Top finish
- Base finish
- Top/Edge Detail
- Handles

Optional Specifications

- Glazing - Doors
- Box Drawer Option (no upcharge - Towers)

OVERHEAD STORAGE - 33"H

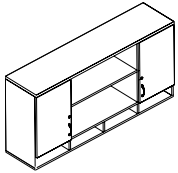

Glazed door option

Overhead Storage, 2 Outer Doors with Pigeon Hole - 32.5"/33"H

MODEL#	DIMENSIONS D x W x H	FREIGHT CLASS	WT/LBS.	CUBIC FT.	1" TOP	1.5" TOP	GLAZE ADD	HP ADD
Z72S33SOS	16 x 72 x 32.5-33	100	215	26	\$1602	\$1678	\$500	N/A
Z66S33SOS	16 x 66 x 32.5-33	100	201	24	\$1530	\$1600	\$491	N/A
Z60S33SOS	16 x 60 x 32.5-33	100	187	22	\$1437	\$1501	\$482	N/A
Z54S33SOS	16 x 54 x 32.5-33	100	173	21	\$1337	\$1397	\$436	N/A

6 compartments. **Doors on outer compartments only.** Includes steel hanging rail for wall mount applications. Includes one fixed shelf. Doors lock.

• **NOTE:** Care should be taken to mount the units. Units should be mounted to wall studs using correct fasteners. Failure to do so may result in collapse of the unit and subsequent personal injury. **Fastening hardware not included.** Mounting hardware used should be based on wall material. Consult an installation professional for proper wall mounting.

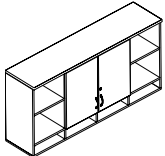

Glazed door option

Overhead Storage, 2 Center Doors with Pigeon Hole - 32.5"/33"H

Z72S33OSO	16 x 72 x 32.5-33	100	214	26	\$1572	\$1648	\$500	N/A
Z66S33OSO	16 x 66 x 32.5-33	100	200	24	\$1504	\$1574	\$491	N/A
Z60S33OSO	16 x 60 x 32.5-33	100	186	22	\$1411	\$1475	\$445	N/A
Z54S33OSO	16 x 54 x 32.5-33	100	172	21	\$1334	\$1394	\$436	N/A

6 compartments. **Doors on inner compartments only.** Includes steel hanging rail for wall mount applications. Includes one fixed shelf. Doors lock.

• **NOTE:** Care should be taken to mount the units. Units should be mounted to wall studs using correct fasteners. Failure to do so may result in collapse of the unit and subsequent personal injury. **Fastening hardware not included.** Mounting hardware used should be based on wall material. Consult an installation professional for proper wall mounting.

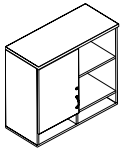

Glazed door option

Overhead Storage, 1 Door - LEFT with Pigeon Hole - 32.5"/33"H

Z36S33OSL	16 x 36 x 32.5-33	100	119	14	\$884	\$936	\$249	N/A
Z30S33OSL	16 x 30 x 32.5-33	100	104	11.75	\$806	\$848	\$222	N/A
Z24S33OSL	16 x 24 x 32.5-33	100	88	9.75	\$724	\$763	\$194	N/A

Includes steel hanging rail for wall mount applications. Includes one fixed shelf. Door locks. Open storage on **right.**

• **NOTE:** Care should be taken to mount the units. Units should be mounted to wall studs using correct fasteners. Failure to do so may result in collapse of the unit and subsequent personal injury. **Fastening hardware not included.** Mounting hardware used should be based on wall material. Consult an installation professional for proper wall mounting.

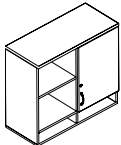

Glazed door option

Overhead Storage, 1 Door - RIGHT with Pigeon Hole - 32.5"/33"H

Z36S33OSR	16 x 36 x 32.5-33	100	119	14	\$884	\$936	\$249	N/A
Z30S33OSR	16 x 30 x 32.5-33	100	104	11.75	\$806	\$848	\$222	N/A
Z24S33OSR	16 x 24 x 32.5-33	100	88	9.75	\$724	\$763	\$194	N/A

Includes steel hanging rail for wall mount applications. Includes one fixed shelf. Door locks. Open storage on **left.**

• **NOTE:** Care should be taken to mount the units. Units should be mounted to wall studs using correct fasteners. Failure to do so may result in collapse of the unit and subsequent personal injury. **Fastening hardware not included.** Mounting hardware used should be based on wall material. Consult an installation professional for proper wall mounting.

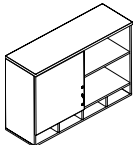

Glazed door option

Overhead Storage, 1 Door - LEFT with Pigeon Hole - 32.5"/33"H

Z48S33OSL	16 x 48 x 32.5-33	100	135	16.25	\$1145	\$1205	\$281	N/A
Z42S33OSL	16 x 42 x 32.5-33	100	135	16.25	\$1018	\$1075	\$274	N/A

Includes steel hanging rail for wall mount applications. Includes one fixed shelf. Door locks. Open storage on **right.**

• **NOTE:** Care should be taken to mount the units. Units should be mounted to wall studs using correct fasteners. Failure to do so may result in collapse of the unit and subsequent personal injury. **Fastening hardware not included.** Mounting hardware used should be based on wall material. Consult an installation professional for proper wall mounting.

Required Specifications

Top finish
Base finish
Top/Edge Detail
Handles

Optional Specifications

Glazing - Doors (Closed Storage)

CLOSED FRONT OVERHEAD STORAGE - 33"H

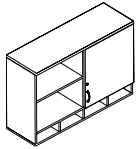

Glazed door option

Overhead Storage, 1 Door - RIGHT with Pigeon Hole - 32.5"/33"H*

MODEL#	DIMENSIONS D x W x H	FREIGHT CLASS	WT/LBS.	CUBIC FT.	1" TOP	1.5" TOP	GLAZE ADD	HP ADD
Z48S33OSR	16 x 48 x 32.5-33	100	135	16.25	\$1145	\$1205	\$281	N/A
Z42S33OSR	16 x 42 x 32.5-33	100	135	16.25	\$1018	\$1075	\$274	N/A

Includes steel hanging rail for wall mount applications. Includes one fixed shelf. Door locks. Open storage on **left**.

• **NOTE:** Care should be taken to mount the units. Units should be mounted to wall studs using correct fasteners. Failure to do so may result in collapse of the unit and subsequent personal injury. **Fastening hardware not included.** Mounting hardware used should be based on wall material. Consult an installation professional for proper wall mounting.

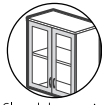
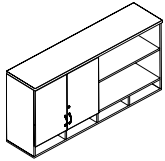

Glazed door option

Overhead Storage, 1 Door - LEFT with Pigeon Hole - 32.5"/33"H*

Z72S33OSL	16 x 72 x 32.5-33	125	207	26	\$1539	\$1615	\$499	N/A
Z66S33OSL	16 x 66 x 32.5-33	100	193	24	\$1469	\$1539	\$492	N/A
Z60S33OSL	16 x 60 x 32.5-33	100	179	22	\$1361	\$1425	\$446	N/A
Z54S33OSL	16 x 54 x 32.5-33	125	166	21	\$1287	\$1347	\$434	N/A

Includes steel hanging rail for wall mount applications. Includes one fixed shelf. Doors lock. Open storage on **right**.

• **NOTE:** Care should be taken to mount the units. Units should be mounted to wall studs using correct fasteners. Failure to do so may result in collapse of the unit and subsequent personal injury. **Fastening hardware not included.** Mounting hardware used should be based on wall material. Consult an installation professional for proper wall mounting.

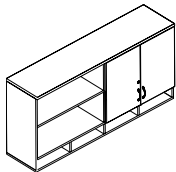

Glazed door option

Overhead Storage, 1 Door - RIGHT with Pigeon Hole - 32.5"/33"H*

Z72S33OSR	16 x 72 x 32.5-33	125	207	26	\$1539	\$1615	\$499	N/A
Z66S33OSR	16 x 66 x 32.5-33	100	193	24	\$1469	\$1539	\$492	N/A
Z60S33OSR	16 x 60 x 32.5-33	100	179	22	\$1361	\$1425	\$446	N/A
Z54S33OSR	16 x 54 x 32.5-33	125	166	21	\$1287	\$1347	\$434	N/A

Includes steel hanging rail for wall mount applications. Includes one fixed shelf. Doors lock. Open storage on **left**.

• **NOTE:** Care should be taken to mount the units. Units should be mounted to wall studs using correct fasteners. Failure to do so may result in collapse of the unit and subsequent personal injury. **Fastening hardware not included.** Mounting hardware used should be based on wall material. Consult an installation professional for proper wall mounting.

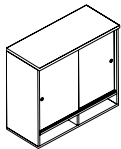

Overhead Storage, Glass Doors with Pigeon Hole - 32.5"/33"H

Z36S33OSD	16 x 36 x 32.5-33	100	127	14	\$1878	\$1930	N/A	N/A
Z30S33OSD	16 x 30 x 32.5-33	100	110	12	\$1652	\$1694	N/A	N/A
Z24S33OSD	16 x 24 x 32.5-33	100	91	9.75	\$1464	\$1503	N/A	N/A

Includes steel hanging rail for wall mount applications. Includes one fixed shelf. Sliding glass doors do not lock.

• **NOTE:** Care should be taken to mount the units. Units should be mounted to wall studs using correct fasteners. Failure to do so may result in collapse of the unit and subsequent personal injury. **Fastening hardware not included.** Mounting hardware used should be based on wall material. Consult an installation professional for proper wall mounting.

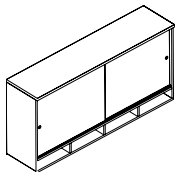

Overhead Storage, Glass Doors with Pigeon Hole - 32.5"/33"H

Z72S33OSD	16 x 72 x 32.5-33	100	224	26	\$3311	\$3387	N/A	N/A
Z66S33OSD	16 x 66 x 32.5-33	100	208	24	\$3096	\$3166	N/A	N/A
Z60S33OSD	16 x 60 x 32.5-33	100	193	22	\$2864	\$2928	N/A	N/A
Z54S33OSD	16 x 54 x 32.5-33	100	178	21	\$2668	\$2728	N/A	N/A
Z48S33OSD	16 x 48 x 32.5-33	100	162	17.70	\$2437	\$2497	N/A	N/A
Z42S33OSD	16 x 42 x 32.5-33	100	145	16.25	\$2178	\$2235	N/A	N/A

Includes steel hanging rail for wall mount applications. Includes one fixed shelf. Sliding glass doors do not lock.

• **NOTE:** Care should be taken to mount the units. Units should be mounted to wall studs using correct fasteners. Failure to do so may result in collapse of the unit and subsequent personal injury. **Fastening hardware not included.** Mounting hardware used should be based on wall material. Consult an installation professional for proper wall mounting.

Required Specifications

Top finish _____ Handles _____
 Top/edge detail _____
 Base finish _____
 Lock finish*

Optional Specifications

Glazed doors* _____
 Key #* _____

CLOSED FRONT OVERHEAD STORAGE - 20" H

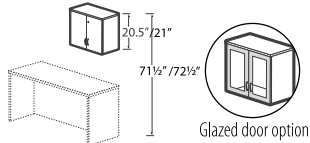

Closed Front Overhead Storage with Doors - 20"/20.5"H*

MODEL#	DIMENSIONS D x W x H	FREIGHT CLASS	WT/LBS.	CUBIC FT.	1" TOP	1.5" TOP	GLAZE ADD	HP ADD
Z42S200S	16 x 42 x 20-20.5	100	93.99	10.50	\$612	\$667	\$592	N/A
Z36S200S	16 x 36 x 20-20.5	100	82.70	9	\$560	\$609	\$541	N/A
Z30S200S	16 x 30 x 20-20.5	100	72.42	7.50	\$506	\$536	\$480	N/A
Z24S200S	16 x 24 x 20-20.5	100	56.13	6.25	\$474	\$508	\$429	N/A

Includes steel hanging rail for wall mount applications. Doors lock.

- **NOTE:** Care should be taken to mount the units. Units should be mounted to wall studs using correct fasteners. Failure to do so may result in collapse of the unit and subsequent personal injury. **Fastening hardware not included.** Mounting hardware used should be based on wall material. Consult an installation professional for proper wall mounting.

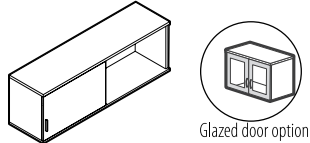

Overhead Storage w/1 door - LEFT* 20"/20.5"H

Z48S200SL	16 x 48 x 20-20.5	125	95	12.50	\$695	\$755	\$240	N/A
Z42S200SL	16 x 42 x 20-20.5	100	85	10.50	\$615	\$672	\$222	N/A
Z36S200SL	16 x 36 x 20-20.5	100	76	9	\$563	\$615	\$203	N/A
Z30S200SL	16 x 30 x 20-20.5	100	67	7.60	\$516	\$558	\$174	N/A
Z24S200SL	16 x 24 x 20-20.5	100	58	6.50	\$477	\$516	\$160	N/A

Door on **left**. Includes steel hanging rail for wall mount applications. Includes one fixed shelf. Door locks.

- **NOTE:** Care should be taken to mount the units. Units should be mounted to wall studs using correct fasteners. Failure to do so may result in collapse of the unit and subsequent personal injury. **Fastening hardware not included.** Mounting hardware used should be based on wall material. Consult an installation professional for proper wall mounting.

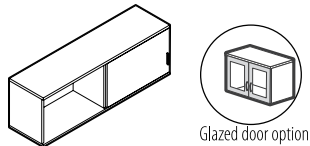

Overhead Storage w/1 door - RIGHT 20"/20.5"H*

Z48S200SR	16 x 48 x 20-20.5	125	95	12.50	\$695	\$755	\$240	N/A
Z42S200SR	16 x 42 x 20-20.5	100	85	10.50	\$615	\$672	\$222	N/A
Z36S200SR	16 x 36 x 20-20.5	100	76	9	\$563	\$615	\$203	N/A
Z30S200SR	16 x 30 x 20-20.5	100	67	7.60	\$516	\$558	\$174	N/A
Z24S200SR	16 x 24 x 20-20.5	100	58	6.50	\$477	\$516	\$160	N/A

Door on **right**. Includes steel hanging rail for wall mount applications. Includes one fixed shelf. Door locks.

- **NOTE:** Care should be taken to mount the units. Units should be mounted to wall studs using correct fasteners. Failure to do so may result in collapse of the unit and subsequent personal injury. **Fastening hardware not included.** Mounting hardware used should be based on wall material. Consult an installation professional for proper wall mounting.

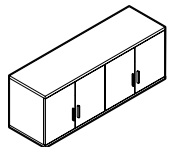

Closed Front Overhead Storage w/Center Divider- 20/20.5"H*

Z72S200S	16 x 72 x 20-20.5	100	149	18	\$1173	\$1249	\$808	N/A
Z66S200S	16 x 66 x 20-20.5	100	139	16.50	\$1118	\$1188	\$790	N/A
Z60S200S	16 x 60 x 20-20.5	100	129	15	\$1032	\$1096	\$723	N/A
Z54S200S	16 x 54 x 20-20.5	100	119	13.75	\$982	\$1042	\$704	N/A

Includes steel hanging rail for wall mount applications. Includes one fixed shelf. Doors lock.

- **NOTE:** Care should be taken to mount the units. Units should be mounted to wall studs using correct fasteners. Failure to do so may result in collapse of the unit and subsequent personal injury. **Fastening hardware not included.** Mounting hardware used should be based on wall material. Consult an installation professional for proper wall mounting.

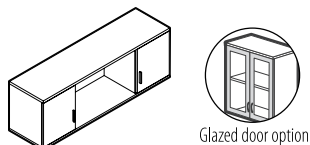

Overhead Storage w/2 Outer Doors 20/20.5"H*

Z72S20SOS	16 x 72 x 20-20.5	125	137	18	\$1007	\$1083	\$407	N/A
Z66S20SOS	16 x 66 x 20-20.5	125	128	16.50	\$954	\$1024	\$398	N/A
Z60S20SOS	16 x 60 x 20-20.5	100	120	15	\$897	\$961	\$389	N/A
Z54S20SOS	16 x 54 x 20-20.5	100	110	13.75	\$836	\$896	\$355	N/A

4 compartments. **Doors on outer compartments only.** Includes steel hanging rail for wall mount applications. Doors lock.

- **NOTE:** Care should be taken to mount the units. Units should be mounted to wall studs using correct fasteners. Failure to do so may result in collapse of the unit and subsequent personal injury. **Fastening hardware not included.** Mounting hardware used should be based on wall material. Consult an installation professional for proper wall mounting.

Required Specifications

- Top finish
- Top/edge detail
- Base finish
- Lock finish*
- Handles*

Optional Specifications

- Glazed doors*
- Key #*

CLOSED FRONT OVERHEAD STORAGE - 20"H

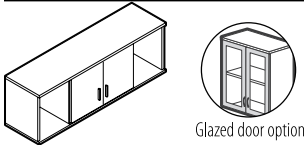

Overhead Storage w/2 Inner Doors 20/20.5"H*

MODEL#	DIMENSIONS D x W x H	FREIGHT CLASS	WT./LBS.	CUBIC FT.	1" TOP	1.5" TOP	GLAZE ADD	HP ADD
Z72S200SO	16 x 72 x 20-20.5	125	137	18	\$1019	\$1095	\$404	N/A
Z66S200SO	16 x 66 x 20-20.5	125	128	16.50	\$966	\$1036	\$395	N/A
Z60S200SO	16 x 60 x 20-20.5	100	120	15	\$909	\$973	\$362	N/A
Z54S200SO	16 x 54 x 20-20.5	100	110	13.75	\$848	\$908	\$352	N/A

4 compartments. **Doors on inner compartments only.** Includes steel hanging rail for wall mount applications. Doors lock.
NOTE: Care should be taken to mount the units. Units should be mounted to wall studs using correct fasteners. Failure to do so may result in collapse of the unit and subsequent personal injury. **Fastening hardware not included.** Mounting hardware used should be based on wall material. Consult an installation professional for proper wall mounting.

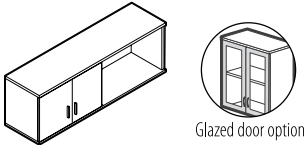

Overhead Storage w/2 Doors - LEFT 20/20.5"H*

Z72S200SL	16 x 72 x 20-20.5	125	132	18	\$977	\$1053	\$405	N/A
Z66S200SL	16 x 66 x 20-20.5	125	123	16.50	\$924	\$994	\$396	N/A
Z60S200SL	16 x 60 x 20-20.5	125	114	15	\$854	\$918	\$363	N/A
Z54S200SL	16 x 54 x 20-20.5	125	105	13.75	\$806	\$866	\$353	N/A

2 doors on **left** cavity. Includes steel hanging rail for wall mount applications. Includes one fixed shelf. Doors lock.
NOTE: Care should be taken to mount the units. Units should be mounted to wall studs using correct fasteners. Failure to do so may result in collapse of the unit and subsequent personal injury. **Fastening hardware not included.** Mounting hardware used should be based on wall material. Consult an installation professional for proper wall mounting.

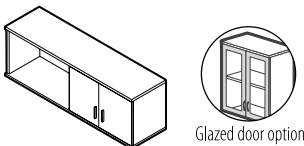

Overhead Storage w/2 Doors - RIGHT 20/20.5"H*

Z72S200SR	16 x 72 x 20-20.5	125	132	18	\$977	\$1053	\$405	N/A
Z66S200SR	16 x 66 x 20-20.5	125	123	16.50	\$924	\$994	\$396	N/A
Z60S200SR	16 x 60 x 20-20.5	125	114	15	\$854	\$918	\$363	N/A
Z54S200SR	16 x 54 x 20-20.5	125	105	13.75	\$806	\$866	\$353	N/A

2 doors on **right** cavity. Includes steel hanging rail for wall mount applications. Includes one fixed shelf. Doors lock.
NOTE: Care should be taken to mount the units. Units should be mounted to wall studs using correct fasteners. Failure to do so may result in collapse of the unit and subsequent personal injury. **Fastening hardware not included.** Mounting hardware used should be based on wall material. Consult an installation professional for proper wall mounting.

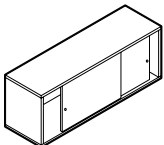

Overhead Storage, w/Glass Doors 20/20.5"H

Z72S200SD	16 x 72 x 20-20.5	100	145	18	\$2475	\$2551	N/A	N/A
Z66S200SD	16 x 66 x 20-20.5	100	135	16	\$2305	\$2375	N/A	N/A
Z60S200SD	16 x 60 x 20-20.5	100	125	15	\$2125	\$2189	N/A	N/A
Z54S200SD	16 x 54 x 20-20.5	100	115	13.75	\$2034	\$2094	N/A	N/A
Z48S200SD	16 x 48 x 20-20.5	100	104	12.50	\$1798	\$1858	N/A	N/A
Z42S200SD	16 x 42 x 20-20.5	100	93	10.50	\$1606	\$1663	N/A	N/A
Z36S200SD	16 x 36 x 20-20.5	100	83	9	\$1420	\$1472	N/A	N/A
Z30S200SD	16 x 30 x 20-20.5	100	75	7.60	\$1271	\$1313	N/A	N/A
Z24S200SD	16 x 24 x 20-20.5	100	63	6.40	\$1177	\$1216	N/A	N/A

Includes steel hanging rail for wall mount applications. Sliding glass doors do not lock.
NOTE: Care should be taken to mount the units. Units should be mounted to wall studs using correct fasteners. Failure to do so may result in collapse of the unit and subsequent personal injury. **Fastening hardware not included.** Mounting hardware used should be based on wall material. Consult an installation professional for proper wall mounting.

CLOSED FRONT OVERHEAD STORAGE - 16"H

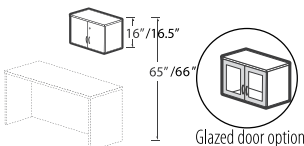

Closed Front Overhead Storage with Doors - 16"/16.5"H*

MODEL#	DIMENSIONS	FREIGHT CLASS	WT./LBS.	CUBIC FT.	1" TOP	1.5" TOP	GLAZE ADD	HP ADD
Z48S160S	15 x 48 x 16-16.5	92.5	98.63	9.25	\$610	\$662	\$571	N/A
Z42S160S	15 x 42 x 16-16.5	92.5	87.42	7.75	\$529	\$574	\$553	N/A
Z36S160S	15 x 36 x 16-16.5	92.5	77.22	6.75	\$483	\$523	\$499	N/A
Z30S160S	15 x 30 x 16-16.5	92.5	64.02	5.75	\$440	\$474	\$437	N/A

Standard with pre-mounted "J" bracket for wall mount applications. Doors lock.
NOTE: Care should be taken to mount the units. Units should be mounted to wall studs using correct fasteners. Failure to do so may result in collapse of the unit and subsequent personal injury. **Fastening hardware not included.** Mounting hardware used should be based on wall material. Consult an installation professional for proper wall mounting.

Required Specifications

Top finish _____ Handles _____
 Top/edge detail _____
 Base finish _____
 Lock finish* _____

Optional Specifications

Glazed doors* _____
 Key #* _____

CLOSED FRONT OVERHEAD STORAGE - 16" H

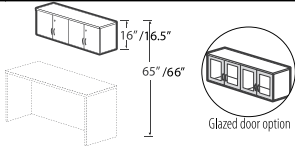

Closed Front Overhead Storage with Doors - 16"/16.5" High, 60" Wide

MODEL#	DIMENSIONS	FREIGHT CLASS	WT/LBS.	CUBIC FT.	1" TOP	1.5" TOP	GLAZE ADD	HP ADD
Z60S160S	15 x 60 x 16-16.5	92.5	118.03	11	\$802	\$864	\$872	N/A

Standard with pre-mounted "J" bracket for wall mount applications. Doors lock.

- **NOTE:** Care should be taken to mount the units. Units should be mounted to wall studs using correct fasteners. Failure to do so may result in collapse of the unit and subsequent personal injury. **Fastening hardware not included.** Mounting hardware used should be based on wall material. Consult an installation professional for proper wall mounting.

OVERHEAD STORAGE W/OPEN FRONTS - 33"

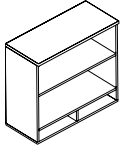

Open Front Overhead Storage w/Pigeon Hole - 32.5"/33"H

MODEL#	DIMENSIONS	FREIGHT CLASS	WT/LBS.	CUBIC FT.	1" TOP	1.5" TOP	GLAZE ADD	HP ADD
Z42S330PN	16 x 42 x 32.5-33	125	116	16.25	\$839	\$896	N/A	N/A
Z36S330PN	16 x 36 x 32.5-33	125	101	14	\$714	\$766	N/A	N/A
Z30S330PN	16 x 30 x 32.5-33	125	88	12	\$641	\$683	N/A	N/A
Z24S330PN	16 x 24 x 32.5-33	125	74	9.75	\$572	\$611	N/A	N/A

Includes steel hanging rail for wall mount applications. Includes one fixed shelf.

- **NOTE:** Care should be taken to mount the units. Units should be mounted to wall studs using correct fasteners. Failure to do so may result in collapse of the unit and subsequent personal injury. **Fastening hardware not included.** Mounting hardware used should be based on wall material. Consult an installation professional for proper wall mounting.

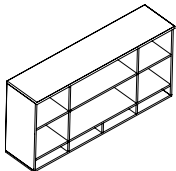

Open Front Overhead Storage w/Pigeon Hole - 32.5"/33"H

Z72S330N	16 x 72 x 32.5-33	125	194	26	\$1388	\$1458	N/A	N/A
Z66S330N	16 x 66 x 32.5-33	125	181	24	\$1304	\$1368	N/A	N/A
Z60S330N	16 x 60 x 32.5-33	125	169	22	\$1208	\$1268	N/A	N/A
Z54S330N	16 x 54 x 32.5-33	125	157	21	\$1133	\$1193	N/A	N/A

6 compartments. Includes steel hanging rail for wall mount applications. Includes one fixed shelf.

- **NOTE:** Care should be taken to mount the units. Units should be mounted to wall studs using correct fasteners. Failure to do so may result in collapse of the unit and subsequent personal injury. **Fastening hardware not included.** Mounting hardware used should be based on wall material. Consult an installation professional for proper wall mounting.

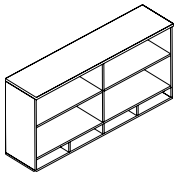

Open Front Overhead Storage w/Pigeon Hole - 32.5"/33"H

Z72S330SN	16 x 72 x 32.5-33	125	187	26	\$1308	\$1378	N/A	N/A
Z66S330SN	16 x 66 x 32.5-33	125	174	24	\$1241	\$1305	N/A	N/A
Z60S330SN	16 x 60 x 32.5-33	125	162	22	\$1159	\$1219	N/A	N/A
Z54S330SN	16 x 54 x 32.5-33	125	149	21	\$1083	\$1143	N/A	N/A

4 compartments. Includes steel hanging rail for wall mount applications. Includes one fixed shelf.

- **NOTE:** Care should be taken to mount the units. Units should be mounted to wall studs using correct fasteners. Failure to do so may result in collapse of the unit and subsequent personal injury. **Fastening hardware not included.** Mounting hardware used should be based on wall material. Consult an installation professional for proper wall mounting.

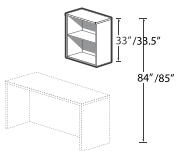

Open Front Overhead Storage 33"/33.5"H

Z42S330SN	16 x 42 x 32.5-33	125	108.98	16.25	\$579	\$635	N/A	N/A
Z36S330SN	16 x 36 x 32.5-33	125	96.70	14	\$526	\$575	N/A	N/A
Z30S330SN	16 x 30 x 32.5-33	125	84.42	11.75	\$471	\$501	N/A	N/A
Z24S330SN	16 x 24 x 32.5-33	125	67.20	9.75	\$434	\$468	N/A	N/A

Includes steel hanging rail for wall mount applications. Includes one fixed shelf.

- **NOTE:** Care should be taken to mount the units. Units should be mounted to wall studs using correct fasteners. Failure to do so may result in collapse of the unit and subsequent personal injury. **Fastening hardware not included.** Mounting hardware used should be based on wall material. Consult an installation professional for proper wall mounting.

Required Specifications

- Top finish
- Top/edge detail
- Base finish
- Lock finish*
- Handles

Optional Specifications

- Glazed doors
- Key #

OVERHEAD STORAGE W/OPEN FRONTS - 20"

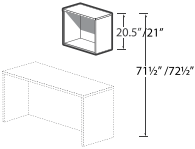

Open Front Overhead Storage
20"/20.5" High

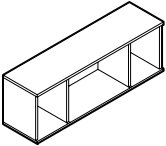

Open Front Overhead Storage
20/20.5"H

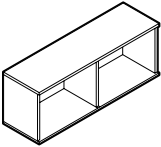

Open Front Overhead Storage
w/Center Divider - 20"/20.5"H

MODEL#	DIMENSIONS D x W x H	FREIGHT CLASS	WT/LBS.	CUBIC FT.	1" TOP	1.5" TOP	GLAZE ADD	HP ADD
Z42S200SN	16 x 42 x 20-20.5	125	77.98	10.50	\$404	\$460	N/A	N/A
Z36S200SN	16 x 36 x 20-20.5	125	69.70	9	\$366	\$415	N/A	N/A
Z30S200SN	16 x 30 x 20-20.5	100	60.42	7.50	\$329	\$359	N/A	N/A
Z24S200SN	16 x 24 x 20-20.5	125	48.13	6.25	\$297	\$331	N/A	N/A

Includes steel hanging rail for wall mount applications.

- **NOTE:** Care should be taken to mount the units. Units should be mounted to wall studs using correct fasteners. Failure to do so may result in collapse of the unit and subsequent personal injury. **Fastening hardware not included.** Mounting hardware used should be based on wall material. Consult an installation professional for proper wall mounting.

Z72S200N	16 x 72 x 20-20.5	125	122	18	\$814	\$890	N/A	N/A
Z66S200N	16 x 66 x 20-20.5	125	114	16.50	\$762	\$832	N/A	N/A
Z60S200N	16 x 60 x 20-20.5	125	106	15	\$710	\$774	N/A	N/A
Z54S200N	16 x 54 x 20-20.5	125	99	13.75	\$663	\$723	N/A	N/A

4 compartments. Includes steel hanging rail for wall mount applications.

- **NOTE:** Care should be taken to mount the units. Units should be mounted to wall studs using correct fasteners. Failure to do so may result in collapse of the unit and subsequent personal injury. **Fastening hardware not included.** Mounting hardware used should be based on wall material. Consult an installation professional for proper wall mounting.

Z72S200SN	16 x 72 x 20-20.5	125	117	18	\$786	\$862	N/A	N/A
Z66S200SN	16 x 66 x 20-20.5	125	109	16.50	\$732	\$802	N/A	N/A
Z60S200SN	16 x 60 x 20-20.5	125	101	15	\$680	\$744	N/A	N/A
Z54S200SN	16 x 54 x 20-20.5	125	94	13.75	\$633	\$693	N/A	N/A

Standard with pre-mounted "J" bracket for wall mount applications. Shipped RTA (ready to assemble).

- **NOTE:** Care should be taken to mount the units. Units should be mounted to wall studs using correct fasteners. Failure to do so may result in collapse of the unit and subsequent personal injury. **Fastening hardware not included.** Mounting hardware used should be based on wall material. Consult an installation professional for proper wall mounting.

OVERHEAD STORAGE W/OPEN FRONTS - 16" H

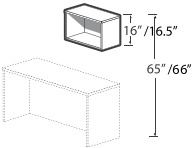

Open Front Overhead Storage
16"/16.5" H

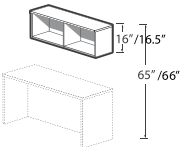

Open Front Overhead Storage
16"/16.5" High, 60" Wide

MODEL#	DIMENSIONS	FREIGHT CLASS	WT/LBS.	CUBIC FT.	1" TOP	1.5" TOP	GLAZE ADD	HP ADD
Z48S160SN	15 x 48 x 16-16.5	100	79.63	9.25	\$404	\$456	N/A	N/A
Z42S160SN	15 x 42 x 16-16.5	100	70.42	7.75	\$352	\$398	N/A	N/A
Z36S160SN	15 x 36 x 16-16.5	100	63.22	6.75	\$324	\$364	N/A	N/A
Z30S160SN	15 x 30 x 16-16.5	100	54.02	5.75	\$295	\$328	N/A	N/A

Standard with pre-mounted "J" bracket for wall mount applications. Shipped RTA (ready to assemble).

- **NOTE:** Care should be taken to mount the units. Units should be mounted to wall studs using correct fasteners. Failure to do so may result in collapse of the unit and subsequent personal injury. **Fastening hardware not included.** Mounting hardware used should be based on wall material. Consult an installation professional for proper wall mounting.

Z60S160SN	15 x 60 x 16-16.5	100	98.03	11	\$499	\$561	N/A	N/A
-----------	-------------------	-----	-------	----	-------	-------	-----	-----

Standard with pre-mounted "J" bracket for wall mount applications. Shipped RTA (ready to assemble).

- **NOTE:** Care should be taken to mount the units. Units should be mounted to wall studs using correct fasteners. Failure to do so may result in collapse of the unit and subsequent personal injury. **Fastening hardware not included.** Mounting hardware used should be based on wall material. Consult an installation professional for proper wall mounting.

Required Specifications

Top finish
Base finish
Top/Edge Detail

Accessories

Tackboard
Pigeon-Hole Storage

OPEN HUTCHES

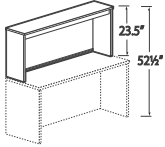

Open Hutch w/Closed Back - 23.5"H

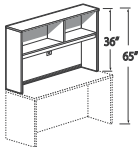

Open Hutch w/Closed Back - 36"H

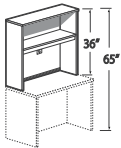

Open Hutch w/Closed Back - 36"H

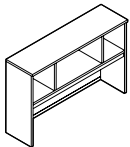

Open Hutch w/Closed Back - 36"H

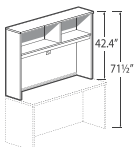

Open Hutch w/Closed Back - 42.4"H

MODEL#	DIMENSIONS D x W x H	FREIGHT CLASS	WT/LBS.	CUBIC FT.	1" TOP	1.5" TOP	GLAZE ADD	HP ADD
Z84S23HN	15 x 84 x 23-23.5	150	129	23	\$731	\$817	N/A	N/A
Z72S23HN	15 x 72 x 23-23.5	150	114	19.75	\$641	\$726	N/A	N/A
Z71S23HN	15 x 71.7 x 23-23.5	150	113	19.75	\$641	\$716	N/A	N/A
Z66S23HN	15 x 66 x 23-23.5	150	106	18.25	\$588	\$655	N/A	N/A
Z60S23HN	15 x 60 x 23-23.5	125	99	16.50	\$520	\$583	N/A	N/A
Z48S23HN	15 x 48 x 23-23.5	125	84	13.50	\$450	\$502	N/A	N/A
Z42S23HN	15 x 42 x 23-23.5	125	76	11.75	\$418	\$463	N/A	N/A
Z36S23HN	15 x 36 x 23-23.5	125	68	10.25	\$386	\$427	N/A	N/A
Z30S23HN	15 x 30 x 23-23.5	125	61	8.50	\$358	\$397	N/A	N/A

Closed back features one grommet and flexible sweep for wire management. All hutches shipped pre-assembled.

- Clearance from worksurface to valance is 20.25".
- Woodgrain runs horizontal on both the upper and lower back panels.

Z84S36HN	15 x 84 x 35.5-36	125	206	33	\$948	\$1034	N/A	N/A
Z72S36HN	15 x 72 x 35.5-36	125	181	28.25	\$869	\$944	N/A	N/A
Z71S36HN	15 x 71.7 x 35.5-36	125	173	28.25	\$861	\$937	N/A	N/A
Z66S36HN	15 x 66 x 35.5-36	125	161	26	\$813	\$883	N/A	N/A
Z60S36HN	15 x 60 x 35.5-36	125	150	23.75	\$761	\$823	N/A	N/A
Z54S36HN	15 x 54 x 35.5-36	125	128	21	\$761	\$823	N/A	N/A

One fixed shelf **and fixed shelf divider**. Closed back features one grommet and flexible sweep for wire management. All hutches shipped pre-assembled.

- Clearance from worksurface to valance is 17.75".
- Woodgrain runs horizontal on both the upper and lower back panels.

Z48S36HN	15 x 48 x 35.5-36	125	123	19	\$628	\$680	N/A	N/A
Z42S36HN	15 x 42 x 35.5-36	125	112	16.75	\$580	\$625	N/A	N/A
Z36S36HN	15 x 36 x 35.5-36	125	100	14.50	\$531	\$571	N/A	N/A
Z30S36HN	15 x 30 x 35.5-36	125	89	12.25	\$485	\$518	N/A	N/A

One fixed shelf. Closed back features one grommet and flexible sweep for wire management. All hutches shipped pre-assembled.

- Clearance from worksurface to valance is 17.75".
- Woodgrain runs horizontal on both the upper and lower back panels.

Z72S36OHN	15 x 72 x 35.5-36	150	162	27.75	\$1001	\$1080	N/A	N/A
Z66S36OHN	15 x 66 x 35.5-36	150	152	25.50	\$949	\$1022	N/A	N/A
Z60S36OHN	15 x 60 x 35.5-36	125	142	23.25	\$892	\$958	N/A	N/A
Z54S36OHN	15 x 54 x 35.5-36	125	133	21	\$836	\$896	N/A	N/A

Four compartments. Closed back features one grommet and flexible sweep for wire management. All hutches shipped pre-assembled.

- Clearance from worksurface to valance is 17.75".
- Woodgrain runs horizontal on both the upper and lower back panels.

Z84S42HN	15 x 84 x 41.9-42.4	150	223	38.50	\$1012	\$1098	N/A	N/A
Z72S42HN	15 x 72 x 41.9-42.4	150	196	33	\$936	\$1011	N/A	N/A
Z71S42HN	15 x 71.7 x 41.9-42.4	150	188	33	\$931	\$1006	N/A	N/A
Z66S42HN	15 x 66 x 41.9-42.4	150	175	30.75	\$875	\$942	N/A	N/A
Z60S42HN	15 x 60 x 41.9-42.4	150	164	27.75	\$819	\$881	N/A	N/A
Z54S42HN	15 x 54 x 41.9-42.4	150	140	24.50	\$819	\$881	N/A	N/A

One fixed shelf **and fixed shelf divider**. Closed back features one grommet and flexible sweep for wire management. All hutches shipped pre-assembled.

- Clearance from worksurface to valance is 24.25".
- Woodgrain runs horizontal on both the upper and lower back panels.

Required Specifications

- Top finish
- Base finish
- Top/Edge Detail

Accessories

- Tackboard
- Pigeon-Hole Storage

OPEN HUTCHES

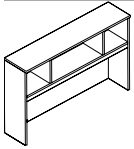

Open Hutch w/Closed Back - 42.4"H

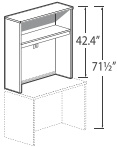

Open Hutch w/Closed Back - 42.4"H

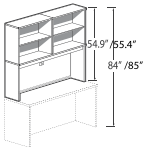

**Open Hutch w/Closed Back
54.9"/55.4"H**

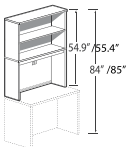

**Open Hutch w/Closed Back
54.9"/55.4"H**

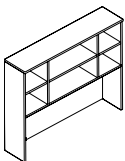

**Open Hutch w/Closed Back
54.9"/55.4"H**

MODEL#	DIMENSIONS D x W x H	FREIGHT CLASS	WT/LBS.	CUBIC FT.	1" TOP	1.5" TOP	GLAZE ADD	HP ADD
Z72S42OHN	15 x 72 x 41.9-42.4	150	177	32.50	\$1118	\$1190	N/A	N/A
Z66S42OHN	15 x 66 x 41.9-42.4	150	166	29.75	\$1024	\$1090	N/A	N/A
Z60S42OHN	15 x 60 x 41.9-42.4	150	155	27.25	\$963	\$1023	N/A	N/A
Z54S42OHN	15 x 54 x 41.9-42.4	150	145	24.50	\$903	\$956	N/A	N/A

Four compartments. Closed back features one grommet and flexible sweep for wire management. All hutches shipped pre-assembled.

- Clearance from worksurface to valance is 17.75".
- Woodgrain runs horizontal on both the upper and lower back panels.

Z48S42HN	15 x 48 x 41.9-42.4	125	134	22.25	\$680	\$732	N/A	N/A
Z42S42HN	15 x 42 x 41.9-42.4	125	123	19.50	\$628	\$674	N/A	N/A
Z36S42HN	15 x 36 x 41.9-42.4	125	110	17	\$575	\$615	N/A	N/A
Z30S42HN	15 x 30 x 41.9-42.4	125	105	14.25	\$521	\$555	N/A	N/A

One fixed shelf. Closed back features one grommet and flexible sweep for wire management. All hutches shipped pre-assembled.

- Clearance from worksurface to valance is 24.25".
- Woodgrain runs horizontal on both the upper and lower back panels.

Z84S55HN	15 x 84 x 54.4-54.9	150	306	62.37	\$1660	\$1749	N/A	N/A
Z72S55HN	15 x 72 x 54.4-54.9	150	272	53.65	\$1549	\$1627	N/A	N/A
Z71S55HN	15 x 71.7 x 54.4-54.9	150	271	53.65	\$1541	\$1620	N/A	N/A
Z66S55HN	15 x 66 x 54.4-54.9	150	254	49.40	\$1489	\$1566	N/A	N/A
Z60S55HN	15 x 60 x 54.4-54.9	150	238	45.15	\$1332	\$1397	N/A	N/A
Z54S55HN	15 x 54 x 54.4-54.9	100	190	19.75	\$1713	\$1778	N/A	N/A

One fixed shelf and one adjustable shelf (per compartment). Closed back features one grommet and flexible sweep for wire management. Shipped RTA (ready to assemble).

- Clearance from worksurface to valance is 24.25".
- Woodgrain runs horizontal on both the upper and lower back panels.

Z48S55HN	15 x 48 x 54.4-54.9	150	183	36	\$1003	\$1055	N/A	N/A
Z42S55HN	15 x 42 x 54.4-54.9	150	168	31.50	\$927	\$973	N/A	N/A
Z36S55HN	15 x 36 x 54.4-54.9	150	149	27.26	\$844	\$884	N/A	N/A
Z30S55HN	15 x 30 x 54.4-54.9	150	132	23	\$766	\$802	N/A	N/A

One fixed shelf and one adjustable shelf. Closed back features one grommet and flexible sweep for wire management. Shipped RTA (ready to assemble).

- Clearance from worksurface to valance is 24.25".
- Woodgrain runs horizontal on both the upper and lower back panels.

Z72S55OHN	15 x 72 x 54.4-54.9	100	242	26	\$1648	\$1724	N/A	N/A
Z66S55OHN	15 x 66 x 54.4-54.9	100	228	24	\$1552	\$1622	N/A	N/A
Z60S55OHN	15 x 60 x 54.4-54.9	100	214	22	\$1461	\$1524	N/A	N/A
Z54S55OHN	15 x 54 x 54.4-54.9	92.5	199	19.76	\$1371	\$1428	N/A	N/A

Four compartments. Closed back features one grommet and flexible sweep for wire management. All hutches shipped pre-assembled.

- Clearance from worksurface to valance is 17.75".
- Woodgrain runs horizontal on both the upper and lower back panels.

Required Specifications

Top finish
Base finish
Top/Edge Detail

Accessories

Tackboard
Pigeon-Hole Storage

CLOSED HUTCHES

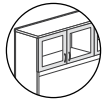
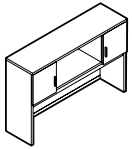

Glazed door option

Hutch w/2 Outer Doors - 36"H*

MODEL#	DIMENSIONS D x W x H	FREIGHT CLASS	WT/LBS.	CUBIC FT.	1"TOP	1.5" TOP	GLAZE ADD	HP ADD
Z72S36HOH	15 x 72 x 35.5-36	125	172	27.75	\$1174	\$1253	\$353	N/A
Z66S36HOH	15 x 66 x 35.5-36	125	161	25.50	\$1121	\$1194	\$344	N/A
Z60S36HOH	15 x 60 x 35.5-36	125	151	23.25	\$1050	\$1117	\$316	N/A
Z54S36HOH	15 x 54 x 35.5-36	125	140	21	\$992	\$1052	\$307	N/A

4 compartments. **Doors on outer compartments only.** Closed back features one grommet and flexible sweep for wire management. Doors lock. All hutches shipped pre-assembled.

- Clearance from worksurface to valance is 17.75".
- Woodgrain runs horizontal on both the upper and lower back panels.

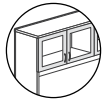
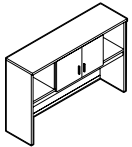

Glazed door option

Hutch w/2 Inner Doors - 36"H*

Z72S36OHO	15 x 72 x 35.5-36	125	173	27.75	\$1172	\$1256	\$357	N/A
Z66S36OHO	15 x 66 x 35.5-36	125	162	25.50	\$1123	\$1196	\$347	N/A
Z60S36OHO	15 x 60 x 35.5-36	125	151	23.25	\$1064	\$1130	\$334	N/A
Z54S36OHO	15 x 54 x 35.5-36	125	141	21	\$995	\$1055	\$311	N/A

4 compartments. **Doors on inner compartments only.** Closed back features one grommet and flexible sweep for wire management. Doors lock. All hutches shipped pre-assembled.

- Clearance from worksurface to valance is 17.75".
- Woodgrain runs horizontal on both the upper and lower back panels.

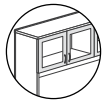
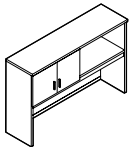

Glazed door option

Hutch w/2 Doors - LEFT, 36"H*

Z72S36HSL	15 x 72 x 35.5-36	125	169	27.75	\$1148	\$1226	\$352	N/A
Z66S36HSL	15 x 66 x 35.5-36	125	157	25.50	\$1094	\$1167	\$341	N/A
Z60S36HSL	15 x 60 x 35.5-36	125	146	23.25	\$1024	\$1091	\$317	N/A
Z54S36HSL	15 x 54 x 35.5-36	125	135	21	\$966	\$1027	\$308	N/A

4 compartments. Doors on **left** side, open storage on **right**. Closed back features one grommet and flexible sweep for wire management. Doors lock. All hutches shipped pre-assembled.

- Clearance from worksurface to valance is 17.75".
- Woodgrain runs horizontal on both the upper and lower back panels.

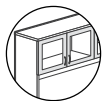
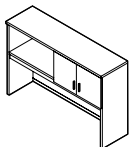

Glazed door option

Hutch w/2 Doors - RIGHT, 36"H*

Z72S36HSR	15 x 72 x 35.5-36	125	169	27.75	\$1148	\$1226	\$352	N/A
Z66S36HSR	15 x 66 x 35.5-36	125	157	25.50	\$1094	\$1167	\$341	N/A
Z60S36HSR	15 x 60 x 35.5-36	125	146	23.25	\$1024	\$1091	\$317	N/A
Z54S36HSR	15 x 54 x 35.5-36	125	135	21	\$966	\$1027	\$308	N/A

4 compartments. Doors on **right** side, open storage on **left**. Closed back features one grommet and flexible sweep for wire management. Doors lock. All hutches shipped pre-assembled.

- Clearance from worksurface to valance is 17.75".
- Woodgrain runs horizontal on both the upper and lower back panels.

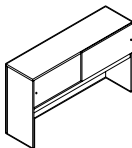

Hutch w/Sliding Glass Doors - 36"H

Z72S36HSD	15 x 72 x 35.5-36	125	178	27.75	\$2507	\$2586	N/A	N/A
Z66S36HSD	15 x 66 x 35.5-36	125	166	25.50	\$2340	\$2413	N/A	N/A
Z60S36HSD	15 x 60 x 35.5-36	125	154	23.25	\$2171	\$2238	N/A	N/A
Z54S36HSD	15 x 54 x 35.5-36	125	143	21	\$2008	\$2075	N/A	N/A

Sliding glass doors do not lock. Closed back features one grommet and flexible sweep for wire management. All hutches shipped pre-assembled.

- Clearance from worksurface to valance is 17.75".
- Woodgrain runs horizontal on both the upper and lower back panels.

Required Specifications

Top finish
Base finish
Top/Edge Detail
Handles - Doors

Optional Specifications

Glazing - Doors*

Accessories

Tackboard
Pigeon-Hole Storage

CLOSED HUTCHES

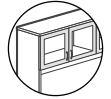
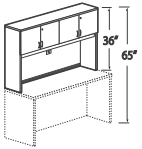

Glazed door option

Closed Hutch with Doors - 36" H

MODEL#	DIMENSIONS D x W x H	FREIGHT CLASS	WT./LBS.	CUBIC FT.	1" TOP	1.5" TOP	GLAZE ADD	HP ADD
Z84S36H	15 x 84 x 35.5-36	125	231	33	\$1301	\$1388	\$1042	N/A
Z72S36H	15 x 72 x 35.5-36	125	201	28.25	\$1212	\$1288	\$951	N/A
Z71S36H	15 x 71.7 x 35.5-36	125	193	28.25	\$1201	\$1277	\$949	N/A
Z66S36H	15 x 66 x 35.5-36	125	179	26	\$1142	\$1212	\$905	N/A
Z60S36H	15 x 60 x 35.5-36	125	167	23.75	\$1064	\$1126	\$851	N/A

One fixed shelf **and fixed shelf divider**. Closed back features one grommet and flexible sweep for wire management. Doors lock. All hutches shipped pre-assembled.

- Clearance from worksurface to valance is 17.75".
- Woodgrain runs horizontal on both the upper and lower back panels.

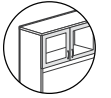
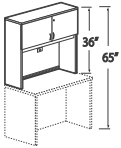

Glazed door option

Closed Hutch with Doors - 36" H

Z48S36H	15 x 48 x 35.5-36	125	136	19	\$834	\$886	\$540	N/A
Z42S36H	15 x 42 x 35.5-36	125	124	16.75	\$757	\$803	\$522	N/A
Z36S36H	15 x 36 x 35.5-36	125	110	14.50	\$692	\$732	\$477	N/A
Z30S36H	15 x 30 x 35.5-36	100	98	12.25	\$631	\$665	\$427	N/A

One fixed shelf. Closed back features one grommet and flexible sweep for wire management. Doors lock. All hutches shipped pre-assembled.

- Clearance from worksurface to valance is 17.75".
- Woodgrain runs horizontal on both the upper and lower back panels.

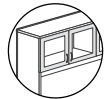
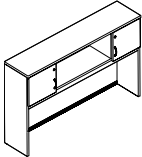

Glazed door option

Hutch w/2 Outer Doors - 42.4" H*

Z72S42HOH	15 x 72 x 41.9-42.4	150	187	32.50	\$1291	\$1363	\$353	N/A
Z66S42HOH	15 x 66 x 41.9-42.4	150	176	29.75	\$1195	\$1261	\$344	N/A
Z60S42HOH	15 x 60 x 41.9-42.4	125	164	27.25	\$1122	\$1182	\$316	N/A
Z54S42HOH	15 x 54 x 41.9-42.4	125	153	24.50	\$1060	\$1114	\$307	N/A

4 compartments. **Doors on outer compartments only**. Closed back features one grommet and flexible sweep for wire management. Doors lock. All hutches shipped pre-assembled.

- Clearance from worksurface to valance is 17.75".
- Woodgrain runs horizontal on both the upper and lower back panels.

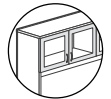
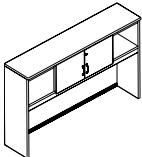

Glazed door option

Hutch w/2 Inner Doors - 42.4" H*

Z72S42HO	15 x 72 x 41.9-42.4	150	188	32.50	\$1293	\$1365	\$357	N/A
Z66S42HO	15 x 66 x 41.9-42.4	150	176	29.75	\$1197	\$1263	\$347	N/A
Z60S42HO	15 x 60 x 41.9-42.4	125	165	27.25	\$1135	\$1194	\$334	N/A
Z54S42HO	15 x 54 x 41.9-42.4	125	153	24.50	\$1062	\$1116	\$311	N/A

4 compartments. **Doors on inner compartments only**. Closed back features one grommet and flexible sweep for wire management. Doors lock. All hutches shipped pre-assembled.

- Clearance from worksurface to valance is 17.75".
- Woodgrain runs horizontal on both the upper and lower back panels.

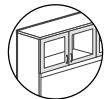
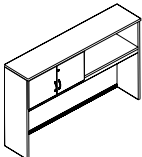

Glazed door option

Hutch w/2 Doors - LEFT, 42.4" H*

Z72S42HSL	15 x 72 x 41.9-42.4	150	184	32.50	\$1265	\$1337	\$352	N/A
Z66S42HSL	15 x 66 x 41.9-42.4	150	171	29.75	\$1167	\$1234	\$341	N/A
Z60S42HSL	15 x 60 x 41.9-42.4	150	159	27.25	\$1095	\$1154	\$317	N/A
Z54S42HSL	15 x 54 x 41.9-42.4	125	148	24.50	\$1033	\$1087	\$308	N/A

4 compartments. Doors on **left** side, open storage on **right**. Closed back features one grommet and flexible sweep for wire management. Doors lock. All hutches shipped pre-assembled.

- Clearance from worksurface to valance is 17.75".
- Woodgrain runs horizontal on both the upper and lower back panels.

Required Specifications

Top finish
Base finish
Top/Edge Detail
Handles - Doors

Optional Specifications

Glazing - Doors*

Accessories

Tackboard
Pigeon-Hole Storage

CLOSED HUTCHES

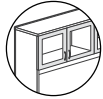
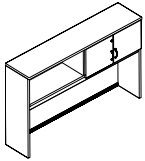

Glazed door option

Hutch w/2 Doors - RIGHT, 42.4" H*

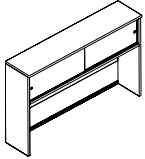

Hutch w/Sliding Glass Doors - 42.4" H

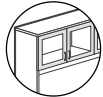
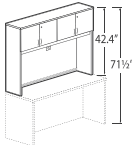

Glazed door option

Closed Hutch with Doors - 42.4" High

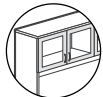
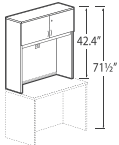

Glazed door option

Closed Hutch with Doors - 42.4" High

MODEL#	DIMENSIONS D x W x H	FREIGHT CLASS	WT/LBS.	CUBIC FT.	1" TOP	1.5" TOP	GLAZE ADD	HP ADD
Z72S42HSR	15 x 72 x 41.9-42.4	150	184	32.50	\$1265	\$1337	\$352	N/A
Z66S42HSR	15 x 66 x 41.9-42.4	150	171	29.75	\$1167	\$1234	\$341	N/A
Z60S42HSR	15 x 60 x 41.9-42.4	150	159	27.25	\$1095	\$1154	\$317	N/A
Z54S42HSR	15 x 54 x 41.9-42.4	125	148	24.50	\$1033	\$1087	\$308	N/A

4 compartments. Doors on **right** side, open storage on **left**. Closed back features one grommet and flexible sweep for wire management. Doors lock. All hutches shipped pre-assembled.

- Clearance from worksurface to valance is 17.75".
- Woodgrain runs horizontal on both the upper and lower back panels.

Z72S42HSD	15 x 72 x 41.9-42.4	150	193	32.50	\$2618	\$2690	N/A	N/A
Z66S42HSD	15 x 66 x 41.9-42.4	125	180	29.75	\$2413	\$2479	N/A	N/A
Z60S42HSD	15 x 60 x 41.9-42.4	125	168	27.25	\$2240	\$2300	N/A	N/A
Z54S42HSD	15 x 54 x 41.9-42.4	125	156	24.50	\$2075	\$2128	N/A	N/A

Sliding glass doors do not lock. Closed back features one grommet and flexible sweep for wire management. All hutches shipped pre-assembled.

- Clearance from worksurface to valance is 17.75".
- Woodgrain runs horizontal on both the upper and lower back panels.

Z84S42H	15 x 84 x 41.9-42.4	125	247	38.50	\$1446	\$1533	\$1042	N/A
Z72S42H	15 x 72 x 41.9-42.4	125	217	33	\$1282	\$1357	\$951	N/A
Z71S42H	15 x 71.7 x 41.9-42.4	125	207	33	\$1273	\$1348	\$949	N/A
Z66S42H	15 x 66 x 41.9-42.4	125	194	30.75	\$1203	\$1273	\$905	N/A
Z60S42H	15 x 60 x 41.9-42.4	125	180	27.75	\$1123	\$1185	\$851	N/A

One fixed shelf **and fixed shelf divider**. Closed back features one grommet and flexible sweep for wire management. Doors lock. All hutches shipped pre-assembled.

- Clearance from worksurface to valance is 24.25".
- Woodgrain runs horizontal on both the upper and lower back panels.

Z48S42H	15 x 48 x 41.9-42.4	125	148	22.25	\$887	\$939	\$540	N/A
Z42S42H	15 x 42 x 41.9-42.4	125	134	19.50	\$803	\$849	\$522	N/A
Z36S42H	15 x 36 x 41.9-42.4	125	120	17	\$734	\$775	\$477	N/A
Z30S42H	15 x 30 x 41.9-42.4	125	106	14.25	\$674	\$707	\$427	N/A

One fixed shelf. Closed back features one grommet and flexible sweep for wire management. Doors lock. All hutches shipped pre-assembled.

- Clearance from worksurface to valance is 24.25".
- Woodgrain runs horizontal on both the upper and lower back panels.

Required Specifications

Top finish
Base finish
Top/Edge Detail
Handles - Doors

Optional Specifications

Glazing - Doors*

Accessories

Tackboard
Pigeon-Hole Storage

CLOSED HUTCHES

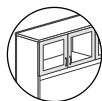
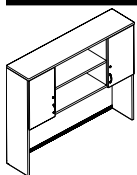

Glazed door option

Hutch w/2 Outer Doors - 55"H*

MODEL#	DIMENSIONS D x W x H	FREIGHT CLASS	WT./LBS.	CUBIC FT.	1" TOP	1.5" TOP	GLAZE ADD	HP ADD
Z72S55HOH	15 x 72 x 54.4-54.9	92.5	262	26	\$1881	\$1956	\$506	N/A
Z66S55HOH	15 x 66 x 54.4-54.9	92.5	246	24	\$1783	\$1853	\$496	N/A
Z60S55HOH	15 x 60 x 54.4-54.9	92.5	229	22	\$1667	\$1782	\$450	N/A
Z54S55HOH	15 x 54 x 54.4-54.9	92.5	213	19.76	\$1575	\$1683	\$441	N/A

4 compartments. **Doors on outer compartments only.** Closed back features one grommet and flexible sweep for wire management. Doors lock. All hutches shipped pre-assembled.

- Clearance from worksurface to valance is 17.75".
- Woodgrain runs horizontal on both the upper and lower back panels.

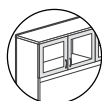
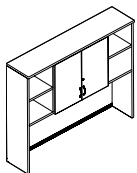

Glazed door option

Hutch w/2 Inner Doors - 55"H*

Z72S55OHO	15 x 72 x 54.4-54.9	92.5	263	26	\$1883	\$1959	\$508	N/A
Z66S55OHO	15 x 66 x 54.4-54.9	92.5	247	24	\$1786	\$1856	\$499	N/A
Z60S55OHO	15 x 60 x 54.4-54.9	92.5	230	22	\$1693	\$1756	\$453	N/A
Z54S55OHO	15 x 54 x 54.4-54.9	92.5	214	19.76	\$1577	\$1634	\$443	N/A

4 compartments. **Doors on inner compartments only.** Closed back features one grommet and flexible sweep for wire management. Doors lock. All hutches shipped pre-assembled.

- Clearance from worksurface to valance is 17.75".
- Woodgrain runs horizontal on both the upper and lower back panels.

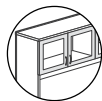
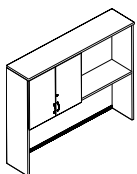

Glazed door option

Hutch w/2 Doors - LEFT, 55"H*

Z72S55HSL	15 x 72 x 54.4-54.9	100	258	26	\$1818	\$1894	\$488	N/A
Z66S55HSL	15 x 66 x 54.4-54.9	100	237	24	\$1735	\$1805	\$479	N/A
Z60S55HSL	15 x 60 x 54.4-54.9	92.5	221	22	\$1610	\$1674	\$450	N/A
Z54S55HSL	15 x 54 x 54.4-54.9	92.5	204	19.76	\$1527	\$1585	\$441	N/A

4 compartments. Doors on **left** side, open storage on **right**. Closed back features one grommet and flexible sweep for wire management. Doors lock. All hutches shipped pre-assembled.

- Clearance from worksurface to valance is 17.75".
- Woodgrain runs horizontal on both the upper and lower back panels.

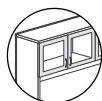
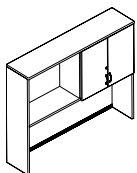

Glazed door option

Hutch w/2 Doors - RIGHT, 55"H*

Z72S55HSR	15 x 72 x 54.4-54.9	100	258	26	\$1818	\$1894	\$488	N/A
Z66S55HSR	15 x 66 x 54.4-54.9	100	237	24	\$1735	\$1805	\$479	N/A
Z60S55HSR	15 x 60 x 54.4-54.9	92.5	221	22	\$1610	\$1674	\$450	N/A
Z54S55HSR	15 x 54 x 54.4-54.9	92.5	204	19.76	\$1527	\$1585	\$441	N/A

4 compartments. Doors on **right** side, open storage on **left**. Closed back features one grommet and flexible sweep for wire management. Doors lock. All hutches shipped pre-assembled.

- Clearance from worksurface to valance is 17.75".
- Woodgrain runs horizontal on both the upper and lower back panels.

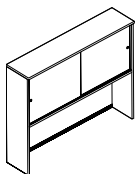

Hutch w/Sliding Glass Doors - 55"H

Z72S55HSD	15 x 72 x 54.4-54.9	92.5	271	26	\$3558	\$3633	N/A	N/A
Z66S55HSD	15 x 66 x 54.4-54.9	92.5	253	24	\$3327	\$3396	N/A	N/A
Z60S55HSD	15 x 60 x 54.4-54.9	92.5	235	22	\$3078	\$3141	N/A	N/A
Z54S55HSD	15 x 54 x 54.4-54.9	92.5	217	19.75	\$2851	\$2908	N/A	N/A

Sliding glass doors do not lock. Closed back features one grommet and flexible sweep for wire management. All hutches shipped pre-assembled.

- Clearance from worksurface to valance is 17.75".
- Woodgrain runs horizontal on both the upper and lower back panels.

Required Specifications

Top finish
Top/edge detail
Base finish
Lock finish

Optional Specifications

HP laminate Handles
Key # Modesty finish glazed
Modesty Type
Grommet position or power block cut-out

Accessories

Power block
Keyboard
Pencil drawer

CLOSED HUTCHES

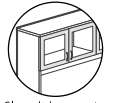
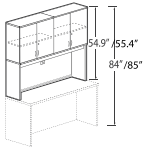

Glazed door option

Closed Hutch w/Doors - 55\"/>

MODEL#	DIMENSIONS D x W x H	FREIGHT CLASS	WT/LBS.	CUBIC FT.	1\"/>			
Z84S55H	15 x 84 x 54.4-54.9	150	349	62.37	\$2194	\$2283	\$1514	N/A
Z72S55H	15 x 72 x 54.4-54.9	150	308	53.65	\$1977	\$2065	\$1368	N/A
Z71S55H	15 x 71.7 x 54.4-54.9	150	307	53.65	\$1970	\$2049	\$1352	N/A
Z66S55H	15 x 66 x 54.4-54.9	150	287	49.40	\$1864	\$1942	\$1289	N/A
Z60S55H	15 x 60 x 54.4-54.9	150	269	45.15	\$1713	\$1778	\$1198	N/A

One fixed shelf and one adjustable shelf (per compartment). Closed back features one grommet and flexible sweep for wire management. Doors lock. Shipped RTA (ready to assemble).

- Clearance from worksurface to valance is 24.25\"/>

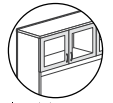
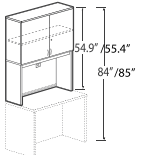

Glazed door option

Closed Hutch w/Doors - 55\"/>

Z48S55H	15 x 48 x 54.4-54.9	150	207	36	\$1274	\$1315	\$835	N/A
Z42S55H	15 x 42 x 54.4-54.9	150	188	31.50	\$1162	\$1208	\$758	N/A
Z36S55H	15 x 36 x 54.4-54.9	125	167	27.26	\$1058	\$1098	\$685	N/A
Z30S55H	15 x 30 x 54.4-54.9	125	148	23	\$957	\$990	\$600	N/A

One fixed shelf and one adjustable shelf. Closed back features one grommet and flexible sweep for wire management. Doors lock. Shipped RTA (ready to assemble).

- Clearance from worksurface to valance is 24.25\"/>

PIGEON-HOLE STORAGE

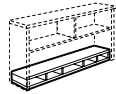
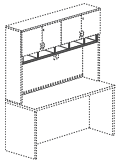

Horizontal Pigeon-Hole Storage

MODEL#	DIMENSIONS	FREIGHT CLASS	WT/LBS.	CUBIC FT.	1\"/>			
ZHS84	12 x 82 x 5.66	70	49	3	\$631	N/A	N/A	N/A
ZHS72	12 x 70 x 5.66	70	49	3	\$568	N/A	N/A	N/A
ZHS71	12 x 69.6 x 5.66	70	49	3	\$568	N/A	N/A	N/A
ZHS66	12 x 63.9 x 5.66	70	46	2.80	\$537	N/A	N/A	N/A
ZHS60	12 x 58 x 5.66	70	42	2.50	\$512	N/A	N/A	N/A
ZHS48	12 x 45.9 x 5.66	70	33	2	\$383	N/A	N/A	N/A
ZHS42	12 x 40 x 5.66	85	29	2	\$359	N/A	N/A	N/A
ZHS36	12 x 33.9 x 5.66	85	26	2	\$337	N/A	N/A	N/A

For additional storage. Can be **top** or **bottom** mounted. For use inside hutch. Shipped RTA (ready to assemble).

- *Cannot be used on overstorage units.*
- Available in all standard laminate finishes (page 118)

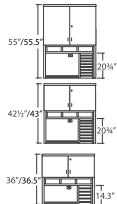
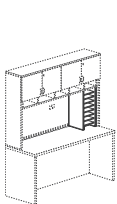

Vertical Pigeon-Hole Storage

ZVS21	11.8 x 13.42 x 20.75	70	30	1.80	\$283	N/A	N/A	N/A
ZVS14	11.8 x 13.42 x 14.3	85	24	1.80	\$229	N/A	N/A	N/A

For use in conjunction with the horizontal pigeon-hole storage. Can be used **under** or **over** horizontal unit. Not freestanding. Shipped RTA (ready to assemble).

- Vertical pigeon-hole shell - available in all standard laminate finishes (page 118).
- Collator shelves - available in Black (**K**) or Brushed Cobalt (**T**) finish. Please specify.
Use Brushed Cobalt to match Silver finish handles.

Required Specifications

Top finish
Top/edge detail
Base finish
Lock finish

Optional Specifications

HP laminate Handles
Key # Modesty finish glazed
Modesty Type
Grommet position or power block cut-out

Accessories

Power block
Keyboard
Pencil drawer

PIGEON-HOLE STORAGE

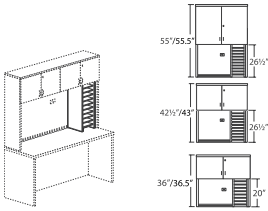

Vertical Pigeon-Hole Storage

MODEL#	DIMENSIONS D x W x H	FREIGHT CLASS	WT/LBS.	CUBIC FT.	1" TOP	1.5" TOP	GLAZE ADD	HP ADD
ZVS26	11.8 x 13.42 x 25.4-25.9	70	36	1.80	\$339	N/A	N/A	N/A
ZVS20	11.8 x 13.42 x 19-19.5	70	29	1.80	\$272	N/A	N/A	N/A

Used alone with a hutch. Not freestanding. Shipped RTA (ready to assemble).

- Vertical Pigeon-Hole Shell - Available in all standard laminate finishes (page 118).
- Collator Shelves - Available in Black (K) or Brushed Cobalt (T) finish. Please Specify.
Use Brushed Cobalt to match silver finish handles.

TRANSITIONAL PIGEON-HOLE STORAGE

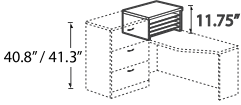

**Transitional Pigeon-Hole Storage
11.75\"/>**

MODEL#	DIMENSIONS	FREIGHT CLASS	WT/LBS.	CUBIC FT.	1" TOP	1.5" TOP	GLAZE ADD	HP ADD
Z24L12PH	24 x 24 x 11.25-11.75	65	63	2.70	\$560	\$616	N/A	N/A
Z20L12PH	24 x 20 x 11.25-11.75	70	56	2.70	\$494	\$542	N/A	N/A
Z16L12PH	24 x 16 x 11.25-11.75	65	46	1.60	\$453	\$494	N/A	N/A
Z24M12PH	20 x 24 x 11.25-11.75	70	55	2.70	\$494	\$542	N/A	N/A
Z20M12PH	20 x 20 x 11.25-11.75	70	48	2.70	\$438	\$477	N/A	N/A
Z16M12PH	20 x 16 x 11.25-11.75	65	40	1.60	\$398	\$431	N/A	N/A
Z24S12PH	16 x 24 x 11.25-11.75	65	43	1.60	\$455	\$495	N/A	N/A
Z20S12PH	16 x 20 x 11.25-11.75	65	38	1.60	\$400	\$432	N/A	N/A
Z16S12PH	16 x 16 x 11.25-11.75	70	33	1.60	\$374	\$402	N/A	N/A

Designed to fit on top of returns and transition worksurface to match 40.8"/41.3" high storage modules. Pigeon-hole shell and four collator shelves. Shipped RTA (ready to assemble).

- Pigeon-Hole Shell - Available in all standard laminate finishes (page 118).
- Collator Shelves - Available in Black (K) or Brushed Cobalt (T) finish. Please Specify.
Use Brushed Cobalt to match silver finish handles.

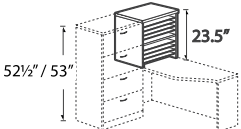

**Transitional Pigeon-Hole Storage
23.5\"/>**

Z24L23PH	24 x 24 x 23-23.5	60	101	2.70	\$1010	\$1066	N/A	N/A
Z20L23PH	24 x 20 x 23-23.5	60	88	2.70	\$883	\$929	N/A	N/A
Z16L23PH	24 x 16 x 23-23.5	65	76	2.70	\$829	\$870	N/A	N/A
Z24M23PH	20 x 24 x 23-23.5	60	87	2.70	\$886	\$932	N/A	N/A
Z20M23PH	20 x 20 x 23-23.5	65	76	2.70	\$775	\$814	N/A	N/A
Z16M23PH	20 x 16 x 23-23.5	60	64	1.60	\$711	\$744	N/A	N/A
Z24S23PH	16 x 24 x 23-23.5	65	74	2.70	\$837	\$877	N/A	N/A
Z20S23PH	16 x 20 x 23-23.5	65	65	2.70	\$731	\$764	N/A	N/A
Z16S23PH	16 x 16 x 23-23.5	60	54	1.60	\$669	\$698	N/A	N/A

Designed to fit on top of returns and transition worksurface to match 52.5"/53" high storage modules. Pigeon-hole shell and eight collator shelves. Shipped RTA (ready to assemble).

- Pigeon-Hole Shell - Available in all standard laminate finishes (page 118).
- Collator Shelves - Available in Black (K) or Brushed Cobalt (T) finish. Please Specify.
Use Brushed Cobalt to match silver finish handles.

Required Specifications

Finishes
Top/Edge Detail (Hutches)
Handles (Doors)

Optional Specifications

Glazing - Doors

Accessories

Tackboard (Hutches)
Pigeon-Hole Storage (Hutches)

FLOATING SHELVES

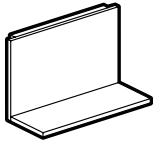

Floating Shelf - 20" H

MODEL#	DIMENSIONS	FREIGHT CLASS	WT/LBS.	CUBIC FT.	1" TOP	1.5" TOP	GLAZE ADD	HP ADD
D x W x H								
ZFS4220	16 x 42 x 20	70	55	2.75	\$457	\$485	N/A	N/A
ZFS3620	16 x 36 x 20	70	47	2.40	\$411	\$435	N/A	N/A
ZFS3020	16 x 30 x 20	70	39	2	\$349	\$369	N/A	N/A
ZFS2420	16 x 24 x 20	70	33	1.90	\$308	\$328	N/A	N/A

To match 71.9/72.4"H units. Standard with pre-mounted "J" bracket for wall mount applications. End cap required at the end of a run of floating shelves. End cap sold separately, see page 252.

- **NOTE:** Care should be taken to mount the units. Units should be mounted to wall studs using correct fasteners. Failure to do so may result in collapse of the unit and subsequent personal injury. **Fastening hardware not included.** Mounting hardware used should be based on wall material. Consult an installation professional for proper wall mounting.

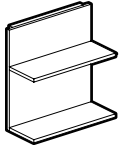

Double Floating Shelf - 32.5" H

ZF2S4232	16 x 42 x 32.5	65	85	3.30	\$654	\$682	N/A	N/A
ZF2S3632	16 x 36 x 32.5	65	73	2.90	\$585	\$609	N/A	N/A
ZF2S3032	16 x 30 x 32.5	65	60	2.50	\$498	\$518	N/A	N/A
ZF2S2432	16 x 24 x 32.5	70	50	2.40	\$441	\$461	N/A	N/A

To match 84.4/84.9"H units. Standard with pre-mounted "J" bracket for wall mount applications. End cap required at the end of a run of floating shelves. End cap sold separately, see page 252.

- **NOTE:** Care should be taken to mount the units. Units should be mounted to wall studs using correct fasteners. Failure to do so may result in collapse of the unit and subsequent personal injury. **Fastening hardware not included.** Mounting hardware used should be based on wall material. Consult an installation professional for proper wall mounting.

WALLS W/OVERHEADS

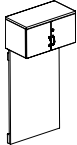

Wall w/Closed Storage - 66" H

MODEL#	DIMENSIONS	FREIGHT CLASS	WT/LBS.	CUBIC FT.	1" TOP	1.5" TOP	GLAZE ADD	HP ADD
Z4266WS	16 x 42 x 65.5-66	85	122	8.26	\$1101	\$1147	\$386	N/A
Z3666WS	16 x 36 x 65.5-66	85	113	8.80	\$927	\$967	\$355	N/A
Z3066WS	16 x 30 x 65.5-66	85	97	7.50	\$927	\$953	\$317	N/A
Z2466WS	16 x 24 x 65.5-66	92.5	79	6.60	\$818	\$846	\$286	N/A

Standard with pre-mounted "J" bracket for wall mount applications. Doors lock. End cap required at the end of a run of wall units. End cap sold separately, see page 252.

- **NOTE:** Care should be taken to mount the units. Units should be mounted to wall studs using correct fasteners. Failure to do so may result in collapse of the unit and subsequent personal injury. **Mounting hardware not included.** Mounting hardware used should be based on wall material. Consult an installation professional for proper wall mounting.

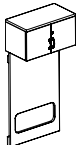

Wall w/Closed Storage - 66" H

Z4266WSO	16 x 42 x 65.5-66	125	112	18.60	\$1175	\$1221	\$386	N/A
Z3666WSO	16 x 36 x 65.5-66	125	100	16.20	\$1068	\$1108	\$355	N/A
Z3066WSO	16 x 30 x 65.5-66	125	85	13.50	\$931	\$968	\$317	N/A
Z2466WSO	16 x 24 x 65.5-66	92.5	70	6.20	\$825	\$853	\$286	N/A

Standard with pre-mounted "J" bracket for wall mount applications. Doors lock. Large cutout provides direct access to wall for access to electrical. End cap required at the end of a run of wall units. End cap sold separately, see page 252.

- **NOTE:** Care should be taken to mount the units. Units should be mounted to wall studs using correct fasteners. Failure to do so may result in collapse of the unit and subsequent personal injury. **Mounting hardware not included.** Mounting hardware used should be based on wall material. Consult an installation professional for proper wall mounting.

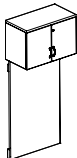

Wall w/Closed Storage - 72" H

Z4272WS	16 x 42 x 71.9-72.4	85	134	10.20	\$1175	\$1232	\$443	N/A
Z3672WS	16 x 36 x 71.9-72.4	85	119	9.46	\$1131	\$1182	\$404	N/A
Z3072WS	16 x 30 x 71.9-72.4	85	102	8.10	\$994	\$1036	\$362	N/A
Z2472WS	16 x 24 x 71.9-72.4	85	84	6.60	\$872	\$907	\$329	N/A

Standard with pre-mounted "J" bracket for wall mount applications. Doors lock. End cap required at the end of a run of wall units. End cap sold separately, see page 252.

- **NOTE:** Care should be taken to mount the units. Units should be mounted to wall studs using correct fasteners. Failure to do so may result in collapse of the unit and subsequent personal injury. **Mounting hardware not included.** Mounting hardware used should be based on wall material. Consult an installation professional for proper wall mounting.

Required Specifications

- Top finish
- Base finish
- Top/Edge Detail
- Handles

Optional Specifications

- Glazing - Doors
- Grommet position
- Key #
- End filler cap

WALLS W/OVERHEADS

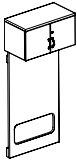

Wall w/Closed Storage - 72”H

MODEL#	DIMENSIONS D x W x H	FREIGHT CLASS	WT/LBS.	CUBIC FT.	1”TOP	1.5” TOP	GLAZE ADD	HP ADD
Z4272WSO	16 x 42 x 71.9-72.4	85	120	9.30	\$1186	\$1243	\$443	N/A
Z3672WSO	16 x 36 x 71.9-72.4	85	105	8.66	\$1141	\$1192	\$404	N/A
Z3072WSO	16 x 30 x 71.9-72.4	85	91	7.50	\$1002	\$1060	\$362	N/A
Z2472WSO	16 x 24 x 71.9-72.4	92.5	74	6.20	\$879	\$914	\$329	N/A

Standard with pre-mounted “J” bracket for wall mount applications. Doors lock. Large cutout provides direct access to wall for access to electrical. End cap required at the end of a run of wall units. End cap sold separately, see page 252.

• **NOTE:** Care should be taken to mount the units. Units should be mounted to wall studs using correct fasteners. Failure to do so may result in collapse of the unit and subsequent personal injury. **Mounting hardware not included.** Mounting hardware used should be based on wall material. Consult an installation professional for proper wall mounting.

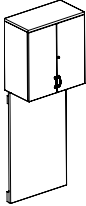

Wall w/Closed Storage - 84”H

Z4284WS	16 x 42 x 84.4-84.9	85	134	10.20	\$1452	\$1509	\$616	N/A
Z3684WS	16 x 36 x 84.4-84.9	85	119	9.46	\$1380	\$1440	\$561	N/A
Z3084WS	16 x 30 x 84.4-84.9	85	102	8.10	\$1213	\$1255	\$498	N/A
Z2484WS	16 x 24 x 84.4-84.9	85	84	6.60	\$1068	\$1103	\$453	N/A

Standard with pre-mounted “J” bracket for wall mount applications. Doors lock. End cap required at the end of a run of wall units. End cap sold separately, see page 252.

• **NOTE:** Care should be taken to mount the units. Units should be mounted to wall studs using correct fasteners. Failure to do so may result in collapse of the unit and subsequent personal injury. **Mounting hardware not included.** Mounting hardware used should be based on wall material. Consult an installation professional for proper wall mounting.

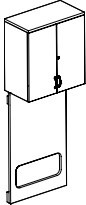

Wall w/Closed Storage - 84”H

Z4284WSO	16 x 42 x 84.4-84.9	85	120	9.30	\$1463	\$1520	\$616	N/A
Z3684WSO	16 x 36 x 84.4-84.9	85	105	8.66	\$1390	\$1450	\$561	N/A
Z3084WSO	16 x 30 x 84.4-84.9	85	91	7.50	\$1221	\$1263	\$498	N/A
Z2484WSO	16 x 24 x 84.4-84.9	92.5	74	6.20	\$1075	\$1110	\$453	N/A

Standard with pre-mounted “J” bracket for wall mount applications. Doors lock. Large cutout provides direct access to wall for access to electrical. End cap required at the end of a run of wall units. End cap sold separately, see page 252.

• **NOTE:** Care should be taken to mount the units. Units should be mounted to wall studs using correct fasteners. Failure to do so may result in collapse of the unit and subsequent personal injury. **Mounting hardware not included.** Mounting hardware used should be based on wall material. Consult an installation professional for proper wall mounting.

WALLS W/FLOATING SHELVES

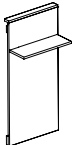

Wall w/Floating Shelf* - 66”H

MODEL#	DIMENSIONS	FREIGHT CLASS	WT/LBS.	CUBIC FT.	1”TOP	1.5” TOP	GLAZE ADD	HP ADD
ZF1S4266	16 x 42 x 65.5-66	70	117	7.50	\$857	\$885	N/A	N/A
ZF1S3666	16 x 36 x 65.5-66	70	103	6.60	\$746	\$770	N/A	N/A
ZF1S3066	16 x 30 x 65.5-66	70	86	5.70	\$644	\$668	N/A	N/A
ZF1S2466	16 x 24 x 65.5-66	85	69	4.70	\$551	\$570	N/A	N/A

Standard with pre-mounted “J” bracket for wall mount applications. End cap required at the end of a run of floating shelves. End cap sold separately, see page 252.

• **NOTE:** Care should be taken to mount the units. Units should be mounted to wall studs using correct fasteners. Failure to do so may result in collapse of the unit and subsequent personal injury. **Fastening hardware not included.** Mounting hardware used should be based on wall material. Consult an installation professional for proper wall mounting.

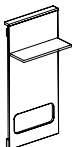

Wall w/Floating Shelf* - 66”H

ZF1S42660	16 x 42 x 65.5-66	85	110	7.50	\$866	\$894	N/A	N/A
ZF1S36660	16 x 36 x 65.5-66	85	97	6.60	\$755	\$779	N/A	N/A
ZF1S30660	16 x 30 x 65.5-66	85	81	5.70	\$649	\$673	N/A	N/A
ZF1S24660	16 x 24 x 65.5-66	85	66	4.70	\$556	\$575	N/A	N/A

Standard with pre-mounted “J” bracket for wall mount applications. Large cutout provides direct access to wall for access to electrical. End cap required at the end of a run of floating shelves. End cap sold separately, see page 252.

• **NOTE:** Care should be taken to mount the units. Units should be mounted to wall studs using correct fasteners. Failure to do so may result in collapse of the unit and subsequent personal injury. **Fastening hardware not included.** Mounting hardware used should be based on wall material. Consult an installation professional for proper wall mounting.

Required Specifications

Top finish
Base finish
Top/Edge Detail

Optional Specifications

End filler cap
Grommet*

WALLS W/FLOATING SHELVES

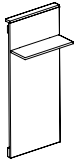

Wall w/Floating Shelf* - 72"H

MODEL#	DIMENSIONS D x W x H	FREIGHT CLASS	WT/LBS.	CUBIC FT.	1" TOP	1.5" TOP	GLAZE ADD	HP ADD
ZF1S4272	16 x 42 x 71.9-72.4	70	127	8	\$903	\$931	N/A	N/A
ZF1S3672	16 x 36 x 71.9-72.4	70	110	7.10	\$788	\$812	N/A	N/A
ZF1S3072	16 x 30 x 71.9-72.4	70	92	6.10	\$695	\$719	N/A	N/A
ZF1S2472	16 x 24 x 71.9-72.4	85	74	5	\$588	\$607	N/A	N/A

Standard with pre-mounted "J" bracket for wall mount applications. End cap required at the end of a run of floating shelves. End cap sold separately, see page 252.

- **NOTE:** Care should be taken to mount the units. Units should be mounted to wall studs using correct fasteners. Failure to do so may result in collapse of the unit and subsequent personal injury. **Fastening hardware not included.** Mounting hardware used should be based on wall material. Consult an installation professional for proper wall mounting.

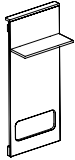

Wall w/Floating Shelf* - 72"H

ZF1S42720	16 x 42 x 71.9-72.4	70	120	8	\$913	\$941	N/A	N/A
ZF1S36720	16 x 36 x 71.9-72.4	85	104	7.10	\$797	\$821	N/A	N/A
ZF1S30720	16 x 30 x 71.9-72.4	85	87	6.10	\$704	\$728	N/A	N/A
ZF1S24720	16 x 24 x 71.9-72.4	85	71	5	\$593	\$612	N/A	N/A

Standard with pre-mounted "J" bracket for wall mount applications. Large cutout provides direct access to wall for access to electrical. End cap required at the end of a run of floating shelves. End cap sold separately, see page 252.

- **NOTE:** Care should be taken to mount the units. Units should be mounted to wall studs using correct fasteners. Failure to do so may result in collapse of the unit and subsequent personal injury. **Fastening hardware not included.** Mounting hardware used should be based on wall material. Consult an installation professional for proper wall mounting.

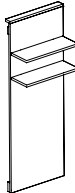

Wall w/Floating Shelves - 84"H

ZF2S4284	16 x 42 x 84.4-84.9	70	158	9.50	\$1061	\$1089	N/A	N/A
ZF2S3684	16 x 36 x 84.4-84.9	70	136	8.40	\$913	\$946	N/A	N/A
ZF2S3084	16 x 30 x 84.4-84.9	70	113	7.10	\$806	\$825	N/A	N/A
ZF2S2484	16 x 24 x 84.4-84.9	85	91	6.25	\$700	\$719	N/A	N/A

Standard with pre-mounted "J" bracket for wall mount applications. End cap required at the end of a run of floating shelves. End cap sold separately, see page 252.

- **NOTE:** Care should be taken to mount the units. Units should be mounted to wall studs using correct fasteners. Failure to do so may result in collapse of the unit and subsequent personal injury. **Fastening hardware not included.** Mounting hardware used should be based on wall material. Consult an installation professional for proper wall mounting.

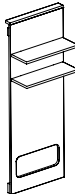

Wall w/Floating Shelves - 84"H

ZF2S42840	16 x 42 x 84.4-84.9	70	148	9.50	\$1070	\$1098	N/A	N/A
ZF2S36840	16 x 36 x 84.4-84.9	70	128	8.40	\$926	\$954	N/A	N/A
ZF2S30840	16 x 30 x 84.4-84.9	85	106	7.10	\$875	\$894	N/A	N/A
ZF2S24840	16 x 24 x 84.4-84.9	85	86	6.25	\$704	\$723	N/A	N/A

Standard with pre-mounted "J" bracket for wall mount applications. Large cutout provides direct access to wall for access to electrical. End cap required at the end of a run of floating shelves. End cap sold separately, see page 252.

- **NOTE:** Care should be taken to mount the units. Units should be mounted to wall studs using correct fasteners. Failure to do so may result in collapse of the unit and subsequent personal injury. **Fastening hardware not included.** Mounting hardware used should be based on wall material. Consult an installation professional for proper wall mounting.

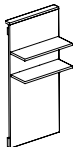

Wall w/Floating Shelves - 66"H

ZF2S4266	16 x 42 x 65.5-66	70	132	7.50	\$884	\$912	N/A	N/A
ZF2S3666	16 x 36 x 65.5-66	70	115	6.60	\$767	\$791	N/A	N/A
ZF2S3066	16 x 30 x 65.5-66	70	96	5.70	\$666	\$686	N/A	N/A
ZF2S2466	16 x 24 x 65.5-66	70	77	4.70	\$569	\$589	N/A	N/A

Standard with pre-mounted "J" bracket for wall mount applications. End cap required at the end of a run of floating shelves. End cap sold separately, see page 252.

- **NOTE:** Care should be taken to mount the units. Units should be mounted to wall studs using correct fasteners. Failure to do so may result in collapse of the unit and subsequent personal injury. **Fastening hardware not included.** Mounting hardware used should be based on wall material. Consult an installation professional for proper wall mounting.

Required Specifications

Top finish
Base finish
Top/Edge Detail

Optional Specifications

End filler cap
Grommet

WALLS W/FLOATING SHELVES

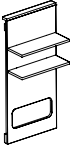

Wall w/Floating Shelves - 66"H

MODEL#	DIMENSIONS D x W x H	FREIGHT CLASS	WT/LBS.	CUBIC FT.	1" TOP	1.5" TOP	GLAZE ADD	HP ADD
ZF2S42660	16 x 42 x 65.5-66	70	125	7.50	\$895	\$923	N/A	N/A
ZF2S36660	16 x 36 x 65.5-66	70	109	6.60	\$776	\$800	N/A	N/A
ZF2S30660	16 x 30 x 65.5-66	70	91	5.70	\$674	\$694	N/A	N/A
ZF2S24660	16 x 24 x 65.5-66	70	74	4.70	\$575	\$595	N/A	N/A

Standard with pre-mounted "J" bracket for wall mount applications. Large cutout provides direct access to wall for access to electrical. End cap required at the end of a run of floating shelves. End cap sold separately, see page 252.

• **NOTE:** Care should be taken to mount the units. Units should be mounted to wall studs using correct fasteners. Failure to do so may result in collapse of the unit and subsequent personal injury. **Fastening hardware not included.** Mounting hardware used should be based on wall material. Consult an installation professional for proper wall mounting.

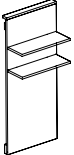

Wall w/Floating Shelves - 72"H

ZF2S4272	16 x 42 x 71.9-72.4	70	142	8	\$931	\$959	N/A	N/A
ZF2S3672	16 x 36 x 71.9-72.4	70	122	7.10	\$809	\$833	N/A	N/A
ZF2S3072	16 x 30 x 71.9-72.4	70	102	6.10	\$717	\$737	N/A	N/A
ZF2S2472	16 x 24 x 71.9-72.4	70	82	5	\$606	\$626	N/A	N/A

Standard with pre-mounted "J" bracket for wall mount applications. End cap required at the end of a run of floating shelves. End cap sold separately, see page 252.

• **NOTE:** Care should be taken to mount the units. Units should be mounted to wall studs using correct fasteners. Failure to do so may result in collapse of the unit and subsequent personal injury. **Fastening hardware not included.** Mounting hardware used should be based on wall material. Consult an installation professional for proper wall mounting.

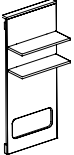

Wall w/Floating Shelves - 72"H

ZF2S42720	16 x 42 x 71.9-72.4	70	135	8	\$942	\$970	N/A	N/A
ZF2S36720	16 x 36 x 71.9-72.4	70	116	7.10	\$819	\$843	N/A	N/A
ZF2S30720	16 x 30 x 71.9-72.4	70	97	6.10	\$725	\$745	N/A	N/A
ZF2S24720	16 x 24 x 71.9-72.4	70	79	5	\$612	\$632	N/A	N/A

Standard with pre-mounted "J" bracket for wall mount applications. Large cutout provides direct access to wall for access to electrical. End cap required at the end of a run of floating shelves. End cap sold separately, see page 252.

• **NOTE:** Care should be taken to mount the units. Units should be mounted to wall studs using correct fasteners. Failure to do so may result in collapse of the unit and subsequent personal injury. **Fastening hardware not included.** Mounting hardware used should be based on wall material. Consult an installation professional for proper wall mounting.

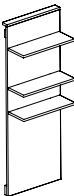

Wall w/Floating Shelves - 84"H

ZF3S4284	16 x 42 x 84.4-84.9	70	173	9.50	\$1088	\$1108	N/A	N/A
ZF3S3684	16 x 36 x 84.4-84.9	70	148	8.40	\$942	\$966	N/A	N/A
ZF3S3084	16 x 30 x 84.4-84.9	70	116	7.10	\$828	\$848	N/A	N/A
ZF3S2484	16 x 24 x 84.4-84.9	70	99	6.25	\$718	\$738	N/A	N/A

Standard with pre-mounted "J" bracket for wall mount applications. End cap required at the end of a run of floating shelves. End cap sold separately, see page 252.

• **NOTE:** Care should be taken to mount the units. Units should be mounted to wall studs using correct fasteners. Failure to do so may result in collapse of the unit and subsequent personal injury. **Fastening hardware not included.** Mounting hardware used should be based on wall material. Consult an installation professional for proper wall mounting.

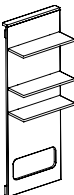

Wall w/Floating Shelves - 84"H

ZF3S42840	16 x 42 x 84.4-84.9	70	163	9.50	\$1099	\$1127	N/A	N/A
ZF3S36840	16 x 36 x 84.4-84.9	70	140	8.40	\$952	\$976	N/A	N/A
ZF3S30840	16 x 30 x 84.4-84.9	70	116	7.10	\$899	\$919	N/A	N/A
ZF3S24840	16 x 24 x 84.4-84.9	70	94	6.25	\$722	\$742	N/A	N/A

Standard with pre-mounted "J" bracket for wall mount applications. Large cutout provides direct access to wall for access to electrical. End cap required at the end of a run of floating shelves. End cap sold separately, see page 252.

• **NOTE:** Care should be taken to mount the units. Units should be mounted to wall studs using correct fasteners. Failure to do so may result in collapse of the unit and subsequent personal injury. **Fastening hardware not included.** Mounting hardware used should be based on wall material. Consult an installation professional for proper wall mounting.

Required Specifications

Top finish
Base finish
Top/edge detail

Optional Specifications

End filler cap
Grommet

WALL PANELS



Wall Panel - 66”H

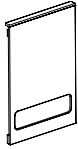

Wall Panel - 66”H



Wall Panel - 72”H



Wall Panel - 72”H



Wall Panel - 84”H

MODEL#	DIMENSIONS D x W x H	FREIGHT CLASS	WT/LBS.	CUBIC FT.	1” TOP	1.5” TOP	GLAZE ADD	HP ADD
ZWHP4266	-- x 42 x 65.5-66	85	99	7.50	\$760	\$788	N/A	N/A
ZWHP3666	-- x 36 x 65.5-66	85	90	6.60	\$603	\$627	N/A	N/A
ZWHP3066	-- x 30 x 65.5-66	85	75	5.70	\$523	\$543	N/A	N/A
ZWHP2466	-- x 24 x 65.5-66	85	61	4.70	\$447	\$467	N/A	N/A

Standard with pre-mounted “J” bracket for wall mount applications. End cap required at the end of a run of floating shelves. End cap sold separately, see page 252.

• **NOTE:** Care should be taken to mount the units. Units should be mounted to wall studs using correct fasteners. Failure to do so may result in collapse of the unit and subsequent personal injury. **Fastening hardware not included.** Mounting hardware used should be based on wall material. Consult an installation professional for proper wall mounting.

ZWHP42660	-- x 42 x 65.5-66	85	90	7.50	\$771	\$799	N/A	N/A
ZWHP36660	-- x 36 x 65.5-66	85	82	6.60	\$613	\$637	N/A	N/A
ZWHP30660	-- x 30 x 65.5-66	85	69	5.70	\$531	\$551	N/A	N/A
ZWHP24660	-- x 24 x 65.5-66	92.5	56	4.70	\$453	\$473	N/A	N/A

Standard with pre-mounted “J” bracket for wall mount applications. Large cutout provides direct access to wall for access to electrical. End cap required at the end of a run of floating shelves. End cap sold separately, see page 252.

• **NOTE:** Care should be taken to mount the units. Units should be mounted to wall studs using correct fasteners. Failure to do so may result in collapse of the unit and subsequent personal injury. **Fastening hardware not included.** Mounting hardware used should be based on wall material. Consult an installation professional for proper wall mounting.

ZWHP4272	-- x 42 x 71.9-72.4	85	113	8	\$742	\$770	N/A	N/A
ZWHP3672	-- x 36 x 71.9-72.4	85	97	7.10	\$646	\$670	N/A	N/A
ZWHP3072	-- x 30 x 71.9-72.4	85	81	6.10	\$574	\$594	N/A	N/A
ZWHP2472	-- x 24 x 71.9-72.4	85	67	5	\$484	\$504	N/A	N/A

Standard with pre-mounted “J” bracket for wall mount applications. End cap required at the end of a run of floating shelves. End cap sold separately, see page 252.

• **NOTE:** Care should be taken to mount the units. Units should be mounted to wall studs using correct fasteners. Failure to do so may result in collapse of the unit and subsequent personal injury. **Fastening hardware not included.** Mounting hardware used should be based on wall material. Consult an installation professional for proper wall mounting.

ZWHP42720	-- x 42 x 71.9-72.4	85	104	8	\$753	\$781	N/A	N/A
ZWHP36720	-- x 36 x 71.9-72.4	85	89	7.10	\$655	\$679	N/A	N/A
ZWHP30720	-- x 30 x 71.9-72.4	85	75	6.10	\$582	\$602	N/A	N/A
ZWHP24720	-- x 24 x 71.9-72.4	85	62	5	\$490	\$510	N/A	N/A

Standard with pre-mounted “J” bracket for wall mount applications. Large cutout provides direct access to wall for access to electrical. End cap required at the end of a run of floating shelves. End cap sold separately, see page 252.

• **NOTE:** Care should be taken to mount the units. Units should be mounted to wall studs using correct fasteners. Failure to do so may result in collapse of the unit and subsequent personal injury. **Fastening hardware not included.** Mounting hardware used should be based on wall material. Consult an installation professional for proper wall mounting.

ZWHP4284	-- x 42 x 84.4-84.9	85	128	9.50	\$791	\$819	N/A	N/A
ZWHP3684	-- x 36 x 84.4-84.9	85	111	8.40	\$697	\$721	N/A	N/A
ZWHP3084	-- x 30 x 84.4-84.9	85	92	7.10	\$620	\$640	N/A	N/A
ZWHP2484	-- x 24 x 84.4-84.9	85	75	6.25	\$535	\$555	N/A	N/A

Standard with pre-mounted “J” bracket for wall mount applications. End cap required at the end of a run of floating shelves. End cap sold separately, see page 252.

• **NOTE:** Care should be taken to mount the units. Units should be mounted to wall studs using correct fasteners. Failure to do so may result in collapse of the unit and subsequent personal injury. **Fastening hardware not included.** Mounting hardware used should be based on wall material. Consult an installation professional for proper wall mounting.

Required Specifications

Top finish
Base finish
Top/edge detail

Optional Specifications

End filler cap
Grommet

WALLS W/FLOATING SHELVES

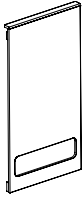

Wall Panel - 84”H

MODEL#	DIMENSIONS D x W x H	FREIGHT CLASS	WT/LBS.	CUBIC FT.	1”TOP	1.5” TOP	GLAZE ADD	HP ADD
ZWHP42840	-- x 42 x 84.4-84.9	85	119	9.50	\$802	\$830	N/A	N/A
ZWHP36840	-- x 36 x 84.4-84.9	85	103	8.40	\$706	\$730	N/A	N/A
ZWHP30840	-- x 30 x 84.4-84.9	85	92	7.10	\$628	\$648	N/A	N/A
ZWHP24840	-- x 24 x 84.4-84.9	92.5	70	6.25	\$541	\$561	N/A	N/A

Standard with pre-mounted “J” bracket for wall mount applications. Large cutout provides direct access to wall for access to electrical. End cap required at the end of a run of floating shelves. End cap sold separately, see page 252.

• **NOTE:** Care should be taken to mount the units. Units should be mounted to wall studs using correct fasteners. Failure to do so may result in collapse of the unit and subsequent personal injury. **Fastening hardware not included.** Mounting hardware used should be based on wall material. Consult an installation professional for proper wall mounting.

END FILLER CAPS



End Cap

MODEL#	DIMENSIONS	FREIGHT CLASS	WT/LBS.	CUBIC FT.	1”TOP	1.5” TOP	GLAZE ADD	HP ADD
ZEFC19	-- x -- x 17	70	1.50	.25	\$125	N/A	N/A	N/A

For ZFSxxxx 20”H floating shelf.



End Cap

ZEFC32	-- x -- x 30	300	2	2	\$204	N/A	N/A	N/A
--------	--------------	-----	---	---	--------------	-----	-----	-----

For ZF2Sxxxx 32.5”H floating shelf.



End Cap

ZEFC49	-- x -- x 47	250	3	1.20	\$269	N/A	N/A	N/A
--------	--------------	-----	---	------	--------------	-----	-----	-----

For Zxx66WS/Zxx66WSO 65.5/66”H walls with overhead.



End Cap

ZEFC52	-- x -- x 50	250	4	1.30	\$288	N/A	N/A	N/A
--------	--------------	-----	---	------	--------------	-----	-----	-----

For Zxx72WS/Zxx72WSO/Zxx84WS/Zxx84WSO 71.9/72.4”H or 84.4/84.9”H walls with overhead.



End Cap

ZEFC66	-- x -- x 64	300	4	4	\$352	N/A	N/A	N/A
--------	--------------	-----	---	---	--------------	-----	-----	-----

For ZF1Sxx66/ZF1Sxx66O/ZF2Sxx66/ZF2Sxx66O/ZWHPxx66/ZWHPxx66O 65.5/66”H wall panels, with or without shelves.

Required Specifications

Top finish
Base finish
Top/Edge Detail

Optional Specifications

End filler cap
Grommet

END FILLER CAPS

MODEL#	DIMENSIONS	FREIGHT CLASS	WT/LBS.	CUBIC FT.	1" TOP	1.5" TOP	GLAZE ADD	HP ADD
--------	------------	---------------	---------	-----------	--------	----------	-----------	--------

D x W x H

ZEFC72	-- x -- x 70.5	300	4	4	\$1	N/A	N/A	N/A
--------	----------------	-----	---	---	-----	-----	-----	-----



End Cap

For ZF1Sxx72/ZF1Sxx720/ZF2Sxx72/ZF2Sxx720/ZWHPxx72/ZWHPxx720 71.9/72.4"H wall panels, with or without shelves.



End Cap

ZEFC84	-- x -- x 83	300	5	4.50	\$445	N/A	N/A	N/A
--------	--------------	-----	---	------	-------	-----	-----	-----

For ZF1Sxx84/ZF1Sxx840/ZF2Sxx84/ZF2Sxx840/ZWHPxx84/ZWHPxx840 84.4/84.9"H wall panels, with or without shelves.

Required Specifications

Base finish

TACKBOARDS FOR HUTCHES - 23.5" / 24" HIGH

MODEL# DIMENSIONS FREIGHT CLASS WT/LBS. CUBIC FT. FABRIC GRADE LIST PRICE

D x W x H

TACKBOARD Notes: Tackboards can be upholstered in all of the following fabrics:

Grade 1: Agate II, Hudson, Jenny, Quilt, Terrace, Urban, Waterfall

Grade 2: Crescent, Imprint, Lola, Match, Renewal, Replay, Silhouette

Grade 3: Anchorage, Brinx, Mariposa, Merge

Grade 4: Accent

Grade 5: Meander, Tracery, Universe

TACKBOARDS FOR HUTCHES - 23.5" / 24" HIGH

MODEL# DIMENSIONS FREIGHT CLASS WT/LBS. CUBIC FT. FABRIC GRADE LIST PRICE

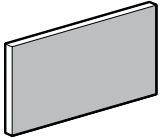

Tackboard

ZTB8217	.62 x 82 x 16.5-17	150	8.20	2	1	\$564
					2	\$676
					3	\$810
					4	\$969
					5	\$1114

For use on **Z84S23HN** hutch. Includes mounting screws.

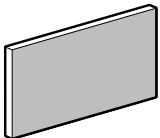

Tackboard

ZTB7017	.62 x 70 x 16.5-17	150	7	1.30	1	\$375
					2	\$451
					3	\$541
					4	\$644
					5	\$741

For use on **Z72S23HN** hutch. Includes mounting screws.

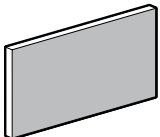

Tackboard

ZTB6917	.62 x 69 x 16.5-17	150	7	1.30	1	\$372
					2	\$446
					3	\$537
					4	\$639
					5	\$735

For use on **Z71S23HN** hutch. Includes mounting screws.

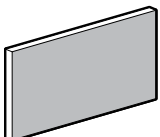

Tackboard

ZTB6417	.62 x 64 x 16.5-17	150	6.40	1.30	1	\$369
					2	\$442
					3	\$528
					4	\$630
					5	\$725

For use on **Z66S23HN** hutch. Includes mounting screws.

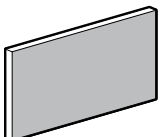

Tackboard

ZTB5817	.62 x 58 x 16.5-17	150	5.80	1.08	1	\$360
					2	\$431
					3	\$519
					4	\$616
					5	\$709

For use on **Z60S23HN** hutch. Includes mounting screws.

Required Specifications

Fabric

TACKBOARDS FOR HUTCHES - 23.5" / 24" HIGH

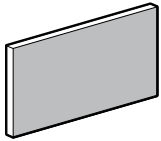

Tackboard

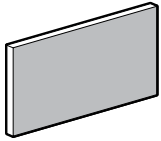

Tackboard

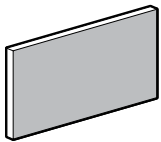

Tackboard

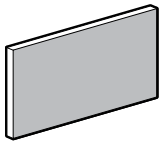

Tackboard

MODEL# DIMENSIONS FREIGHT CLASS WT/LBS. CUBIC FT. FABRIC GRADE LIST PRICE

D x W x H

ZTB4617	.62 x 46 x 16.5-17	150	4.60	.85	1	\$240
					2	\$288
					3	\$345
					4	\$409
					5	\$471

For use on **Z48S23HN** hutch. Includes mounting screws.

ZTB4017	.62 x 40 x 16.5-17	150	4	.85	1	\$232
					2	\$278
					3	\$333
					4	\$394
					5	\$453

For use on **Z42S23HN** hutch. Includes mounting screws.

ZTB3417	.62 x 34 x 16.5-17	150	3.40	.85	1	\$224
					2	\$268
					3	\$321
					4	\$379
					5	\$435

For use on **Z36S23HN** hutch. Includes mounting screws.

ZTB2817	.62 x 28 x 16.5-17	250	2.80	.85	1	\$215
					2	\$259
					3	\$309
					4	\$367
					5	\$423

For use on **Z30S23HN** hutch. Includes mounting screws.

TACKBOARDS FOR HUTCHES - 36" / 36.5" HIGH

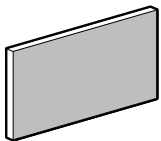

Tackboard

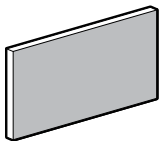

Tackboard

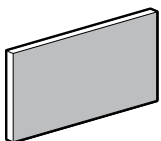

Tackboard

FABRIC GRADE LIST PRICE

ZTB8216	.62 x 82 x 15-15.5	150	8.20	2	1	\$564
					2	\$676
					3	\$810
					4	\$969
					5	\$1114

For use on **Z84S36H and Z84S36HN** hutches. Includes mounting screws.

ZTB7016	.62 x 70 x 15-15.5	150	7	1.30	1	\$375
					2	\$451
					3	\$541
					4	\$644
					5	\$741

For use on **Z72S36H and Z72S36HN** hutches. Includes mounting screws.

ZTB6916	.62 x 69.5 x 15-15.5	150	7	1.30	1	\$372
					2	\$446
					3	\$537
					4	\$639
					5	\$735

For use on **Z71S36H and Z71S36HN** hutches. Includes mounting screws.

Required Specifications

Fabric

TACKBOARDS FOR HUTCHES - 36" / 36.5" HIGH

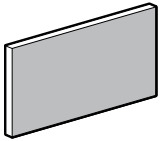

Tackboard

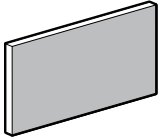

Tackboard

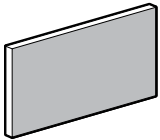

Tackboard

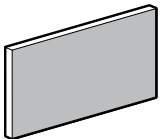

Tackboard

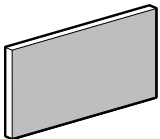

Tackboard

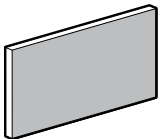

Tackboard

MODEL# DIMENSIONS FREIGHT CLASS WT/LBS. CUBIC FT. FABRIC GRADE LIST PRICE

	D x W x H					
ZTB6416	.62 x 64 x 15-15.5	150	6.40	1.30	1	\$369
					2	\$442
					3	\$528
					4	\$630
					5	\$725

For use on **Z66S36H and Z66S36HN** hutches. Includes mounting screws.

ZTB5816	.62 x 58 x 15-15.5	150	5.80	1.08	1	\$360
					2	\$431
					3	\$519
					4	\$616
					5	\$709

For use on **Z60S36H and Z60S36HN** hutches. Includes mounting screws.

ZTB4616	.62 x 46 x 15-15.5	150	4.60	.85	1	\$240
					2	\$288
					3	\$345
					4	\$409
					5	\$471

For use on **Z48S36H and Z48S36HN** hutches. Includes mounting screws.

ZTB4016	.62 x 40 x 15-15.5	150	4	.85	1	\$232
					2	\$278
					3	\$333
					4	\$394
					5	\$453

For use on **Z42S36H and Z42S36HN** hutch. Includes mounting screws.

ZTB3416	.62 x 34 x 15-15.5	150	3.40	.85	1	\$224
					2	\$268
					3	\$321
					4	\$379
					5	\$435

For use on **Z36S36H and Z36S36HN** hutch. Includes mounting screws.

ZTB2816	.62 x 28 x 15-15.5	250	2.80	.85	1	\$215
					2	\$259
					3	\$309
					4	\$367
					5	\$423

For use on **Z30S36H and Z30S36HN** hutch. Includes mounting screws.

Required Specifications

Fabric

TACKBOARDS FOR HUTCHES - 42.4", 42.9" AND 54.9", 55.4" HIGH

DIMENSIONS FREIGHT CLASS WT/LBS. CUBIC FT. FABRIC GRADE LIST PRICE

D x W x H

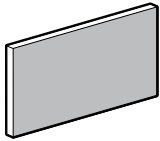

Tackboard

ZTB8221	.62 x 82 x 20.5-21	150	12.80	2.30	1	\$688
					2	\$823
					3	\$988
					4	\$1180
					5	\$1357

For use on **Z84S42H, Z84S42HN, Z84S55H and Z84S55HN** hutches. Includes mounting screws.

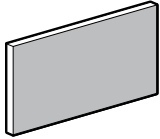

Tackboard

ZTB7021	.62 x 70 x 20.5-21	125	11	1.50	1	\$462
					2	\$551
					3	\$662
					4	\$788
					5	\$907

For use on **Z72S42H, Z72S42HN, Z72S55H and Z72S55HN** hutches. Includes mounting screws.

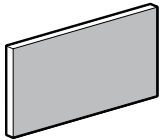

Tackboard

ZTB6921	.62 x 69 x 20.5-21	125	10.70	1.50	1	\$453
					2	\$544
					3	\$652
					4	\$778
					5	\$896

For use on **Z71S42H, Z71S42HN, Z71S55H and Z71S55HN** hutches. Includes mounting screws.

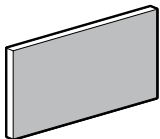

Tackboard

ZTB6421	.62 x 64 x 20.5-21	125	10	1.50	1	\$428
					2	\$514
					3	\$616
					4	\$735
					5	\$845

For use on **Z66S42H, Z66S42HN, Z66S55H and Z66S55HN** hutches. Includes mounting screws.

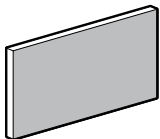

Tackboard

ZTB5821	.62 x 58 x 20.5-21	125	9	1.50	1	\$424
					2	\$511
					3	\$611
					4	\$727
					5	\$836

For use on **Z60S42H, Z60S42HN, Z60S55H and Z60S55HN** hutches. Includes mounting screws.

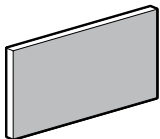

Tackboard

ZTB4621	.62 x 46 x 20.5-21	125	7.20	1	1	\$262
					2	\$316
					3	\$375
					4	\$446
					5	\$514

For use on **Z48S42H, Z48S42HN, Z48S55H and Z48S55HN** hutches. Includes mounting screws.

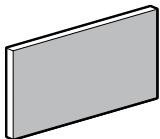

Tackboard

ZTB4021	.62 x 40 x 20.5-21	125	6.20	1	1	\$253
					2	\$303
					3	\$366
					4	\$433
					5	\$499

For use on **Z42S42H, Z42S42HN, Z42S55H and Z42S55HN** hutches. Includes mounting screws.

Required Specifications

Fabric

TACKBOARDS - 42.4", 42.9" & 54.9", 55.4" HIGH

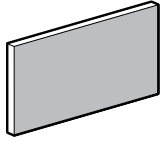

Tackboard

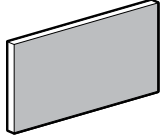

Tackboard

MODEL#	DIMENSIONS	FREIGHT CLASS	WT/LBS.	CUBIC FT.	FABRIC GRADE	LIST PRICE
ZTB3421	.62 x 34 x 20.5-21	150	5.30	1		
					D x W x H	
					1	\$250
					2	\$299
					3	\$359
4	\$425					
5	\$489					

For use on **Z36S42H, Z36S42HN, Z36S55H and Z36S55HN** hutches. Includes mounting screws.

ZTB2821	.62 x 28 x 20.5-21	150	4.50	1		
					1	\$247
					2	\$295
					3	\$353
					4	\$419
5	\$483					

For use on **Z30S42H, Z30S42HN, Z30S55H and Z30S55HN** hutches. Includes mounting screws.

Required Specifications

Fabric

14" WALL MOUNTED TACKBOARDS

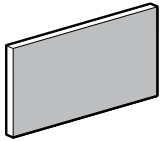

Wall Mounted Tackboard

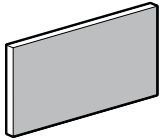

Wall Mounted Tackboard

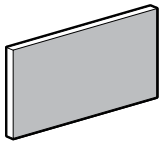

Wall Mounted Tackboard

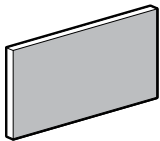

Wall Mounted Tackboard

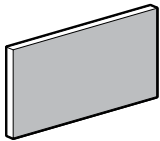

Wall Mounted Tackboard

MODEL# DIMENSIONS FREIGHT CLASS WT/LBS. CUBIC FT. FABRIC GRADE LIST PRICE

D x W x H

ZWHT3014	1.25 x 30 x 13.5-14	150	4.70	1	1	\$242
					2	\$278
					3	\$319
					4	\$367
					5	\$422

For use under **Z30S200S/OSN** for a finished height of **65"/65.5"**. Standard with pre-mounted "J" bracket for wall mount applications.

- **NOTE:** Care should be taken to mount the units. Units should be mounted to wall studs using correct fasteners. Failure to do so may result in collapse of the unit and subsequent personal injury. **Mounting hardware not included.** Mounting hardware used should be based on wall material. Consult an installation professional for proper wall mounting.

ZWHT3614	1.25 x 36 x 13.5-14	150	5.60	1	1	\$267
					2	\$307
					3	\$354
					4	\$406
					5	\$467

For use under **Z36S200S/OSN** for a finished height of **65"/65.5"**. Standard with pre-mounted "J" bracket for wall mount applications.

- **NOTE:** Care should be taken to mount the units. Units should be mounted to wall studs using correct fasteners. Failure to do so may result in collapse of the unit and subsequent personal injury. **Mounting hardware not included.** Mounting hardware used should be based on wall material. Consult an installation professional for proper wall mounting.

ZWHT4214	1.25 x 42 x 13.5-14	125	6.50	1	1	\$313
					2	\$358
					3	\$411
					4	\$472
					5	\$543

For use under **Z42S200S/OSN** for a finished height of **65"/65.5"**. Standard with pre-mounted "J" bracket for wall mount applications.

- **NOTE:** Care should be taken to mount the units. Units should be mounted to wall studs using correct fasteners. Failure to do so may result in collapse of the unit and subsequent personal injury. **Mounting hardware not included.** Mounting hardware used should be based on wall material. Consult an installation professional for proper wall mounting.

ZWHT4814	1.25 x 48 x 13.5-14	125	7.50	1	1	\$338
					2	\$389
					3	\$446
					4	\$513
					5	\$590

For use under **Z48S200S/OSN** for a finished height of **65"/65.5"**. Standard with pre-mounted "J" bracket for wall mount applications.

- **NOTE:** Care should be taken to mount the units. Units should be mounted to wall studs using correct fasteners. Failure to do so may result in collapse of the unit and subsequent personal injury. **Mounting hardware not included.** Mounting hardware used should be based on wall material. Consult an installation professional for proper wall mounting.

ZWHT6014	1.25 x 60 x 13.5-14	150	9.30	1.80	1	\$422
					2	\$484
					3	\$557
					4	\$640
					5	\$735

For use under **Z60S200S/OSN** for a finished height of **65"/65.5"**. Standard with pre-mounted "J" bracket for wall mount applications.

- **NOTE:** Care should be taken to mount the units. Units should be mounted to wall studs using correct fasteners. Failure to do so may result in collapse of the unit and subsequent personal injury. **Mounting hardware not included.** Mounting hardware used should be based on wall material. Consult an installation professional for proper wall mounting.

Required Specifications

Fabric

14" WALL MOUNTED TACKBOARDS

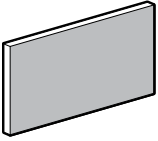

Wall Mounted Tackboard

MODEL#	DIMENSIONS D x W x H	FREIGHT CLASS	WT./LBS.	CUBIC FT.	FABRIC GRADE	LIST PRICE
ZWHT6614	1.25 x 66 x 13.5-14	150	10.30	1.80	1	\$448
					2	\$514
					3	\$591
					4	\$679
					5	\$780

For use under **ZxxS200S/OSN** for a finished height of **65"/65.5"**. Standard with pre-mounted "J" bracket for wall mount applications.

• **NOTE:** Care should be taken to mount the units. Units should be mounted to wall studs using correct fasteners. Failure to do so may result in collapse of the unit and subsequent personal injury. **Mounting hardware not included.** Mounting hardware used should be based on wall material. Consult an installation professional for proper wall mounting.

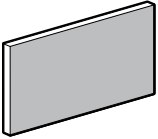

Wall Mounted Tackboard

ZWHT7214	1.25 x 72 x 13.5-14	125	11.20	1.80	1	\$491
					2	\$564
					3	\$649
					4	\$746
					5	\$858

For use under **ZxxS200S/OSN** for a finished height of **65"/65.5"**. Standard with pre-mounted "J" bracket for wall mount applications.

• **NOTE:** Care should be taken to mount the units. Units should be mounted to wall studs using correct fasteners. Failure to do so may result in collapse of the unit and subsequent personal injury. **Mounting hardware not included.** Mounting hardware used should be based on wall material. Consult an installation professional for proper wall mounting.

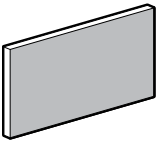

Wall Mounted Tackboard

ZWHT7814	1.25 x 78 x 13.5-14	125	12.10	1.80	1	\$518
					2	\$595
					3	\$684
					4	\$786
					5	\$904

For use under **ZxxS200S/OSN** for a finished height of **65"/65.5"**. Standard with pre-mounted "J" bracket for wall mount applications.

• **NOTE:** Care should be taken to mount the units. Units should be mounted to wall studs using correct fasteners. Failure to do so may result in collapse of the unit and subsequent personal injury. **Mounting hardware not included.** Mounting hardware used should be based on wall material. Consult an installation professional for proper wall mounting.

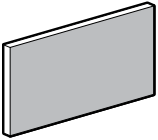

Wall Mounted Tackboard

ZWHT8414	1.25 x 84 x 13.5-14	125	13.10	1.80	1	\$561
					2	\$646
					3	\$742
					4	\$853
					5	\$980

For use under **ZxxS200S/OSN** for a finished height of **65"/65.5"**. Standard with pre-mounted "J" bracket for wall mount applications.

• **NOTE:** Care should be taken to mount the units. Units should be mounted to wall studs using correct fasteners. Failure to do so may result in collapse of the unit and subsequent personal injury. **Mounting hardware not included.** Mounting hardware used should be based on wall material. Consult an installation professional for proper wall mounting.

18" WALL MOUNTED TACKBOARDS

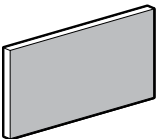

Wall Mounted Tackboard

MODEL#	DIMENSIONS	FREIGHT CLASS	WT./LBS.	CUBIC FT.	FABRIC GRADE	LIST PRICE
ZWHT3018	1.25 x 30 x 17.5-18	125	6	1	1	\$250
					2	\$287
					3	\$331
					4	\$380
					5	\$436

For use under **Z30S160S/OSN** for a finished height of **65"/65.5"**. Standard with pre-mounted "J" bracket for wall mount applications.

• **NOTE:** Care should be taken to mount the units. Units should be mounted to wall studs using correct fasteners. Failure to do so may result in collapse of the unit and subsequent personal injury. **Mounting hardware not included.** Mounting hardware used should be based on wall material. Consult an installation professional for proper wall mounting.

Required Specifications

Fabric

18" WALL MOUNTED TACKBOARDS

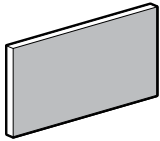

Wall Mounted Tackboard

MODEL# DIMENSIONS FREIGHT CLASS WT/LBS. CUBIC FT. FABRIC GRADE LIST PRICE

	D x W x H					
ZWHT3618	1.25 x 36 x 17.5-18	125	7.20	1	1	\$277
					2	\$318
					3	\$366
					4	\$421
					5	\$483

For use under **Z36S160S/OSN** for a finished height of **65"/65.5"**. Standard with pre-mounted "J" bracket for wall mount applications.

• **NOTE:** Care should be taken to mount the units. Units should be mounted to wall studs using correct fasteners. Failure to do so may result in collapse of the unit and subsequent personal injury. **Mounting hardware not included.** Mounting hardware used should be based on wall material. Consult an installation professional for proper wall mounting.

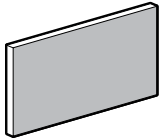

Wall Mounted Tackboard

ZWHT4218	1.25 x 42 x 17.5-18	100	8.40	1	1	\$322
					2	\$370
					3	\$425
					4	\$488
					5	\$561

For use under **Z42S160S/OSN** for a finished height of **65"/65.5"**. Standard with pre-mounted "J" bracket for wall mount applications.

• **NOTE:** Care should be taken to mount the units. Units should be mounted to wall studs using correct fasteners. Failure to do so may result in collapse of the unit and subsequent personal injury. **Mounting hardware not included.** Mounting hardware used should be based on wall material. Consult an installation professional for proper wall mounting.

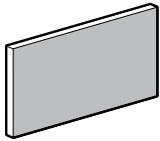

Wall Mounted Tackboard

ZWHT4818	1.25 x 48 x 17.5-18	100	9.60	1	1	\$350
					2	\$402
					3	\$462
					4	\$531
					5	\$610

For use under **Z48S160S/OSN** for a finished height of **65"/65.5"**. Standard with pre-mounted "J" bracket for wall mount applications.

• **NOTE:** Care should be taken to mount the units. Units should be mounted to wall studs using correct fasteners. Failure to do so may result in collapse of the unit and subsequent personal injury. **Mounting hardware not included.** Mounting hardware used should be based on wall material. Consult an installation professional for proper wall mounting.

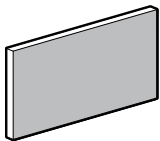

Wall Mounted Tackboard

ZWHT6018	1.25 x 60 x 17.5-18	125	12	1.80	1	\$432
					2	\$497
					3	\$571
					4	\$656
					5	\$754

For use under **Z60S160S/OSN** for a finished height of **65"/65.5"**. Standard with pre-mounted "J" bracket for wall mount applications.

• **NOTE:** Care should be taken to mount the units. Units should be mounted to wall studs using correct fasteners. Failure to do so may result in collapse of the unit and subsequent personal injury. **Mounting hardware not included.** Mounting hardware used should be based on wall material. Consult an installation professional for proper wall mounting.

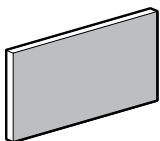

Wall Mounted Tackboard

ZWHT6618	1.25 x 66 x 17.5-18	125	13.20	1.80	1	\$460
					2	\$528
					3	\$608
					4	\$699
					5	\$804

For use under **ZxxS160S/OSN** for a finished height of **65"/65.5"**. Standard with pre-mounted "J" bracket for wall mount applications.

• **NOTE:** Care should be taken to mount the units. Units should be mounted to wall studs using correct fasteners. Failure to do so may result in collapse of the unit and subsequent personal injury. **Mounting hardware not included.** Mounting hardware used should be based on wall material. Consult an installation professional for proper wall mounting.

Required Specifications

Fabric

18" WALL MOUNTED TACKBOARDS

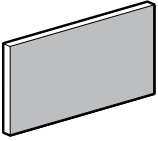

Wall Mounted Tackboard

MODEL#	DIMENSIONS	FREIGHT CLASS	WT/LBS.	CUBIC FT.	FABRIC GRADE	LIST PRICE	
ZWHT7218	1.25 x 72 x 17.5-18	100	14.40	1.80	D x W x H	1	\$505
					2	\$580	
					3	\$667	
					4	\$768	
					5	\$882	

For use under **ZxxS160S/OSN** for a finished height of **65"/65.5"**. Standard with pre-mounted "J" bracket for wall mount applications.

• **NOTE:** Care should be taken to mount the units. Units should be mounted to wall studs using correct fasteners. Failure to do so may result in collapse of the unit and subsequent personal injury. **Mounting hardware not included.** Mounting hardware used should be based on wall material. Consult an installation professional for proper wall mounting.

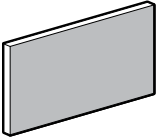

Wall Mounted Tackboard

ZWHT7818	1.25 x 78 x 17.5-18	100	15.60	1.80	1	\$532
					2	\$611
					3	\$702
					4	\$808
					5	\$927

For use under **ZxxS160S/OSN** for a finished height of **65"/65.5"**. Standard with pre-mounted "J" bracket for wall mount applications.

• **NOTE:** Care should be taken to mount the units. Units should be mounted to wall studs using correct fasteners. Failure to do so may result in collapse of the unit and subsequent personal injury. **Mounting hardware not included.** Mounting hardware used should be based on wall material. Consult an installation professional for proper wall mounting.

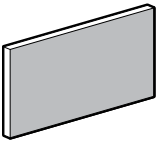

Wall Mounted Tackboard

ZWHT8418	1.25 x 84 x 17.5-18	100	16.80	1.80	1	\$576
					2	\$663
					3	\$762
					4	\$877
					5	\$1008

For use under **ZxxS160S/OSN** for a finished height of **65"/65.5"**. Standard with pre-mounted "J" bracket for wall mount applications.

• **NOTE:** Care should be taken to mount the units. Units should be mounted to wall studs using correct fasteners. Failure to do so may result in collapse of the unit and subsequent personal injury. **Mounting hardware not included.** Mounting hardware used should be based on wall material. Consult an installation professional for proper wall mounting.

21" WALL MOUNTED TACKBOARDS

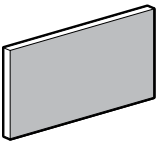

Wall Mounted Tackboard

MODEL#	DIMENSIONS	FREIGHT CLASS	WT/LBS.	CUBIC FT.	FABRIC GRADE	LIST PRICE
ZWHT3021	1.25 x 30 x 20.5-21	125	7	1	1	\$255
					2	\$294
					3	\$337
					4	\$388
					5	\$445

For use under **Z30S210S/OSN** or **Z30S330S/OSN** for a finished height of **71.5"/72"**. Standard with pre-mounted "J" bracket for wall mount applications. For use under **Z30S330S/OSN** for a finished height of **84"/84.5"**

• **NOTE:** Care should be taken to mount the units. Units should be mounted to wall studs using correct fasteners. Failure to do so may result in collapse of the unit and subsequent personal injury. **Mounting hardware not included.** Mounting hardware used should be based on wall material. Consult an installation professional for proper wall mounting.

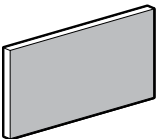

Wall Mounted Tackboard

ZWHT3621	1.25 x 36 x 20.5-21	100	8.40	1	1	\$283
					2	\$325
					3	\$373
					4	\$429
					5	\$494

For use under **Z36S210S/OSN** or **Z36S330S/OSN** for a finished height of **71.5"/72"**. Standard with pre-mounted "J" bracket for wall mount applications. For use under **Z30S330S/OSN** for a finished height of **84"/84.5"**

• **NOTE:** Care should be taken to mount the units. Units should be mounted to wall studs using correct fasteners. Failure to do so may result in collapse of the unit and subsequent personal injury. **Mounting hardware not included.** Mounting hardware used should be based on wall material. Consult an installation professional for proper wall mounting.

Required Specifications

Fabric

21" WALL MOUNTED TACKBOARDS

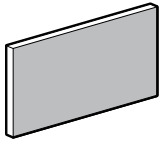

Wall Mounted Tackboard

MODEL# DIMENSIONS FREIGHT CLASS WT/LBS. CUBIC FT. FABRIC GRADE LIST PRICE

	D x W x H					
ZWHT4221	1.25 x 42 x 20.5-21	100	9.80	1	1	\$327
					2	\$376
					3	\$433
					4	\$498
					5	\$572

For use under **Z42S210S/OSN** or **Z42S330S/OSN** for a finished height of **71.5"/72"**. Standard with pre-mounted "J" bracket for wall mount applications. For use under **Z30S330S/OSN** for a finished height of **84"/84.5"**

• **NOTE:** Care should be taken to mount the units. Units should be mounted to wall studs using correct fasteners. Failure to do so may result in collapse of the unit and subsequent personal injury. **Mounting hardware not included.** Mounting hardware used should be based on wall material. Consult an installation professional for proper wall mounting.

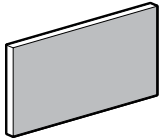

Wall Mounted Tackboard

ZWHT4821	1.25 x 48 x 20.5-21	92.5	11.20	1	1	\$356
					2	\$409
					3	\$469
					4	\$540
					5	\$622

For use under **Z48S210S/OSN** or **Z48S330S/OSN** for a finished height of **71.5"/72"**. Standard with pre-mounted "J" bracket for wall mount applications. For use under **Z30S330S/OSN** for a finished height of **84"/84.5"**

• **NOTE:** Care should be taken to mount the units. Units should be mounted to wall studs using correct fasteners. Failure to do so may result in collapse of the unit and subsequent personal injury. **Mounting hardware not included.** Mounting hardware used should be based on wall material. Consult an installation professional for proper wall mounting.

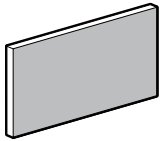

Wall Mounted Tackboard

ZWHT6021	1.25 x 60 x 20.5-21	125	14	1.80	1	\$441
					2	\$506
					3	\$582
					4	\$670
					5	\$770

For use under **Z60S210S/OSN** or **Z60S330S/OSN** for a finished height of **71.5"/72"**. Standard with pre-mounted "J" bracket for wall mount applications. For use under **Z30S330S/OSN** for a finished height of **84"/84.5"**

• **NOTE:** Care should be taken to mount the units. Units should be mounted to wall studs using correct fasteners. Failure to do so may result in collapse of the unit and subsequent personal injury. **Mounting hardware not included.** Mounting hardware used should be based on wall material. Consult an installation professional for proper wall mounting.

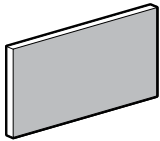

Wall Mounted Tackboard

ZWHT6621	1.25 x 66 x 20.5-21	100	15.40	1.80	1	\$468
					2	\$539
					3	\$618
					4	\$712
					5	\$818

For use under **ZxxS210S/OSN** or **ZxxS330S/OSN** for a finished height of **71.5"/72"**. Standard with pre-mounted "J" bracket for wall mount applications. For use under **Z30S330S/OSN** for a finished height of **84"/84.5"**

• **NOTE:** Care should be taken to mount the units. Units should be mounted to wall studs using correct fasteners. Failure to do so may result in collapse of the unit and subsequent personal injury. **Mounting hardware not included.** Mounting hardware used should be based on wall material. Consult an installation professional for proper wall mounting.

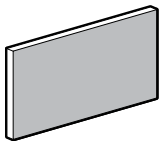

Wall Mounted Tackboard

ZWHT7221	1.25 x 72 x 20.5-21	100	16.80	1.80	1	\$514
					2	\$591
					3	\$679
					4	\$780
					5	\$898

For use under **ZxxS210S/OSN** or **ZxxS330S/OSN** for a finished height of **71.5"/72"**. Standard with pre-mounted "J" bracket for wall mount applications. For use under **Z30S330S/OSN** for a finished height of **84"/84.5"**

• **NOTE:** Care should be taken to mount the units. Units should be mounted to wall studs using correct fasteners. Failure to do so may result in collapse of the unit and subsequent personal injury. **Mounting hardware not included.** Mounting hardware used should be based on wall material. Consult an installation professional for proper wall mounting.

Required Specifications

Fabric

21" WALL MOUNTED TACKBOARDS

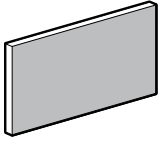

Wall Mounted Tackboard

MODEL#	DIMENSIONS D x W x H	FREIGHT CLASS	WT./LBS.	CUBIC FT.	FABRIC GRADE	LIST PRICE
ZWHT7821	1.25 x 78 x 20.5-21	92.5	18.20	1.80	1	\$541
					2	\$623
					3	\$716
					4	\$823
					5	\$945

For use under **ZxxS210S/OSN** or **ZxxS330S/OSN** for a finished height of **71.5"/72"**. Standard with pre-mounted "J" bracket for wall mount applications. For use under **Z30S330S/OSN** for a finished height of **84"/84.5"**

• **NOTE:** Care should be taken to mount the units. Units should be mounted to wall studs using correct fasteners. Failure to do so may result in collapse of the unit and subsequent personal injury. **Mounting hardware not included.** Mounting hardware used should be based on wall material. Consult an installation professional for proper wall mounting.

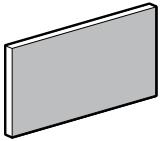

Wall Mounted Tackboard

ZWHT8421	1.25 x 84 x 20.5-21	92.5	19.60	1.80	1	\$589
					2	\$676
					3	\$777
					4	\$894
					5	\$1027

For use under **ZxxS210S/OSN** or **ZxxS330S/OSN** for a finished height of **71.5"/72"**. Standard with pre-mounted "J" bracket for wall mount applications. For use under **Z30S330S/OSN** for a finished height of **84"/84.5"**

• **NOTE:** Care should be taken to mount the units. Units should be mounted to wall studs using correct fasteners. Failure to do so may result in collapse of the unit and subsequent personal injury. **Mounting hardware not included.** Mounting hardware used should be based on wall material. Consult an installation professional for proper wall mounting.

25" WALL MOUNTED TACKBOARDS

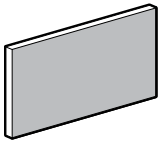

Wall Mounted Tackboard

MODEL#	DIMENSIONS	FREIGHT CLASS	WT./LBS.	CUBIC FT.	FABRIC GRADE	LIST PRICE
ZWHT3025	1.25 x 30 x 24.5-25	100	8.30	1	1	\$263
					2	\$302
					3	\$348
					4	\$398
					5	\$459

For use under **Z30S160S/OSN** for a finished height of **71.5"/72"**. Standard with pre-mounted "J" bracket for wall mount applications.

• **NOTE:** Care should be taken to mount the units. Units should be mounted to wall studs using correct fasteners. Failure to do so may result in collapse of the unit and subsequent personal injury. **Mounting hardware not included.** Mounting hardware used should be based on wall material. Consult an installation professional for proper wall mounting.

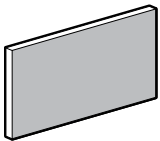

Wall Mounted Tackboard

ZWHT3625	1.25 x 36 x 24.5-25	92.5	10	1	1	\$291
					2	\$335
					3	\$386
					4	\$443
					5	\$508

For use under **Z36S160S/OSN** for a finished height of **71.5"/72"**. Standard with pre-mounted "J" bracket for wall mount applications.

• **NOTE:** Care should be taken to mount the units. Units should be mounted to wall studs using correct fasteners. Failure to do so may result in collapse of the unit and subsequent personal injury. **Mounting hardware not included.** Mounting hardware used should be based on wall material. Consult an installation professional for proper wall mounting.

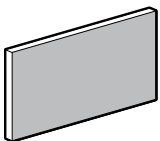

Wall Mounted Tackboard

ZWHT4225	1.25 x 42 x 24.5-25	92.5	11.70	1	1	\$338
					2	\$389
					3	\$446
					4	\$513
					5	\$590

For use under **Z42S160S/OSN** for a finished height of **71.5"/72"**. Standard with pre-mounted "J" bracket for wall mount applications.

• **NOTE:** Care should be taken to mount the units. Units should be mounted to wall studs using correct fasteners. Failure to do so may result in collapse of the unit and subsequent personal injury. **Mounting hardware not included.** Mounting hardware used should be based on wall material. Consult an installation professional for proper wall mounting.

Required Specifications

Fabric

25" WALL MOUNTED TACKBOARDS

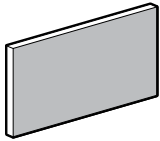

Wall Mounted Tackboard

MODEL#	DIMENSIONS	FREIGHT CLASS	WT/LBS.	CUBIC FT.	FABRIC GRADE	LIST PRICE
ZWHT4825	1.25 x 48 x 24.5-25	85	13.30	1	D x W x H	
					1	\$367
					2	\$422
					3	\$485
					4	\$557
5	\$641					

For use under **Z48S160S/OSN** for a finished height of **71.5"/72"**. Standard with pre-mounted "J" bracket for wall mount applications.

• **NOTE:** Care should be taken to mount the units. Units should be mounted to wall studs using correct fasteners. Failure to do so may result in collapse of the unit and subsequent personal injury. **Mounting hardware not included.** Mounting hardware used should be based on wall material. Consult an installation professional for proper wall mounting.

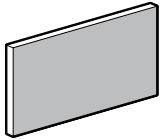

Wall Mounted Tackboard

ZWHT6025	1.25 x 60 x 24.5-25	100	16.70	1.80	1	\$454
					2	\$522
					3	\$599
					4	\$689
					5	\$793

For use under **Z60S160S/OSN** for a finished height of **71.5"/72"**. Standard with pre-mounted "J" bracket for wall mount applications.

• **NOTE:** Care should be taken to mount the units. Units should be mounted to wall studs using correct fasteners. Failure to do so may result in collapse of the unit and subsequent personal injury. **Mounting hardware not included.** Mounting hardware used should be based on wall material. Consult an installation professional for proper wall mounting.

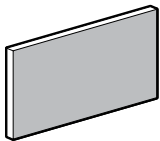

Wall Mounted Tackboard

ZWHT6625	1.25 x 66 x 24.5-25	92.5	18.30	1.80	1	\$483
					2	\$555
					3	\$637
					4	\$733
					5	\$843

For use under **ZxxS160S/OSN** for a finished height of **71.5"/72"**. Standard with pre-mounted "J" bracket for wall mount applications.

• **NOTE:** Care should be taken to mount the units. Units should be mounted to wall studs using correct fasteners. Failure to do so may result in collapse of the unit and subsequent personal injury. **Mounting hardware not included.** Mounting hardware used should be based on wall material. Consult an installation professional for proper wall mounting.

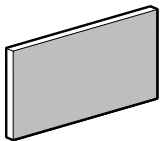

Wall Mounted Tackboard

ZWHT7225	1.25 x 72 x 24.5-25	92.5	20	1.80	1	\$530
					2	\$608
					3	\$699
					4	\$804
					5	\$923

For use under **ZxxS160S/OSN** for a finished height of **71.5"/72"**. Standard with pre-mounted "J" bracket for wall mount applications.

• **NOTE:** Care should be taken to mount the units. Units should be mounted to wall studs using correct fasteners. Failure to do so may result in collapse of the unit and subsequent personal injury. **Mounting hardware not included.** Mounting hardware used should be based on wall material. Consult an installation professional for proper wall mounting.

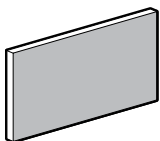

Wall Mounted Tackboard

ZWHT7825	1.25 x 78 x 24.5-25	85	21.70	1.80	1	\$558
					2	\$642
					3	\$737
					4	\$847
					5	\$974

For use under **ZxxS160S/OSN** for a finished height of **71.5"/72"**. Standard with pre-mounted "J" bracket for wall mount applications.

• **NOTE:** Care should be taken to mount the units. Units should be mounted to wall studs using correct fasteners. Failure to do so may result in collapse of the unit and subsequent personal injury. **Mounting hardware not included.** Mounting hardware used should be based on wall material. Consult an installation professional for proper wall mounting.

Required Specifications

Fabric

25" WALL MOUNTED TACKBOARDS

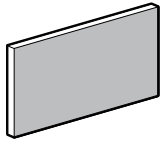

Wall Mounted Tackboard

MODEL#	DIMENSIONS	FREIGHT CLASS	WT/LBS.	CUBIC FT.	FABRIC GRADE	LIST PRICE
	D x W x H					
ZWHT8425	1.25 x 84 x 24.5-25	85	23.30	1.80	1	\$605
					2	\$696
					3	\$799
					4	\$918
					5	\$1055

For use under **ZxxS160S/OSN** for a finished height of **71.5"/72"**. Standard with pre-mounted "J" bracket for wall mount applications.

- **NOTE:** Care should be taken to mount the units. Units should be mounted to wall studs using correct fasteners. Failure to do so may result in collapse of the unit and subsequent personal injury. **Mounting hardware not included.** Mounting hardware used should be based on wall material. Consult an installation professional for proper wall mounting.

Required Specifications

Fabric

BOOKCASES

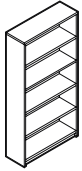

Bookcase - 72" High

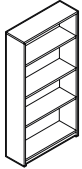

Bookcase - 65.5" High

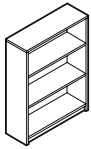

Bookcase - 48.5" High

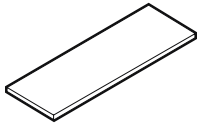

Bookcase Shelf

MODEL#	DIMENSIONS	FREIGHT CLASS	WT/LBS.	CUBIC FT.	1" TOP	1.5" TOP	GLAZE ADD	HP ADD
--------	------------	---------------	---------	-----------	--------	----------	-----------	--------

D x W x H

ZHBC72	12 x 36 x 71.9-72.4	125	176	23	\$863	\$912	N/A	N/A
--------	---------------------	-----	-----	----	--------------	--------------	-----	-----

One fixed shelf.

ZHBC65	12 x 36 x 65.5-66	125	156	21	\$836	\$884	N/A	N/A
--------	-------------------	-----	-----	----	--------------	--------------	-----	-----

One fixed shelf and two adjustable shelves.

ZHBC48	12 x 36 x 48.5-49	125	122	15.75	\$633	\$681	N/A	N/A
--------	-------------------	-----	-----	-------	--------------	--------------	-----	-----

Two adjustable shelves.

ZHSHELF	11 x 34 x .5-1	100	13	1.50	\$220	N/A	N/A	N/A
---------	----------------	-----	----	------	--------------	-----	-----	-----

Extra shelf for bookcases. 1" thick.

TABLE TOP BOOKCASES

NOTE: UNITS UNDER 30"W MUST BE SECURELY FASTENED TO THE WALL OR GANGED TO AN ADJACENT UNIT 30"W OR WIDER

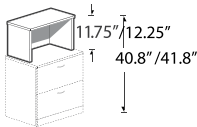

Table Top Bookcase 11.75"/12.25" High

Z36S12TN	16 x 36 x 11.25-11.75	100	44.91	5.25	\$252	\$301	N/A	N/A
----------	-----------------------	-----	-------	------	--------------	--------------	-----	-----

Z30S12TN	16 x 30 x 11.25-11.75	100	39.33	4.30	\$230	\$272	N/A	N/A
----------	-----------------------	-----	-------	------	--------------	--------------	-----	-----

To be placed **on top of 29"/29.5" high units to achieve 40.8"/41.8" final height** or placed on top of **40.8"/41.3" high units to achieve 52.5"/53.5" final height.**

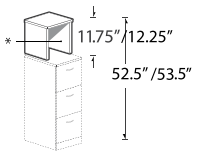

Table Top Bookcase 11.75"/12.25" High

Z21S12TN	16 x 21 x 11.25-11.75	100	28.87	3.10	\$192	\$225	N/A	N/A
----------	-----------------------	-----	-------	------	--------------	--------------	-----	-----

Z18S12TN	16 x 18 x 11.25-11.75	92.5	27.13	2.70	\$184	\$213	N/A	N/A
----------	-----------------------	------	-------	------	--------------	--------------	-----	-----

Z16S12TN	16 x 16 x 11.25-11.75	92.5	24.57	2.40	\$175	\$203	N/A	N/A
----------	-----------------------	------	-------	------	--------------	--------------	-----	-----

Z15S12TN	16 x 15 x 11.25-11.75	92.5	24.34	2.30	\$168	\$191	N/A	N/A
----------	-----------------------	------	-------	------	--------------	--------------	-----	-----

Z12S12TN	16 x 12 x 11.25-11.75	92.5	21.55	1.90	\$159	\$178	N/A	N/A
----------	-----------------------	------	-------	------	--------------	--------------	-----	-----

* Accepts collator 11" high

To be placed **on top of 29"/29.5" high units to achieve 40.8"/41.8" final height** or placed on top of **40.8"/41.3" high units to achieve 52.5"/53.5" final height.**

Required Specifications

- Top finish
- Base finish
- Top/Edge Detail

Optional Specifications

- Collator (Open Shelf)

TABLE TOP BOOKCASES

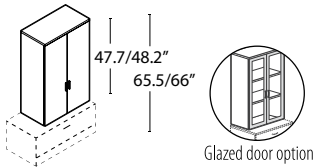

**Closed Table Top Bookcase
47.7" High**

MODEL#	DIMENSIONS D x W x H	FREIGHT CLASS	WT/LBS.	CUBIC FT.	1" TOP	1.5" TOP	GLAZE ADD	HP ADD
Z36S48T	36 x 16 x 47.7	125	149	20.25	\$1030	\$1079	\$1085	N/A
Z30S48T	30 x 16 x 47.7	125	130	17	\$940	\$982	\$936	N/A

Designed to be placed **on top of 17.87"/18.37" high units to achieve 65.5"/66" final height.**
Laminate doors are standard. **Includes one adjustable shelf.** Standard with lock.

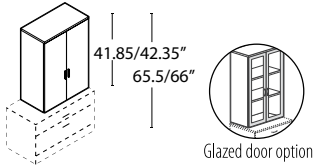

**Closed Table Top Bookcase
41" High**

Z36S41T	36 x 16 x 41.85	125	128	17.75	\$846	\$895	\$941	N/A
Z30S41T	30 x 16 x 41.85	125	111	15	\$739	\$781	\$819	N/A

Designed to be placed **on top of 23.75"/24.25" high units to achieve 65.5"/66" final height.**
Laminate doors are standard. **Includes one adjustable shelf.** Standard with lock.

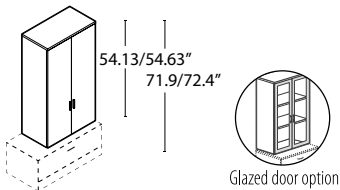

**Closed Table Top Bookcase
54" High**

Z36S54T	36 x 16 x 54.13	125	163	22.75	\$1030	\$1079	\$1085	N/A
Z30S54T	30 x 16 x 54.13	125	142	19	\$940	\$982	\$936	N/A

Designed to be placed **on top of 17.87"/18.37" high units to achieve 71.9"/72.4" final height.**
Laminate doors are standard. **Includes one adjustable shelf.** Standard with lock.

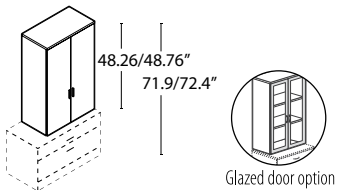

**Closed Table Top Bookcase
48" High**

Z36S49T	36 x 16 x 48.26	125	141	20.25	\$1080	\$1129	\$715	N/A
Z30S49T	30 x 16 x 48.26	125	123	17.25	\$968	\$1009	\$638	N/A

Designed to be placed **on top of 23.75"/24.25" high units to achieve 71.9"/72.4" final height.**
Laminate doors are standard. **Includes one adjustable shelf.** Standard with lock.

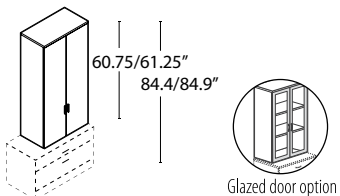

**Closed Table Top Bookcase
61" High**

Z36S61T	36 x 16 x 60.75	125	176	25.25	\$1276	\$1325	\$851	N/A
Z30S61T	30 x 16 x 60.75	125	153	21.25	\$1140	\$1181	\$759	N/A

Designed to be placed **on top of 23.75"/24.25" high units to achieve 84.4"/84.9" final height.**
Laminate doors are standard. **Includes one adjustable shelf.** Standard with lock.

Required Specifications

Top finish
Base finish
Top/Edge Detail

Optional Specifications

Glazing - Doors

TABLE TOP BOOKCASES

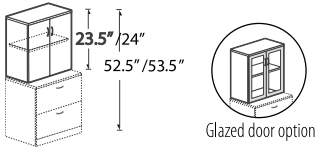

Table Top Bookcase 23.5"/24" High

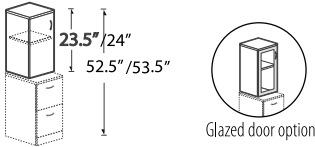

Table Top Bookcase with Door - LEFT 23.5"/24" High

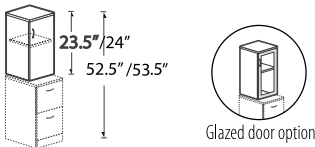

Table Top Bookcase with Door - RIGHT 23.5"/24" High

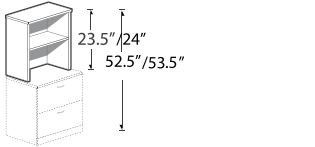

Table Top Bookcase 23.5"/24" High

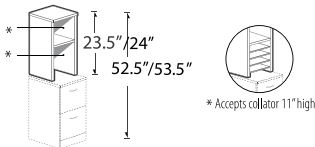

Table Top Bookcase 23.5"/24" High

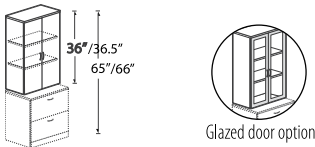

Table Top Bookcase with Doors 36"/36.5" High

MODEL#	DIMENSIONS	FREIGHT CLASS	WT./LBS.	CUBIC FT.	1" TOP	1.5" TOP	GLAZE ADD	HP ADD	
D x W x H									
Z36S23T	16 x 36 x 23-23.5	100	87.45	9.50	\$603	\$652	\$595	N/A	
Z30S23T	16 x 30 x 23-23.5	100	75.78	8	\$549	\$591	\$525	N/A	

Designed to be placed on top of 29"/29.5" high units to achieve 52.5"/53.5" final height. DO NOT USE ON TOP OF 40.8"/41.3" HIGH UNITS. Laminate doors are standard. Includes one adjustable shelf. Standard with lock.

Z21S23TL	16 x 21 x 23-23.5	92.5	58.83	5.75	\$430	\$462	\$324	N/A
Z18S23TL	16 x 18 x 23-23.5	92.5	54.65	5	\$415	\$443	\$295	N/A
Z16S23TL	16 x 16 x 23-23.5	92.5	46.71	4.50	\$367	\$395	\$289	N/A
Z15S23TL	16 x 15 x 23-23.5	92.5	46.06	4.20	\$348	\$371	\$260	N/A
Z12S23TL	16 x 12 x 23-23.5	92.5	40.77	3.50	\$325	\$344	\$235	N/A

Designed to be placed on top of 29"/29.5" high units to achieve 52.5"/53.5" final height. DO NOT USE ON TOP OF 40.8"/41.3" HIGH UNITS. Laminate door is standard. Includes one adjustable shelf. Standard with lock.

Z21S23TR	16 x 21 x 23-23.5	92.5	58.83	5.75	\$430	\$462	\$324	N/A
Z18S23TR	16 x 18 x 23-23.5	92.5	54.65	5	\$415	\$443	\$295	N/A
Z16S23TR	16 x 16 x 23-23.5	92.5	46.71	4.50	\$367	\$395	\$289	N/A
Z15S23TR	16 x 15 x 23-23.5	92.5	46.06	4.20	\$348	\$371	\$260	N/A
Z12S23TR	16 x 12 x 23-23.5	92.5	40.77	3.50	\$325	\$344	\$235	N/A

Designed to be placed on top of 29"/29.5" high units to achieve 52.5"/53.5" final height. DO NOT USE ON TOP OF 40.8"/41.3" HIGH UNITS. Laminate door is standard. Includes one adjustable shelf. Standard with lock.

Z36S23TN	16 x 36 x 23-23.5	125	69.06	9.50	\$395	\$444	N/A	N/A
Z30S23TN	16 x 30 x 23-23.5	125	60.33	8	\$362	\$403	N/A	N/A

Designed to be placed on top of 29"/29.5" high units to achieve 52.5"/53.5" final height. DO NOT USE ON TOP OF 40.8"/41.3" HIGH UNITS. Includes one adjustable shelf.

Z21S23TN	16 x 21 x 23-23.5	100	47.77	5.75	\$308	\$340	N/A	N/A
Z18S23TN	16 x 18 x 23-23.5	100	44.98	5	\$303	\$331	N/A	N/A
Z16S23TN	16 x 16 x 23-23.5	100	38.22	4.50	\$256	\$284	N/A	N/A
Z15S23TN	16 x 15 x 23-23.5	100	37	4.20	\$246	\$268	N/A	N/A
Z12S23TN	16 x 12 x 23-23.5	100	34.15	3.50	\$229	\$249	N/A	N/A

Designed to be placed on top of 29"/29.5" high units to achieve 52.5"/53.5" final height. DO NOT USE ON TOP OF 40.8"/41.3" HIGH UNITS. Includes one adjustable shelf.

Z36S36T	16 x 36 x 35.5-36	100	124.30	14.25	\$776	\$825	\$767	N/A
Z30S36T	16 x 30 x 35.5-36	100	106.67	12	\$672	\$713	\$671	N/A

Designed to be placed on top of 29"/29.5" high units to achieve 65"/66" final height. Laminate doors are standard. Includes two adjustable shelves. Standard with lock.

Required Specifications

Top finish
Base finish
Top/Edge Detail

Optional Specifications

Collator (Open Shelves)
Glazing - Doors

TABLE TOP BOOKCASES

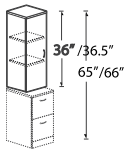

**Table Top Bookcase with Doors
36"/36.5" High - LEFT**

MODEL#	DIMENSIONS D x W x H	FREIGHT CLASS	WT/LBS.	CUBIC FT.	1" TOP	1.5" TOP	GLAZE ADD	HP ADD
Z21S36TL	16 x 21 x 35.5-36	100	82.99	8.75	\$549	\$582	\$420	N/A
Z18S36TL	16 x 18 x 35.5-36	100	74.72	7.50	\$526	\$554	\$380	N/A
Z16S36TL	16 x 16 x 35.5-36	92.5	67.82	6.75	\$480	\$508	\$374	N/A
Z15S36TL	16 x 15 x 35.5-36	92.5	66.46	6.50	\$456	\$479	\$332	N/A
Z12S36TL	16 x 12 x 35.5-36	92.5	59.30	5.25	\$424	\$443	\$300	N/A

Designed to be placed **on top of 29"/29.5" high units to achieve 65"/66" final height.** Laminate door is standard.
Includes two adjustable shelves. Standard with lock.

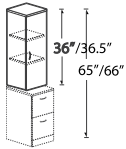

**Table Top Bookcase with Doors
36"/36.5" High - RIGHT**

Z21S36TR	16 x 21 x 35.5-36	100	82.99	8.75	\$549	\$582	\$420	N/A
Z18S36TR	16 x 18 x 35.5-36	100	74.72	7.50	\$526	\$554	\$380	N/A
Z16S36TR	16 x 16 x 35.5-36	92.5	67.82	6.75	\$480	\$508	\$374	N/A
Z15S36TR	16 x 15 x 35.5-36	92.5	66.46	6.50	\$456	\$479	\$332	N/A
Z12S36TR	16 x 12 x 35.5-36	92.5	59.30	5.25	\$424	\$443	\$300	N/A

Designed to be placed **on top of 29"/29.5" high units to achieve 65"/66" final height.** Laminate door is standard.
Includes two adjustable shelves. Standard with lock.

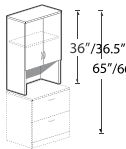

**Table Top Bookcase with Doors and
Cavity - 36"/36.5" High**

Z36S36TC	16 x 36 x 35.5-36	100	116.98	14.25	\$732	\$781	\$677	N/A
Z30S36TC	16 x 30 x 35.5-36	100	100.58	12	\$635	\$677	\$589	N/A

Designed to be placed **on top of 29"/29.5" high units to achieve 65"/66" final height.** Laminate doors are standard.
Includes one adjustable shelf. Standard with lock.

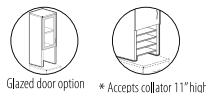
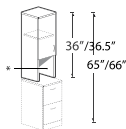

**Table Top Bookcase with Doors and
Cavity - 36"/36.5" High - LEFT**

Z21S36TCL	16 x 21 x 35.5-36	100	78.72	8.75	\$523	\$556	\$375	N/A
Z18S36TCL	16 x 18 x 35.5-36	100	71.07	7.50	\$504	\$533	\$338	N/A
Z16S36TCL	16 x 16 x 35.5-36	100	64.57	6.75	\$457	\$485	\$332	N/A
Z15S36TCL	16 x 15 x 35.5-36	100	63.42	6.50	\$439	\$461	\$294	N/A
Z12S36TCL	16 x 12 x 35.5-36	92.5	56.87	5.25	\$408	\$428	\$264	N/A

Designed to be placed **on top of 29"/29.5" high units to achieve 65"/66" final height.** Laminate door is standard.
Includes one adjustable shelf. Standard with lock.

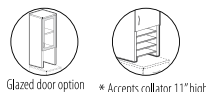
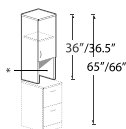

**Table Top Bookcase with Doors and
Cavity - 36"/36.5" High - RIGHT**

Z21S36TCR	16 x 21 x 35.5-36	100	78.72	8.75	\$523	\$556	\$375	N/A
Z18S36TCR	16 x 18 x 35.5-36	100	71.07	7.50	\$504	\$533	\$338	N/A
Z16S36TCR	16 x 16 x 35.5-36	100	64.57	6.75	\$457	\$485	\$332	N/A
Z15S36TCR	16 x 15 x 35.5-36	100	63.42	6.50	\$439	\$461	\$294	N/A
Z12S36TCR	16 x 12 x 35.5-36	92.5	56.87	5.25	\$408	\$428	\$264	N/A

Designed to be placed **on top of 29"/29.5" high units to achieve 65"/66" final height.** Laminate door is standard.
Includes one adjustable shelf. Standard with lock.

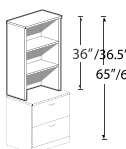

Table Top Bookcase 36"/36.5" High

Z36S36TN	16 x 36 x 35.5-36	125	95.31	14.25	\$521	\$571	N/A	N/A
Z30S36TN	16 x 30 x 35.5-36	125	82.38	12	\$444	\$486	N/A	N/A

Designed to be placed **on top of 29"/29.5" high units to achieve 65"/66" final height.** **Includes two adjustable shelves.**

Required Specifications

Top finish
Base finish
Top/Edge Detail

Optional Specifications

Collator (Open Shelves)
Glazing - Doors

TABLE TOP BOOKCASES

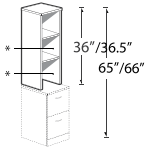

* Accepts collator 11\"/>

Table Top Bookcase 36\"/>

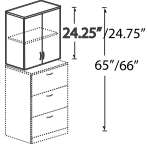

Glazed door option

Table Top Bookcase with Doors
24.25\"/>

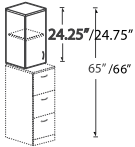

Glazed door option

Table Top Bookcase with Door - LEFT
24.25\"/>

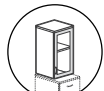
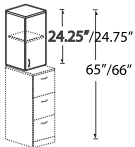

Glazed door option

Table Top Bookcase with Door - RIGHT
24.25\"/>

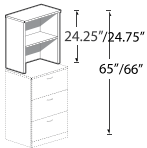
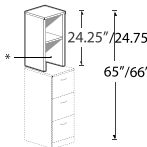

Table Top Bookcase
24.25\"/>



* Accepts collator 11\"/>

Table Top Bookcase
24.25\"/>

MODEL#	DIMENSIONS	FREIGHT CLASS	WT/LBS.	CUBIC FT.	1\"/>			
Z21S36TN	16 x 21 x 35.5-36	125	65.62	8.75	\$402	\$435	N/A	N/A
Z18S36TN	16 x 18 x 35.5-36	125	59.68	7.50	\$392	\$421	N/A	N/A
Z16S36TN	16 x 16 x 35.5-36	100	56	6.75	\$346	\$374	N/A	N/A
Z15S36TN	16 x 15 x 35.5-36	100	53.74	6.50	\$335	\$358	N/A	N/A
Z12S36TN	16 x 12 x 35.5-36	125	48.85	6.25	\$313	\$332	N/A	N/A

Designed to be placed on top of 29\"/>

MODEL#	DIMENSIONS	FREIGHT CLASS	WT/LBS.	CUBIC FT.	1\"/>			
Z36S24T	16 x 36 x 23.75-24.25	100	89.26	10	\$605	\$654	\$677	N/A
Z30S24T	16 x 30 x 23.75-24.25	100	77.47	8.25	\$552	\$593	\$589	N/A

Designed to be placed on top of 40.8\"/>

MODEL#	DIMENSIONS	FREIGHT CLASS	WT/LBS.	CUBIC FT.	1\"/>			
Z21S24TL	16 x 21 x 23.75-24.25	100	59.24	6	\$430	\$463	\$375	N/A
Z18S24TL	16 x 18 x 23.75-24.25	92.5	56.11	5.25	\$416	\$444	\$338	N/A
Z16S24TL	16 x 16 x 23.75-24.25	92.5	48.13	4.60	\$368	\$396	\$332	N/A
Z15S24TL	16 x 15 x 23.75-24.25	92.5	46.35	4.30	\$349	\$372	\$294	N/A
Z12S24TL	16 x 12 x 23.75-24.25	85	44.32	3.60	\$326	\$345	\$264	N/A

Designed to be placed on top of 40.8\"/>

MODEL#	DIMENSIONS	FREIGHT CLASS	WT/LBS.	CUBIC FT.	1\"/>			
Z21S24TR	16 x 21 x 23.75-24.25	100	59.24	6	\$430	\$463	\$375	N/A
Z18S24TR	16 x 18 x 23.75-24.25	92.5	56.11	5.25	\$416	\$444	\$338	N/A
Z16S24TR	16 x 16 x 23.75-24.25	92.5	48.13	4.60	\$368	\$396	\$332	N/A
Z15S24TR	16 x 15 x 23.75-24.25	92.5	46.35	4.30	\$349	\$372	\$294	N/A
Z12S24TR	16 x 12 x 23.75-24.25	85	44.32	3.60	\$326	\$345	\$264	N/A

Designed to be placed on top of 40.8\"/>

MODEL#	DIMENSIONS	FREIGHT CLASS	WT/LBS.	CUBIC FT.	1\"/>			
Z36S24TN	16 x 36 x 23.75-24.25	125	70.11	10	\$395	\$445	N/A	N/A
Z30S24TN	16 x 30 x 23.75-24.25	125	61.38	8.25	\$362	\$404	N/A	N/A

Designed to be placed on top of 40.8\"/>

MODEL#	DIMENSIONS	FREIGHT CLASS	WT/LBS.	CUBIC FT.	1\"/>			
Z21S24TN	16 x 21 x 23.75-24.25	125	47.77	6	\$308	\$341	N/A	N/A
Z18S24TN	16 x 18 x 23.75-24.25	100	46.03	5.25	\$303	\$332	N/A	N/A
Z16S24TN	16 x 16 x 23.75-24.25	100	39.27	4.60	\$257	\$285	N/A	N/A
Z15S24TN	16 x 15 x 23.75-24.25	100	37.99	4.30	\$246	\$269	N/A	N/A
Z12S24TN	16 x 12 x 23.75-24.25	92.5	37.30	3.60	\$230	\$249	N/A	N/A

Designed to be placed on top of 40.8\"/>

Required Specifications

- Top finish
- Base finish
- Top/Edge Detail

Optional Specifications

- Collator (Open Shelves)
- Glazing - Doors

TABLE TOP BOOKCASES

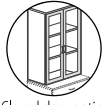
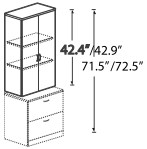

Glazed door option

Table Top Bookcase with Doors
42.4\"/>

MODEL#	DIMENSIONS D x W x H	FREIGHT CLASS	WT/LBS.	CUBIC FT.	1\"/>			
Z36S42T	16 x 36 x 41.9-42.4	100	137.40	16.75	\$846	\$895	\$941	N/A
Z30S42T	16 x 30 x 41.9-42.4	100	119.06	14	\$739	\$781	\$819	N/A

Designed to be placed **on top of 29\"/>**

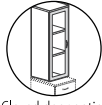
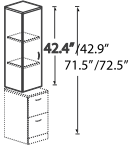

Glazed door option

Table Top Bookcase with Door - LEFT
42.4\"/>

Z21S42TL	16 x 21 x 41.9-42.4	300	119	70	\$599	\$632	\$520	N/A
Z18S42TL	16 x 18 x 41.9-42.4	85	117	8.75	\$575	\$603	\$467	N/A
Z16S42TL	16 x 16 x 41.9-42.4	300	112	62	\$518	\$546	\$463	N/A
Z15S42TL	16 x 15 x 41.9-42.4	250	109	54	\$491	\$513	\$406	N/A
Z12S42TL	16 x 12 x 41.9-42.4	250	105	49	\$456	\$476	\$366	N/A

Designed to be placed **on top of 29\"/>**

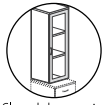
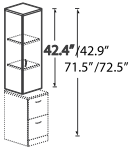

Glazed door option

Table Top Bookcase with Door - RIGHT
42.4\"/>

Z21S42TR	16 x 21 x 41.9-42.4	300	119	70	\$599	\$632	\$520	N/A
Z18S42TR	16 x 18 x 41.9-42.4	85	117	8.75	\$575	\$603	\$467	N/A
Z16S42TR	16 x 16 x 41.9-42.4	300	112	62	\$518	\$546	\$463	N/A
Z15S42TR	16 x 15 x 41.9-42.4	250	109	54	\$491	\$513	\$406	N/A
Z12S42TR	16 x 12 x 41.9-42.4	250	105	49	\$456	\$476	\$366	N/A

Designed to be placed **on top of 29\"/>**

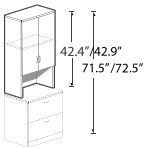

Glazed door option

Table Top Bookcase with Doors and Cavity
42.4\"/>

Z36S42TC	16 x 36 x 41.9-42.4	125	130.09	16.75	\$819	\$868	\$740	N/A
Z30S42TC	16 x 30 x 41.9-42.4	100	112.97	14	\$716	\$758	\$644	N/A

Designed to be placed **on top of 29\"/>**

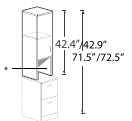

Glazed door option



* Accepts collator 11\"/>

Table Top Bookcase with Door and Cavity
42.4\"/>

Z21S42TCL	16 x 21 x 41.9-42.4	100	87.84	10	\$586	\$618	\$410	N/A
Z18S42TCL	16 x 18 x 41.9-42.4	100	79.83	8.75	\$562	\$590	\$369	N/A
Z16S42TCL	16 x 16 x 41.9-42.4	100	73.75	8	\$504	\$532	\$365	N/A
Z15S42TCL	16 x 15 x 41.9-42.4	100	70.71	7.50	\$480	\$502	\$322	N/A
Z12S42TCL	16 x 12 x 41.9-42.4	92.5	62.70	6	\$445	\$465	\$289	N/A

Designed to be placed **on top of 29\"/>**

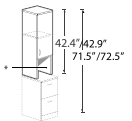

Glazed door option



* Accepts collator 11\"/>

Table Top Bookcase with Door and Cavity
42.4\"/>

Z21S42TCR	16 x 21 x 41.9-42.4	100	87.84	10	\$586	\$618	\$410	N/A
Z18S42TCR	16 x 18 x 41.9-42.4	100	79.83	8.75	\$562	\$590	\$369	N/A
Z16S42TCR	16 x 16 x 41.9-42.4	100	73.75	8	\$504	\$532	\$365	N/A
Z15S42TCR	16 x 15 x 41.9-42.4	100	70.71	7.50	\$480	\$502	\$322	N/A
Z12S42TCR	16 x 12 x 41.9-42.4	92.5	62.70	6	\$445	\$465	\$289	N/A

Designed to be placed **on top of 29\"/>**

Required Specifications

Top finish
Base finish
Top/Edge Detail

Optional Specifications

Collator (Open Shelves)
Glazing - Doors

TABLE TOP BOOKCASES

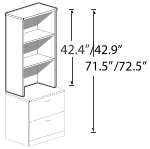
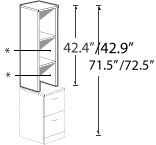
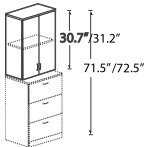

Table Top Bookcase
42.4\"/>



* Accepts collator 11\"/>

Table Top Bookcase
42.4\"/>



Glazed door option

Table Top Bookcase with Doors
30.7\"/>

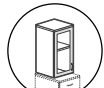
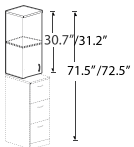

Glazed door option

Table Top Bookcase with Door
30.7\"/>

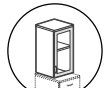
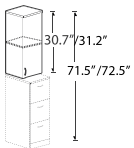

Glazed door option

Table Top Bookcase with Door
30.7\"/>

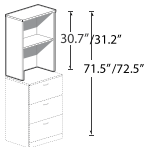

Table Top Bookcase
30.7\"/>

MODEL#	DIMENSIONS	FREIGHT CLASS	WT/LBS.	CUBIC FT.	1\"/>			
Z36S42TN	16 x 36 x 41.9-42.4	125	103.71	16.75	\$568	\$617	N/A	N/A
Z30S42TN	16 x 30 x 41.9-42.4	125	90.78	14	\$493	\$535	N/A	N/A

Designed to be placed on top of 29\"/>

MODEL#	D x W x H	FREIGHT CLASS	WT/LBS.	CUBIC FT.	1\"/>			
Z21S42TN	16 x 21 x 41.9-42.4	125	71.92	10	\$439	\$472	N/A	N/A
Z18S42TN	16 x 18 x 41.9-42.4	125	65.98	8.75	\$430	\$458	N/A	N/A
Z16S42TN	16 x 16 x 41.9-42.4	125	61.32	8	\$371	\$399	N/A	N/A
Z15S42TN	16 x 15 x 41.9-42.4	125	58.99	7.50	\$362	\$385	N/A	N/A
Z12S42TN	16 x 12 x 41.9-42.4	100	53.05	6	\$337	\$356	N/A	N/A

Designed to be placed on top of 29\"/>

MODEL#	D x W x H	FREIGHT CLASS	WT/LBS.	CUBIC FT.	1\"/>			
Z36S31T	16 x 36 x 30.2-30.7	100	104.19	12.25	\$665	\$714	\$740	N/A
Z30S31T	16 x 30 x 30.2-30.7	100	89.36	10.50	\$596	\$638	\$644	N/A

Designed to be placed on top of 40.8\"/>

MODEL#	D x W x H	FREIGHT CLASS	WT/LBS.	CUBIC FT.	1\"/>			
Z21S31TL	16 x 21 x 30.2-30.7	100	69.88	7.50	\$475	\$508	\$410	N/A
Z18S31TL	16 x 18 x 30.2-30.7	92.5	65.22	6.50	\$436	\$464	\$369	N/A
Z16S31TL	16 x 16 x 30.2-30.7	92.5	59.18	5.75	\$416	\$444	\$365	N/A
Z15S31TL	16 x 15 x 30.2-30.7	92.5	56.15	5.50	\$396	\$418	\$322	N/A
Z12S31TL	16 x 12 x 30.2-30.7	92.5	50.39	4.40	\$369	\$389	\$289	N/A

Designed to be placed on top of 40.8\"/>

MODEL#	D x W x H	FREIGHT CLASS	WT/LBS.	CUBIC FT.	1\"/>			
Z21S31TR	16 x 21 x 30.2-30.7	100	69.88	7.50	\$475	\$508	\$410	N/A
Z18S31TR	16 x 18 x 30.2-30.7	92.5	65.22	6.50	\$436	\$464	\$369	N/A
Z16S31TR	16 x 16 x 30.2-30.7	92.5	59.18	5.75	\$416	\$444	\$365	N/A
Z15S31TR	16 x 15 x 30.2-30.7	92.5	56.15	5.50	\$396	\$418	\$322	N/A
Z12S31TR	16 x 12 x 30.2-30.7	92.5	50.39	4.40	\$369	\$389	\$289	N/A

Designed to be placed on top of 40.8\"/>

MODEL#	D x W x H	FREIGHT CLASS	WT/LBS.	CUBIC FT.	1\"/>			
Z36S31TN	16 x 36 x 30.2-30.7	125	79.56	12.25	\$433	\$482	N/A	N/A
Z30S31TN	16 x 30 x 30.2-30.7	125	68.73	10.50	\$389	\$430	N/A	N/A

Designed to be placed on top of 40.8\"/>

Required Specifications

- Top finish
- Base finish
- Top/Edge Detail

Optional Specifications

- Collator (Open Shelves)
- Glazing - Doors

TABLE TOP BOOKCASES

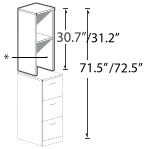

**Table Top Bookcase
30.7\"/>**

MODEL#	DIMENSIONS D x W x H	FREIGHT CLASS	WT./LBS.	CUBIC FT.	1\"/>			
Z21S31TN	16 x 21 x 30.2-30.7	125	55.12	7.50	\$341	\$373	N/A	N/A
Z18S31TN	16 x 18 x 30.2-30.7	100	52.33	6.50	\$312	\$340	N/A	N/A
Z16S31TN	16 x 16 x 30.2-30.7	100	47.67	5.75	\$294	\$322	N/A	N/A
Z15S31TN	16 x 15 x 30.2-30.7	100	45.34	5.50	\$285	\$307	N/A	N/A
Z12S31TN	16 x 12 x 30.2-30.7	100	41.50	4.40	\$265	\$284	N/A	N/A

Designed to be placed **on top of 40.8\"/>**

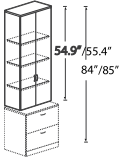

**Table Top Bookcase with Doors
54.9\"/>**

Z36S55T	16 x 36 x 54.4-54.9	100	174.25	21.50	\$1030	\$1079	\$1085	N/A
Z30S55T	16 x 30 x 54.4-54.9	100	152.16	18	\$940	\$982	\$936	N/A

Designed to be placed **on top of 29\"/>**

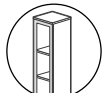
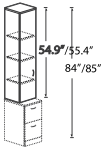

**Table Top Bookcase with Door - LEFT
54.9\"/>**

Z21S55TL	16 x 21 x 54.4-54.9	100	116.26	13	\$730	\$763	\$603	N/A
Z18S55TL	16 x 18 x 54.4-54.9	100	104.66	11.25	\$686	\$715	\$540	N/A
Z16S55TL	16 x 16 x 54.4-54.9	100	97.67	10	\$654	\$682	\$534	N/A
Z15S55TL	16 x 15 x 54.4-54.9	100	94.17	9.50	\$623	\$645	\$465	N/A
Z12S55TL	16 x 12 x 54.4-54.9	92.5	83.67	7.75	\$578	\$597	\$416	N/A

Designed to be placed **on top of 29\"/>**

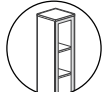
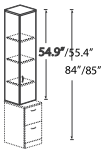

**Table Top Bookcase with Door - RIGHT
54.9\"/>**

Z21S55TR	16 x 21 x 54.4-54.9	100	116.26	13	\$730	\$763	\$603	N/A
Z18S55TR	16 x 18 x 54.4-54.9	100	104.66	11.25	\$686	\$715	\$540	N/A
Z16S55TR	16 x 16 x 54.4-54.9	100	97.67	10	\$654	\$682	\$534	N/A
Z15S55TR	16 x 15 x 54.4-54.9	100	94.17	9.50	\$623	\$645	\$465	N/A
Z12S55TR	16 x 12 x 54.4-54.9	92.5	83.67	7.75	\$578	\$597	\$416	N/A

Designed to be placed **on top of 29\"/>**

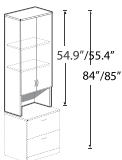

**Table Top Bookcase with Doors
and Cavity 54.9\"/>**

Z36S55TC	16 x 36 x 54.4-54.9	125	166.94	21.50	\$1003	\$1052	\$945	N/A
Z30S55TC	16 x 30 x 54.4-54.9	100	146.06	18	\$916	\$958	\$822	N/A

Designed to be placed **on top of 29\"/>**

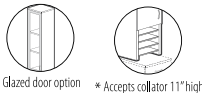
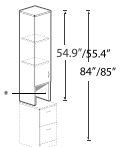

**Table Top Bookcase with Door - LEFT
and Cavity 54.9\"/>**

Z21S55TCL	16 x 21 x 54.4-54.9	100	112	13	\$705	\$737	\$522	N/A
Z18S55TCL	16 x 18 x 54.4-54.9	100	101.01	11.25	\$664	\$692	\$469	N/A
Z16S55TCL	16 x 16 x 54.4-54.9	100	94.42	10	\$629	\$658	\$464	N/A
Z15S55TCL	16 x 15 x 54.4-54.9	100	91.12	9.50	\$600	\$623	\$408	N/A
Z12S55TCL	16 x 12 x 54.4-54.9	92.5	81.24	7.75	\$558	\$577	\$368	N/A

Designed to be placed **on top of 29\"/>**

Required Specifications

Top finish
Base finish
Top/Edge Detail

Optional Specifications

Collator (Open Shelves)
Glazing - Doors

TABLE TOP BOOKCASES

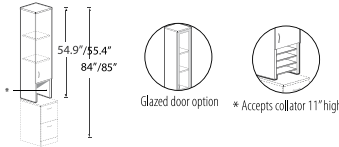

Table Top Bookcase with Door - RIGHT and Cavity - 54.9\"/>

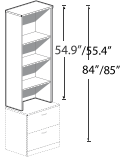

Table Top Bookcase 54.9\"/>

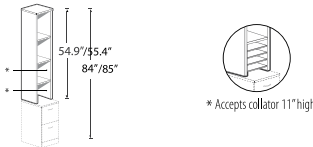

Table Top Bookcase 54.9\"/>

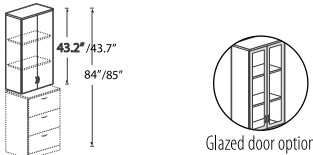

Table Top Bookcase with Doors 43.2\"/>

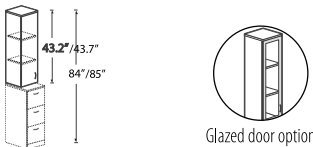

Table Top Bookcase with Door 43.2\"/>



Table Top Bookcase with Door 43.2\"/>

MODEL#	DIMENSIONS	FREIGHT CLASS	WT/LBS.	CUBIC FT.	1\"/>				
D x W x H									
Z21S55TCR	16 x 21 x 54.4-54.9	100	112	13	\$705	\$737	\$522	N/A	
Z18S55TCR	16 x 18 x 54.4-54.9	100	101.01	11.25	\$664	\$692	\$469	N/A	
Z16S55TCR	16 x 16 x 54.4-54.9	100	94.42	10	\$629	\$658	\$464	N/A	
Z15S55TCR	16 x 15 x 54.4-54.9	100	91.12	9.50	\$600	\$623	\$408	N/A	
Z12S55TCR	16 x 12 x 54.4-54.9	92.5	81.24	7.75	\$558	\$577	\$368	N/A	

Designed to be placed **on top of 29\"/>**

Z36S55TN	16 x 36 x 54.4-54.9	125	129.96	21.50	\$685	\$734	N/A	N/A
Z30S55TN	16 x 30 x 54.4-54.9	125	114.93	18	\$637	\$678	N/A	N/A

Designed to be placed **on top of 29\"/>**

Z21S55TN	16 x 21 x 54.4-54.9	125	89.77	13	\$533	\$565	N/A	N/A
Z18S55TN	16 x 18 x 54.4-54.9	125	81.73	11.25	\$508	\$536	N/A	N/A
Z16S55TN	16 x 16 x 54.4-54.9	125	77.07	10	\$474	\$502	N/A	N/A
Z15S55TN	16 x 15 x 54.4-54.9	125	74.74	9.50	\$464	\$487	N/A	N/A
Z12S55TN	16 x 12 x 54.4-54.9	100	67.75	7.75	\$433	\$452	N/A	N/A

Designed to be placed **on top of 29\"/>**

Z36S43T	16 x 36 x 42.7-43.2	100	139.22	17	\$864	\$913	\$945	N/A
Z30S43T	16 x 30 x 42.7-43.2	100	120.76	14.50	\$739	\$781	\$822	N/A

Designed to be placed **on top of 40.8\"/>**

Z21S43TL	16 x 21 x 42.7-43.2	100	93.62	10.25	\$612	\$644	\$522	N/A
Z18S43TL	16 x 18 x 42.7-43.2	100	84.94	9	\$586	\$614	\$469	N/A
Z16S43TL	16 x 16 x 42.7-43.2	100	78.42	8	\$525	\$553	\$464	N/A
Z15S43TL	16 x 15 x 42.7-43.2	92.5	75.16	7.50	\$493	\$515	\$408	N/A
Z12S43TL	16 x 12 x 42.7-43.2	92.5	66.48	6.25	\$457	\$477	\$368	N/A

Designed to be placed **on top of 40.8\"/>**

Z21S43TR	16 x 21 x 42.7-43.2	100	93.62	10.25	\$612	\$644	\$522	N/A
Z18S43TR	16 x 18 x 42.7-43.2	100	84.94	9	\$586	\$614	\$469	N/A
Z16S43TR	16 x 16 x 42.7-43.2	100	78.42	8	\$525	\$553	\$464	N/A
Z15S43TR	16 x 15 x 42.7-43.2	92.5	75.16	7.50	\$493	\$515	\$408	N/A
Z12S43TR	16 x 12 x 42.7-43.2	92.5	66.48	6.25	\$457	\$477	\$368	N/A

Designed to be placed **on top of 40.8\"/>**

Required Specifications

- Top finish
- Base finish
- Top/Edge Detail

Optional Specifications

- Collator (Open Shelves)
- Glazing - Doors

TABLE TOP BOOKCASES

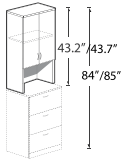

Glazed door option

Table Top Bookcase with Doors and Cavity - 43.2"/43.7" High*

MODEL#	DIMENSIONS D x W x H	FREIGHT CLASS	WT/LBS.	CUBIC FT.	1" TOP	1.5" TOP	GLAZE ADD	HP ADD
Z36S43TC	16 x 36 x 42.7-43.2	125	131.91	17	\$836	\$885	\$743	N/A
Z30S43TC	16 x 30 x 42.7-43.2	125	114.67	14.50	\$731	\$772	\$633	N/A

Designed to be placed **on top of 40.8"/41.3" high units to achieve 84"/85" final height.** Laminate doors are standard. **DO NOT USE ON TOP OF 29"/29.5 HIGH UNITS. Includes two adjustable shelves.** Standard with lock.

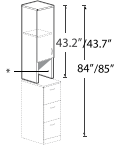

Glazed door option



* Accepts collator 11" high

Table Top Bookcase with Door and Cavity - 43.2"/43.7" High - LEFT**

Z21S43TCL	16 x 21 x 42.7-43.2	100	89.36	10.25	\$596	\$629	\$409	N/A
Z18S43TCL	16 x 18 x 42.7-43.2	100	81.29	9	\$571	\$599	\$368	N/A
Z16S43TCL	16 x 16 x 42.7-43.2	100	75.17	8	\$511	\$539	\$364	N/A
Z15S43TCL	16 x 15 x 42.7-43.2	100	72.11	7.50	\$482	\$504	\$321	N/A
Z12S43TCL	16 x 12 x 42.7-43.2	92.5	64.05	6.25	\$446	\$466	\$289	N/A

Designed to be placed **on top of 40.8"/41.3" high units to achieve 84"/85" final height.** Laminate door is standard. **DO NOT USE ON TOP OF 29"/29.5 HIGH UNITS. Includes one adjustable shelf.** Standard with lock.

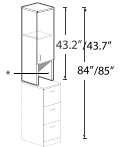

Glazed door option



* Accepts collator 11" high

Table Top Bookcase with Door and Cavity - 43.2"/43.7" High - RIGHT**

Z21S43TCR	16 x 21 x 42.7-43.2	100	89.36	10.25	\$596	\$629	\$409	N/A
Z18S43TCR	16 x 18 x 42.7-43.2	100	81.29	9	\$571	\$599	\$368	N/A
Z16S43TCR	16 x 16 x 42.7-43.2	100	75.17	8	\$511	\$539	\$364	N/A
Z15S43TCR	16 x 15 x 42.7-43.2	100	72.11	7.50	\$482	\$504	\$321	N/A
Z12S43TCR	16 x 12 x 42.7-43.2	92.5	64.05	6.25	\$446	\$466	\$289	N/A

Designed to be placed **on top of 40.8"/41.3" high units to achieve 84"/85" final height.** Laminate door is standard. **DO NOT USE ON TOP OF 29"/29.5 HIGH UNITS. Includes one adjustable shelf.** Standard with lock.

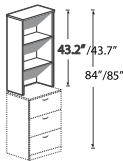

**Table Top Bookcase
43.2"/43.7" High**

Z36S43TN	16 x 36 x 42.7-43.2	125	104.76	17	\$585	\$634	N/A	N/A
Z30S43TN	16 x 30 x 42.7-43.2	125	91.83	14.50	\$507	\$549	N/A	N/A

Designed to be placed **on top of 40.8"/41.3" high units to achieve 84"/85" final height.** **DO NOT USE ON TOP OF 29"/29.5 HIGH UNITS. Includes two adjustable shelves.**

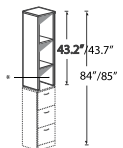

* Accepts collator 11" high

**Table Top Bookcase*
43.2"/43.7" High**

Z21S43TN	16 x 21 x 42.7-43.2	125	72.97	10.25	\$451	\$484	N/A	N/A
Z18S43TN	16 x 18 x 42.7-43.2	125	67.03	9	\$438	\$466	N/A	N/A
Z16S43TN	16 x 16 x 42.7-43.2	125	62.37	8	\$377	\$405	N/A	N/A
Z15S43TN	16 x 15 x 42.7-43.2	100	60.04	7.50	\$363	\$386	N/A	N/A
Z12S43TN	16 x 12 x 42.7-43.2	100	54.10	6.25	\$338	\$357	N/A	N/A

Designed to be placed **on top of 40.8"/41.3" high units to achieve 84"/85" final height.** **DO NOT USE ON TOP OF 29"/29.5 HIGH UNITS. Includes two adjustable shelves.**

Required Specifications

Top finish
Base finish
Top/edge detail

Optional Specifications

Collator**
Glazed doors*

END SHELVES

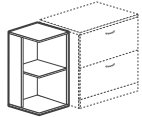

End Shelf - LEFT 29"/29.5" High*

MODEL#	DIMENSIONS	FREIGHT CLASS	WT/LBS.	CUBIC FT.	1" TOP	1.5" TOP	GLAZE ADD	HP ADD
D x W x H								
Z24L2ESHL	24 x 24 x 29.5-30	70	99.75	4.75	\$501	\$542	N/A	\$97
Z20M2ESHL	20 x 20 x 29.5-30	70	76.65	3.75	\$416	\$446	N/A	\$61
Z16S2ESHL	16 x 16 x 29.5-30	65	53.55	2.25	\$352	\$380	N/A	\$61

For use at **LEFT end of 29"/29.5"H units. One adjustable shelf.** Shipped RTA (ready to assemble).

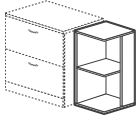

End Shelf - RIGHT 29"/29.5" High*

Z24L2ESHR	24 x 24 x 29.5-30	70	99.75	4.75	\$501	\$542	N/A	\$97
Z20M2ESHR	20 x 20 x 29.5-30	70	76.65	3.75	\$416	\$446	N/A	\$61
Z16S2ESHR	16 x 16 x 29.5-30	65	53.55	2.25	\$352	\$380	N/A	\$61

For use at **RIGHT end of 29"/29.5"H units. One adjustable shelf.** Shipped RTA (ready to assemble).

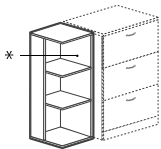

* Accepts collator 11" high

End Shelf - LEFT 40.8"/41.3" High**

Z24L4ESHL	24 x 24 x 41.3-41.8	65	130.20	4.75	\$643	\$685	N/A	N/A
Z20M4ESHL	20 x 20 x 41.3-41.8	60	101	3.25	\$540	\$570	N/A	N/A
Z16S4ESHL	16 x 16 x 41.3-41.8	65	73.87	2.50	\$458	\$486	N/A	N/A

For use at **LEFT end of 40.8"/41.3"H units. Two adjustable shelves.** Shipped RTA (ready to assemble).

- Collator only available on **Z16S4ESHL**

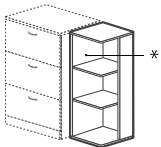

* Accepts collator 11" high

End Shelf - RIGHT 40.8"/41.3" High**

Z24L4ESHR	24 x 24 x 41.3-41.8	65	130.20	4.75	\$643	\$685	N/A	N/A
Z20M4ESHR	20 x 20 x 41.3-41.8	60	101	3.25	\$540	\$570	N/A	N/A
Z16S4ESHR	16 x 16 x 41.3-41.8	65	73.87	2.50	\$458	\$486	N/A	N/A

For use at **RIGHT end of 40.8"/41.3"H units. Two adjustable shelves.** Shipped RTA (ready to assemble).

- Collator only available on **Z16S4ESHR**

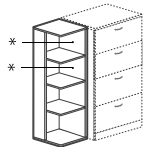

* Accepts collator 11" high

End Shelf - LEFT 52.5"/53" High**

Z24L5ESHL	24 x 24 x 53-53.5	60	162.75	4.75	\$797	\$838	N/A	N/A
Z20M5ESHL	20 x 20 x 53-53.5	60	125.69	4	\$657	\$687	N/A	N/A
Z16S5ESHL	16 x 16 x 53-53.5	65	91.35	3.25	\$554	\$583	N/A	N/A

For use at **LEFT end of 52.5"/53"H units. Three adjustable shelves.** Shipped RTA (ready to assemble).

- Collator only available on **Z16S5ESHL**

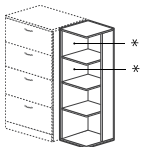

* Accepts collator 11" high

End Shelf - RIGHT 52.5"/53" High**

Z24L5ESHR	24 x 24 x 53-53.5	60	162.75	4.75	\$797	\$838	N/A	N/A
Z20M5ESHR	20 x 20 x 53-53.5	60	125.69	4	\$657	\$687	N/A	N/A
Z16S5ESHR	16 x 16 x 53-53.5	65	91.35	3.25	\$554	\$583	N/A	N/A

For use at **RIGHT end of 52.5"/53"H units. Three adjustable shelves.** Shipped RTA (ready to assemble).

- Collator only available on **Z16S5ESHR**

Required Specifications

Top finish
Base finish
Top/edge detail

Optional Specifications

Collator**
HP laminate*

END SHELVES

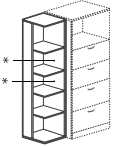

* Accepts collator 11" high

End Shelf - LEFT 65"/65.5" High

MODEL#	DIMENSIONS D x W x H	FREIGHT CLASS	WT/LBS.	CUBIC FT.	1" TOP	1.5" TOP	GLAZE ADD	HP ADD
Z24L6ESHL	24 x 24 x 65.5-66	60	196	6	\$932	\$974	N/A	N/A
Z20M6ESHL	20 x 20 x 65.5-66	60	152	5	\$775	\$805	N/A	N/A
Z16S6ESHL	16 x 16 x 65.5-66	65	111.30	4.25	\$660	\$688	N/A	N/A

For use at **LEFT end of 65"/65.5"H units. Four adjustable shelves.** Shipped RTA (ready to assemble).
 • Collator only available on **Z16S6ESHL**

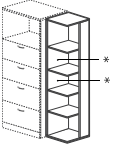

* Accepts collator 11" high

End Shelf - RIGHT 65"/65.5" High

Z24L6ESHR	24 x 24 x 65.5-66	60	196	6	\$932	\$974	N/A	N/A
Z20M6ESHR	20 x 20 x 65.5-66	60	152	5	\$775	\$805	N/A	N/A
Z16S6ESHR	16 x 16 x 65.5-66	65	111.30	4.25	\$660	\$688	N/A	N/A

For use at **RIGHT end of 65"/65.5"H units. Four adjustable shelves.** Shipped RTA (ready to assemble).
 • Collator only available on **Z16S6ESHR**

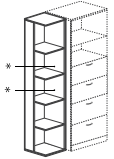

* Accepts collator 11" high

End Shelf - LEFT 71.5"/72" High

Z24L7ESHL	24 x 24 x 71.9-72.4	60	206.85	6.50	\$978	\$1019	N/A	N/A
Z20M7ESHL	20 x 20 x 71.9-72.4	65	160.65	5.75	\$817	\$847	N/A	N/A
Z16S7ESHL	16 x 16 x 71.9-72.4	65	117.60	4.75	\$694	\$722	N/A	N/A

For use at **LEFT end of 71.5"/72"H units. Four adjustable shelves.** Shipped RTA (ready to assemble).
 • Collator only available on **Z16S7ESHL**

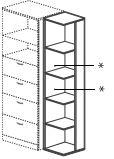

* Accepts collator 11" high

End Shelf - RIGHT 71.5"/72" High

Z24L7ESHR	24 x 24 x 71.9-72.4	60	206.85	6.50	\$978	\$1019	N/A	N/A
Z20M7ESHR	20 x 20 x 71.9-72.4	65	160.65	5.75	\$817	\$847	N/A	N/A
Z16S7ESHR	16 x 16 x 71.9-72.4	65	117.60	4.75	\$694	\$722	N/A	N/A

For use at **RIGHT end of 71.5"/72"H units. Four adjustable shelves.** Shipped RTA (ready to assemble).
 • Collator only available on **Z16S7ESHR**

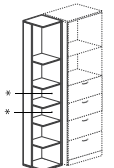

* Accepts collator 11" high

End Shelf - LEFT 84"/84.5" High

Z24L8ESHL	24 x 24 x 84.4-84.9	60	241.50	7.75	\$1123	\$1164	N/A	N/A
Z20M8ESHL	20 x 20 x 84.4-84.9	65	185.85	6.50	\$936	\$966	N/A	N/A
Z16S8ESHL	16 x 16 x 84.4-84.9	65	136.50	5.50	\$795	\$823	N/A	N/A

For use at **LEFT end of 84"/84.5"H units. Five adjustable shelves.** Shipped RTA (ready to assemble).
 • Collator only available on **Z16S8ESHL**

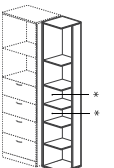

* Accepts collator 11" high

End Shelf - RIGHT 84"/84.5" High

Z24L8ESHR	24 x 24 x 84.4-84.9	60	241.50	7.75	\$1123	\$1164	N/A	N/A
Z20M8ESHR	20 x 20 x 84.4-84.9	65	185.85	6.50	\$936	\$966	N/A	N/A
Z16S8ESHR	16 x 16 x 84.4-84.9	65	136.50	5.50	\$795	\$823	N/A	N/A

For use at **RIGHT end of 84"/84.5"H units. Five adjustable shelves.** Shipped RTA (ready to assemble).
 • Collator only available on **Z16S8ESHR**

Required Specifications

- Top finish
- Base finish
- Top/edge detail

Optional Specifications

- Collator

TABLE TOP END SHELVES

MODEL# DIMENSIONS FREIGHT CLASS WT/LBS. CUBIC FT. 1" TOP 1.5" TOP GLAZE ADD HP ADD

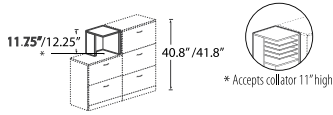

Table Top End Shelf - LEFT
11.75"/12.25" High

D x W x H									
Z16S12DL	16 x 16 x 11.25-11.75	70	26	1.60	\$179	\$207	N/A	N/A	

To be placed **on top of 29"/29.5" units**. For use at **LEFT end of 40.8"/41.8" H units**. Shipped RTA (ready to assemble).

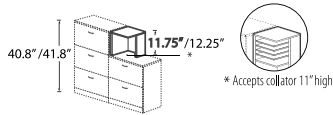

Table Top End Shelf - RIGHT
11.75"/12.25" High

Z16S12DR	16 x 16 x 11.25-11.75	70	26	1.60	\$179	\$207	N/A	N/A	
----------	-----------------------	----	----	------	--------------	--------------	-----	-----	--

To be placed **on top of 29"/29.5" units**. For use at **RIGHT end of 40.8"/41.8" H units**. Shipped RTA (ready to assemble).

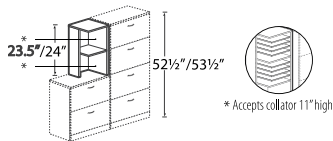

Table Top End Shelf - LEFT
23.5"/24" High

Z16S23DL	16 x 16 x 23-23.5	65	42	1.60	\$274	\$303	N/A	N/A	
----------	-------------------	----	----	------	--------------	--------------	-----	-----	--

To be placed **on top of 29"/29.5" units**. For use at **LEFT end of 52.5"/53" H units**. Shipped RTA (ready to assemble).
One adjustable shelf.

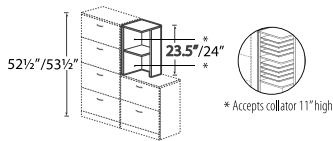

Table Top End Shelf - RIGHT
23.5"/24" High

Z16S23DR	16 x 16 x 23-23.5	65	42	1.60	\$274	\$303	N/A	N/A	
----------	-------------------	----	----	------	--------------	--------------	-----	-----	--

To be placed **on top of 29"/29.5" units**. For use at **RIGHT end of 52.5"/53" H units**. Shipped RTA (ready to assemble).
One adjustable shelf.

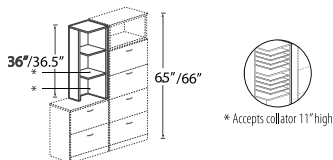

Table Top End Shelf - LEFT
36"/36.5" High

Z16S36DL	16 x 16 x 35.5-36	70	62.84	2.80	\$383	\$411	N/A	N/A	
----------	-------------------	----	-------	------	--------------	--------------	-----	-----	--

To be placed **on top of 29"/29.5" units**. For use at **LEFT end of 65"/65.5" H units**. Shipped RTA (ready to assemble).
Two adjustable shelves.

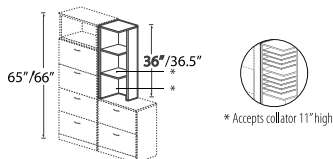

Table Top End Shelf - RIGHT
36"/36.5" High

Z16S36DR	16 x 16 x 35.5-36	70	62.84	2.80	\$383	\$411	N/A	N/A	
----------	-------------------	----	-------	------	--------------	--------------	-----	-----	--

To be placed **on top of 29"/29.5" units**. For use at **RIGHT end of 65"/65.5" H units**. Shipped RTA (ready to assemble).
Two adjustable shelves.

Required Specifications

Top finish
Base finish
Top/edge detail

Optional Specifications

Collator

TABLE TOP END SHELVES

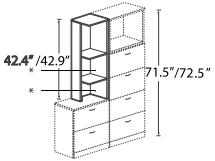

Table Top End Shelf - LEFT*
42.4"/42.9" High



* Accepts collator 11" high

MODEL#	DIMENSIONS D x W x H	FREIGHT CLASS	WT/LBS.	CUBIC FT.	1" TOP	1.5" TOP	GLAZE ADD	HP ADD
Z16S42DL	16-36 x 16 x 41.9-42.4	65	70	2.80	\$415	\$443	N/A	N/A

To be placed **on top of 29"/29.5" units**. For use at **LEFT end of 71.5"/72" H units**. Shipped RTA (ready to assemble).
Two adjustable shelves.

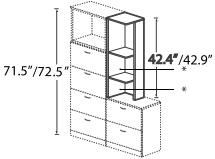

Table Top End Shelf - RIGHT*
42.4"/42.9" High



* Accepts collator 11" high

Z16S42DR	16-36 x 16 x 41.9-42.4	65	70	2.80	\$415	\$443	N/A	N/A
----------	------------------------	----	----	------	-------	-------	-----	-----

To be placed **on top of 29"/29.5" units**. For use at **RIGHT end of 71.5"/72" H units**. Shipped RTA (ready to assemble).
Two adjustable shelves.

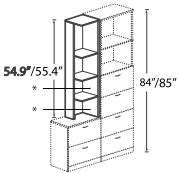

Table Top End Shelf - LEFT*
54.9"/55.4" High



* Accepts collator 11" high

Z16S55DL	16-36 x 16 x 54.4-54.9	60	89	2.80	\$511	\$540	N/A	N/A
----------	------------------------	----	----	------	-------	-------	-----	-----

To be placed **on top of 29"/29.5" units**. For use at **LEFT end of 84"/84.5" H units**. Shipped RTA (ready to assemble).
Three adjustable shelves.

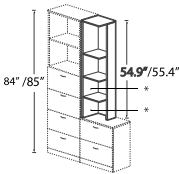

Table Top End Shelf - RIGHT*
54.9"/55.4" High



* Accepts collator 11" high

Z16S55DR	16-36 x 16 x 54.4-54.9	60	89	2.80	\$511	\$540	N/A	N/A
----------	------------------------	----	----	------	-------	-------	-----	-----

To be placed **on top of 29"/29.5" units**. For use at **RIGHT end of 84"/84.5" H units**. Shipped RTA (ready to assemble).
Three adjustable shelves.

ACCESSORIES

LIST PRICE

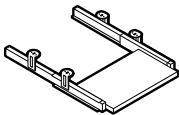

Pull-Out Keyboard

APOKL28	17 x 28 x 3.5	85	13	.90	\$253
APOKL22	17 x 22 x 3.5	85	12	.90	\$228

APOKL28 will accommodate keyboard and mousepad. **APOKL28** will only fit on a single pedestal desk, freestanding table, or **Z42205C**.

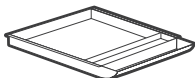

Pencil Drawer

W1518PDR	18 x 15 x 2.25	92.5	4	0.4	\$204
----------	----------------	------	---	-----	-------

Black ABS plastic. Provides space for writing instruments and small items at the workspace. Attaches to underside of any 24"D and 30"D worksurface with included roller slides. Shipped RTA (ready to assemble).

Required Specifications

Finishes
Top/edge detail*

Optional Specifications

Collator*

ACCESSORIES



L Bracket

MODEL#	DIMENSIONS	FREIGHT CLASS	WT/LBS.	CUBIC FT.	LIST PRICE
MLB90	D x W x H --	70	1	.01	\$43

Used to attach worksurfaces to end panels.



LEFT Skateboard

RIGHT

Z1425SKL (left)	13.9-36 x 25 x 3.2-3.7	100	13	1.50	\$101
Z1425SKR (right)	13.9-36 x 25 x 3.2-3.7	100	13	1.50	\$101

Mobile CPU holder designed to fit inside 'faux' pedestals of a single pedestal desk.

CENTER DRAWERS

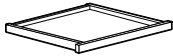

Center Drawer

MODEL#	DIMENSIONS	FREIGHT CLASS	WT/LBS.	CUBIC FT.	LIST PRICE
CD20	18 x 20 x 3	100	8	1	\$160

Laminate drawer front is attached to a 4-sided frame. Recommended for use on small L-shaped units, and on 30" x 60" and 66" desks.

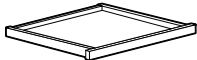

Center Drawer

CD28	18 x 28 x 3	150	5	1	\$210
------	-------------	-----	---	---	--------------

Laminate drawer front is attached to a 4-sided frame. Recommended for use on 36" x 72" desks.

Required Specifications

Finishes

Z ZIRA™ BOARDROOM - NOTES

TOP AND BASE FINISHES

ACJ	Absolute Acajou	HGT	Hayden Grey
ASN	Asian Night	QTM	Quartered Mahogany
AWC	Avant Cherry	SOG	Storm Grey
AWH	Avant Honey	TFW	Tiger Fruitwood
BLK	Black	TWL	Tiger Walnut
BRC	Brushed Cobalt	WHE	Walnut Heights
CMB	Clear Maple	WHC	White Chocolate
DES	Dark Espresso	WCR	Winter Cherry
DWT	Designer White	WGY	Willow Grey

BASE TRIM FINISHES

BRC	Brushed Cobalt
BLK	Black

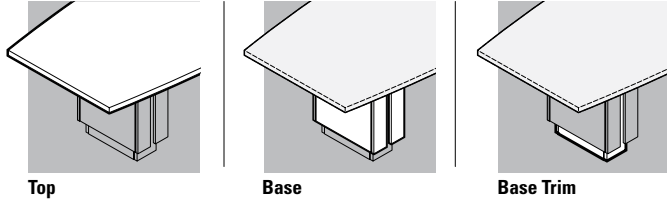

TOP THICKNESS/EDGE DETAIL



BASES

- 2 doors on base for wire management access from both sides

TOPS

- 96" tops are standard in one piece. All tops 120", 144" and 168" tops are standard in two equal size pieces. Woodgrain laminate finishes may NOT align where the two tops join. Tops 192" and larger are standard in 3 equal pieces.
- 96" tops are standard with **two bases**
- Tops 120", 144" and 168" are standard with **three bases**
- Tops 192" and larger are standard with **four bases**
- **Four** top shapes: **Boat shaped**, **Bow End**, **Rectangular** and **Racetrack**

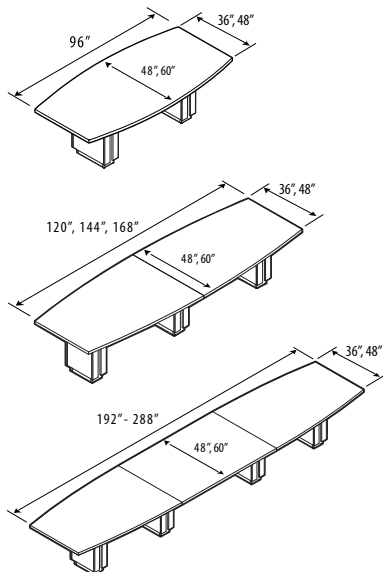

POWER & TECHNOLOGY SOLUTIONS

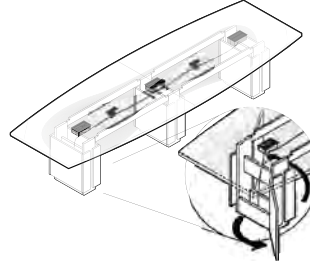

PRODUCT CODE DIAGRAM

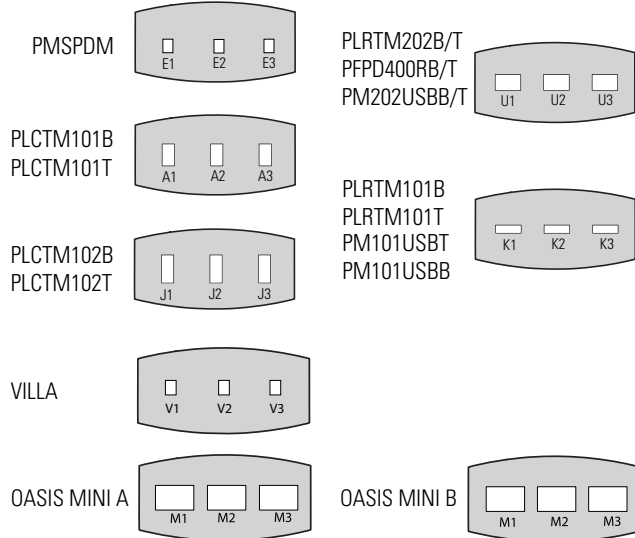

CUT-OUTS

- Optional cut-out available in standard worksurface locations (left, center or right) for all table shapes. **Add \$69 for each cut-out.**
- Select power block option from **Productivity Solutions** section
- Optional custom sized cut-out available in standard locations (left, center or right) for all table shapes. Submit appropriate form beginning on page 733 with order. **Add \$219** for each cut-out.
- Cut-outs may be placed at non-standard locations. Please contact customer care.
- Match power block desired with cut-out code and location from above grid.
Note: J1, J2 and J3 cut-outs not available on Zira collaborative tables.

AUDIOVISUAL

Three components:
Multimedia Cart

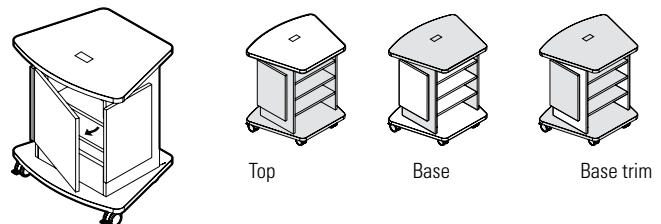

Lectern

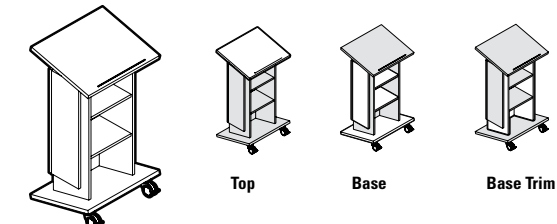

Visual Board

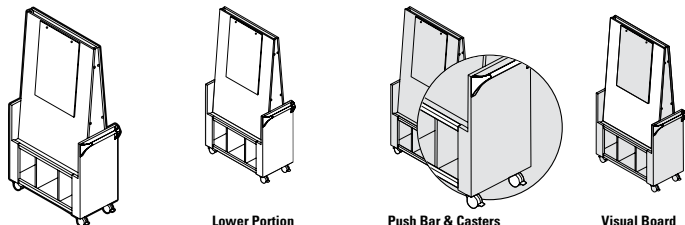

Multimedia Cart and Lectern:

- Available in all laminates listed above
- Color of casters will match base trim
- Offered in the following **top thickness and edge details:**



A3 1" top, standard



AR 1" top, bicut edge



C3 1.5" top, standard



CR 1.5" top, bicut edge



CF 1.5" top, fluted edge

Visual Board:

- Available in all laminates listed above
- Push Bar available in Black (BK) or Silver (SI)
- Color of casters and aluminum trim will match push bar
- Visual Board comes standard in white color

BUFFET

Three components: **Buffet Carts, Buffets** and **Serving Carts**

- Top and/or base available in all laminates
- Push Bar on Buffet Carts and Serving Carts and Aluminum Trim on Open and Mixed Buffets available in Black (BK) or Silver (SI)
- Optional glazing available on Serving Carts with doors and Buffets with doors

Buffet Carts

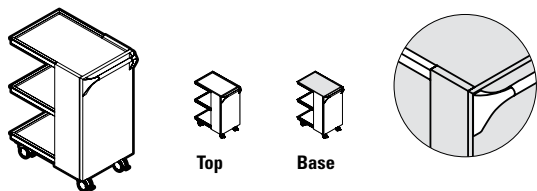

Serving Cart with Doors

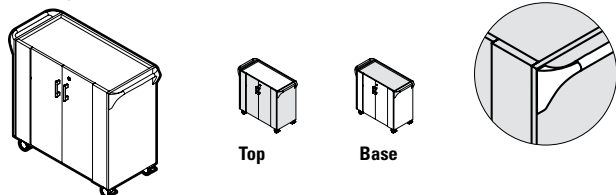

Serving Cart - Open

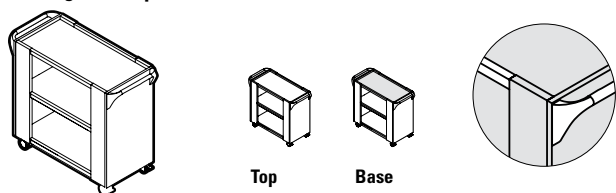

Buffet - Open

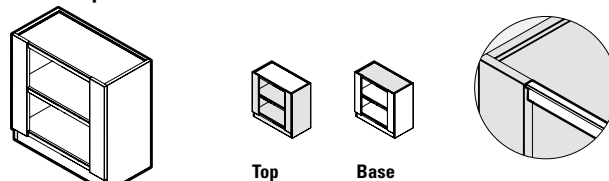

Buffet with Doors

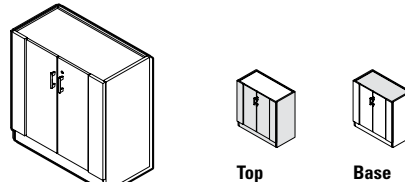

Buffet - Mixed

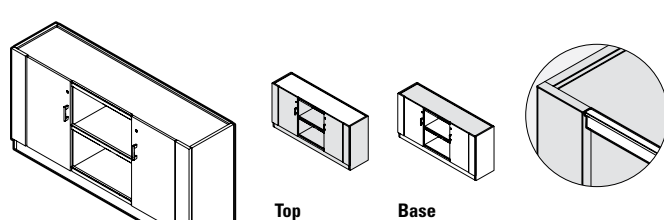

Glazing (Doors - Serving Cart and Buffets)



Z1 Frosted Glazing, Silver Frame



Z2 Frosted Glazing, Black Frame



Z3 Ribbed Glazing, Silver Frame



Z4 Ribbed Glazing, Black Frame

Handles

- Handles are standard on models with doors. Each handle is identified by the letters "HU", "HV", "HW", "HX", "HS", "HZ", "HO", "HQ", and "HR". To specify a handle, please specify the code after the model number.



HS Flared Silver



HV Square Edge Silver



HO Crescent Black



HW Flared Brass



HU Square Edge Black



HZ Dimpled Nickel



HX Flared Black



HQ Bar Silver



HR Bar Black

TABLE NOTES - ESTIMATED CAPACITY

- Use the following for determining the size of a table and the number of chairs needed for a conference area. All estimates are based on an average chair width of 23" with a 4" clearance between chairs. Adjust accordingly for a different chair size.

Top Size	Rectangular	Bow End	Boat	Racetrack
48x96	6-8	6-8	6-8	6-8
48x120	8-10	8-10	8-10	8-10
48x144	10-12	10-12	10-12	10-12
48x168	12-14	12-14	12-14	12-14
48x192	14-16	14-16	14-16	14-16
48x216	16-18	16-18	16-18	16-18
48x240	18-20	18-20	18-20	18-20
48x264	20-22	20-22	20-22	20-22
48x288	22-24	22-24	22-24	22-24

BOARDROOM TABLES

MODEL#	DIMENSIONS	FREIGHT CLASS	WT/LBS.	CUBIC FT.	1"TOP	1.5" TOP	GLAZE ADD	HP ADD
--------	------------	---------------	---------	-----------	-------	----------	-----------	--------

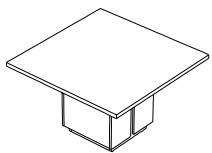

Boardroom Table - Square

D x W x H (1.5" TOP)								
Z3636SQ	36 x 36 x 30	85	129	10	N/A	\$1809	N/A	\$266
Z4242SQ	42 x 42 x 30	85	165.50	13.50	N/A	\$2059	N/A	\$365
Z4848SQ	48 x 48 x 30	85	190	14.24	N/A	\$2231	N/A	\$473
Z5454SQ	54 x 54 x 30	85	262	21.24	N/A	\$2496	N/A	\$600
Z6060SQ	60 x 60 x 30	85	300	22.74	N/A	\$2668	N/A	\$738

Square Table includes ONE BASE with wire access doors on each side of base. Shipped in 2 cartons.

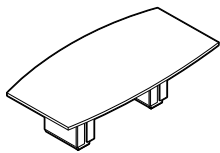

Boardroom Table - Boat Shaped

Z4896BE	48 x 96 x 30	70	342	21.95	N/A	\$2948	N/A	\$727
---------	--------------	----	-----	-------	-----	---------------	-----	--------------

Boat Shaped Table includes TWO BASES with wire access doors on each side of base and wire concealment runners between bases. Shipped in 3 cartons.

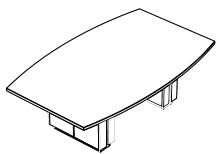

Boardroom Table - Boat Shaped

Z6096BE	60 x 96 x 30	85	432	35.39	N/A	\$4786	N/A	\$1181
---------	--------------	----	-----	-------	-----	---------------	-----	---------------

Boat Shaped Table includes TWO BASES with wire access doors on each side of base and wire concealment runners between bases. Shipped in 3 cartons.

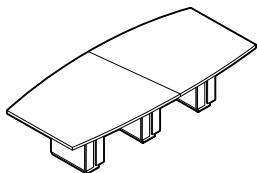

Boardroom Table - Boat Shaped

Z48120BE	48 x 120 x 30	70	452	23.48	N/A	\$4239	N/A	\$908
Z48144BE	48 x 144 x 30	70	502	25.72	N/A	\$4281	N/A	\$1089
Z48168BE	48 x 168 x 30	85	557	37.25	N/A	\$5714	N/A	\$1377

Boat Shaped Table includes THREE BASES with wire access doors on each side of base and wire concealment runners between bases. Z48144BE and Z48120BE shipped in 4 cartons. Z48168BE shipped in 5 cartons.

Required Specifications

Top finish
Top/edge detail
Base finish
Base trim finish

Optional Specifications

HP laminate
Additional grommet

Accessories

Power block

BOARDROOM TABLES

MODEL# DIMENSIONS FREIGHT CLASS WT/LBS. CUBIC FT. 1"TOP 1.5" TOP GLAZE ADD HP ADD

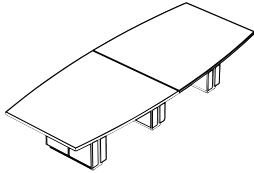

Boardroom Table - Boat Shaped

	D x W x H (1.5" TOP)								
Z60120BE	60 x 120 x 30	85	599	48.50	N/A	\$7256	N/A	\$1474	
Z60144BE	60 x 144 x 30	85	664.65	53.25	N/A	\$7767	N/A	\$1770	
Z60168BE	60 x 168 x 30	85	741.30	58	N/A	\$8375	N/A	\$2065	

Boat Shaped Table includes THREE BASES with wire access doors on each side of base and wire concealment runners between bases. Shipped in 5 cartons.

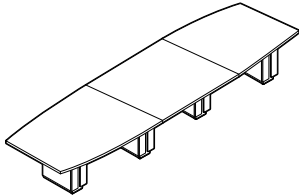

Boardroom Table - Boat Shaped

Z48192BE	48 x 192 x 30	70	688	45.66	N/A	\$7137	N/A	\$1573	
Z48216BE	48 x 216 x 30	70	746	48.67	N/A	\$7472	N/A	\$1770	
Z48240BE	48 x 240 x 30	70	803	51.68	N/A	\$7944	N/A	\$1966	
Z48264BE	48 x 264 x 30	70	855	54.69	N/A	\$8415	N/A	\$2163	
Z48288BE	48 x 288 x 30	70	906	57.69	N/A	\$8415	N/A	\$2359	

Boat Shaped Table includes FOUR BASES with wire access doors on each side of base and wire concealment runners between bases. Shipped in 7 cartons.

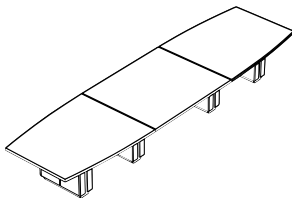

Boardroom Table - Boat Shaped

Z60192BE	60 x 192 x 30	85	912.45	71.19	N/A	\$10536	N/A	\$2359	
Z60216BE	60 x 216 x 30	85	980.70	75.94	N/A	\$11127	N/A	\$2653	
Z60240BE	60 x 240 x 30	85	1062.60	80.98	N/A	\$11603	N/A	\$2948	
Z60264BE	60 x 264 x 30	85	1129.80	85.73	N/A	\$12065	N/A	\$3243	
Z60288BE	60 x 288 x 30	85	1198.05	90.49	N/A	\$12800	N/A	\$3539	

Boat Shaped Table includes FOUR BASES with wire access doors on each side of base and wire concealment runners between bases. Shipped in 7 cartons.

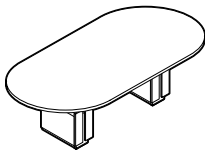

Boardroom Table - Racetrack

Z4896RTE	48 x 96 x 30	70	336	21.95	N/A	\$2867	N/A	\$727	
----------	--------------	----	-----	-------	-----	---------------	-----	--------------	--

Racetrack Shaped Table includes TWO BASES with wire access doors on each side of base and wire concealment runners between bases. Shipped in 3 cartons.

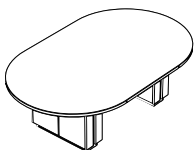

Boardroom Table - Racetrack

Z6096RTE	60 x 96 x 30	92.5	417	35.39	N/A	\$4786	N/A	\$1181	
----------	--------------	------	-----	-------	-----	---------------	-----	---------------	--

Racetrack Shaped Table includes TWO BASES with wire access doors on each side of base and wire concealment runners between bases. Shipped in 3 cartons.

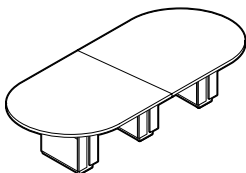

Boardroom Table - Racetrack

Z48120RTE	48 x 120 x 30	70	453	28.28	N/A	\$3987	N/A	\$908	
Z48144RTE	48 x 144 x 30	70	506	25.72	N/A	\$4250	N/A	\$1089	
Z48168RTE	48 x 168 x 30	70	563	37.25	N/A	\$5748	N/A	\$1297	

Racetrack Shaped Table includes THREE BASES with wire access doors on each side of base and wire concealment runners between bases. Z48144RTE and Z48120RTE shipped in 4 cartons. Z48168RTE shipped in 5 cartons.

Required Specifications

Top finish
Top/edge detail
Base finish
Base trim finish

Optional Specifications

HP laminate
Additional grommet

Accessories

Power block

BOARDROOM TABLES

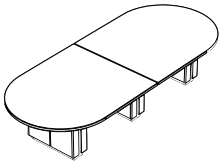

Boardroom Table - Racetrack

MODEL#	DIMENSIONS D x W x H (1.5" TOP)	FREIGHT CLASS	WT/LBS.	CUBIC FT.	1" TOP	1.5" TOP	GLAZE ADD	HP ADD
Z6012ORTE	60 x 120 x 30	85	585.90	48.50	N/A	\$7256	N/A	\$1474
Z60144ORTE	60 x 144 x 30	85	656.25	53.25	N/A	\$7767	N/A	\$1770
Z60168ORTE	60 x 168 x 30	85	737.10	58	N/A	\$8375	N/A	\$2065

Racetrack Shaped Table includes THREE BASES with wire access doors on each side of base and wire concealment runners between bases. Shipped in 5 cartons.

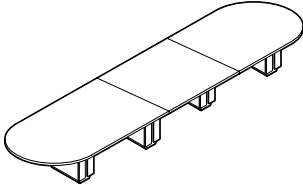

Boardroom Table - Racetrack

Z48192RTE	48 x 192 x 30	70	689	45.45	N/A	\$7172	N/A	\$1573
Z48216RTE	48 x 216 x 30	70	749	48.95	N/A	\$7507	N/A	\$1770
Z48240RTE	48 x 240 x 30	70	809	51.75	N/A	\$7978	N/A	\$1966
Z48264RTE	48 x 264 x 30	70	862	54.55	N/A	\$8449	N/A	\$2163
Z48288RTE	48 x 288 x 30	70	917	58.04	N/A	\$8449	N/A	\$2359

Racetrack Shaped Table includes FOUR BASES with wire access doors on each side of base and wire concealment runners between bases. Shipped in 7 cartons.

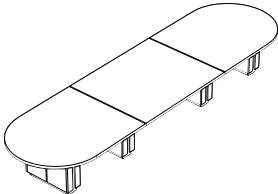

Boardroom Table - Racetrack

Z60192RTE	60 x 192 x 30	85	901.95	71.19	N/A	\$10536	N/A	\$2359
Z60216RTE	60 x 216 x 30	85	972.30	75.94	N/A	\$11127	N/A	\$2653
Z60240RTE	60 x 240 x 30	85	1057.35	80.98	N/A	\$11603	N/A	\$2948
Z60264RTE	60 x 264 x 30	85	1127.70	85.73	N/A	\$12065	N/A	\$3243
Z60288RTE	60 x 288 x 30	85	1198.05	90.49	N/A	\$12800	N/A	\$3539

Racetrack Shaped Table includes FOUR BASES with wire access doors on each side of base and wire concealment runners between bases. Shipped in 7 cartons.

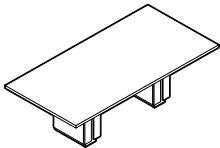

Boardroom Table - Rectangular

Z4896REE	48 x 96 x 30	70	356	21.95	N/A	\$2934	N/A	\$727
----------	--------------	----	-----	-------	-----	---------------	-----	--------------

Rectangular Shaped Table includes TWO BASES with wire access doors on each side of base and wire concealment runners between bases. Shipped in 3 cartons.

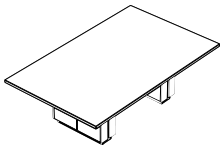

Boardroom Table - Rectangular

Z6096REE	60 x 96 x 30	85	448	35.39	N/A	\$4388	N/A	\$1181
----------	--------------	----	-----	-------	-----	---------------	-----	---------------

Rectangular Shaped Table includes TWO BASES with wire access doors on each side of base and wire concealment runners between bases. Shipped in 3 cartons.

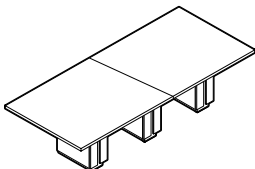

Boardroom Table - Rectangular

Z48120REE	48 x 120 x 30	70	472	23.48	N/A	\$3973	N/A	\$908
Z48144REE	48 x 144 x 30	70	525	25.72	N/A	\$4254	N/A	\$1089
Z48168REE	48 x 168 x 30	70	583	37.25	N/A	\$5664	N/A	\$1377

Rectangular Shaped Table includes THREE BASES with wire access doors on each side of base and wire concealment runners between bases. Z48144REE and Z48120REE shipped in 4 cartons. Z48168REE shipped in 5 cartons.

Required Specifications

Top finish
Top/edge detail
Base finish
Base trim finish

Optional Specifications

HP laminate
Additional grommet

Accessories

Power block

BOARDROOM TABLES

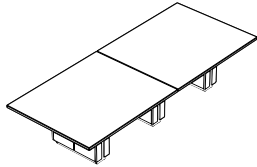

Boardroom Table - Rectangular

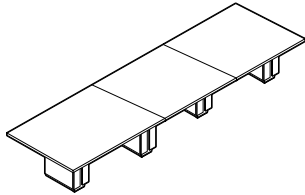

Boardroom Table - Rectangular

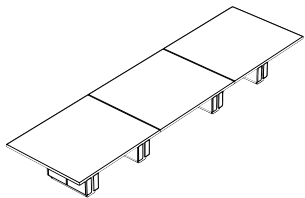

Boardroom Table - Rectangular

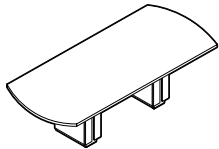

Boardroom Table - Bow End

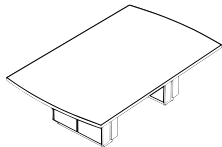

Boardroom Table - Bow End

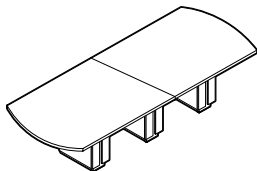

Boardroom Table - Bow End

MODEL#	DIMENSIONS D x W x H (1.5" TOP)	FREIGHT CLASS	WT/LBS.	CUBIC FT.	1" TOP	1.5" TOP	GLAZE ADD	HP ADD
Z60120REE	60 x 120 x 30	85	618	48.50	N/A	\$6652	N/A	\$1474
Z60144REE	60 x 144 x 30	85	688	53.25	N/A	\$7119	N/A	\$1770
Z60168REE	60 x 168 x 30	85	769	58	N/A	\$7668	N/A	\$2065

Rectangular Shaped Table includes THREE BASES with wire access doors on each side of base and wire concealment runners between bases. Shipped in 5 cartons.

Z48192REE	48 x 192 x 30	70	708	45.45	N/A	\$7089	N/A	\$1573
Z48216REE	48 x 216 x 30	70	768	48.95	N/A	\$7423	N/A	\$1770
Z48240REE	48 x 240 x 30	70	828	51.75	N/A	\$7894	N/A	\$1966
Z48264REE	48 x 264 x 30	70	882	54.55	N/A	\$8366	N/A	\$2163
Z48288REE	48 x 288 x 30	70	936	58.04	N/A	\$8366	N/A	\$2359

Rectangular Shaped Table includes FOUR BASES with wire access doors on each side of base and wire concealment runners between bases. Shipped in 7 cartons.

Z60192REE	60 x 192 x 30	85	941.85	71.12	N/A	\$9658	N/A	\$2359
Z60216REE	60 x 216 x 30	85	1003.80	75.94	N/A	\$10193	N/A	\$2653
Z60240REE	60 x 240 x 30	85	1088.85	80.98	N/A	\$10630	N/A	\$2948
Z60264REE	60 x 264 x 30	85	1159.20	85.73	N/A	\$11048	N/A	\$3243
Z60288REE	60 x 288 x 30	85	1229.55	90.49	N/A	\$11716	N/A	\$3539

Rectangular Shaped Table includes FOUR BASES with wire access doors on each side of base and wire concealment runners between bases. Shipped in 7 cartons.

Z4896BW	48 x 96 x 30	85	329	21.95	N/A	\$3038	N/A	\$727
---------	--------------	----	-----	-------	-----	---------------	-----	--------------

Bow End Table includes TWO BASES with wire access doors on each side of base and wire concealment runners between bases. Shipped in 3 cartons.

Z6096BW	60 x 96 x 30	85	436	35.39	N/A	\$4786	N/A	\$1181
---------	--------------	----	-----	-------	-----	---------------	-----	---------------

Bow End Table includes TWO BASES with wire access doors on each side of base and wire concealment runners between bases. Shipped in 3 cartons.

Z48120BW	48 x 120 x 30	70	476	29.35	N/A	\$4047	N/A	\$908
Z48144BW	48 x 144 x 30	70	513	25.72	N/A	\$4333	N/A	\$1089
Z48168BW	48 x 168 x 30	70	573	37.25	N/A	\$5689	N/A	\$1377

Bow End Table includes THREE BASES with wire access doors on each side of base and wire concealment runners between bases. Z48144BW and Z48120BW shipped in 4 cartons. Z48168BW shipped in 5 cartons.

Required Specifications

Top finish
Top/edge detail
Base finish
Base trim finish

Optional Specifications

HP laminate
Additional grommet

Accessories

Power block

BOARDROOM TABLES

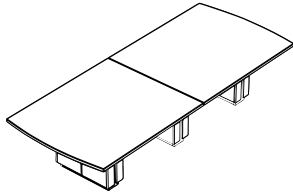

Boardroom Table - Bow End

MODEL#	DIMENSIONS D x W x H (1.5" TOP)	FREIGHT CLASS	WT/LBS.	CUBIC FT.	1" TOP	1.5" TOP	GLAZE ADD	HP ADD
Z60120BW	60 x 120 x 30	85	602	48.50	N/A	\$7256	N/A	\$1474
Z60144BW	60 x 144 x 30	85	673	53.25	N/A	\$7767	N/A	\$1770
Z60168BW	60 x 168 x 30	85	753	58	N/A	\$8375	N/A	\$2065

Bow End Table includes THREE BASES with wire access doors on each side of base and wire concealment runners between bases. Shipped in 5 cartons.

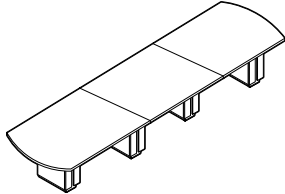

Boardroom Table - Bow End

Z48192BW	48 x 192 x 30	70	698	45.45	N/A	\$7114	N/A	\$1573
Z48216BW	48 x 216 x 30	70	758	48.95	N/A	\$7447	N/A	\$1770
Z48240BW	48 x 240 x 30	70	818	51.75	N/A	\$7918	N/A	\$1966
Z48264BW	48 x 264 x 30	70	872	54.55	N/A	\$8391	N/A	\$2163
Z48288BW	48 x 288 x 30	70	926	58.04	N/A	\$8391	N/A	\$2359

Bow End Table includes FOUR BASES with wire access doors on each side of base and wire concealment runners between bases. Shipped in 7 cartons.

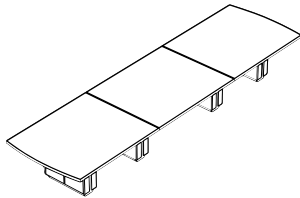

Boardroom Table - Bow End

Z60192BW	60 x 192 x 30	85	917.70	71.19	N/A	\$10536	N/A	\$2359
Z60216BW	60 x 216 x 30	85	988.05	75.94	N/A	\$11127	N/A	\$2653
Z60240BW	60 x 240 x 30	85	1073.10	80.98	N/A	\$11603	N/A	\$2948
Z60264BW	60 x 264 x 30	85	1143.45	85.73	N/A	\$12065	N/A	\$3243
Z60288BW	60 x 288 x 30	85	1213.80	90.49	N/A	\$12800	N/A	\$3539

Bow End Table includes FOUR BASES with wire access doors on each side of base and wire concealment runners between bases. Shipped in 7 cartons.

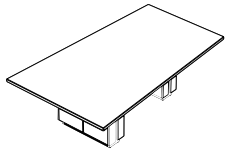

Boardroom Table - Wedge

Z6096WE	60 x 96 x 30	70	398	26.17	N/A	\$4786	N/A	\$1181
---------	--------------	----	-----	-------	-----	---------------	-----	---------------

Wedge Table includes TWO BASES with wire access doors on each side of base. Wedge tapers from 60" w to 48" w. Shipped in 3 cartons.

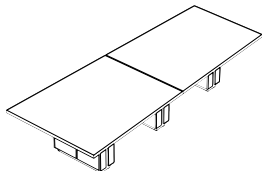

Boardroom Table - Wedge

Z60120WE	60 x 120 x 30	85	544.95	36.50	N/A	\$7256	N/A	\$1474
Z60144WE	60 x 144 x 30	70	603.75	39.50	N/A	\$7767	N/A	\$1770
Z60168WE	60 x 168 x 30	70	673.05	42.50	N/A	\$8375	N/A	\$2065

Wedge Table includes THREE BASES with wire access doors on each side of base. Wedge tapers from 60" w to 48" w. Shipped in 5 cartons.

Required Specifications

Top finish
Top/edge detail
Base finish
Base trim finish

Optional Specifications

HP laminate
Additional grommet

Accessories

Power block

MEDIA TABLES

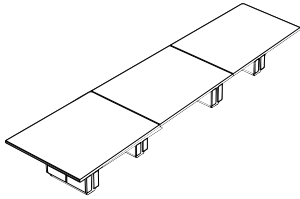

Boardroom Table - Wedge

MODEL#	DIMENSIONS D x W x H (1.5" TOP)	FREIGHT CLASS	WT/LBS.	CUBIC FT.	1" TOP	1.5" TOP	GLAZE ADD	HP ADD
Z60192WE	60 x 192 x 30	85	824.25	63.71	N/A	\$10536	N/A	\$2359
Z60216WE	60 x 216 x 30	85	884.10	68.25	N/A	\$11127	N/A	\$2653
Z60240WE	60 x 240 x 30	85	948.15	72.94	N/A	\$11603	N/A	\$2948
Z60264WE	60 x 264 x 30	85	1006.95	77.48	N/A	\$12065	N/A	\$3243
Z60288WE	60 x 288 x 30	85	1065.75	81.96	N/A	\$12800	N/A	\$3539

Wedge Table includes FOUR BASES with wire access doors on each side of base. Wedge tapers from 60" w to 48" w. Shipped in 7 cartons.

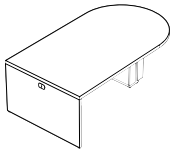

Media Table - D Island

Z4860DMIL	48 x 60 x 30	70	267	17.69	N/A	\$2983	N/A	\$591
Z4872DMIL	48 x 72 x 30	70	298.20	19.67	N/A	\$3199	N/A	\$709
Z4884DMIL	48 x 84 x 30	70	326.55	21.44	N/A	\$3406	N/A	\$827
Z4896DMIL	48 x 96 x 30	85	347.55	23.41	N/A	\$3607	N/A	\$944

D Media Island includes ONE BASE with wire access doors on each side of base and wire concealment runners between the base and the end panel. Grommet centered at the top of the end panel for wire pass through. Shipped in 3 cartons.

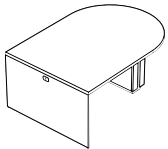

Media Table - D Island

Z6060DMIL	60 x 60 x 30	85	323.93	23.17	N/A	\$3578	N/A	\$738
Z6072DMIL	60 x 72 x 30	85	359.10	25.66	N/A	\$3833	N/A	\$886
Z6084DMIL	60 x 84 x 30	85	397.95	27.90	N/A	\$4088	N/A	\$1034
Z6096DMIL	60 x 96 x 30	85	433.65	30.39	N/A	\$4329	N/A	\$1181

D Media Island includes ONE BASE with wire access doors on each side of base and wire concealment runners between the base and the end panel. Grommet centered at the top of the end panel for wire pass through. Shipped in 3 cartons.

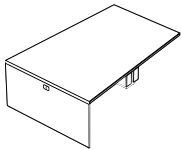

Media Table - D Wedge

Z6060WMIL	60 x 60 x 30	85	306.60	20.69	N/A	\$3578	N/A	\$738
Z6072WMIL	60 x 72 x 30	85	338.10	22.90	N/A	\$3833	N/A	\$886
Z6084WMIL	60 x 84 x 30	85	374.85	25.42	N/A	\$4088	N/A	\$1034
Z6096WMIL	60 x 96 x 30	85	407.40	27.90	N/A	\$4329	N/A	\$1181

Wedge Media Island includes ONE BASE with wire access doors on each side of base and wire concealment runners between the base and the end panel. Grommet centered at the top of the end panel for wire pass through. Wedge tapers from 60" w to 48" w. Shipped in 3 cartons.

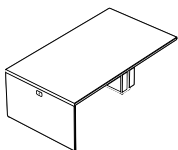

Media Table - Rectangular Island

Z4860RMIL	48 x 60 x 30	70	279.30	17.69	N/A	\$2746	N/A	\$591
Z4872RMIL	48 x 72 x 30	70	307.65	19.67	N/A	\$2944	N/A	\$709
Z4884RMIL	48 x 84 x 30	70	337.05	21.44	N/A	\$3131	N/A	\$827
Z4896RMIL	48 x 96 x 30	70	357	23.41	N/A	\$3312	N/A	\$944

Rectangular Media Island includes ONE BASE with wire access doors on each side of base and wire concealment runners between the base and the end panel. Grommet centered at the top of the end panel for wire pass through. Shipped in 3 cartons.

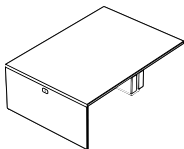

Media Table - Rectangular Island

Z6060RMIL	60 x 60 x 30	70	339.15	22.22	N/A	\$3287	N/A	\$738
Z6072RMIL	60 x 72 x 30	85	373.80	25.66	N/A	\$3518	N/A	\$886
Z6084RMIL	60 x 84 x 30	85	414.75	27.90	N/A	\$3749	N/A	\$1034
Z6096RMIL	60 x 96 x 30	85	449.40	30.39	N/A	\$3970	N/A	\$1181

Rectangular Media Island includes ONE BASE with wire access doors on each side of base and wire concealment runners between the base and the end panel. Grommet centered at the top of the end panel for wire pass through. Shipped in 3 cartons.

Required Specifications

Top finish
Top/edge detail
Base finish
Base trim finish

Optional Specifications

HP laminate
Additional grommet

Accessories

Power block

MEDIA TABLES

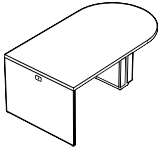

Media Table - D Island, 36" H

MODEL#	DIMENSIONS D x W x H (1.5" TOP)	FREIGHT CLASS	WT/LBS.	CUBIC FT.	1" TOP	1.5" TOP	GLAZE ADD	HP ADD
Z4860DMIM	48 x 60 x 36.5	70	291.90	19.19	N/A	\$3264	N/A	\$591
Z4872DMIM	48 x 72 x 36.5	70	321.30	21.17	N/A	\$3479	N/A	\$709
Z4884DMIM	48 x 84 x 36.5	70	349.65	22.90	N/A	\$3681	N/A	\$827
Z4896DMIM	48 x 96 x 36.5	85	370.65	24.91	N/A	\$3887	N/A	\$944

D Media Island includes ONE BASE with wire access doors on each side of base and wire concealment runners between the base and the end panel. Grommet centered at the top of the end panel for wire pass through. Shipped in 3 cartons.

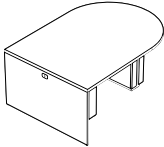

Media Table - D Island, 36" H

Z6060DMIM	60 x 60 x 36.5	85	352.28	25.42	N/A	\$3858	N/A	\$738
Z6072DMIM	60 x 72 x 36.5	85	386.40	27.66	N/A	\$4108	N/A	\$886
Z6084DMIM	60 x 84 x 36.5	85	426.30	30.15	N/A	\$4364	N/A	\$1034
Z6096DMIM	60 x 96 x 36.5	85	462	32.63	N/A	\$4604	N/A	\$1181

D Media Island includes ONE BASE with wire access doors on each side of base and wire concealment runners between the base and the end panel. Grommet centered at the top of the end panel for wire pass through. Shipped in 3 cartons.

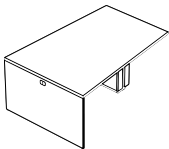

Media Table - D Wedge, 36" H

Z6060WMIM	60 x 60 x 36.5	85	331.80	22.16	N/A	\$3858	N/A	\$738
Z6072WMIM	60 x 72 x 36.5	85	364.35	24.67	N/A	\$4108	N/A	\$886
Z6084WMIM	60 x 84 x 36.5	70	424.20	26.92	N/A	\$4364	N/A	\$1034
Z6096WMIM	60 x 96 x 36.5	85	424.20	29.40	N/A	\$4604	N/A	\$1181

Wedge Media Island includes ONE BASE with wire access doors on each side of base and wire concealment runners between the base and the end panel. Grommet centered at the top of the end panel for wire pass through. Wedge tapers from 60" w to 48" w. Shipped in 3 cartons.

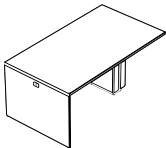

Media Table - Rectangular Island, 36" H

Z4860RMIM	48 x 60 x 36.5	70	301.35	19.19	N/A	\$2998	N/A	\$591
Z4872RMIM	48 x 72 x 36.5	70	330.75	21.17	N/A	\$3195	N/A	\$709
Z4884RMIM	48 x 84 x 36.5	70	360.15	22.90	N/A	\$3381	N/A	\$827
Z4896RMIM	48 x 96 x 36.5	70	380.10	24.91	N/A	\$3567	N/A	\$944

Rectangular Media Island includes ONE BASE with wire access doors on each side of base and wire concealment runners between the base and the end panel. Grommet centered at the top of the end panel for wire pass through. Shipped in 3 cartons.

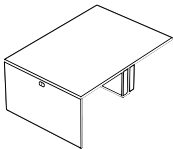

Media Table - Rectangular Island, 36" H

Z6060RMIM	60 x 60 x 36.5	85	367.50	25.42	N/A	\$3539	N/A	\$738
Z6072RMIM	60 x 72 x 36.5	85	402.15	27.66	N/A	\$3764	N/A	\$886
Z6084RMIM	60 x 84 x 36.5	85	442.05	30.15	N/A	\$4000	N/A	\$1034
Z6096RMIM	60 x 96 x 36.5	85	477.75	32.63	N/A	\$4220	N/A	\$1181

Rectangular Media Island includes ONE BASE with wire access doors on each side of base and wire concealment runners between the base and the end panel. Grommet centered at the top of the end panel for wire pass through. Shipped in 3 cartons.

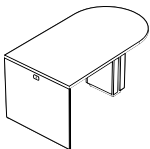

Media Table - D Island, 42" H

Z4860DMIH	48 x 60 x 42.5	70	312.90	20.69	N/A	\$3470	N/A	\$591
Z4872DMIH	48 x 72 x 42.5	70	342.30	22.66	N/A	\$3686	N/A	\$709
Z4884DMIH	48 x 84 x 42.5	70	371.70	24.40	N/A	\$3892	N/A	\$827
Z4896DMIH	48 x 96 x 42.5	85	391.65	26.41	N/A	\$4093	N/A	\$944

D Media Island includes ONE BASE with wire access doors on each side of base and wire concealment runners between the base and the end panel. Grommet centered at the top of the end panel for wire pass through. Shipped in 3 cartons.

Required Specifications

Top finish
Top/edge detail
Base finish
Base trim finish

Optional Specifications

HP laminate
Additional grommet

Accessories

Power block

MEDIA TABLES

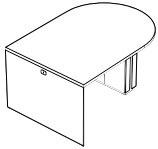

Media Table - D Island, 42”H

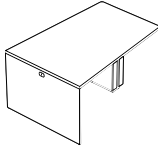

Media Table - Wedge, 42”H

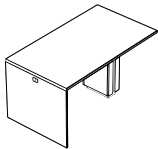

Media Table - Rectangular Island, 42”H

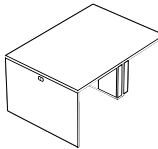

Media Table - Rectangular Island, 42”H

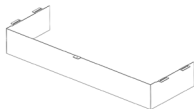

Media Table - Base Cover

MODEL#	DIMENSIONS D x W x H (1.5" TOP)	FREIGHT CLASS	WT/LBS.	CUBIC FT.	1" TOP	1.5" TOP	GLAZE ADD	HP ADD
Z6060DMIH	60 x 60 x 42.5	85	378	27.40	N/A	\$4063	N/A	\$738
Z6072DMIH	60 x 72 x 42.5	85	413.70	29.91	N/A	\$4313	N/A	\$886
Z6084DMIH	60 x 84 x 42.5	85	453.60	32.40	N/A	\$4575	N/A	\$1034
Z6096DMIH	60 x 96 x 42.5	85	488.25	34.88	N/A	\$4810	N/A	\$1181

D Media Island includes ONE BASE with wire access doors on each side of base and wire concealment runners between the base and the end panel. Grommet centered at the top of the end panel for wire pass through. Shipped in 3 cartons.

Z6060WMIH	60 x 60 x 42.5	85	355	23.92	N/A	\$4063	N/A	\$738
Z6072WMIH	60 x 72 x 42.5	85	387	26.17	N/A	\$4313	N/A	\$886
Z6084WMIH	60 x 84 x 42.5	85	424	28.65	N/A	\$4575	N/A	\$1034
Z6096WMIH	60 x 96 x 42.5	85	457	31.14	N/A	\$4810	N/A	\$1181

Wedge Media Island includes ONE BASE with wire access doors on each side of base and wire concealment runners between the base and the end panel. Grommet centered at the top of the end panel for wire pass through. Wedge tapers from 60”w to 48”w. Shipped in 3 cartons.

Z4860RMIH	48 x 60 x 42.5	70	324	20.69	N/A	\$3189	N/A	\$591
Z4872RMIH	48 x 72 x 42.5	70	353	22.66	N/A	\$3385	N/A	\$709
Z4884RMIH	48 x 84 x 42.5	70	382	24.40	N/A	\$3572	N/A	\$827
Z4896RMIH	48 x 96 x 42.5	70	402	26.41	N/A	\$3755	N/A	\$944

Rectangular Media Island includes ONE BASE with wire access doors on each side of base and wire concealment runners between the base and the end panel. Grommet centered at the top of the end panel for wire pass through. Shipped in 3 cartons.

Z6060RMIH	60 x 60 x 42.5	85	394	27.40	N/A	\$3729	N/A	\$738
Z6072RMIH	60 x 72 x 42.5	85	429	29.91	N/A	\$3955	N/A	\$886
Z6084RMIH	60 x 84 x 42.5	85	469	32.40	N/A	\$4192	N/A	\$1034
Z6096RMIH	60 x 96 x 42.5	85	504	34.88	N/A	\$4407	N/A	\$1181

Rectangular Media Island includes ONE BASE with wire access doors on each side of base and wire concealment runners between the base and the end panel. Grommet centered at the top of the end panel for wire pass through. Shipped in 3 cartons.

Z60BEC	12.2 x 34.5 x 4.3	250	5	1.50		\$414		
Z48BEC	12.2 x 22.5 x 4.3	250	5	1.50		\$379		

For use on Zira Media Tables, but can be used on any Zira Boardroom table of corresponding width. Acts as a “cap” at the upper part of a base to hide any wire or power block that may be visible to users. Available in Black or Silver finish.

Required Specifications

Top finish
Top/edge detail
Base finish
Base trim finish

Optional Specifications

HP laminate
Additional grommet

Accessories

Power block

COLLABORATIVE TABLES

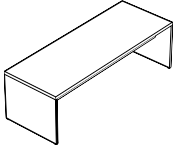

Collaborative Table - 29" H

MODEL#	DIMENSIONS D x W x H (1.5" TOP)	FREIGHT CLASS	WT/LBS.	CUBIC FT.	1" TOP	1.5" TOP	GLAZE ADD	HP ADD
Z367229BT	36 x 72 x 30	70	237	12.93	N/A	\$1474	N/A	\$531
Z368429BT	36 x 84 x 30	70	237	14.70	N/A	\$1715	N/A	\$621
Z369629BT	36 x 96 x 30	70	289	16.44	N/A	\$1858	N/A	\$709

Collaborative table with full end panels. Wire management runners span the length of the table between end panels. Shipped in 3 cartons.

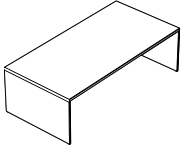

Collaborative Table - 29" H

Z487229BT	48 x 72 x 30	70	302	13.95	N/A	\$1853	N/A	\$709
Z488429BT	48 x 84 x 30	70	335	15.69	N/A	\$1996	N/A	\$827
Z489629BT	48 x 96 x 30	70	360	17.43	N/A	\$2157	N/A	\$944

Collaborative table with full end panels. Wire management runners span the length of the table between end panels. Shipped in 3 cartons.

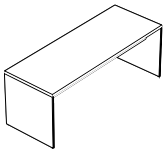

Collaborative Table - 36" H

Z367236BT	36 x 72 x 36.5	70	249	13.20	N/A	\$1529	N/A	\$531
Z368436BT	36 x 84 x 36.5	70	275	14.94	N/A	\$1775	N/A	\$621
Z369636BT	36 x 96 x 36.5	70	301	16.68	N/A	\$1917	N/A	\$709

Collaborative table with full end panels. Wire management runners span the length of the table between end panels. Shipped in 3 cartons.

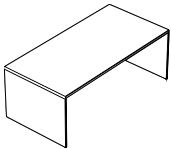

Collaborative Table - 36" H

Z487236BT	48 x 72 x 36.5	70	319	14.43	N/A	\$1922	N/A	\$709
Z488436BT	48 x 84 x 36.5	70	351	16.20	N/A	\$2070	N/A	\$827
Z489636BT	48 x 96 x 36.5	70	376	17.93	N/A	\$2231	N/A	\$944

Collaborative table with full end panels. Wire management runners span the length of the table between end panels. Shipped in 3 cartons.

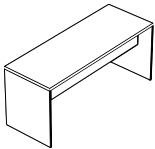

Collaborative Table - 42" H

Z367242BT	36 x 72 x 42.5	70	283	14.19	N/A	\$1711	N/A	\$531
Z368442BT	36 x 84 x 42.5	70	312	15.93	N/A	\$1976	N/A	\$621
Z369642BT	36 x 96 x 42.5	70	342	17.93	N/A	\$2138	N/A	\$709

Collaborative table with full end panels. Wire management runners span the length of the table between end panels. Shipped in 3 cartons.

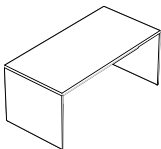

Collaborative Table - 42" H

Z487242BT	48 x 72 x 42.5	65	356	15.45	N/A	\$2118	N/A	\$709
Z488442BT	48 x 84 x 42.5	70	392	17.43	N/A	\$2281	N/A	\$827
Z489642BT	48 x 96 x 42.5	70	421	19.19	N/A	\$2467	N/A	\$944

Collaborative table with full end panels. Wire management runners span the length of the table between end panels. Shipped in 3 cartons.

Required Specifications

Top finish
Top/edge detail
Base finish
Base trim finish

Optional Specifications

HP laminate
Additional grommet

Accessories

Power block

ACCESSORIES

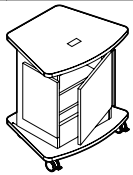

Multimedia Cart*

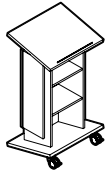

Lectern*

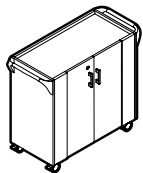

Serving Cart with Doors**

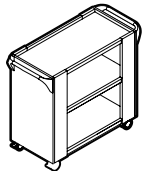

Serving Cart*

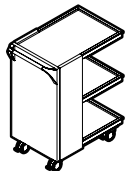

Buffet Cart*

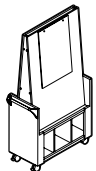

Visual Board*

MODEL#	DIMENSIONS D x W x H (1.5" TOP)	FREIGHT CLASS	WT/LBS.	CUBIC FT.	1" TOP	1.5" TOP	GLAZE ADD	HP ADD
Z2822MCE	22.25 x 28 x 29.5	125	86	13.50	\$697	\$751	N/A	\$137

Multimedia cart features one non-locking hinged door on the back. Includes 3 fixed shelves, 1 grommet on top and 1 grommet in bottom panel for wire pass thru. 4 locking casters included.

Z2444LEC	18 x 24 x 44.3	150	100	17	\$677	\$720	N/A	\$137
----------	----------------	-----	-----	----	--------------	--------------	-----	--------------

Features angled stand and storage with 2 fixed shelves. 2 locking casters included.

Z361836KD	18 x 36 x 36	125	150	20	\$1418	N/A	\$340	N/A
Z361829KD	18 x 36 x 29	125	113	16	\$1199	N/A	\$286	N/A

Cart features 2 doors with lock and 1 fixed height adjustable shelf. Top is recessed within side and end panels to act as a tray. Unique push handles are standard on both sides of the cart. 4 locking casters included.

Z361836KO	18 x 36 x 36	125	121	20	\$1537	N/A	N/A	N/A
Z361829KO	18 x 36 x 29	125	108	16	\$1286	N/A	N/A	N/A

Cart features 1 fixed height adjustable shelf. Top is recessed within side and end panels to act as a tray. Decorative aluminum trim is standard on the lip of each shelf. Unique push handles are standard on both sides of the cart. 4 locking casters included.

Z261836BK	18 x 26 x 36	150	79	15	\$1462	N/A	N/A	\$137
-----------	--------------	-----	----	----	---------------	-----	-----	--------------

Cart features 1 fixed shelf. Top is recessed within side and end panels to act as a tray. Unique push handles are standard. Decorative aluminum trim is standard on the lip of each shelf. Locking casters included. Height aligns with 36" buffets.

Z361872VB	18 x 36 x 72.4	100	187	19.25	\$2222	N/A	N/A	N/A
-----------	----------------	-----	-----	-------	---------------	-----	-----	-----

Angled visual board with paper pad on one side and dry erase board on the opposite side. Unique push handles are standard. Locking casters included. Decorative aluminum trim is standard on the lip of each shelf. Height aligns with 36" buffets. Shipped RTA (ready to assemble).

- *Wallmounted Visual Boards are available in Desk Accessories section.*

Required Specifications

Top finish Push bar finish**
 Base finish Handles
 Top/edge detail*
 Base trim finish (not Z3618xxKD)

Optional Specifications

HP laminate
 Glazed door (only Z3618xxKD)

BOARDROOM TABLES

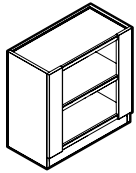

Buffet

MODEL#	DIMENSIONS D x W x H (1.5" TOP)	FREIGHT CLASS	WT/LBS.	CUBIC FT.	1" TOP	1.5" TOP	GLAZE ADD	HP ADD
Z481836BO	18 x 48 x 36	125	152.50	22.50	\$1352	N/A	N/A	\$183
Z481829BO	18 x 48 x 29	125	135	18	\$1248	N/A	N/A	\$183
Z361836BO	18 x 36 x 36	125	126	18	\$1115	N/A	N/A	\$137
Z361829BO	18 x 36 x 29	100	112	14	\$1025	N/A	N/A	\$137

Buffet features 1 fixed height adjustable shelf. Top is recessed within side and end panels to act as a tray. Decorative aluminum trim is standard on the lip of each shelf.

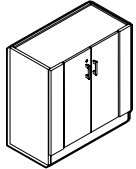

Buffet with Doors**

Z481836BD	18 x 48 x 36	125	171	22.50	\$1407	N/A	\$298	\$183
Z481829BD	18 x 48 x 29	100	148	18	\$1257	N/A	\$341	\$183
Z361836BD	18 x 36 x 36	125	138.50	18	\$1251	N/A	\$340	\$137
Z361829BD	18 x 36 x 29	100	119	14	\$1052	N/A	\$286	\$137

Buffet features 2 doors with lock and 1 fixed height adjustable shelf. Top is recessed within side and end panels to act as a tray.

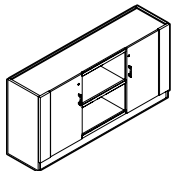

Buffet with Doors**

Z721836BU	18 x 72 x 36	125	242	33.50	\$2082	N/A	\$411	\$273
Z721829BU	18 x 72 x 29	125	211	27	\$1882	N/A	\$340	\$340
Z601836BU	18 x 60 x 36	125	188	28	\$1870	N/A	\$340	\$228
Z601829BU	18 x 60 x 29	125	163	22.50	\$1713	N/A	\$286	\$228

Buffet features 3 separate compartments. The two outer compartments come standard with locking doors and each features 1 fixed height adjustable shelf. The center compartment is open with 1 fixed height adjustable shelf. Decorative aluminum trim is standard on the lip of the open shelf. Top is recessed within side and end panels to act as a tray.

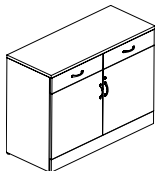

Buffet Credenza**

Z482036BD	20 x 48 x 36	100	199	24.70	\$1661	\$1756	\$716	\$311
-----------	--------------	-----	-----	-------	---------------	---------------	--------------	--------------

Buffet credenza with one locking storage compartment with two doors. Hinged doors cover one three-position height adjustable shelf. Two 6" drawers above storage compartment are non-locking.

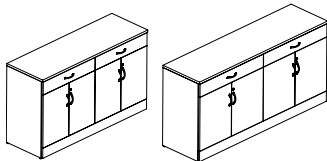

Buffet Credenza**

Z722036BD	20 x 72 x 36	125	265	36.50	\$2409	\$2525	\$1431	\$502
Z602036BD	20 x 60 x 36	125	228	30.75	\$2089	\$2195	\$1313	\$406

Buffet credenza with two locking storage compartments side by side. Hinged doors cover 1 three-position height adjustable shelf. Two 6" drawers above storage compartment are non-locking.

Required Specifications

Top finish Top/edge detail*
Base finish
Handles
Aluminum trim finish (only ZxxxxBO/BU)

Optional Specifications

HP laminate
Glazed door**

BOARDROOM TABLES MODEL# DIMENSIONS FREIGHT CLASS WT/LBS. CUBIC FT. 1" TOP 1.5" TOP GLAZE ADD HP ADD

D x W x H (1.5" TOP)

Interconnecting Cables - Common Cable Lengths (in inches)

Female/Female	42FF-86 \$145	42FM-41 \$107
42FF-27 \$89	42FF-97 \$166	42FM-50 \$116
42FF-38 \$99	42FF-98 \$166	42FM-63 \$128
42FF-41 \$102	42FF-100 \$158	42FM-75 \$140
42FF-50 \$111	42FF-110 \$169	42FM-82 \$146
42FF-53 \$114		42FM-86 \$150
42FF-63 \$123	Female/Male	42FM-97 \$166
42FF-75 \$134	42FM-12 \$79	42FM-98 \$166
42FF-76 \$135	42FM-27 \$93	42FM-100 \$178
42FF-82 \$142	42FM-38 \$103	42FM-110 \$178

VILLA DAISYLINK OR OASIS MINI CABLE LENGTHS NEEDED FOR DAISY-CHAINING

Model #	Villa DaisyLink, Oasis Mini USB Oasis Mini A Oasis Mini B	Villa DaisyLink, Oasis Mini USB Oasis Mini A Oasis Mini B	Oasis Mini USB Oasis Mini A	Oasis Mini USB Oasis Mini A	Villa DaisyLink or Oasis Mini B	Villa DaisyLink or Oasis Mini B
Cutout Positions	V1, V3, M1, M3	V1, V3, M1, M3	M1, M2 & M3	M1, M2 & M3	V1, V2, V3, M1, M2, M3	V1, V2, V3, M1, M2, M3
Infeed Position	Left or Right	Center	Left or Right	Center	Left or Right	Center
Reference	Drawing 1A/1B	Drawing 2A/2B	Drawing 3	Drawing 4	Drawing 5	Drawing 6
Z4896BE Z4896RTE Z4896REE Z4896BW	(1) 42FF-53 SPECIFY INFEED	(1) 42FF-27 (1) 42FM-27 (1) DAISY-T SPECIFY INFEED	N/A	N/A	N/A	N/A
Z48120BE Z48120RTE Z48120REE Z48120BW	(1) 42FF-76 SPECIFY INFEED	(1) 42FF-38 (1) 42FM-38 (1) DAISY-T SPECIFY INFEED	(3) 42FF-41 SPECIFY INFEED	(3) 42FF-41 SPECIFY INFEED	(2) 42FF-41 SPECIFY INFEED	(2) 42FF-41 (1) 42FM-12 (1) DAISY-T SPECIFY INFEED
Z48144BE Z48144RTE Z48144REE Z48144BW	(1) 42FF-100 SPECIFY INFEED	(1) 42FF-50 (1) 42FM-50 (1) DAISY-T SPECIFY INFEED	(3) 42FF-53 SPECIFY INFEED	(3) 42FF-53 SPECIFY INFEED	(2) 42FF-53 SPECIFY INFEED	(2) 42FF-53 (1) 42FM-12 (1) DAISY-T SPECIFY INFEED
Z48168BE Z48168RTE Z48168REE Z48168BW	(1) 42FF-63 (1) 42FM-63 SPECIFY INFEED	1) 42FF-63 (1) 42FM-63 (1) DAISY-T SPECIFY INFEED	(3) 42FF-65 SPECIFY INFEED	(3) 42FF-65 SPECIFY INFEED	(2) 42FF-65 SPECIFY INFEED	(2) 42FF-65 (1) 42FM-12 (1) DAISY-T SPECIFY INFEED
Z48192BE Z48192RTE Z48192REE Z48192BW	(1) 42FF-75 (1) 42FM-75 SPECIFY INFEED	1) 42FF-75 (1) 42FM-75 (1) DAISY-T SPECIFY INFEED	(3) 42FF-77 SPECIFY INFEED	(3) 42FF-77 SPECIFY INFEED	(2) 42FF-77 SPECIFY INFEED	(2) 42FF-77 (1) 42FM-12 (1) DAISY-T SPECIFY INFEED
Z48216BE Z48216RTE Z48216REE Z48216BW	(1) 42FF-86 (1) 42FM-86 SPECIFY INFEED	1) 42FF-85 (1) 42FM-85 (1) DAISY-T SPECIFY INFEED	(3) 42FF-89 SPECIFY INFEED	(3) 42FF-89 SPECIFY INFEED	(2) 42FF-89 SPECIFY INFEED	(2) 42FF-89 (1) 42FM-12 (1) DAISY-T SPECIFY INFEED
Z48240BE Z48240RTE Z48240REE Z48240BW	(1) 42FF-98 (1) 42FM-98 SPECIFY INFEED	1) 42FF-97 (1) 42FM-97 (1) DAISY-T SPECIFY INFEED	(3) 42FF-101 SPECIFY INFEED	(3) 42FF-101 SPECIFY INFEED	(2) 42FF-101 SPECIFY INFEED	(2) 42FF-101 (1) 42FM-12 (1) DAISY-T SPECIFY INFEED

Model #	Villa DaisyLink, Oasis Mini USB Oasis Mini A Oasis Mini B	Villa DaisyLink, Oasis Mini USB Oasis Mini A Oasis Mini B	Oasis Mini USB Oasis Mini A	Oasis Mini USB Oasis Mini A	Villa DaisyLink or Oasis Mini B	Villa DaisyLink or Oasis Mini B
Z48264BE Z48264RTE Z48264REE Z48264BW	(1) 42FF-110 (1) 42FM-110 SPECIFY INFEED	(1) 42FF-110 (1) 42FM-110 (1) DAISY-T SPECIFY INFEED	(3) 42FF-113 SPECIFY INFEED	(3) 42FF-113 SPECIFY INFEED	(2) 42FF-113 SPECIFY INFEED	(2) 42FF-113 (1) 42FM-12 (1) DAISY-T SPECIFY INFEED
Z48288BE Z48288RTE Z48288REE Z48288BW	(1) 42FF-82 (2) 42FM-82 SPECIFY INFEED	(2) 42FF-41 (2) 42FM-41 (1) DAISY-T SPECIFY INFEED	(3) 42FF-63 (3) 42FM-63 SPECIFY INFEED	(3) 42FF-63 (3) 42FM-63 SPECIFY INFEED	(2) 42FF-63 (2) 42FM-63 SPECIFY INFEED	(2) 42FF-63 (2) 42FM-63 (1) DAISY-T SPECIFY INFEED

RECEPTION DESKS AND RETURNS

- Offered with **Straight** and **Bow** front
- Transactional tops available in 1" or 1/2" thick top with a variety of edge details
- Worksurface available in 1" thickness with A3 edge only

TOP AND BASE FINISHES

ACJ Absolute Acajou	HGT Hayden Grey
ASN Asian Night	QTM Quartered Mahogany
AWC Avant Cherry	SOG Storm Grey
AWH Avant Honey	TFW Tiger Fruitwood
BLK Black	TWL Tiger Walnut
BRC Brushed Cobalt	WHE Walnut Heights
CMB Clear Maple	WHC White Chocolate
DES Dark Espresso	WCR Winter Cherry
DWT Designer White	WGY Willow Grey

Reception Desks:

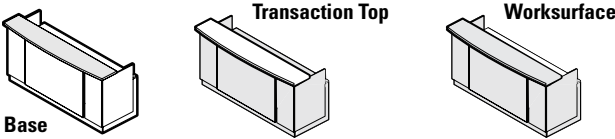

Reception Returns:

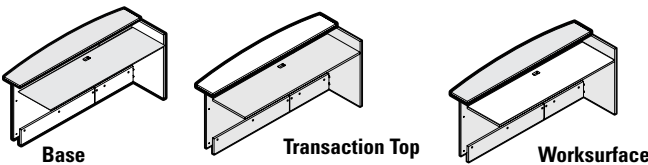

TRANSACTION TOP THICKNESS/EDGE DETAIL

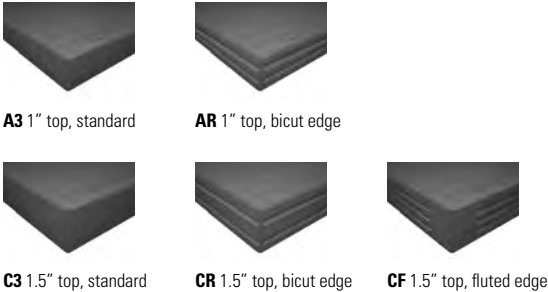

GLAZING (Center Panels)

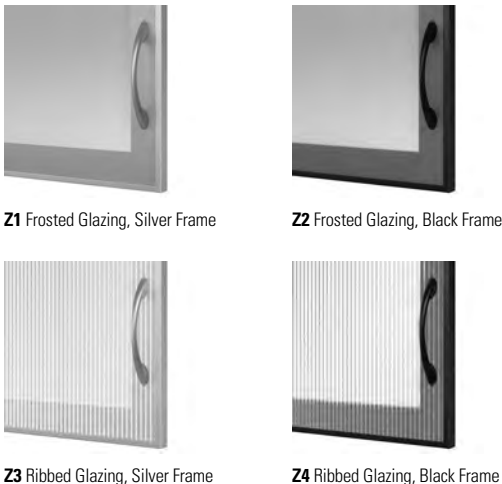

GROMMETS - RECEPTION DESKS ONLY

- Two grommets are standard in position **AG1** and **AG3**
- Standard grommets can be removed at an upcharge
- Optional grommets available in **AG2**

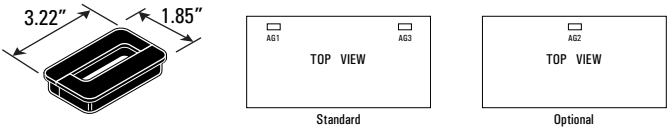

- Grommet hole dimensions are 3 1/4" wide x 1 7/8" deep.

POWER BLOCK

- A Power Block (model **PMSPDM**) may be ordered on transaction tops.
- A Power Block is a rectangular worksurface power/data module with one electrical duplex receptacle and two data (RJ45) receptacles. 9 foot black cord included. Power Block dimensions are 3 1/2" deep x 6 1/2" wide x 2 3/4" high.
- To purchase a Power Block, you must specify both the Power Block cut-out location and the Power Block model #. Order Power Block as **PMSPDM**, Add **\$261**. Power Blocks are available in standard worksurface locations (left, center or right). Order as **E1, E2 or E3**. ADD **\$69**.



Power Block **PMSPDM** Add **\$261** Specify location **E1, E2 or E3** Add **\$69**

TASK LIGHT

- Illuminates worksurface and optional glazed center panel
- Specify LED task light separately. Use PLED50 for 60", 66" and 72" wide reception units. Use PLED50 or PLED100 for 84" and 96" wide units. See page 530 for details.

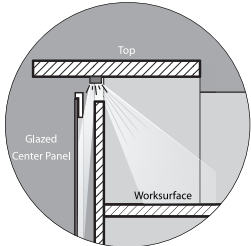

RECEPTION RETURNS - PIGEON

- Available in all laminates
- Worksurface available in 1" thickness with A3 edge only
- Collator shelves offered in Black (BLK) or Brushed Cobalt (BRC)
- One grommet is standard in position **AG3**
- Standard grommet can be removed at an upcharge
- Optional grommet available in position **AG2**, see upcharges above
- Power blocks are available in positions **E2 and E3**

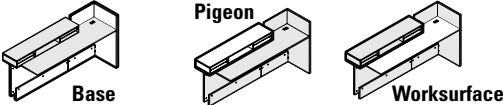

RECEPTION RETURNS - BOOKCASE

- Available in all laminates listed above
- Worksurface available in 1" thickness with A3 edge only
- One grommet is standard in position **AG2**
- Standard grommet can be removed at an upcharge
- Optional grommet available in position **AG3** for **54", 60" and 72" wide units only**
- Power blocks are available in positions **E2 and E3** for **54", 60" and 72" wide units only**

RECEPTION DESKS

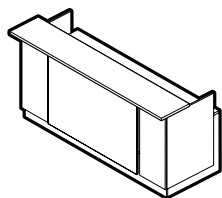

Reception Desk

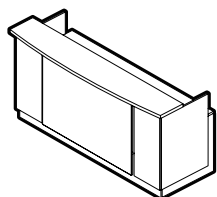

Reception Desk - Bow Front

MODEL#	DIMENSIONS D x W x H (1.5" TOP)	FREIGHT CLASS	WT/LBS.	CUBIC FT.	1" TOP	1.5" TOP	GLAZE ADD	HP ADD
Z3096RDS	35.5 x 96 x 43.3	70	385	23.23	\$2693	\$2843	\$562	\$636
Z3084RDS	35.5 x 89.4 x 43.3	70	351	20.48	\$2394	\$2528	\$485	\$557
Z3072RDS	35.5 x 77.4 x 43.3	70	315	17.99	\$2208	\$2323	\$406	\$477
Z3066RDS	35.5 x 71.4 x 43.3	70	298	16.98	\$2096	\$2208	\$367	\$438
Z3060RDS	35.5 x 65.4 x 43.3	70	280	15.48	\$1999	\$2101	\$328	\$398
Z2496RDS	30 x 96 x 43.3	70	353	21.98	\$2540	\$2690	\$562	\$545
Z2484RDS	30 x 89.4 x 43.3	70	320	19.49	\$2263	\$2397	\$485	\$477
Z2472RDS	30 x 77.4 x 43.3	70	287	16.98	\$2083	\$2202	\$406	\$409
Z2466RDS	30 x 71.4 x 43.3	70	272	15.99	\$1974	\$2086	\$367	\$375
Z2460RDS	30 x 65.4 x 43.3	70	256	15	\$1881	\$1983	\$328	\$341

Z24xxRDS units are not freestanding; they must be connected to a return. Z30xxRDS units can be specified as freestanding. Standard with two grommets. Accommodates shells of all depths. Shipped RTA (ready to assemble) in 3 cartons.

- **Zxx96RDS** units feature a 90" w worksurface

Z3096RDB	35.5 x 96 x 43.3	70	382	23.23	\$2693	\$2843	\$562	\$636
Z3084RDB	35.5 x 89.4 x 43.3	70	348	20.48	\$2394	\$2528	\$485	\$557
Z3072RDB	35.5 x 77.4 x 43.3	70	312	17.99	\$2208	\$2323	\$406	\$477
Z3066RDB	35.5 x 71.4 x 43.3	70	295	16.98	\$2096	\$2208	\$367	\$438
Z3060RDB	35.5 x 65.4 x 43.3	70	277	15.99	\$1999	\$2101	\$328	\$398
Z2496RDB	30 x 96 x 43.3	70	350	21.98	\$2540	\$2674	\$562	\$545
Z2484RDB	30 x 89.4 x 43.3	70	317	19.49	\$2263	\$2397	\$485	\$477
Z2472RDB	30 x 77.4 x 43.3	70	284	16.98	\$2083	\$2202	\$406	\$409
Z2466RDB	30 x 71.4 x 43.3	70	269	15.99	\$1974	\$2086	\$367	\$375
Z2460RDB	30 x 65.4 x 43.3	70	253	15	\$1881	\$1983	\$328	\$341

Z24xxRDB units are not freestanding; they must be connected to a return. Z30xxRDB units can be specified as freestanding. Standard with two grommets. Accommodates shells of all depths. Shipped RTA (ready to assemble) in 3 cartons.

- **Zxx96RDB** units feature a 90" w worksurface

Required Specifications

Top finish
Top/edge detail
Base/surround finish
Transaction top finish

Optional Specifications

HP laminate
Additional grommet

Accessories

Power block

HIGH RECEPTION RETURNS

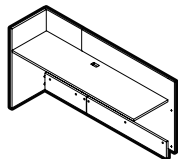

High Reception Return - LEFT

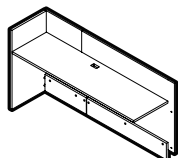

High Reception Return - LEFT

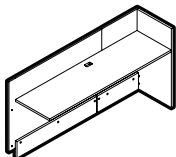

High Reception Return - RIGHT

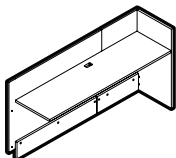

High Reception Return - RIGHT

MODEL#	DIMENSIONS D x W x H	FREIGHT CLASS	WT/LBS.	CUBIC FT.	1" TOP	1.5" TOP	GLAZE ADD	HP ADD
Z2472HRRL	25 x 75.7 x 40.3	70	151	8.20	\$1006	N/A	N/A	\$273
Z2460HRRL	25 x 63.7 x 40.3	70	131.20	7	\$880	N/A	N/A	\$228
Z2454HRRL	25 x 57.7 x 40.3	70	120.90	5.75	\$799	N/A	N/A	\$205
Z2448HRRL	25 x 51.7 x 40.3	70	110.90	5.25	\$741	N/A	N/A	\$183
Z2442HRRL	25 x 45.7 x 40.3	70	100.80	4.80	\$683	N/A	N/A	\$160
Z2436HRRL	25 x 39.7 x 40.3	70	90.70	4.30	\$625	N/A	N/A	\$137

Not freestanding. Grommet in worksurface. Shipped RTA (ready to assemble). Accommodates shells of all depths. Connecting hardware included. Widths and depths listed are outside dimensions including outside surrounds. Model numbers reflect the primary worksurface dimensions.

Z2072HRRL	20.9 x 75.7 x 40.3	70	139	8.20	\$888	N/A	N/A	\$228
Z2060HRRL	20.9 x 63.7 x 40.3	70	121	7	\$774	N/A	N/A	\$191
Z2054HRRL	20.9 x 57.7 x 40.3	70	111	5.75	\$698	N/A	N/A	\$171
Z2048HRRL	20.9 x 51.7 x 40.3	70	102	5.25	\$648	N/A	N/A	\$153
Z2042HRRL	20.9 x 45.7 x 40.3	70	92	4.80	\$595	N/A	N/A	\$133
Z2036HRRL	20.9 x 39.7 x 40.3	70	83	4.30	\$542	N/A	N/A	\$115

Not freestanding. Grommet in worksurface. Shipped RTA (ready to assemble). Accommodates shells of 20" depths. Connecting hardware included. Widths and depths listed are outside dimensions including outside surrounds. Model numbers reflect the primary worksurface dimensions.

Z2472HRRR	25 x 75.7 x 40.3	70	151	8.20	\$1006	N/A	N/A	\$273
Z2460HRRR	25 x 63.7 x 40.3	70	131.20	7	\$880	N/A	N/A	\$228
Z2454HRRR	25 x 57.7 x 40.3	70	120.90	5.75	\$799	N/A	N/A	\$205
Z2448HRRR	25 x 51.7 x 40.3	70	110.90	5.25	\$741	N/A	N/A	\$183
Z2442HRRR	25 x 45.7 x 40.3	70	100.80	4.80	\$683	N/A	N/A	\$160
Z2436HRRR	25 x 39.7 x 40.3	70	90.70	4.30	\$625	N/A	N/A	\$137

Not freestanding. Grommet in worksurface. Shipped RTA (ready to assemble). Accommodates shells of all depths. Connecting hardware included. Widths and depths listed are outside dimensions including outside surrounds. Model numbers reflect the primary worksurface dimensions.

Z2072HRRR	20.9 x 75.7 x 40.3	70	139	8.20	\$888	N/A	N/A	\$228
Z2060HRRR	20.9 x 63.7 x 40.3	70	121	7	\$774	N/A	N/A	\$191
Z2054HRRR	20.9 x 57.7 x 40.3	70	111	5.75	\$698	N/A	N/A	\$171
Z2048HRRR	20.9 x 51.7 x 40.3	70	102	5.25	\$648	N/A	N/A	\$153
Z2042HRRR	20.9 x 45.7 x 40.3	70	92	4.80	\$595	N/A	N/A	\$133
Z2036HRRR	20.9 x 39.7 x 40.3	70	83	4.30	\$542	N/A	N/A	\$115

Not freestanding. Grommet in worksurface. Shipped RTA (ready to assemble). Accommodates shells of 20" depths. Connecting hardware included. Widths and depths listed are outside dimensions including outside surrounds. Model numbers reflect the primary worksurface dimensions.

Required Specifications

Top finish
Top/edge detail
Base/surround finish

Optional Specifications

HP laminate
Additional grommet

Accessories

Power block

LOW RECEPTION RETURNS

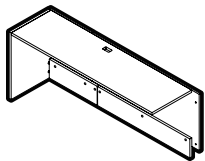

Low Reception Return - LEFT

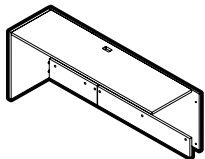

Low Reception Return - LEFT

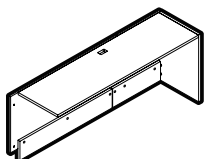

Low Reception Return - RIGHT

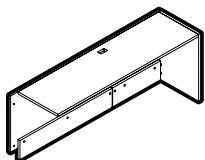

Low Reception Return - RIGHT

MODEL#	DIMENSIONS D x W x H	FREIGHT CLASS	WT/LBS.	CUBIC FT.	1" TOP	1.5" TOP	GLAZE ADD	HP ADD
Z2472LRRL	25 x 75.7 x 29.6	70	141	6.75	\$978	N/A	N/A	\$273
Z2460LRRL	25 x 63.7 x 29.6	70	122	5.75	\$844	N/A	N/A	\$228
Z2454LRRL	25 x 57.7 x 29.6	70	112.90	5.50	\$773	N/A	N/A	\$205
Z2448LRRL	25 x 51.7 x 29.6	70	103.40	5	\$717	N/A	N/A	\$183
Z2442LRRL	25 x 45.7 x 29.6	70	94	4.50	\$659	N/A	N/A	\$160
Z2436LRRL	25 x 39.7 x 29.6	70	84.30	4	\$600	N/A	N/A	\$137

Not freestanding. Grommet in worksurface. Shipped RTA (ready to assemble). Accommodates shells of all depths. Connecting hardware included. Widths and depths listed are outside dimensions including outside surrounds. Model numbers reflect the primary worksurface dimensions.

Z2072LRRL	20.9 x 75.7 x 29.6	70	128.80	6.75	\$861	N/A	N/A	\$228
Z2060LRRL	20.9 x 63.7 x 29.6	70	111.30	5.75	\$739	N/A	N/A	\$191
Z2054LRRL	20.9 x 57.7 x 29.6	70	102.80	5.50	\$675	N/A	N/A	\$171
Z2048LRRL	20.9 x 51.7 x 29.6	70	94.10	5	\$625	N/A	N/A	\$153
Z2042LRRL	20.9 x 45.7 x 29.6	70	85.30	4.50	\$573	N/A	N/A	\$133
Z2036LRRL	20.9 x 39.7 x 29.6	70	76.30	4	\$521	N/A	N/A	\$115

Not freestanding. Grommet in worksurface. Shipped RTA (ready to assemble). Accommodates shells of 20" depths. Connecting hardware included. Widths and depths listed are outside dimensions including outside surrounds. Model numbers reflect the primary worksurface dimensions.

Z2472LRRR	25 x 75.7 x 29.6	70	141	6.75	\$978	N/A	N/A	\$273
Z2460LRRR	25 x 63.7 x 29.6	70	122	5.75	\$844	N/A	N/A	\$228
Z2454LRRR	25 x 57.7 x 29.6	70	112.90	5.50	\$773	N/A	N/A	\$205
Z2448LRRR	25 x 51.7 x 29.6	70	103.40	5	\$717	N/A	N/A	\$183
Z2442LRRR	25 x 45.7 x 29.6	70	94	4.50	\$659	N/A	N/A	\$160
Z2436LRRR	25 x 39.7 x 29.6	70	84.30	4	\$600	N/A	N/A	\$137

Not freestanding. Grommet in worksurface. Shipped RTA (ready to assemble). Accommodates shells of all depths. Connecting hardware included. Widths and depths listed are outside dimensions including outside surrounds. Model numbers reflect the primary worksurface dimensions.

Z2072LRRR	20.9 x 75.7 x 29.6	70	128.80	6.75	\$861	N/A	N/A	\$228
Z2060LRRR	20.9 x 63.7 x 29.6	70	111.30	5.75	\$739	N/A	N/A	\$191
Z2054LRRR	20.9 x 57.7 x 29.6	70	102.80	5.50	\$675	N/A	N/A	\$171
Z2048LRRR	20.9 x 51.7 x 29.6	70	94.10	5	\$625	N/A	N/A	\$153
Z2042LRRR	20.9 x 45.7 x 29.6	70	85.30	4.50	\$573	N/A	N/A	\$133
Z2036LRRR	20.9 x 39.7 x 29.6	70	76.30	4	\$521	N/A	N/A	\$115

Not freestanding. Grommet in worksurface. Shipped RTA (ready to assemble). Accommodates shells of 20" depths. Connecting hardware included. Widths and depths listed are outside dimensions including outside surrounds. Model numbers reflect the primary worksurface dimensions.

Required Specifications

Top finish
Top/edge detail
Base/surround finish

Optional Specifications

HP laminate
Additional grommet

Accessories

Power block

TRANSACTIONAL RETURNS

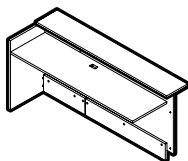

Transactional Return - LEFT

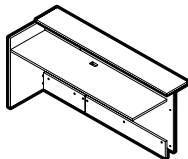

Transactional Return - LEFT

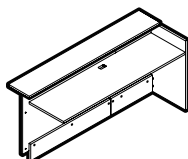

Transactional Return - RIGHT

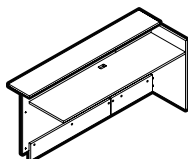

Transactional Return - RIGHT

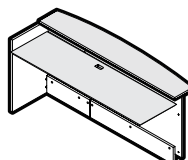

Transactional Return, Bow Front - LEFT

MODEL#	DIMENSIONS D x W x H (1.5" TOP)	FREIGHT CLASS	WT/LBS.	CUBIC FT.	1" TOP	1.5" TOP	GLAZE ADD	HP ADD
Z2472TSRL	29.7 x 75.7 x 37.5	70	166	9.75	\$1198	\$1291	N/A	\$273
Z2460TSRL	29.7 x 63.7 x 37.5	70	144	8.75	\$1034	\$1114	N/A	\$228
Z2454TSRL	29.7 x 57.7 x 37.5	70	132	7.50	\$939	\$1013	N/A	\$205
Z2448TSRL	29.7 x 51.7 x 37.5	70	121	7	\$863	\$928	N/A	\$183
Z2442TSRL	29.7 x 45.7 x 37.5	70	109	6.25	\$792	\$851	N/A	\$160
Z2436TSRL	29.7 x 39.7 x 37.5	70	96	5.50	\$718	\$770	N/A	\$137

Not freestanding. Grommet in worksurface. Shipped RTA (ready to assemble). Accommodates shells of all depths. Connecting hardware included. Widths and depths listed are outside dimensions including transaction top overhang on the front and sides. Model numbers reflect the primary worksurface dimensions.

Z2072TSRL	25.6 x 75.7 x 37.5	70	153	8.25	\$1077	\$1170	N/A	\$228
Z2060TSRL	25.6 x 63.7 x 37.5	70	132	7.25	\$925	\$1005	N/A	\$191
Z2054TSRL	25.6 x 57.7 x 37.5	70	120	6.25	\$837	\$911	N/A	\$171
Z2048TSRL	25.6 x 51.7 x 37.5	70	110	5.50	\$768	\$833	N/A	\$153
Z2042TSRL	25.6 x 45.7 x 37.5	70	100	5	\$700	\$759	N/A	\$133
Z2036TSRL	25.6 x 39.7 x 37.5	70	89	4.40	\$635	\$687	N/A	\$115

Not freestanding. Grommet in worksurface. Shipped RTA (ready to assemble). Accommodates shells of 20" depths. Connecting hardware included. Widths and depths listed are outside dimensions including transaction top overhang on the front and sides. Model numbers reflect the primary worksurface dimensions.

Z2472TSRR	29.7 x 75.7 x 37.5	70	166	9.75	\$1198	\$1291	N/A	\$273
Z2460TSRR	29.7 x 63.7 x 37.5	70	144	8.75	\$1034	\$1114	N/A	\$228
Z2454TSRR	29.7 x 57.7 x 37.5	70	132	7.50	\$939	\$1013	N/A	\$205
Z2448TSRR	29.7 x 51.7 x 37.5	70	121	7	\$863	\$928	N/A	\$183
Z2442TSRR	29.7 x 45.7 x 37.5	70	109	6.25	\$792	\$851	N/A	\$160
Z2436TSRR	29.7 x 39.7 x 37.5	70	96	5.50	\$718	\$770	N/A	\$137

Not freestanding. Grommet in worksurface. Shipped RTA (ready to assemble). Accommodates shells of all depths. Connecting hardware included. Widths and depths listed are outside dimensions including transaction top overhang on the front and sides. Model numbers reflect the primary worksurface dimensions.

Z2072TSRR	25.6 x 75.7 x 37.5	70	153	8.25	\$1077	\$1170	N/A	\$228
Z2060TSRR	25.6 x 63.7 x 37.5	70	132	7.25	\$925	\$1005	N/A	\$191
Z2054TSRR	25.6 x 57.7 x 37.5	70	120	6.25	\$837	\$911	N/A	\$171
Z2048TSRR	25.6 x 51.7 x 37.5	70	110	5.50	\$768	\$833	N/A	\$153
Z2042TSRR	25.6 x 45.7 x 37.5	70	100	5	\$700	\$759	N/A	\$133
Z2036TSRR	25.6 x 39.7 x 37.5	70	89	4.40	\$635	\$687	N/A	\$115

Not freestanding. Grommet in worksurface. Shipped RTA (ready to assemble). Accommodates shells of 20" depths. Connecting hardware included. Widths and depths listed are outside dimensions including transaction top overhang on the front and sides. Model numbers reflect the primary worksurface dimensions.

Z2472TBRL	32.7 x 75.7 x 37.5	70	168.20	9.75	\$1198	\$1291	N/A	\$273
Z2460TBRL	32.7 x 63.7 x 37.5	70	145.30	8.50	\$1034	\$1114	N/A	\$228
Z2454TBRL	32.7 x 57.7 x 37.5	70	134.40	7.50	\$939	\$1013	N/A	\$205
Z2448TBRL	32.7 x 51.7 x 37.5	70	122.20	7	\$863	\$928	N/A	\$183
Z2442TBRL	32.7 x 45.7 x 37.5	70	110.90	6.25	\$792	\$851	N/A	\$160
Z2436TBRL	32.7 x 39.7 x 37.5	70	98.40	5.50	\$718	\$770	N/A	\$137

Not freestanding. Grommet in worksurface. Shipped RTA (ready to assemble). Accommodates shells of all depths. Connecting hardware included. Widths and depths listed are outside dimensions including transaction top overhang on the front and sides. Model numbers reflect the primary worksurface dimensions.

Required Specifications

Top finish
Base/surround finish
Transaction top finish

Optional Specifications

HP laminate
Additional grommet

Accessories

Power block

TRANSACTIONAL RETURNS

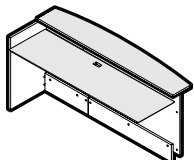

Transactional Return, Bow Front - LEFT

MODEL#	DIMENSIONS D x W x H (1.5" TOP)	FREIGHT CLASS	WT/LBS.	CUBIC FT.	1" TOP	1.5" TOP	GLAZE ADD	HP ADD
Z2072TBRL	28.6 x 75.7 x 37.5	70	155.60	8.25	\$1077	\$1170	N/A	\$228
Z2060TBRL	28.6 x 63.7 x 37.5	70	134.20	7.50	\$925	\$1005	N/A	\$191
Z2054TBRL	28.6 x 57.7 x 37.5	70	124	6.50	\$837	\$911	N/A	\$171
Z2048TBRL	28.6 x 51.7 x 37.5	70	112.60	6	\$768	\$833	N/A	\$153
Z2042TBRL	28.6 x 45.7 x 37.5	70	101.90	5.25	\$700	\$759	N/A	\$133
Z2036TBRL	28.6 x 39.7 x 37.5	70	90.10	4.70	\$635	\$687	N/A	\$115

Not freestanding. Grommet in worksurface. Shipped RTA (ready to assemble). Accommodates shells of **20" depths**. Connecting hardware included. Widths and depths listed are outside dimensions including transaction top overhang on the front and sides. Model numbers reflect the primary worksurface dimensions.

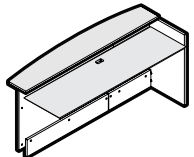

Transactional Return, Bow Front - RIGHT

Z2472TBRR	32.7 x 75.7 x 37.5	70	168.20	9.75	\$1198	\$1291	N/A	\$273
Z2460TBRR	32.7 x 63.7 x 37.5	70	145.30	8.50	\$1034	\$1114	N/A	\$228
Z2454TBRR	32.7 x 57.7 x 37.5	70	134.40	7.50	\$939	\$1013	N/A	\$205
Z2448TBRR	32.7 x 51.7 x 37.5	70	122.20	7	\$863	\$928	N/A	\$183
Z2442TBRR	32.7 x 45.7 x 37.5	70	110.90	6.25	\$792	\$851	N/A	\$160
Z2436TBRR	32.7 x 39.7 x 37.5	70	98.40	5.50	\$718	\$770	N/A	\$137

Not freestanding. Grommet in worksurface. Shipped RTA (ready to assemble). Accommodates shells of all depths. Connecting hardware included. Widths and depths listed are outside dimensions including transaction top overhang on the front and sides. Model numbers reflect the primary worksurface dimensions.

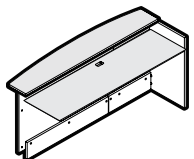

Transactional Return, Bow Front - RIGHT

Z2072TBRR	28.6 x 75.7 x 37.5	70	155.60	8.25	\$1077	\$1170	N/A	\$228
Z2060TBRR	28.6 x 63.7 x 37.5	70	134.20	7.50	\$925	\$1005	N/A	\$191
Z2054TBRR	28.6 x 57.7 x 37.5	70	124	6.50	\$837	\$911	N/A	\$171
Z2048TBRR	28.6 x 51.7 x 37.5	70	112.60	6	\$768	\$833	N/A	\$153
Z2042TBRR	28.6 x 45.7 x 37.5	70	101.90	5.25	\$700	\$759	N/A	\$133
Z2036TBRR	28.6 x 39.7 x 37.5	70	90.10	4.70	\$635	\$687	N/A	\$115

Not freestanding. Grommet in worksurface. Shipped RTA (ready to assemble). Accommodates shells of **20" depths**. Connecting hardware included. Widths and depths listed are outside dimensions including transaction top overhang on the front and sides. Model numbers reflect the primary worksurface dimensions.

Required Specifications

Top finish
Transaction top finish
Base/surround finish

Optional Specifications

HP laminate
Additional grommet

Accessories

Power block

PIGEON RECEPTION RETURNS

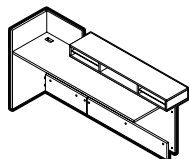

Pigeon Reception Return - LEFT*

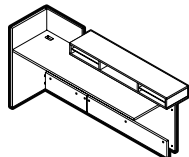

Pigeon Reception Return - LEFT*

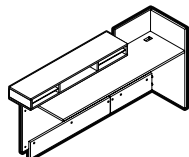

Pigeon Reception Return - RIGHT*

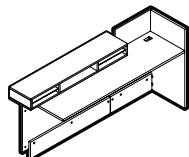

Pigeon Reception Return - RIGHT*

MODEL#	DIMENSIONS D x W x H	FREIGHT CLASS	WT/LBS.	CUBIC FT.	1" TOP	1.5" TOP	GLAZE ADD	HP ADD
Z2472PRRL	31 x 75.7 x 40.3	70	171.30	9.75	\$1357	N/A	N/A	\$273
Z2460PRRL	31 x 63.7 x 40.3	70	149	8.25	\$1192	N/A	N/A	\$228
Z2454PRRL	31 x 57.7 x 40.3	70	136.40	7.50	\$1109	N/A	N/A	\$205

Not freestanding. Grommet in worksurface. Shipped RTA (ready to assemble). Accommodates shells of all depths. Connecting hardware included. Widths and depths listed are outside dimensions including transaction top overhang on the front and sides. Model numbers reflect the primary worksurface dimensions.

Z2072PRRL	26.9 x 75.7 x 40.3	70	159	9.75	\$1240	N/A	N/A	\$228
Z2060PRRL	26.9 x 63.7 x 40.3	70	138.20	8.25	\$1086	N/A	N/A	\$191
Z2054PRRL	26.9 x 57.7 x 40.3	70	126.20	7.50	\$1008	N/A	N/A	\$171

Not freestanding. Grommet in worksurface. Shipped RTA (ready to assemble). Accommodates shells of 20" depths. Connecting hardware included. Widths and depths listed are outside dimensions including transaction top overhang on the front and sides. Model numbers reflect the primary worksurface dimensions.

Z2472PRRR	31 x 75.7 x 40.3	70	171.30	9.75	\$1357	N/A	N/A	\$273
Z2460PRRR	31 x 63.7 x 40.3	70	149	8.25	\$1192	N/A	N/A	\$228
Z2454PRRR	31 x 57.7 x 40.3	70	136.40	7.50	\$1109	N/A	N/A	\$205

Not freestanding. Grommet in worksurface. Shipped RTA (ready to assemble). Accommodates shells of all depths. Connecting hardware included. Widths and depths listed are outside dimensions including transaction top overhang on the front and sides. Model numbers reflect the primary worksurface dimensions.

Z2072PRRR	26.9 x 75.7 x 40.3	70	159	9.75	\$1240	N/A	N/A	\$228
Z2060PRRR	26.9 x 63.7 x 40.3	70	138.20	8.25	\$1086	N/A	N/A	\$191
Z2054PRRR	26.9 x 57.7 x 40.3	70	126.20	7.50	\$1008	N/A	N/A	\$171

Not freestanding. Grommet in worksurface. Shipped RTA (ready to assemble). Accommodates shells of 20" depths. Connecting hardware included. Widths and depths listed are outside dimensions including transaction top overhang on the front and sides. Model numbers reflect the primary worksurface dimensions.

Required Specifications

Top finish
Base/surround finish
Pigeon hole finish
Collator finish

Optional Specifications

HP laminate
Additional grommet

Accessories

Power block

BOOKCASE RETURNS

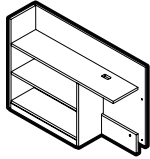

Bookcase Reception Return - LEFT

MODEL#	DIMENSIONS D x W x H	FREIGHT CLASS	WT/LBS.	CUBIC FT.	1" TOP	1.5" TOP	GLAZE ADD	HP ADD
Z1272BRRL	13.7 x 75.7 x 40.3	70	158	7.50	\$1085	N/A	N/A	\$137
Z1260BRRL	13.7 x 63.7 x 40.3	70	139	6.25	\$959	N/A	N/A	\$115

Not freestanding. Grommet in worksurface. Shipped RTA (ready to assemble). Accommodates shells of all depths. Connecting hardware included. Widths and depths listed are outside dimensions including outside surrounds. Model numbers reflect the primary worksurface dimensions.

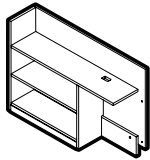

Bookcase Reception Return - LEFT

Z1254BRRL	13.7 x 57.7 x 40.3	65	131	5.75	\$888	N/A	N/A	\$103
Z1248BRRL	13.7 x 51.7 x 40.3	70	114	5.25	\$789	N/A	N/A	\$92
Z1242BRRL	13.7 x 45.7 x 40.3	65	106	4.60	\$742	N/A	N/A	\$81
Z1236BRRL	13.7 x 39.7 x 40.3	65	98	4.10	\$695	N/A	N/A	\$70

Not freestanding. Grommet in worksurface. Shipped RTA (ready to assemble). Accommodates shells of all depths. Connecting hardware included. Widths and depths listed are outside dimensions including outside surrounds. Model numbers reflect the primary worksurface dimensions.

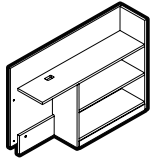

Bookcase Reception Return - RIGHT

Z1272BRRR	13.7 x 75.7 x 40.3	70	158	7.50	\$1085	N/A	N/A	\$137
Z1260BRRR	13.7 x 63.7 x 40.3	70	139	6.25	\$959	N/A	N/A	\$115

Not freestanding. Grommet in worksurface. Shipped RTA (ready to assemble). Accommodates shells of all depths. Connecting hardware included. Widths and depths listed are outside dimensions including outside surrounds. Model numbers reflect the primary worksurface dimensions.

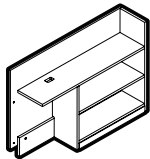

Bookcase Reception Return - RIGHT

Z1254BRRR	13.7 x 57.7 x 40.3	65	131	5.75	\$888	N/A	N/A	\$103
Z1248BRRR	13.7 x 51.7 x 40.3	70	114	5.25	\$789	N/A	N/A	\$92
Z1242BRRR	13.7 x 45.7 x 40.3	65	106	4.60	\$742	N/A	N/A	\$81
Z1236BRRR	13.7 x 39.7 x 40.3	65	98	4.10	\$695	N/A	N/A	\$70

Not freestanding. Grommet in worksurface. Shipped RTA (ready to assemble). Accommodates shells of all depths. Connecting hardware included. Widths and depths listed are outside dimensions including outside surrounds. Model numbers reflect the primary worksurface dimensions.

RECEPTION DESK VERTICAL STORAGE

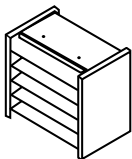

Reception Desk - Vertical Storage*

ZRDVS13	8.6 x 13.4 x 12.2	70	12.50	.80	\$177	N/A	N/A	N/A
---------	-------------------	----	-------	-----	--------------	-----	-----	-----

Collator shelves.

Required Specifications

Top finish
Base/surround finish
Pigeon hole finish*
Collator finish*

Optional Specifications

HP laminate
Additional grommet

Accessories

Power block

desking – metal



StreamLINE II

308



Global's **StreamLINE** series incorporates a rich laminate top with a sturdy steel body. This unique combination is great for heavy duty environments such as offices, schools, warehouses and factories.

Full-to-Floor Pedestals were designed to utilize all available space. Choose from Box/Box/File and File/File combinations as well as hanging pedestals. File drawers have high drawer sides for hanging folders and eliminate the need for file bars.

Models include Desks, Returns, Bridges, Credenzas, Hutches and Accessories such as a center drawer and optional keys for keying alike. This wide range of models, pedestal options and finish selections are sure to fit a variety of office and organizational needs.

Features and Benefits

- Tops are 1" thick with 3mm plastic edge banding
- Full to floor or hanging pedestals available
- Pencil tray is standard on box-box-file pedestals
- High wall drawer sides accommodate front-to-back hanging file folders and eliminate the need for costly hanging file frames
- 1" adjustable leveling glides standard on all units. Double pedestal desks have eight, Single pedestal desks use six
- Steel chassis are finished with an Earth friendly electrostatically applied powder paint process that protects the environment and provides a durable finish
- Available in a range of colors and finishes - see Notes for details



Tops are 1" thick with 3mm plastic edge banding



Full to floor pedestals



High drawer sides accommodate hanging folders

GENERAL INFORMATION

- Tops are constructed of 45 lb. density particleboard with high performance thermally fused laminate
- All tops have Global’s preferred edging in matching color (i.e. wood grain surfaces feature edging with matching wood grain)
- Chassis incorporates an earth friendly electrostatically applied powder paint process that protects the environment and provides a durable finish
- GREENGUARD INDOOR AIR QUALITY CERTIFICATION - Global laminate and seating products are in compliance with stringent emission guidelines set out by the Greenguard Environmental Institute under the standards for low emitting products and materials. www.greenguard.org.
- **Level 2 Certified**

CONSTRUCTION

- Tops are constructed of 45 lb. density particleboard with high performance thermally fused laminate. Tops are flush with end panels.
- Chassis is prime cold rolled commercial quality steel
- 1" adjustable leveling glides standard on all units. Double pedestal desks have eight, single pedestal desks use six.
- High Pressure Tops are available in all laminate finishes at an extended lead time. Please see model # for pricing and availability
- Products specified with the high pressure laminate option are finished on the underside of the surface with a kraft paper backing.

MODESTY PANELS

- Standard modesty panel heights are 18" (¾) and 26" (full)
- Hanging pedestal models are standard with a 20" modesty panel

LOCKS

- Locks have removable cores for keying alike

STORAGE

- Full extension ball-bearing suspension on file drawers, ¾ extension ball-bearing suspension on box drawers for smooth and durable drawer movement
- High wall drawer sides accommodate front-to-back hanging file folders and eliminate the need for costly hanging file frames

GROMMETS

- Grommets are available in standard worksurface locations (left, center or right). Order as: **AG1, AG2 or AG3 - Add \$69**
- Grommet hole dimensions are 3 ¼" wide x 1 7/8" deep.

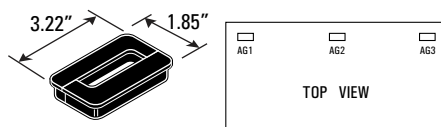

- Actual grommet locations on the worksurface are depicted in the example drawings shown below. Dimensions shown are actual measurements (in inches).

- Grommets are standard in corners, islands and extended corners only. Desks, returns and bridges have no standard grommet.

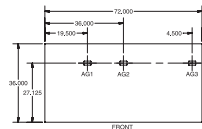

36 x 72 single pedestal left desks

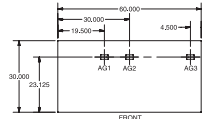

30 x 60 single pedestal left desks

- Grommets may be placed at non-standard locations. Order as: **AGS - Add \$69** A drawing must be supplied with vertical and horizontal dimensions to the center of the cut-out (as in drawing above). Please refer to CUSTOM GROMMET LOCATION FORM in the back reference section.

TOP FINISHES - LAMINATE

- ACJ Absolute Acajou
- ASN Asian Night
- AWC Avant Cherry
- AWH Avant Honey
- BLK Black
- BRC Brushed Cobalt
- CMB Clear Maple
- DES Dark Espresso
- DWT Designer White
- HGT Hayden Grey
- QTM Quartered Mahogany
- SOG Storm Grey
- TFW Tiger Fruitwood
- TWL Tiger Walnut
- WHE Walnut Heights
- WHC White Chocolate
- WGY Willow Grey
- WCR Winter Cherry

BODY FINISHES (INCLUDING PEDESTALS) - METAL

Standard Paint Finishes

- BLK Black
- BGR Business Grey
- CGR Charcoal
- DPT Desert Putty
- GRY Grey
- LGR Light Grey
- SGR Storm Grey
- NEV Nevada
- TSA Tahiti Sand

Premium Paint Finishes

- F29 Bone
- F09 Claret
- F23 Cloud
- DWT Designer White
- F33 Ice
- F30 Ivory
- F07 Metro
- F05 Moss
- F19 Navy
- F35 Oyster
- F32 Stone
- TU2 Tungsten 2
- F28 Willow

Textured Paint Finishes

- U04 Black Coffee
- T19 Dark Chocolate
- T20 Cappuccino
- J52 Mocha
- J23 Vanilla

CUSTOM PAINT FINISHES

- All special colors must use ONE uniform color per series (example: Steel Desks). Quantities of 1 to 10 add 10%; 11 or more are NO UPCHARGE.
- Mica and Metallic: 10% upcharge will apply.
- White special finishes can be applied at 10% upcharge.
- ALL NONSTANDARD FINISHES MUST BE APPROVED BY GLOBAL BEFORE ANY ORDER WILL BE ACCEPTED. LONGER LEAD TIMES WILL APPLY.

DOUBLE PEDESTAL DESKS

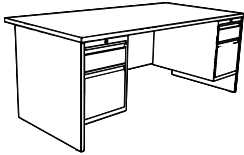

20" modesty

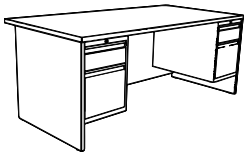

26" modesty

Double Pedestal Desk

MODEL#	DIMENSIONS D x W x H	FREIGHT CLASS	WT/LBS.	CUBIC FT.	LIST PRICE	HP ADD
SDM2448HH20	24 x 48 x 29	100	188	22.28	\$1433	
SDM2454HH20	24 x 54 x 29	100	201.50	24.98	\$1462	
SDM2460HH20	24 x 60 x 29	125	207	27.68	\$1490	
SDM2466HH20	24 x 66 x 29	125	211.50	30.38	\$1509	
SDM2472HH20	24 x 72 x 29	125	226	33.08	\$1523	
SDM2448HH26	24 x 48 x 29	100	192	22.28	\$1442	
SDM2454HH26	24 x 54 x 29	100	206	24.98	\$1473	
SDM2460HH26	24 x 60 x 29	125	212	27.68	\$1503	
SDM2466HH26	24 x 66 x 29	125	217	30.38	\$1523	
SDM2472HH26	24 x 72 x 29	125	232	33.08	\$1538	
SDM3048HH20	30 x 48 x 29	100	222.50	27.52	\$1764	
SDM3054HH20	30 x 54 x 29	125	237	30.86	\$1798	
SDM3060HH20	30 x 60 x 29	125	244	34.19	\$1822	
SDM3066HH20	30 x 66 x 29	125	254.50	37.53	\$1875	
SDM3072HH20	30 x 72 x 29	125	265	40.87	\$1914	
SDM3048HH26	30 x 48 x 29	100	226.50	27.52	\$1773	
SDM3054HH26	30 x 54 x 29	125	241.50	30.86	\$1808	
SDM3060HH26	30 x 60 x 29	125	248.50	34.19	\$1833	
SDM3066HH26	30 x 66 x 29	125	259.50	37.53	\$1888	
SDM3072HH26	30 x 72 x 29	125	271	40.87	\$1929	
SDM3660HH20	36 x 60 x 29	125	262.50	34.19	\$1932	
SDM3666HH20	36 x 66 x 29	125	270	44.68	\$1944	
SDM3672HH20	36 x 72 x 29	150	278	48.65	\$1954	
SDM3660HH26	36 x 60 x 29	125	267.50	34.19	\$1939	
SDM3666HH26	36 x 66 x 29	125	275.50	44.68	\$1959	
SDM3672HH26	36 x 72 x 29	150	283.50	48.65	\$1968	

Standard with **box/file** pedestals on both sides. Pedestal locks. One pencil tray.

- SDMxxxxHH20 has a 20" modesty panel
- SDM24xxBB26 has a 26" modesty panel
- 6.125" overhang on 36"D desks

Required Specifications

Top Finish
Body Finish

Optional Specifications

Grommet
HP laminate

DOUBLE PEDESTAL DESKS

MODEL# DIMENSIONS FREIGHT CLASS WT/LBS. CUBIC FT. LIST PRICE HP ADD

D x W x H

SDM2448BB18	24 x 48 x 29	100	184	22.28	\$1313
SDM2454BB18	24 x 54 x 29	125	197.50	24.98	\$1342
SDM2460BB18	24 x 60 x 29	125	203	27.68	\$1370
SDM2466BB18	24 x 66 x 29	125	208	30.38	\$1390
SDM2472BB18	24 x 72 x 29	125	222	33.08	\$1402
SDM2448BB26	24 x 48 x 29	100	188	22.28	\$1323
SDM2454BB26	24 x 54 x 29	100	202	24.98	\$1353
SDM2460BB26	24 x 60 x 29	125	208	27.68	\$1383
SDM2466BB26	24 x 66 x 29	125	213	30.38	\$1402
SDM2472BB26	24 x 72 x 29	125	228	33.08	\$1418
SDM3048BB18	30 x 48 x 29	125	202.50	27.52	\$1673
SDM3054BB18	30 x 54 x 29	125	217	30.86	\$1707
SDM3060BB18	30 x 60 x 29	125	224	34.19	\$1731
SDM3066BB18	30 x 66 x 29	125	234.50	37.53	\$1784
SDM3072BB18	30 x 72 x 29	125	270	40	\$1824
SDM3048BB26	30 x 48 x 29	125	206.50	27.52	\$1684
SDM3054BB26	30 x 54 x 29	125	221.50	30.86	\$1719
SDM3060BB26	30 x 60 x 29	125	228.50	34.19	\$1743
SDM3066BB26	30 x 66 x 29	125	240	37.53	\$1799
SDM3072BB26	30 x 72 x 29	125	251	40.87	\$1838
SDM3660BB18	36 x 60 x 29	125	242.50	34.19	\$1841
SDM3666BB18	36 x 66 x 29	150	250	44.68	\$1854
SDM3672BB18	36 x 72 x 29	150	258	48.65	\$1864
SDM3660BB26	36 x 60 x 29	125	247.50	34.19	\$1848
SDM3666BB26	36 x 66 x 29	150	255.50	44.68	\$1869
SDM3672BB26	36 x 72 x 29	150	263.50	48.65	\$1878



18" modesty



26" modesty

Double Pedestal Desk

Standard with full to floor **box/box/file** pedestals on both sides. Pedestal locks. One pencil tray.

- SDMxxxxBB18 has an 18" modesty panel
- SDM24xxBB26 has a 26" modesty panel
- 6.125" overhang on 36"D desks

Required Specifications

Top Finish
Body Finish

Optional Specifications

Grommet
HP laminate

DOUBLE PEDESTAL DESKS

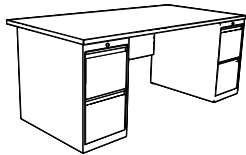

18" modesty

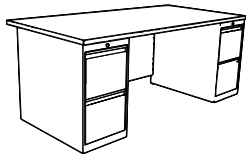

26" modesty

Double Pedestal Desk

MODEL#	DIMENSIONS D x W x H	FREIGHT CLASS	WT/LBS.	CUBIC FT.	LIST PRICE	HP ADD
SDM2448FF18	24 x 48 x 29	100	184	22.28	\$1313	
SDM2454FF18	24 x 54 x 29	125	197.50	24.98	\$1342	
SDM2460FF18	24 x 60 x 29	125	203	27.68	\$1370	
SDM2466FF18	24 x 66 x 29	125	208	30.38	\$1390	
SDM2472FF18	24 x 72 x 29	125	222	33.08	\$1402	
SDM2448FF26	24 x 48 x 29	100	188	22.28	\$1323	
SDM2454FF26	24 x 54 x 29	100	202	24.98	\$1353	
SDM2460FF26	24 x 60 x 29	125	208	27.68	\$1383	
SDM2466FF26	24 x 66 x 29	125	213	30.38	\$1402	
SDM2472FF26	24 x 72 x 29	125	228	33.08	\$1418	
SDM3048FF18	30 x 48 x 29	125	202.50	27.52	\$1673	
SDM3054FF18	30 x 54 x 29	125	217	30.86	\$1707	
SDM3060FF18	30 x 60 x 29	125	224	34.19	\$1731	
SDM3066FF18	30 x 66 x 29	125	234.50	37.53	\$1784	
SDM3072FF18	30 x 72 x 29	125	270	40	\$1824	
SDM3048FF26	30 x 48 x 29	125	206.50	27.52	\$1684	
SDM3054FF26	30 x 54 x 29	125	221.50	30.86	\$1719	
SDM3060FF26	30 x 60 x 29	125	228.50	34.19	\$1743	
SDM3066FF26	30 x 66 x 29	125	240	37.53	\$1799	
SDM3072FF26	30 x 72 x 29	150	240	40.87	\$1838	
SDM3660FF18	36 x 60 x 29	125	242.50	34.19	\$1841	
SDM3666FF18	36 x 66 x 29	150	250	44.68	\$1854	
SDM3672FF18	36 x 72 x 29	150	258	48.65	\$1864	
SDM3660FF26	36 x 60 x 29	125	247.50	34.19	\$1848	
SDM3666FF26	36 x 66 x 29	150	255.50	44.68	\$1869	
SDM3672FF26	36 x 72 x 29	150	263.50	48.65	\$1878	

Standard with full to floor **file/file** pedestals on both sides. Pedestal locks.

- SDMxxxxFF18 has an 18" modesty panel
- SDM24xxFF26 has a 26" modesty panel
- 6.125" overhang on 36"D desks

Required Specifications

Top Finish
Body Finish

Optional Specifications

Grommet
HP laminate

DOUBLE PEDESTAL DESKS

MODEL# DIMENSIONS FREIGHT CLASS WT/LBS. CUBIC FT. LIST PRICE HP ADD

D x W x H

SDM2448FB18	24 x 48 x 29	100	184	22.28	\$1313
SDM2454FB18	24 x 54 x 29	125	197.50	24.98	\$1342
SDM2460FB18	24 x 60 x 29	125	203	27.68	\$1370
SDM2466FB18	24 x 66 x 29	125	208	30.38	\$1390
SDM2472FB18	24 x 72 x 29	125	222	33.08	\$1402

SDM2448FB26	24 x 48 x 29	100	188	22.28	\$1323
SDM2454FB26	24 x 54 x 29	100	202	24.98	\$1353
SDM2460FB26	24 x 60 x 29	125	208	27.68	\$1383
SDM2466FB26	24 x 66 x 29	125	213	30.38	\$1402
SDM2472FB26	24 x 72 x 29	125	228	33.08	\$1418

SDM3048FB18	30 x 48 x 29	125	202.50	27.52	\$1673
SDM3054FB18	30 x 54 x 29	125	217	30.86	\$1707
SDM3060FB18	30 x 60 x 29	125	224	34.19	\$1731
SDM3066FB18	30 x 66 x 29	125	234.50	37.53	\$1784
SDM3072FB18	30 x 72 x 29	150	245	40.87	\$1824

SDM3048FB26	30 x 48 x 29	125	206.50	27.52	\$1684
SDM3054FB26	30 x 54 x 29	125	221.50	30.86	\$1719
SDM3060FB26	30 x 60 x 29	125	228.50	34.19	\$1743
SDM3066FB26	30 x 66 x 29	125	240	37.53	\$1799
SDM3072FB26	30 x 72 x 29	125	251	40.87	\$1838

SDM3660FB18	36 x 60 x 29	125	242.50	34.19	\$1841
SDM3666FB18	36 x 66 x 29	150	250	44.68	\$1854
SDM3672FB18	36 x 72 x 29	150	258	48.65	\$1864

SDM3660FB26	36 x 60 x 29	125	247.50	34.19	\$1848
SDM3666FB26	36 x 66 x 29	150	255.50	44.68	\$1869
SDM3672FB26	36 x 72 x 29	150	263.50	48.65	\$1878

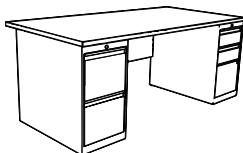

18" modesty

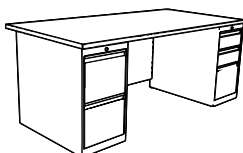

26" modesty

Double Pedestal Desk

Standard with full to floor **file/file** pedestal on **left** and **box/box/file** pedestal on **right**. Pedestal locks. One pencil tray.

- SDMxxxxFB18 has an 18" modesty panel
- SDMxxxxFB26 has a 26" modesty panel
- 6.125" overhang on 36"D desks

Required Specifications

Top Finish
Body Finish

Optional Specifications

Grommet
HP laminate

DOUBLE PEDESTAL DESKS

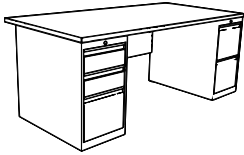

18" modesty



26" modesty

Double Pedestal Desk

MODEL#	DIMENSIONS D x W x H	FREIGHT CLASS	WT/LBS.	CUBIC FT.	LIST PRICE	HP ADD
SDM2448BF18	24 x 48 x 29	100	184	22.28	\$1313	
SDM2454BF18	24 x 54 x 29	125	197.50	24.98	\$1342	
SDM2460BF18	24 x 60 x 29	125	203	27.68	\$1370	
SDM2466BF18	24 x 66 x 29	125	208	30.38	\$1390	
SDM2472BF18	24 x 72 x 29	125	222	33.08	\$1402	
SDM2448BF26	24 x 48 x 29	100	188	22.28	\$1323	
SDM2454BF26	24 x 54 x 29	100	202	24.98	\$1353	
SDM2460BF26	24 x 60 x 29	125	208	27.68	\$1383	
SDM2466BF26	24 x 66 x 29	125	213	30.38	\$1402	
SDM2472BF26	24 x 72 x 29	125	228	33.08	\$1418	
SDM3048BF18	30 x 48 x 29	125	202.50	27.52	\$1673	
SDM3054BF18	30 x 54 x 29	125	217	30.86	\$1707	
SDM3060BF18	30 x 60 x 29	125	224	34.19	\$1731	
SDM3066BF18	30 x 66 x 29	125	234.50	37.53	\$1784	
SDM3072BF18	30 x 72 x 29	150	245	40.87	\$1824	
SDM3048BF26	30 x 48 x 29	125	206.50	27.52	\$1684	
SDM3054BF26	30 x 54 x 29	125	221.50	30.86	\$1719	
SDM3060BF26	30 x 60 x 29	125	228.50	34.19	\$1743	
SDM3066BF26	30 x 66 x 29	125	240	37.53	\$1799	
SDM3072BF26	30 x 72 x 29	125	251	40.87	\$1838	
SDM3660BF18	36 x 60 x 29	125	242.50	34.19	\$1841	
SDM3666BF18	36 x 66 x 29	150	250	44.68	\$1854	
SDM3672BF18	36 x 72 x 29	150	258	48.65	\$1864	
SDM3660BF26	36 x 60 x 29	125	247.50	34.19	\$1848	
SDM3666BF26	36 x 66 x 29	150	255.50	44.68	\$1869	
SDM3672BF26	36 x 72 x 29	150	263.50	48.65	\$1878	

Standard with full to floor **file/file** pedestal on **right** and **box/box/file** pedestal on **left**. Pedestal locks. One pencil tray.

- SDMxxxxBF18 has an 18" modesty panel
- SDMxxxxBF26 has a 26" modesty panel
- 6.125" overhang on 36"D desks

Required Specifications

Top Finish
Body Finish

Optional Specifications

Grommet
HP laminate

SINGLE PEDESTAL DESKS

MODEL# DIMENSIONS FREIGHT CLASS WT/LBS. CUBIC FT. LIST PRICE HP ADD

D x W x H

SDM2442BG18	24 x 42 x 29	125	140.50	19.58	\$1028
SDM2448BG18	24 x 48 x 29	125	146	22.28	\$1057
SDM2454BG18	24 x 54 x 29	125	160	24.98	\$1086
SDM2460BG18	24 x 60 x 29	150	165	27.68	\$1115
SDM2466BG18	24 x 66 x 29	150	170	30.38	\$1133
SDM2472BG18	24 x 72 x 29	150	184	33.08	\$1147

SDM2442BG26	24 x 42 x 29	125	144	19.58	\$1037
SDM2448BG26	24 x 48 x 29	125	150	22.28	\$1068
SDM2454BG26	24 x 54 x 29	125	164	24.98	\$1097
SDM2460BG26	24 x 60 x 29	125	170	27.68	\$1128
SDM2466BG26	24 x 66 x 29	150	175	30.38	\$1147
SDM2472BG26	24 x 72 x 29	150	190	33.08	\$1162

SDM3042BG18	30 x 42 x 29	125	159	24.19	\$1314
SDM3048BG18	30 x 48 x 29	125	165.50	27.52	\$1344
SDM3054BG18	30 x 54 x 29	150	180	30.86	\$1377
SDM3060BG18	30 x 60 x 29	150	187	34.19	\$1400
SDM3066BG18	30 x 66 x 29	150	197.50	37.53	\$1455
SDM3072BG18	30 x 72 x 29	150	208	40.87	\$1493

SDM3042BG26	30 x 42 x 29	125	162.50	24.19	\$1323
SDM3048BG26	30 x 48 x 29	125	169.50	27.52	\$1353
SDM3054BG26	30 x 54 x 29	150	184.50	30.86	\$1388
SDM3060BG26	30 x 60 x 29	150	191.50	34.19	\$1414
SDM3066BG26	30 x 66 x 29	150	203	37.53	\$1467
SDM3072BG26	30 x 72 x 29	150	214	40.87	\$1508

SDM3660BG18	36 x 60 x 29	125	210.50	34.19	\$1510
SDM3666BG18	36 x 66 x 29	150	218	44.68	\$1525
SDM3672BG18	36 x 72 x 29	150	226	48.65	\$1533

SDM3660BG26	36 x 60 x 29	125	215.50	34.19	\$1519
SDM3666BG26	36 x 66 x 29	150	223.50	44.68	\$1538
SDM3672BG26	36 x 72 x 29	150	231.50	48.65	\$1549



18" modesty



26" modesty

Single Pedestal Desk - Left

Standard with full to floor **box/box/file** pedestal on **left**. Pedestal lock. One pencil tray.

- SDMxxxBG18 has an 18" modesty panel
- SDMxxxBG26 has a 26" modesty panel
- 6.125" overhang on 36"D desks

Required Specifications

Top Finish
Body Finish

Optional Specifications

Grommet
HP laminate

SINGLE PEDESTAL DESKS

MODEL# DIMENSIONS FREIGHT CLASS WT/LBS. CUBIC FT. LIST PRICE HP ADD

D x W x H

SDM2442GB18	24 x 42 x 29	125	140.50	19.58	\$1028
SDM2448GB18	24 x 48 x 29	125	146	22.28	\$1057
SDM2454GB18	24 x 54 x 29	125	160	24.98	\$1086
SDM2460GB18	24 x 60 x 29	150	165	27.68	\$1115
SDM2466GB18	24 x 66 x 29	150	170	30.38	\$1133
SDM2472GB18	24 x 72 x 29	150	184	33.08	\$1147
SDM2442GB26	24 x 42 x 29	125	144	19.58	\$1037
SDM2448GB26	24 x 48 x 29	125	150	22.28	\$1068
SDM2454GB26	24 x 54 x 29	125	164	24.98	\$1097
SDM2460GB26	24 x 60 x 29	125	170	27.68	\$1128
SDM2466GB26	24 x 66 x 29	150	175	30.38	\$1147
SDM2472GB26	24 x 72 x 29	150	190	33.08	\$1162
SDM3042GB18	30 x 42 x 29	125	159	24.19	\$1314
SDM3048GB18	30 x 48 x 29	125	165.50	27.52	\$1344
SDM3054GB18	30 x 54 x 29	150	180	30.86	\$1377
SDM3060GB18	30 x 60 x 29	150	187	34.19	\$1400
SDM3066GB18	30 x 66 x 29	150	197.50	37.53	\$1455
SDM3072GB18	30 x 72 x 29	150	270	40	\$1493
SDM3042GB26	30 x 42 x 29	125	162.50	24.19	\$1323
SDM3048GB26	30 x 48 x 29	125	169.50	27.52	\$1353
SDM3054GB26	30 x 54 x 29	150	184.50	30.86	\$1388
SDM3060GB26	30 x 60 x 29	150	191.50	34.19	\$1414
SDM3066GB26	30 x 66 x 29	150	203	37.53	\$1467
SDM3072GB26	30 x 72 x 29	150	203	40.87	\$1508
SDM3660GB18	36 x 60 x 29	125	210.50	34.19	\$1510
SDM3666GB18	36 x 66 x 29	150	218	44.68	\$1525
SDM3672GB18	36 x 72 x 29	150	226	48.65	\$1533
SDM3660GB26	36 x 60 x 29	125	215.50	34.19	\$1519
SDM3666GB26	36 x 66 x 29	150	223.50	44.68	\$1538
SDM3672GB26	36 x 72 x 29	150	231.50	48.65	\$1549

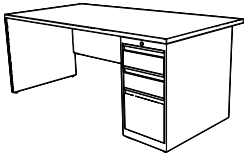

18" modesty

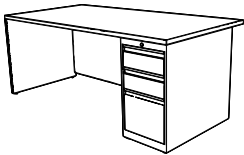

26" modesty

Single Pedestal Desk - Right

Standard with full to floor **box/box/file** pedestal on **right**. Pedestal lock.

- SDMxxxxGB18 has an 18" modesty panel
- SDM24xxGB26 has a 26" modesty panel
- 6.125" overhang on 36"D desks

Required Specifications

Top Finish
Body Finish

Optional Specifications

Grommet
HP laminate

SINGLE PEDESTAL DESKS

MODEL# DIMENSIONS FREIGHT CLASS WT/LBS. CUBIC FT. LIST PRICE HP ADD

D x W x H

SDM2442FG18	24 x 42 x 29	125	140.50	19.58	\$1028
SDM2448FG18	24 x 48 x 29	125	146	22.28	\$1057
SDM2454FG18	24 x 54 x 29	125	160	24.98	\$1086
SDM2460FG18	24 x 60 x 29	150	165	27.68	\$1115
SDM2466FG18	24 x 66 x 29	150	170	30.38	\$1133
SDM2472FG18	24 x 72 x 29	150	184	33.08	\$1147

SDM2442FG26	24 x 42 x 29	125	144	19.58	\$1037
SDM2448FG26	24 x 48 x 29	125	150	22.28	\$1068
SDM2454FG26	24 x 54 x 29	125	164	24.98	\$1097
SDM2460FG26	24 x 60 x 29	125	170	27.68	\$1128
SDM2466FG26	24 x 66 x 29	150	165.50	30.38	\$1147
SDM2472FG26	24 x 72 x 29	150	190	33.08	\$1162

SDM3042FG18	30 x 42 x 29	125	159	24.19	\$1314
SDM3048FG18	30 x 48 x 29	125	165.50	27.52	\$1344
SDM3054FG18	30 x 54 x 29	150	180	30.86	\$1377
SDM3060FG18	30 x 60 x 29	150	187	34.19	\$1400
SDM3066FG18	30 x 66 x 29	150	197.50	37.53	\$1455
SDM3072FG18	30 x 72 x 29	150	208	40.87	\$1493

SDM3042FG26	30 x 42 x 29	125	162.50	24.19	\$1323
SDM3048FG26	30 x 48 x 29	125	169.50	27.52	\$1353
SDM3054FG26	30 x 54 x 29	150	184.50	30.86	\$1388
SDM3060FG26	30 x 60 x 29	150	191.50	34.19	\$1414
SDM3066FG26	30 x 66 x 29	150	203	37.53	\$1467
SDM3072FG26	30 x 72 x 29	150	214	40.87	\$1508

SDM3660FG18	36 x 60 x 29	125	210.50	34.19	\$1510
SDM3666FG18	36 x 66 x 29	150	218	44.68	\$1525
SDM3672FG18	36 x 72 x 29	150	226	48.65	\$1533

SDM3660FG26	36 x 60 x 29	125	215.50	34.19	\$1519
SDM3666FG26	36 x 66 x 29	150	223.50	44.68	\$1538
SDM3672FG26	36 x 72 x 29	150	231.50	48.65	\$1549

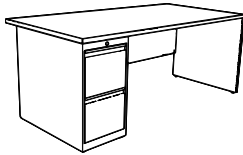

18" modesty

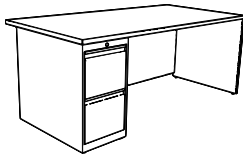

26" modesty

Single Pedestal Desk - Left

Standard with full to floor **file/file** pedestal on **left**. Pedestal lock.

- SDMxxxxFG18 has an 18" modesty panel
- SDMxxxxFG26 has a 26" modesty panel
- 6.125" overhang on 36"D desks

Required Specifications

Top Finish
Body Finish

Optional Specifications

Grommet
HP laminate

SINGLE PEDESTAL DESKS

MODEL# DIMENSIONS FREIGHT CLASS WT/LBS. CUBIC FT. LIST PRICE HP ADD

D x W x H

SDM2442GF18	24 x 42 x 29	125	140.50	19.58	\$1028
SDM2448GF18	24 x 48 x 29	125	146	22.28	\$1057
SDM2454GF18	24 x 54 x 29	125	160	24.98	\$1086
SDM2460GF18	24 x 60 x 29	150	165	27.68	\$1115
SDM2466GF18	24 x 66 x 29	150	170	30.38	\$1133
SDM2472GF18	24 x 72 x 29	150	184	33.08	\$1147
SDM2442GF26	24 x 42 x 29	125	144	19.58	\$1037
SDM2448GF26	24 x 48 x 29	125	150	22.28	\$1068
SDM2454GF26	24 x 54 x 29	125	164	24.98	\$1097
SDM2460GF26	24 x 60 x 29	125	170	27.68	\$1128
SDM2466GF26	24 x 66 x 29	150	175	30.38	\$1147
SDM2472GF26	24 x 72 x 29	150	190	33.08	\$1162
SDM3042GF18	30 x 42 x 29	125	159	24.19	\$1314
SDM3048GF18	30 x 48 x 29	125	165.50	27.52	\$1344
SDM3054GF18	30 x 54 x 29	150	180	30.86	\$1377
SDM3060GF18	30 x 60 x 29	150	187	34.19	\$1400
SDM3066GF18	30 x 66 x 29	150	197.50	37.53	\$1455
SDM3072GF18	30 x 72 x 29	150	208	40.87	\$1493
SDM3042GF26	30 x 42 x 29	125	162.50	24.19	\$1323
SDM3048GF26	30 x 48 x 29	125	169.50	27.52	\$1353
SDM3054GF26	30 x 54 x 29	150	184.50	30.86	\$1388
SDM3060GF26	30 x 60 x 29	150	191.50	34.19	\$1414
SDM3066GF26	30 x 66 x 29	150	203	37.53	\$1467
SDM3072GF26	30 x 72 x 29	150	214	40.87	\$1508
SDM3660GF18	36 x 60 x 29	125	210.50	34.19	\$1510
SDM3666GF18	36 x 66 x 29	150	218	44.68	\$1525
SDM3672GF18	36 x 72 x 29	150	226	48.65	\$1533
SDM3660GF26	36 x 60 x 29	125	215.50	34.19	\$1519
SDM3666GF26	36 x 66 x 29	150	223.50	44.68	\$1538
SDM3672GF26	36 x 72 x 29	150	231.50	48.65	\$1549

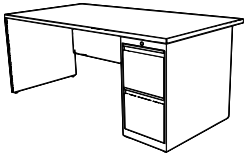

18" modesty

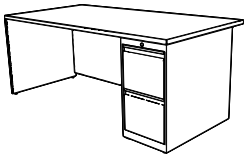

26" modesty

Single Pedestal Desk - Right

Standard with full to floor **file/file** pedestal on **right**. Pedestal lock.

- SDMxxxxGF18 has an 18" modesty panel
- SDMxxxxGF26 has a 26" modesty panel
- 6.125" overhang on 36"D desks

Required Specifications

Top Finish
Body Finish

Optional Specifications

Grommet
HP laminate

SINGLE PEDESTAL DESKS

MODEL# DIMENSIONS FREIGHT CLASS WT/LBS. CUBIC FT. LIST PRICE HP ADD

D x W x H

SDM2442HG20	24 x 42 x 29	125	143	19.58	\$1089
SDM2448HG20	24 x 48 x 29	125	148	22.28	\$1117
SDM2454HG20	24 x 54 x 29	125	161.50	24.98	\$1146
SDM2460HG20	24 x 60 x 29	125	167	27.68	\$1176
SDM2466HG20	24 x 66 x 29	150	172	30.38	\$1194
SDM2472HG20	24 x 72 x 29	150	186	33.08	\$1208

SDM2442HG26	24 x 42 x 29	125	146	19.58	\$1097
SDM2448HG26	24 x 48 x 29	125	152	22.28	\$1128
SDM2454HG26	24 x 54 x 29	125	166	24.98	\$1157
SDM2460HG26	24 x 60 x 29	125	172	27.68	\$1187
SDM2466HG26	24 x 66 x 29	150	177	30.38	\$1208
SDM2472HG26	24 x 72 x 29	150	192	33.08	\$1223

SDM3042HG20	30 x 42 x 29	125	169	24.19	\$1359
SDM3048HG20	30 x 48 x 29	125	175.50	27.52	\$1388
SDM3054HG20	30 x 54 x 29	125	190	30.86	\$1422
SDM3060HG20	30 x 60 x 29	150	197	34.19	\$1446
SDM3066HG20	30 x 66 x 29	150	207.50	37.53	\$1499
SDM3072HG20	30 x 72 x 29	150	218	40.87	\$1538

SDM3042HG26	30 x 42 x 29	125	172.50	24.19	\$1368
SDM3048HG26	30 x 48 x 29	125	180	27.52	\$1398
SDM3054HG26	30 x 54 x 29	125	194.50	30.86	\$1433
SDM3060HG26	30 x 60 x 29	150	201.50	34.19	\$1458
SDM3066HG26	30 x 66 x 29	150	213	37.53	\$1513
SDM3072HG26	30 x 72 x 29	150	224	40.87	\$1553

SDM3660HG20	36 x 60 x 29	125	220.50	34.19	\$1556
SDM3666HG20	36 x 66 x 29	150	228	44.68	\$1569
SDM3672HG20	36 x 72 x 29	150	238	48.65	\$1577

SDM3660HG26	36 x 60 x 29	125	225.50	34.19	\$1563
SDM3666HG26	36 x 66 x 29	150	233.50	44.68	\$1584
SDM3672HG26	36 x 72 x 29	150	241.50	48.65	\$1593

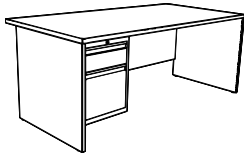

20" modesty

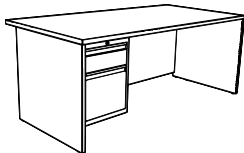

26" modesty

Single Pedestal Desk - Left

Standard with **box/file** pedestal on **left**. Pedestal lock. One pencil tray.

- SDMxxxHG20 has a 20" modesty panel
- SDMxxxHG26 has a 26" modesty panel
- 6.125" overhang on 36"D desks

Required Specifications

Top Finish
Body Finish

Optional Specifications

Grommet
HP laminate

SINGLE PEDESTAL DESKS

MODEL# DIMENSIONS FREIGHT CLASS WT/LBS. CUBIC FT. LIST PRICE HP ADD

D x W x H

SDM2442GH20	24 x 42 x 29	125	143	19.58	\$1089
SDM2448GH20	24 x 48 x 29	125	148	22.28	\$1117
SDM2454GH20	24 x 54 x 29	125	161.50	24.98	\$1146
SDM2460GH20	24 x 60 x 29	125	167	27.68	\$1176
SDM2466GH20	24 x 66 x 29	150	172	30.38	\$1194
SDM2472GH20	24 x 72 x 29	150	186	33.08	\$1208
SDM2442GH26	24 x 42 x 29	125	146	19.58	\$1097
SDM2448GH26	24 x 48 x 29	125	152	22.28	\$1128
SDM2454GH26	24 x 54 x 29	125	166	24.98	\$1157
SDM2460GH26	24 x 60 x 29	125	172	27.68	\$1187
SDM2466GH26	24 x 66 x 29	150	177	30.38	\$1208
SDM2472GH26	24 x 72 x 29	150	192	33.08	\$1223
SDM3042GH20	30 x 42 x 29	125	169	24.19	\$1359
SDM3048GH20	30 x 48 x 29	125	175.50	27.52	\$1388
SDM3054GH20	30 x 54 x 29	125	190	30.86	\$1422
SDM3060GH20	30 x 60 x 29	150	197	34.19	\$1446
SDM3066GH20	30 x 66 x 29	150	207.50	37.53	\$1499
SDM3072GH20	30 x 72 x 29	150	218	40.87	\$1538
SDM3042GH26	30 x 42 x 29	125	172.50	24.19	\$1368
SDM3048GH26	30 x 48 x 29	125	180	27.52	\$1398
SDM3054GH26	30 x 54 x 29	125	194.50	30.86	\$1433
SDM3060GH26	30 x 60 x 29	150	201.50	34.19	\$1458
SDM3066GH26	30 x 66 x 29	150	213	37.53	\$1513
SDM3072GH26	30 x 72 x 29	150	224	40.87	\$1553
SDM3660GH20	36 x 60 x 29	125	220.50	34.19	\$1556
SDM3666GH20	36 x 66 x 29	150	228	44.68	\$1569
SDM3672GH20	36 x 72 x 29	150	241.50	48.65	\$1577
SDM3660GH26	36 x 60 x 29	125	225.50	34.19	\$1563
SDM3666GH26	36 x 66 x 29	150	233.50	44.68	\$1584
SDM3672GH26	36 x 72 x 29	150	236	48.65	\$1593

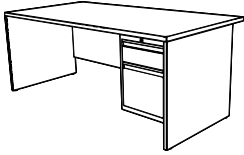

20" modesty

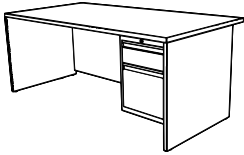

26" modesty

Single Pedestal Desk - Right

Standard with **box/file** pedestal on **right**. Pedestal lock. One pencil tray.

- SDMxxxxGH20 has a 20" modesty panel
- SDMxxxxGH26 has a 26" modesty panel
- 6.125" overhang on 36"D desks

Required Specifications

Paint Finish
Body Finish

Optional Specifications

Grommet
HP laminate

DESK SHELLS

MODEL# DIMENSIONS FREIGHT CLASS WT/LBS. CUBIC FT. LIST PRICE HP ADD

D x W x H

SDM2442GG18	24 x 42 x 29	150	103	19.58	\$773
SDM2448GG18	24 x 48 x 29	150	108	22.28	\$803
SDM2454GG18	24 x 54 x 29	150	122	24.98	\$831
SDM2460GG18	24 x 60 x 29	150	127.50	27.68	\$860
SDM2466GG18	24 x 66 x 29	150	170	30.38	\$878
SDM2472GG18	24 x 72 x 29	150	146.50	33.08	\$892

SDM2442GG26	24 x 42 x 29	150	106	19.58	\$782
SDM2448GG26	24 x 48 x 29	150	112	22.28	\$812
SDM2454GG26	24 x 54 x 29	150	126	24.98	\$842
SDM2460GG26	24 x 60 x 29	150	132	27.68	\$873
SDM2466GG26	24 x 66 x 29	150	175	30.38	\$892
SDM2472GG26	24 x 72 x 29	150	152	33.08	\$907

SDM3042GG18	30 x 42 x 29	150	122	24.19	\$984
SDM3048GG18	30 x 48 x 29	150	128.50	27.52	\$1012
SDM3054GG18	30 x 54 x 29	150	143	30.86	\$1046
SDM3060GG18	30 x 60 x 29	150	150	34.19	\$1070
SDM3066GG18	30 x 66 x 29	150	160.50	37.53	\$1123
SDM3072GG18	30 x 72 x 29	150	171	40.87	\$1162

SDM3042GG26	30 x 42 x 29	150	125.50	24.19	\$992
SDM3048GG26	30 x 48 x 29	150	132.50	27.52	\$1057
SDM3054GG26	30 x 54 x 29	150	147.50	30.86	\$1057
SDM3060GG26	30 x 60 x 29	150	146	34.19	\$1082
SDM3066GG26	30 x 66 x 29	150	166	37.53	\$1138
SDM3072GG26	30 x 72 x 29	150	177	40.87	\$1178

SDM3660GG18	36 x 60 x 29	150	178.50	34.19	\$1180
SDM3666GG18	36 x 66 x 29	150	222	44.68	\$1194
SDM3672GG18	36 x 72 x 29	150	205	48.65	\$1203

SDM3660GG26	36 x 60 x 29	150	183.50	34.19	\$1190
SDM3666GG26	36 x 66 x 29	150	227.50	44.68	\$1208
SDM3672GG26	36 x 72 x 29	150	220	48.65	\$1218

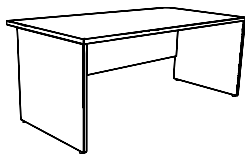

18" modesty

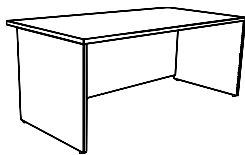

26" modesty

Desk Shell

- SDMxxxGG18 has an 18" modesty panel
- SDMxxxGG26 has a 26" modesty panel
- 6.125" overhang on 36"D desks

Required Specifications

Paint Finish
Body Finish

Optional Specifications

HP laminate

CORNERS

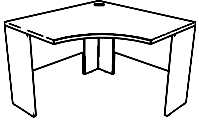

Curved Corner, 20" Throat

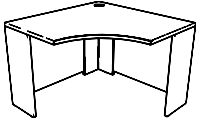

Curved Corner, 24" Throat

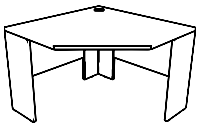

5-Sided Corner, 20" Throat

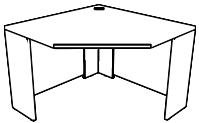

5-Sided Corner, 24" Throat

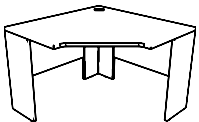

Keyboard Corner, 20" Throat

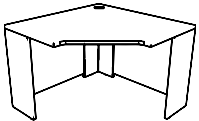

Keyboard Corner, 24" Throat

MODEL#	DIMENSIONS	FREIGHT CLASS	WT/LBS.	CUBIC FT.	LIST PRICE	HP ADD
--------	------------	---------------	---------	-----------	------------	--------

D x W x H

SCM2036RND18	36 x 36 x 29	150	116.80	24.82	\$1225	
SCM2042RND18	42 x 42 x 29	250	127.80	33.40	\$1263	
SCM2036RND26	36 x 36 x 29	150	121.10	24.82	\$1243	
SCM2042RND26	42 x 42 x 29	250	133.30	33.40	\$1281	

- SCM20xxRND18 has an 18" modesty panel
- SCM20xxRND26 has a 26" modesty panel

SCM2436RND18	36 x 36 x 29	150	116.80	24.82	\$1225	
SCM2442RND18	42 x 42 x 29	150	142.10	33.40	\$1263	
SCM2436RND26	36 x 36 x 29	150	121.10	24.82	\$1243	
SCM2442RND26	42 x 42 x 29	150	147.60	33.40	\$1281	

- SCM24xxRND18 has an 18" modesty panel
- SCM24xxRND26 has a 26" modesty panel

SCM2036STR18	36 x 36 x 29	150	118.90	24.82	\$1216	
SCM2042STR18	42 x 42 x 29	250	131.80	33.40	\$1252	
SCM2036STR26	36 x 36 x 29	150	123.30	24.82	\$1232	
SCM2042STR26	42 x 42 x 29	150	137.30	33.40	\$1270	

- SCM20xxSTR18 has an 18" modesty panel
- SCM20xxSTR26 has a 26" modesty panel

SCM2436STR18	36 x 36 x 29	150	118.90	24.82	\$1216	
SCM2442STR18	42 x 42 x 29	250	131.80	33.40	\$1252	
SCM2436STR26	36 x 36 x 29	150	123.30	24.82	\$1232	
SCM2442STR26	42 x 42 x 29	150	137.30	33.40	\$1270	

- SCM24xxSTR18 has an 18" modesty panel
- SCM24xxSTR26 has a 26" modesty panel

SCM2036SVR18	36 x 36 x 29	150	117.60	24.82	\$1241	
SCM2042SVR18	42 x 42 x 29	250	130	33.40	\$1279	
SCM2036SVR26	36 x 36 x 29	150	122	24.82	\$1258	
SCM2042SVR26	42 x 42 x 29	150	135.50	33.40	\$1295	

- SCM20xxSVR18 has an 18" modesty panel
- SCM20xxSVR26 has a 26" modesty panel

SCM2436SVR18	36 x 36 x 29	150	117.60	24.82	\$1241	
SCM2442SVR18	42 x 42 x 29	250	130	33.40	\$1279	
SCM2436SVR26	36 x 36 x 29	150	122	24.82	\$1258	
SCM2442SVR26	42 x 42 x 29	250	132.30	33.40	\$1295	

- SCM24xxSVR18 has an 18" modesty panel
- SCM24xxSVR26 has a 26" modesty panel

Required Specifications

Top Finish
Body Finish

Optional Specifications

Grommet
HP laminate

LEFT EXTENDED CORNERS

MODEL# DIMENSIONS FREIGHT CLASS WT./LBS. CUBIC FT. LIST PRICE HP ADD

D x W x H

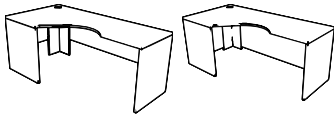

SDM2066FFL18	36 x 66 x 29	250	154.50	44.68	\$1143
SDM2072FFL18	36 x 72 x 29	250	169	48.65	\$1143
SDM2066FFL26	36 x 66 x 29	250	159	44.68	\$1162
SDM2072FFL26	36 x 72 x 29	250	173.50	48.65	\$1162

Left Extended Corner, 20" Throat

Extended worksurface on **right**. **Full end panels on left and right**. Connects to **24"D** space saver returns and **20"D** returns.

- SDM20xxFFL18 has an 18" modesty panel • SDM20xxFFL26 has a 26" modesty panel
- GWPSS pedestals **will not fit** properly under the extended end of **66" w** extended corners; available space measures 13.8"

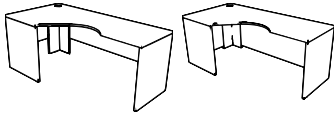

SDM2466FFL18	36 x 66 x 29	250	158.50	44.68	\$1203
SDM2472FFL18	36 x 72 x 29	250	173	48.65	\$1288
SDM2466FFL26	36 x 66 x 29	250	163	44.68	\$1223
SDM2472FFL26	36 x 72 x 29	250	177.50	48.65	\$1303

Left Extended Corner, 24" Throat

Extended worksurface on **right**. **Full end panels on left and right**. Connects to **30"D** space saver returns and **24"D** returns.

- SDM24xxFFL18 has an 18" modesty panel • SDM24xxFFL26 has a 26" modesty panel
- GWPSS pedestals **will not fit** properly under the extended end of **66" w** extended corners; available space measures 13.8"

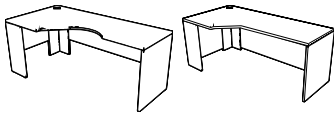

SDM2066NFL18	36 x 66 x 29	250	142.50	44.68	\$1113
SDM2072NFL18	36 x 72 x 29	250	157	48.65	\$1113
SDM2066NFL26	36 x 66 x 29	250	147	44.68	\$1132
SDM2072NFL26	36 x 72 x 29	250	161.50	48.65	\$1132

Left Extended Corner, 20" Throat

Extended worksurface on **right**. **Narrow end panel on left. Full end panel on right**. Connects to **24"D** space saver return or **20"D** returns. Corner has one grommet.

- SDM20xxNFL18 has an 18" modesty panel • SDM20xxNFL26 has a 26" modesty panel
- GWPSS pedestals **will not fit** properly under the extended end of **66" w** extended corners; available space measures 13.8"

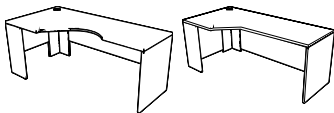

SDM2466NFL18	36 x 66 x 29	250	146.50	44.68	\$1173
SDM2472NFL18	36 x 72 x 29	250	161	48.65	\$1203
SDM2466NFL26	36 x 66 x 29	250	151	44.68	\$1193
SDM2472NFL26	36 x 72 x 29	250	165.50	48.65	\$1223

Left Extended Corner, 24" Throat

Extended worksurface on **right**. **Narrow end panel on left. Full end panel on right**. Connects to **30"D** space saver return or **24"D** returns. Corner has one grommet.

- SDM24xxNFL18 has an 18" modesty panel. • SDM24xxNFL26 has a 26" modesty panel
- GWPSS pedestals **will not fit** properly under the extended end of **66" w** extended corners; available space measures 13.8"

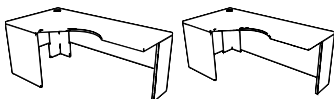

SDM2066FNL18	36 x 66 x 29	250	142.50	44.68	\$1113
SDM2072FNL18	36 x 72 x 29	250	157	48.65	\$1113
SDM2066FNL26	36 x 66 x 29	250	147	44.68	\$1132
SDM2072FNL26	36 x 72 x 29	250	161.50	48.65	\$1132

Left Extended Corner, 20" Throat

Extended worksurface on **right**. **Narrow end panel on right. Full end panel on left**. Connects to **24"D** space saver returns or **20"D** returns. Corner has one grommet.

- SDM20xxFNL18 has an 18" modesty panel • SDM20xxFNL26 has a 26" modesty panel
- GWPSS pedestals **will not fit** properly under the extended end of **66" w** extended corners; available space measures 13.8"

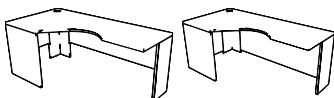

SDM2466FNL18	36 x 66 x 29	250	146.50	44.68	\$1173
SDM2472FNL18	36 x 72 x 29	250	161	48.65	\$1203
SDM2466FNL26	36 x 66 x 29	250	151	44.68	\$1193
SDM2472FNL26	36 x 72 x 29	250	165.50	48.65	\$1223

Left Extended Corner, 24" Throat

Extended worksurface on **right**. **Narrow end panel on right. Full end panel on left**. Connects to **30"D** space saver returns or **24"D** returns. Corner has one grommet.

- SDM24xxFNL18 has an 18" modesty panel • SDM24xxFNL26 has a 26" modesty panel
- GWPSS pedestals **will not fit** properly under the extended end of **66" w** extended corners; available space measures 13.8"

Required Specifications

Top Finish
Body Finish

Optional Specifications

Grommet
HP laminate

RIGHT EXTENDED CORNERS

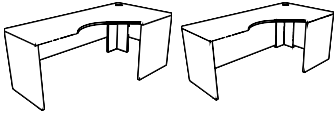

Right Extended Corner, 20" Throat

MODEL#	DIMENSIONS D x W x H	FREIGHT CLASS	WT./LBS.	CUBIC FT.	LIST PRICE	HP ADD
SDM2066FFR18	36 x 66 x 29	250	154.50	44.68	\$1143	
SDM2072FFR18	36 x 72 x 29	250	169	48.65	\$1143	
SDM2066FFR26	36 x 66 x 29	250	159	44.68	\$1162	
SDM2072FFR26	36 x 72 x 29	250	173.50	48.65	\$1162	

Extended worksurface on **left. Full end panels on left and right.** Connects to **24"D** space saver return and **20"D** returns.

- SDM20xxFFR18 has an 18" modesty panel • SDM20xxFFR26 has a 26" modesty panel
- GWPSS pedestals **will not fit** properly under the extended end of **66" w** extended corners; available space measures 13.8"

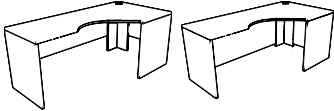

Right Extended Corner, 24" Throat

SDM2466FFR18	36 x 66 x 29	250	158.50	44.68	\$1203	
SDM2472FFR18	36 x 72 x 29	250	173	48.65	\$1288	
SDM2466FFR26	36 x 66 x 29	250	163	44.68	\$1223	
SDM2472FFR26	36 x 72 x 29	250	177.50	48.65	\$1303	

Extended worksurface on **left. Full end panels on left and right.** Connects to **30"D** space saver return and **24"D** returns.

- SDM24xxFFR18 has an 18" modesty panel • SDM24xxFFR26 has a 26" modesty panel
- GWPSS pedestals **will not fit** properly under the extended end of **66" w** extended corners; available space measures 13.8"

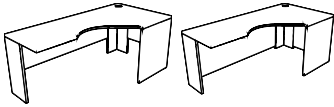

Right Extended Corner, 20" Throat

SDM2066NFR18	36 x 66 x 29	250	142.50	44.68	\$1113	
SDM2072NFR18	36 x 72 x 29	250	157	48.65	\$1113	
SDM2066NFR26	36 x 66 x 29	250	147	44.68	\$1132	
SDM2072NFR26	36 x 72 x 29	250	161.50	48.65	\$1132	

Extended worksurface on **left. Narrow end panel on left. Full end panel on right.** Connects to **24"D** space saver return or **20"D** returns. Corner has one grommet.

- SDM20xxNFR18 has an 18" modesty panel • SDM20xxNFR26 has a 26" modesty panel
- GWPSS pedestals **will not fit** properly under the extended end of **66" w** extended corners; available space measures 13.8"

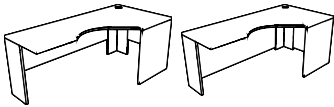

Right Extended Corner, 24" Throat

SDM2466NFR18	36 x 66 x 29	250	146.50	44.68	\$1173	
SDM2472NFR18	36 x 72 x 29	250	161	48.65	\$1203	
SDM2466NFR26	36 x 66 x 29	250	151	44.68	\$1193	
SDM2472NFR26	36 x 72 x 29	250	165.50	48.65	\$1223	

Extended worksurface on **left. Narrow end panel on left. Full end panel on right.** Connects to **30"D** space saver return or **24"D** returns. Corner has one grommet.

- SDM24xxNFR18 has an 18" modesty panel • SDM24xxNFR26 has a 26" modesty panel
- GWPSS pedestals **will not fit** properly under the extended end of **66" w** extended corners; available space measures 13.8"

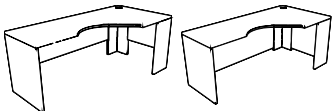

Right Extended Corner, 20" Throat

SDM2066FNR18	36 x 66 x 29	250	142.50	44.68	\$1113	
SDM2072FNR18	36 x 72 x 29	250	157	48.65	\$1113	
SDM2066FNR26	36 x 66 x 29	250	147	44.68	\$1132	
SDM2072FNR26	36 x 72 x 29	250	161.50	48.65	\$1132	

Extended worksurface on **left. Narrow end panel on right. Full end panel on left.** Connects to **24"D** space saver returns or **20"D** returns. Corner has one grommet.

- SDM20xxFNR18 has an 18" modesty panel • SDM20xxFNR26 has a 26" modesty panel
- GWPSS pedestals **will not fit** properly under the extended end of **66" w** extended corners; available space measures 13.8"

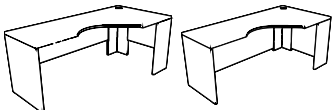

Right Extended Corner, 24" Throat

SDM2466FNR18	36 x 66 x 29	250	146.50	44.68	\$1173	
SDM2472FNR18	36 x 72 x 29	250	161	48.65	\$1203	
SDM2466FNR26	36 x 66 x 29	250	151	44.68	\$1193	
SDM2472FNR26	36 x 72 x 29	250	165.50	48.65	\$1223	

Extended worksurface on **left. Narrow end panel on right. Full end panel on left.** Connects to **30"D** space saver returns or **24"D** returns. Corner has one grommet.

- SDM24xxFNR18 has an 18" modesty panel • SDM24xxFNR26 has a 26" modesty panel.
- GWPSS pedestals **will not fit** properly under the extended end of **66" w** extended corners; available space measures 13.8"

Required Specifications

Top Finish
Body Finish

Optional Specifications

Grommet
HP laminate

ISLANDS

MODEL# DIMENSIONS FREIGHT CLASS WT./LBS. CUBIC FT. LIST PRICE HP ADD

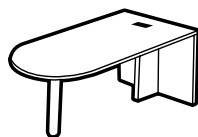

"D" Island - Full End Panel & Post (T-Base)

D x W x H					
SDIM3060	30 x 60 x 29	150	150	34.19	\$907
SDIM3066	30 x 66 x 29	150	205	37.53	\$972
SDIM3072	30 x 72 x 29	150	220	40.87	\$1035
SDIM3660	36 x 60 x 29	250	157	40.70	\$898
SDIM3666	36 x 66 x 29	150	212	44.67	\$957
SDIM3672	36 x 72 x 29	150	227	48.20	\$1017

Connects to narrow end panel. Attaching hardware included. **Not freestanding.**

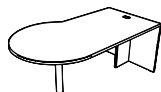

"P" Island LEFT - Full End Panel & Post (T-Base)

SPIM3060L	30 x 60 x 29	150	160	34.19	\$898
SPIM3066L	30 x 66 x 29	150	215	37.53	\$957
SPIM3072L	30 x 72 x 29	150	230	40.87	\$1017
SPIM3660L	36 x 60 x 29	250	113	52	\$1073
SPIM3666L	36 x 66 x 29	250	113	52	\$1162
SPIM3672L	36 x 72 x 29	150	237	48.20	\$1252

Connects to left side of worksurface. Attaching hardware included. **Not freestanding.** Grommet in worksurface.



"P" Island RIGHT - Full End Panel & Post (T-Base)

SPIM3060R	30 x 60 x 29	150	160	34.19	\$898
SPIM3066R	30 x 66 x 29	150	215	37.53	\$957
SPIM3072R	30 x 72 x 29	150	230	40.87	\$1017
SPIM3660R	36 x 60 x 29	250	113	52	\$1073
SPIM3666R	36 x 66 x 29	250	113	52	\$1162
SPIM3672R	36 x 72 x 29	150	237	48.20	\$1252

Connects to right side of worksurface. Attaching hardware included. **Not freestanding.** Grommet in worksurface.

BRIDGES

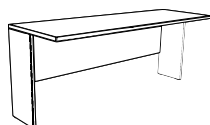

18" modesty

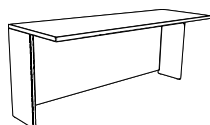

26" modesty

Bridge

SBM243018	24 x 36 x 29	250	56	14.18	\$654
SBM243618	24 x 36 x 29	250	67.50	16.88	\$683
SBM244218	24 x 42 x 29	150	79	19.58	\$713
SBM244818	24 x 48 x 29	250	84.50	22.28	\$742
SBM245418	24 x 54 x 29	250	98	24.98	\$771
SBM246018	24 x 60 x 29	250	103.50	27.68	\$799
SBM246618	24 x 66 x 29	250	108	30.38	\$818
SBM247218	24 x 72 x 29	250	122.50	33.08	\$833
SBM243026	24 x 36 x 29	150	58	14.18	\$663
SBM243626	24 x 36 x 29	150	70	16.88	\$692
SBM244226	24 x 42 x 29	150	82	19.58	\$723
SBM244826	24 x 48 x 29	250	88	22.28	\$751
SBM245426	24 x 54 x 29	150	102	24.98	\$782
SBM246026	24 x 60 x 29	250	108	27.68	\$812
SBM246626	24 x 66 x 29	250	113.50	30.38	\$833
SBM247226	24 x 72 x 29	250	128	33.08	\$847

- SBM24xx18 has an 18" modesty panel
- SBM24xx26 has a 26" modesty panel

Required Specifications

Top Finish
Body Finish

Optional Specifications

Grommet
HP laminate

RETURNS

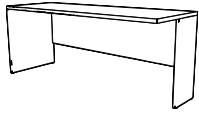

18" modesty

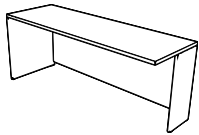

26" modesty

Return Shell - Left

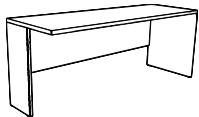

18" modesty

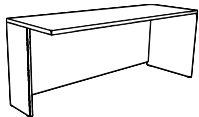

26" modesty

Return Shell - Right

MODEL#	DIMENSIONS D x W x H	FREIGHT CLASS	WT/LBS.	CUBIC FT.	LIST PRICE	HP ADD
SRM2430LG18	24 x 30 x 29	150	80	14.18	\$685	
SRM2436LG18	24 x 36 x 29	125	120	20	\$714	
SRM2442LG18	24 x 42 x 29	150	91	19.58	\$743	
SRM2448LG18	24 x 48 x 29	150	96.50	22.28	\$772	
SRM2454LG18	24 x 54 x 29	150	110	24.98	\$801	
SRM2460LG18	24 x 60 x 29	150	115.50	27.68	\$830	
SRM2466LG18	24 x 66 x 29	250	120	30.38	\$849	
SRM2472LG18	24 x 72 x 29	150	134.50	33.08	\$862	
SRM2430LG26	24 x 30 x 29	150	82	14.18	\$692	
SRM2436LG26	24 x 36 x 29	150	83	16.88	\$723	
SRM2442LG26	24 x 42 x 29	150	94	19.58	\$751	
SRM2448LG26	24 x 48 x 29	150	100	22.28	\$782	
SRM2454LG26	24 x 54 x 29	150	114	24.98	\$812	
SRM2460LG26	24 x 60 x 29	150	120	27.68	\$842	
SRM2466LG26	24 x 66 x 29	150	125.50	30.38	\$862	
SRM2472LG26	24 x 72 x 29	150	140	33.08	\$877	

- SRM24xxLG18 has an 18" modesty panel
- SRM24xxLG26 has a 26" modesty panel

SRM2430RG18	24 x 30 x 29	150	80	14.18	\$685	
SRM2436RG18	24 x 36 x 29	125	120	20	\$714	
SRM2442RG18	24 x 42 x 29	150	91	19.58	\$743	
SRM2448RG18	24 x 48 x 29	150	96.50	22.28	\$772	
SRM2454RG18	24 x 54 x 29	150	110	24.98	\$801	
SRM2460RG18	24 x 60 x 29	150	115.50	27.68	\$830	
SRM2466RG18	24 x 66 x 29	250	120	30.38	\$849	
SRM2472RG18	24 x 72 x 29	150	134.50	33.08	\$862	
SRM2430RG26	24 x 30 x 29	150	82	14.18	\$692	
SRM2436RG26	24 x 36 x 29	150	83	16.88	\$723	
SRM2442RG26	24 x 42 x 29	150	94	19.58	\$751	
SRM2448RG26	24 x 48 x 29	150	100	22.28	\$782	
SRM2454RG26	24 x 54 x 29	150	114	24.98	\$812	
SRM2460RG26	24 x 60 x 29	150	120	27.68	\$842	
SRM2466RG26	24 x 66 x 29	150	125.50	30.38	\$862	
SRM2472RG26	24 x 72 x 29	150	140	33.08	\$877	

- SRM24xxRG18 has an 18" modesty panel
- SRM24xxRG26 has a 26" modesty panel

Required Specifications

Top Finish
Body Finish

Optional Specifications

Grommet
HP laminate

RETURNS

MODEL# DIMENSIONS FREIGHT CLASS WT/LBS. CUBIC FT. LIST PRICE HP ADD

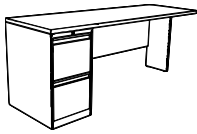

18" modesty

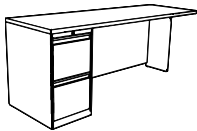

26" modesty

Return - Left

D x W x H						
SRM2430LF18	24 x 30 x 29	100	117.50	14.18		\$921
SRM2436LF18	24 x 36 x 29	125	123	16.88		\$949
SRM2442LF18	24 x 42 x 29	125	128.50	19.58		\$979
SRM2448LF18	24 x 48 x 29	150	135	24		\$1008
SRM2454LF18	24 x 54 x 29	150	147.50	24.98		\$1036
SRM2460LF18	24 x 60 x 29	150	153	27.68		\$1066
SRM2466LF18	24 x 66 x 29	150	158	30.38		\$1084
SRM2472LF18	24 x 72 x 29	150	172	33.08		\$1097
SRM2430LF26	24 x 30 x 29	100	120	14.18		\$926
SRM2436LF26	24 x 36 x 29	125	126	16.88		\$957
SRM2442LF26	24 x 42 x 29	125	132	19.58		\$987
SRM2448LF26	24 x 48 x 29	125	138	22.28		\$1017
SRM2454LF26	24 x 54 x 29	125	152	24.98		\$1048
SRM2460LF26	24 x 60 x 29	150	157.90	27.68		\$1077
SRM2466LF26	24 x 66 x 29	150	163	30.38		\$1097
SRM2472LF26	24 x 72 x 29	150	178	33.08		\$1113

Standard with full to floor **file/file** pedestal on **left**. Pedestal lock.

- SRM24xxLF18 has an 18" modesty panel
- SRM24xxLF26 has a 26" modesty panel



18" modesty

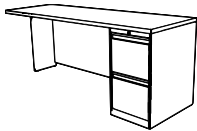

26" modesty

Return - Right

SRM2430RF18	24 x 30 x 29	100	117.50	14.18		\$921
SRM2436RF18	24 x 36 x 29	125	123	16.88		\$949
SRM2442RF18	24 x 42 x 29	125	128.50	19.58		\$979
SRM2448RF18	24 x 48 x 29	150	135	24		\$1008
SRM2454RF18	24 x 54 x 29	150	147.50	24.98		\$1036
SRM2460RF18	24 x 60 x 29	150	153	27.68		\$1066
SRM2466RF18	24 x 66 x 29	150	158	30.38		\$1084
SRM2472RF18	24 x 72 x 29	150	172	33.08		\$1097
SRM2430RF26	24 x 30 x 29	100	120	14.18		\$926
SRM2436RF26	24 x 36 x 29	125	126	16.88		\$957
SRM2442RF26	24 x 42 x 29	125	132	19.58		\$987
SRM2448RF26	24 x 48 x 29	125	138	22.28		\$1017
SRM2454RF26	24 x 54 x 29	125	152	24.98		\$1048
SRM2460RF26	24 x 60 x 29	150	157.90	27.68		\$1077
SRM2466RF26	24 x 66 x 29	150	163	30.38		\$1097
SRM2472RF26	24 x 72 x 29	150	178	33.08		\$1113

Standard with full to floor **file/file** pedestal on **right**. Pedestal lock.

- SRM24xxRF18 has an 18" modesty panel
- SRM24xxRF26 has a 26" modesty panel.

Required Specifications

Top Finish
Body Finish

Optional Specifications

Grommet
HP laminate

RETURNS



18" modesty



26" modesty

Return - Left

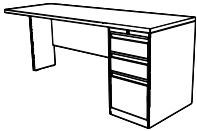

18" modesty



26" modesty

Return - Right

MODEL#	DIMENSIONS	FREIGHT CLASS	WT/LBS.	CUBIC FT.	LIST PRICE	HP ADD
--------	------------	---------------	---------	-----------	------------	--------

D x W x H

SRM2430LB18	24 x 30 x 29	100	117.50	14.18	\$921	
SRM2436LB18	24 x 36 x 29	125	123	16.88	\$949	
SRM2442LB18	24 x 42 x 29	125	128.50	19.58	\$979	
SRM2448LB18	24 x 48 x 29	150	135	24	\$1008	
SRM2454LB18	24 x 54 x 29	150	147.50	24.98	\$1036	
SRM2460LB18	24 x 60 x 29	150	153	27.68	\$1066	
SRM2466LB18	24 x 66 x 29	150	158	30.38	\$1084	
SRM2472LB18	24 x 72 x 29	150	172	33.08	\$1097	
SRM2430LB26	24 x 30 x 29	100	120	14.18	\$926	
SRM2436LB26	24 x 36 x 29	125	126	16.88	\$957	
SRM2442LB26	24 x 42 x 29	125	132	19.58	\$987	
SRM2448LB26	24 x 48 x 29	125	138	22.28	\$1017	
SRM2454LB26	24 x 54 x 29	125	152	24.98	\$1048	
SRM2460LB26	24 x 60 x 29	150	157.90	27.68	\$1077	
SRM2466LB26	24 x 66 x 29	150	163	30.38	\$1097	
SRM2472LB26	24 x 72 x 29	150	178	33.08	\$1113	

Standard with full to floor **box/box/file** pedestal on **left**. Pedestal lock. One pencil tray.

- SRM24xxLB18 has an 18" modesty panel
- SRM24xxLB26 has a 26" modesty panel.

SRM2430RB18	24 x 30 x 29	100	117.50	14.18	\$921	
SRM2436RB18	24 x 36 x 29	125	123	16.88	\$949	
SRM2442RB18	24 x 42 x 29	125	128.50	19.58	\$979	
SRM2448RB18	24 x 48 x 29	150	135	24	\$1008	
SRM2454RB18	24 x 54 x 29	150	147.50	24.98	\$1036	
SRM2460RB18	24 x 60 x 29	150	153	27.68	\$1066	
SRM2466RB18	24 x 66 x 29	150	158	30.38	\$1084	
SRM2472RB18	24 x 72 x 29	150	172	33.08	\$1097	
SRM2430RB26	24 x 30 x 29	100	120	14.18	\$926	
SRM2436RB26	24 x 36 x 29	125	126	16.88	\$957	
SRM2442RB26	24 x 42 x 29	125	132	19.58	\$987	
SRM2448RB26	24 x 48 x 29	125	138	22.28	\$1017	
SRM2454RB26	24 x 54 x 29	125	152	24.98	\$1048	
SRM2460RB26	24 x 60 x 29	150	157.90	27.68	\$1077	
SRM2466RB26	24 x 66 x 29	150	163	30.38	\$1097	
SRM2472RB26	24 x 72 x 29	150	178	33.08	\$1113	

Standard with full to floor **box/box/file** pedestal on **right**. Pedestal lock. One pencil tray.

- SRM24xxRB18 has an 18" modesty panel
- SRM24xxRB26 has a 26" modesty panel

Required Specifications

Top Finish
Body Finish

Optional Specifications

Grommet
HP laminate

RETURNS

MODEL# DIMENSIONS FREIGHT CLASS WT/LBS. CUBIC FT. LIST PRICE HP ADD

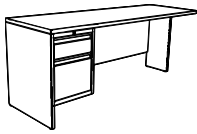

20" modesty



26" modesty

Return - Left



20" modesty

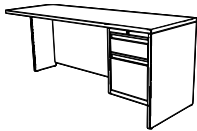

26" modesty

Return - Right

D x W x H

SRM2430LH20	24 x 30 x 29	100	119.50	14.18	\$901
SRM2436LH20	24 x 36 x 29	125	125	16.88	\$930
SRM2442LH20	24 x 42 x 29	125	130.50	19.58	\$958
SRM2448LH20	24 x 48 x 29	125	136	22.28	\$987
SRM2454LH20	24 x 54 x 29	150	149.50	24.98	\$1016
SRM2460LH20	24 x 60 x 29	150	155	27.68	\$1045
SRM2466LH20	24 x 66 x 29	150	160	30.38	\$1064
SRM2472LH20	24 x 72 x 29	150	174	33.08	\$1077

SRM2430LH26	24 x 30 x 29	100	122	14.18	\$907
SRM2436LH26	24 x 36 x 29	125	128	16.88	\$938
SRM2442LH26	24 x 42 x 29	125	134	19.58	\$968
SRM2448LH26	24 x 48 x 29	125	140	22.28	\$998
SRM2454LH26	24 x 54 x 29	125	154	24.98	\$1027
SRM2460LH26	24 x 60 x 29	150	160	27.68	\$1057
SRM2466LH26	24 x 66 x 29	150	165	30.38	\$1077
SRM2472LH26	24 x 72 x 29	150	180	33.08	\$1092

Standard with **box/file** pedestal on **left**. Pedestal lock. One pencil tray.

- SRM24xxLH20 has a 20" modesty panel
- SRM24xxLH26 has a 26" modesty panel

SRM2430RH20	24 x 30 x 29	100	119.50	14.18	\$901
SRM2436RH20	24 x 36 x 29	125	125	16.88	\$930
SRM2442RH20	24 x 42 x 29	125	130.50	19.58	\$958
SRM2448RH20	24 x 48 x 29	125	136	22.28	\$987
SRM2454RH20	24 x 54 x 29	150	149.50	24.98	\$1016
SRM2460RH20	24 x 60 x 29	150	155	27.68	\$1045
SRM2466RH20	24 x 66 x 29	150	160	30.38	\$1064
SRM2472RH20	24 x 72 x 29	150	174	33.08	\$1077

SRM2430RH26	24 x 30 x 29	100	122	14.18	\$907
SRM2436RH26	24 x 36 x 29	125	128	16.88	\$938
SRM2442RH26	24 x 42 x 29	125	134	19.58	\$968
SRM2448RH26	24 x 48 x 29	125	140	22.28	\$998
SRM2454RH26	24 x 54 x 29	125	154	24.98	\$1027
SRM2460RH26	24 x 60 x 29	150	160	27.68	\$1057
SRM2466RH26	24 x 66 x 29	150	165	30.38	\$1077
SRM2472RH26	24 x 72 x 29	150	180	33.08	\$1092

Standard with **box/file** pedestal on **right**. Pedestal lock. One pencil tray.

- SRM24xxRH20 has a 20" modesty panel
- SRM24xxRH26 has a 26" modesty panel

Required Specifications

Top Finish
Body Finish

Optional Specifications

Grommet
HP laminate

SPACE SAVER RETURNS

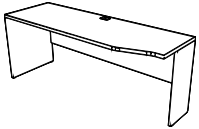

18" modesty

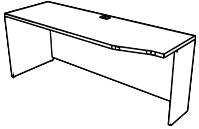

26" modesty

24" D Space Saver Return, Left

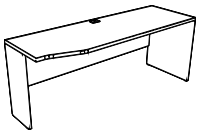

18" modesty

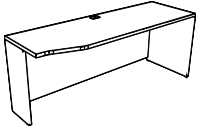

26" modesty

24" D Space Saver Return, Right

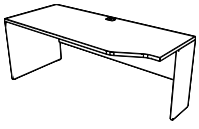

18" modesty

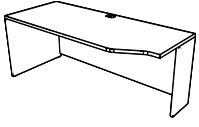

26" modesty

30" D Space Saver Return, Left

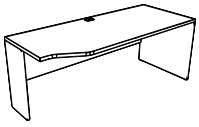

18" modesty

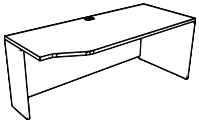

26" modesty

30" D Space Saver Return, Right

MODEL#	DIMENSIONS	FREIGHT CLASS	WT./LBS.	CUBIC FT.	LIST PRICE HP ADD
--------	------------	---------------	----------	-----------	-------------------

D x W x H

SDM244820LK18	24 x 48 x 29	150	94.50	22.28	\$949
SDM245420LK18	24 x 54 x 29	150	108	24.98	\$965
SDM246020LK18	24 x 60 x 29	150	113.50	27.68	\$980
SDM246620LK18	24 x 66 x 29	250	118	30.38	\$1009
SDM247220LK18	24 x 72 x 29	150	132.50	33.08	\$1043
SDM244820LK26	24 x 48 x 29	150	98	22.28	\$963
SDM245420LK26	24 x 54 x 29	150	112	24.98	\$978
SDM246020LK26	24 x 60 x 29	150	118	27.68	\$992
SDM246620LK26	24 x 66 x 29	150	123.50	30.38	\$1022
SDM247220LK26	24 x 72 x 29	150	138	33.08	\$1057

Connects to **20" D 5-sided** corner unit. Grommet in worksurface.

- SDM24xx20LK18 has an 18" modesty panel
- SDM24xx20LK26 has a 26" modesty panel

SDM244820RK18	24 x 48 x 29	150	94.50	22.28	\$949
SDM245420RK18	24 x 54 x 29	150	108	24.98	\$965
SDM246020RK18	24 x 60 x 29	150	113.50	27.68	\$980
SDM246620RK18	24 x 66 x 29	250	118	30.38	\$1009
SDM247220RK18	24 x 72 x 29	150	132.50	33.08	\$1043
SDM244820RK26	24 x 48 x 29	150	98	22.28	\$963
SDM245420RK26	24 x 54 x 29	150	112	24.98	\$978
SDM246020RK26	24 x 60 x 29	150	118	27.68	\$992
SDM246620RK26	24 x 66 x 29	150	123.50	30.38	\$1022
SDM247220RK26	24 x 72 x 29	150	138	33.08	\$1057

Connects to **20" D 5-sided** corner unit. Grommet in worksurface.

- SDM24xx20RK18 has an 18" modesty panel
- SDM24xx20RK26 has a 26" modesty panel

SDM306024LK18	24 x 60 x 29	150	142	34.19	\$1020
SDM306624LK18	24 x 66 x 29	150	151.50	37.53	\$1048
SDM307224LK18	24 x 72 x 29	250	163	40.87	\$1122
SDM306024LK26	24 x 60 x 29	150	146.50	34.19	\$1033
SDM306624LK26	24 x 66 x 29	150	158	37.53	\$1062
SDM307224LK26	24 x 72 x 29	150	169	40.87	\$1138

Connects to **24" D 5-sided** corner unit. Grommet in worksurface.

- SDM30xx24LK18 has an 18" modesty panel
- SDM30xx24LK26 has a 26" modesty panel

SDM306024RK18	24 x 60 x 29	150	142	34.19	\$1020
SDM306624RK18	24 x 66 x 29	150	151.50	37.53	\$1048
SDM307224RK18	24 x 72 x 29	250	163	40.87	\$1122
SDM306024RK26	24 x 60 x 29	150	146.50	34.19	\$1033
SDM306624RK26	24 x 66 x 29	150	158	37.53	\$1062
SDM307224RK26	24 x 72 x 29	150	169	40.87	\$1138

Connects to **24" D 5-sided** corner unit. Grommet in worksurface.

- SDM30xx24RK18 has an 18" modesty panel
- SDM30xx24RK26 has a 26" modesty panel

Required Specifications

Top Finish
Body Finish

Optional Specifications

Grommet
HP laminate

SPACE SAVER RETURNS

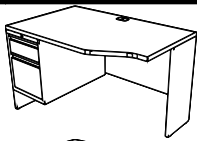

20" modesty

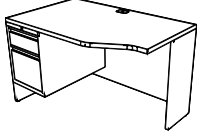

26" modesty

30" D Space Saver Return, Left

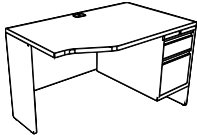

20" modesty

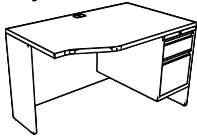

26" modesty

30" D Space Saver Return, Right

MODEL#	DIMENSIONS	FREIGHT CLASS	WT./LBS.	CUBIC FT.	LIST PRICE	HP ADD
D x W x H						
SDM304824HLK20	24 x 48 x 29	150	147.50	27.50	\$1337	
SDM304824HLK26	24 x 48 x 29	150	151.50	27.50	\$1348	

Standard with **box/file** pedestal on **left**. Pedestal lock. One pencil tray.

- SDM304824HLK20 has a 20" modesty panel
- SDM304824HLK26 has a 26" modesty panel

SDM304824HRK20	24 x 48 x 29	150	147.50	27.50	\$1337	
SDM304824HRK26	24 x 48 x 29	150	151.50	27.50	\$1348	

Standard with **box/file** pedestal on **right**. Pedestal lock. One pencil tray.

- SDM304824HRK20 has a 20" modesty panel
- SDM304824HRK26 has a 26" modesty panel

DOUBLE PEDESTAL CRENZAS

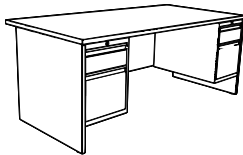

20" modesty



26" modesty

Double Pedestal Credenza



18" modesty



26" modesty

Double Pedestal Credenza

SDM2448HH20	24 x 48 x 29	100	188	22.28	\$1433	
SDM2454HH20	24 x 54 x 29	100	201.50	24.98	\$1462	
SDM2460HH20	24 x 60 x 29	125	207	27.68	\$1490	
SDM2466HH20	24 x 66 x 29	125	211.50	30.38	\$1509	
SDM2472HH20	24 x 72 x 29	125	226	33.08	\$1523	

SDM2448HH26	24 x 48 x 29	100	192	22.28	\$1442	
SDM2454HH26	24 x 54 x 29	100	206	24.98	\$1473	
SDM2460HH26	24 x 60 x 29	125	212	27.68	\$1503	
SDM2466HH26	24 x 66 x 29	125	217	30.38	\$1523	
SDM2472HH26	24 x 72 x 29	125	232	33.08	\$1538	

Standard with **box/file** pedestals on both sides. Pedestal locks. One pencil tray.

- SDM24xxHH20 has a 20" modesty panel
- SDM24xxHH26 has a 26" modesty panel

SDM2448BB18	24 x 48 x 29	100	184	22.28	\$1313	
SDM2454BB18	24 x 54 x 29	125	197.50	24.98	\$1342	
SDM2460BB18	24 x 60 x 29	125	203	27.68	\$1370	
SDM2466BB18	24 x 66 x 29	125	208	30.38	\$1390	
SDM2472BB18	24 x 72 x 29	125	222	33.08	\$1402	

SDM2448BB26	24 x 48 x 29	100	188	22.28	\$1323	
SDM2454BB26	24 x 54 x 29	100	202	24.98	\$1353	
SDM2460BB26	24 x 60 x 29	125	208	27.68	\$1383	
SDM2466BB26	24 x 66 x 29	125	213	30.38	\$1402	
SDM2472BB26	24 x 72 x 29	125	228	33.08	\$1418	

Standard with full to floor **box/box/file** pedestals on both sides. Pedestal locks. One pencil tray.

- SDM24xxBB18 has an 18" modesty panel
- SDM24xxBB26 has a 26" modesty panel

Required Specifications

Top Finish
Body Finish

Optional Specifications

Grommet
HP laminate

DOUBLE PEDESTAL DESKS

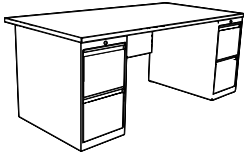

18" modesty

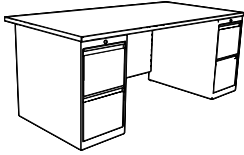

26" modesty

Double Pedestal Credenza

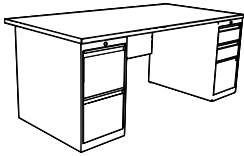

18" modesty

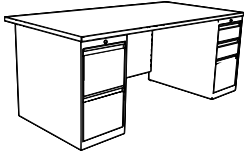

26" modesty

Double Pedestal Credenza

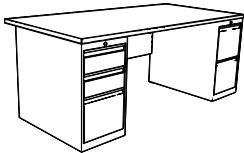

18" modesty

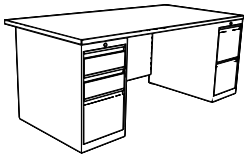

26" modesty

Double Pedestal Credenza

MODEL#	DIMENSIONS	FREIGHT CLASS	WT/LBS.	CUBIC FT.	LIST PRICE	HP ADD
--------	------------	---------------	---------	-----------	------------	--------

D x W x H

SDM2448FF18	24 x 48 x 29	100	184	22.28	\$1313	
SDM2454FF18	24 x 54 x 29	125	197.50	24.98	\$1342	
SDM2460FF18	24 x 60 x 29	125	203	27.68	\$1370	
SDM2466FF18	24 x 66 x 29	125	208	30.38	\$1390	
SDM2472FF18	24 x 72 x 29	125	222	33.08	\$1402	
SDM2448FF26	24 x 48 x 29	100	188	22.28	\$1323	
SDM2454FF26	24 x 54 x 29	100	202	24.98	\$1353	
SDM2460FF26	24 x 60 x 29	125	208	27.68	\$1383	
SDM2466FF26	24 x 66 x 29	125	213	30.38	\$1402	
SDM2472FF26	24 x 72 x 29	125	228	33.08	\$1418	

Standard with full to floor **file/file** pedestals on both sides. Pedestal locks.

- SDM24xxFF18 has an 18" modesty panel
- SDM24xxFF26 has a 26" modesty panel

SDM2448FB18	24 x 48 x 29	100	184	22.28	\$1313	
SDM2454FB18	24 x 54 x 29	125	197.50	24.98	\$1342	
SDM2460FB18	24 x 60 x 29	125	203	27.68	\$1370	
SDM2466FB18	24 x 66 x 29	125	208	30.38	\$1390	
SDM2472FB18	24 x 72 x 29	125	222	33.08	\$1402	

SDM2448FB26	24 x 48 x 29	100	188	22.28	\$1323	
SDM2454FB26	24 x 54 x 29	100	202	24.98	\$1353	
SDM2460FB26	24 x 60 x 29	125	208	27.68	\$1383	
SDM2466FB26	24 x 66 x 29	125	213	30.38	\$1402	
SDM2472FB26	24 x 72 x 29	125	228	33.08	\$1418	

Standard with full to floor **file/file** pedestal on **left** and **box/box/file** pedestal on **right**. Pedestal locks. One pencil tray.

- SDM24xxFB18 has an 18" modesty panel
- SDM24xxFB26 has a 26" modesty panel.

SDM2448BF18	24 x 48 x 29	100	184	22.28	\$1313	
SDM2454BF18	24 x 54 x 29	125	197.50	24.98	\$1342	
SDM2460BF18	24 x 60 x 29	125	203	27.68	\$1370	
SDM2466BF18	24 x 66 x 29	125	208	30.38	\$1390	
SDM2472BF18	24 x 72 x 29	125	222	33.08	\$1402	

SDM2448BF26	24 x 48 x 29	100	188	22.28	\$1323	
SDM2454BF26	24 x 54 x 29	100	202	24.98	\$1353	
SDM2460BF26	24 x 60 x 29	125	208	27.68	\$1383	
SDM2466BF26	24 x 66 x 29	125	213	30.38	\$1402	
SDM2472BF26	24 x 72 x 29	125	228	33.08	\$1418	

Standard with full to floor **file/file** pedestal on **right** and **box/box/file** pedestal on **left**. Pedestal locks. One pencil tray.

- SDM24xxBF18 has an 18" modesty panel
- SDM24xxBF26 has a 26" modesty panel

Required Specifications

Top Finish
Body Finish

Optional Specifications

Grommet
HP laminate

SINGLE PEDESTAL CREDENZAS



18" modesty



26" modesty

Single Pedestal Credenza - Left

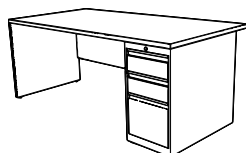

18" modesty



26" modesty

Single Pedestal Credenza - Right

MODEL# DIMENSIONS FREIGHT CLASS WT/LBS. CUBIC FT. LIST PRICE HP ADD

D x W x H

SDM2442BG18	24 x 42 x 29	125	140.50	19.58	\$1028
SDM2448BG18	24 x 48 x 29	125	146	22.28	\$1057
SDM2454BG18	24 x 54 x 29	125	160	24.98	\$1086
SDM2460BG18	24 x 60 x 29	150	165	27.68	\$1115
SDM2466BG18	24 x 66 x 29	150	170	30.38	\$1133
SDM2472BG18	24 x 72 x 29	150	184	33.08	\$1147

SDM2442BG26	24 x 42 x 29	125	144	19.58	\$1037
SDM2448BG26	24 x 48 x 29	125	150	22.28	\$1068
SDM2454BG26	24 x 54 x 29	125	164	24.98	\$1097
SDM2460BG26	24 x 60 x 29	125	170	27.68	\$1128
SDM2466BG26	24 x 66 x 29	150	175	30.38	\$1147
SDM2472BG26	24 x 72 x 29	150	190	33.08	\$1162

Standard with full to floor **box/box/file** pedestal on **left**. Pedestal lock. One pencil tray.

- SDM24xxBG18 has an 18" modesty panel
- SDM24xxBG26 has a 26" modesty panel

SDM2442GB18	24 x 42 x 29	125	140.50	19.58	\$1028
SDM2448GB18	24 x 48 x 29	125	146	22.28	\$1057
SDM2454GB18	24 x 54 x 29	125	160	24.98	\$1086
SDM2460GB18	24 x 60 x 29	150	165	27.68	\$1115
SDM2466GB18	24 x 66 x 29	150	170	30.38	\$1133
SDM2472GB18	24 x 72 x 29	150	184	33.08	\$1147

SDM2442GB26	24 x 42 x 29	125	144	19.58	\$1037
SDM2448GB26	24 x 48 x 29	125	150	22.28	\$1068
SDM2454GB26	24 x 54 x 29	125	164	24.98	\$1097
SDM2460GB26	24 x 60 x 29	125	170	27.68	\$1128
SDM2466GB26	24 x 66 x 29	150	175	30.38	\$1147
SDM2472GB26	24 x 72 x 29	150	190	33.08	\$1162

Standard with full to floor **box/box/file** pedestal on **right**. Pedestal lock. One pencil tray.

- SDM24xxGB18 has an 18" modesty panel
- SDM24xxGB26 has a 26" modesty panel

Required Specifications

Top Finish
Body Finish

Optional Specifications

Grommet
HP laminate

SINGLE PEDESTAL CREDENZAS

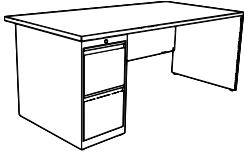

18" modesty

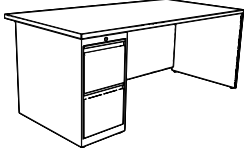

26" modesty

Single Pedestal Credenza - Left

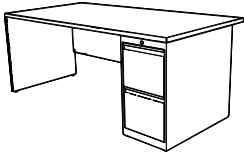

18" modesty

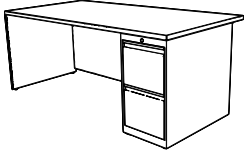

26" modesty

Single Pedestal Credenza - Right

MODEL#	DIMENSIONS	FREIGHT CLASS	WT/LBS.	CUBIC FT.	LIST PRICE	HP ADD
--------	------------	---------------	---------	-----------	------------	--------

D x W x H

SDM2442FG18	24 x 42 x 29	125	140.50	19.58	\$1028	
SDM2448FG18	24 x 48 x 29	125	146	22.28	\$1057	
SDM2454FG18	24 x 54 x 29	125	160	24.98	\$1086	
SDM2460FG18	24 x 60 x 29	150	165	27.68	\$1115	
SDM2466FG18	24 x 66 x 29	150	170	30.38	\$1133	
SDM2472FG18	24 x 72 x 29	150	184	33.08	\$1147	
SDM2442FG26	24 x 42 x 29	125	144	19.58	\$1037	
SDM2448FG26	24 x 48 x 29	125	150	22.28	\$1068	
SDM2454FG26	24 x 54 x 29	125	164	24.98	\$1097	
SDM2460FG26	24 x 60 x 29	125	170	27.68	\$1128	
SDM2466FG26	24 x 66 x 29	150	165.50	30.38	\$1147	
SDM2472FG26	24 x 72 x 29	150	190	33.08	\$1162	

Standard with full to floor **file/file** pedestal on **left**. Pedestal lock. One pencil tray.

- SDM24xxFG18 has an 18" modesty panel
- SDM24xxFG26 has a 26" modesty panel

SDM2442GF18	24 x 42 x 29	125	140.50	19.58	\$1028	
SDM2448GF18	24 x 48 x 29	125	146	22.28	\$1057	
SDM2454GF18	24 x 54 x 29	125	160	24.98	\$1086	
SDM2460GF18	24 x 60 x 29	150	165	27.68	\$1115	
SDM2466GF18	24 x 66 x 29	150	170	30.38	\$1133	
SDM2472GF18	24 x 72 x 29	150	184	33.08	\$1147	
SDM2442GF26	24 x 42 x 29	125	144	19.58	\$1037	
SDM2448GF26	24 x 48 x 29	125	150	22.28	\$1068	
SDM2454GF26	24 x 54 x 29	125	164	24.98	\$1097	
SDM2460GF26	24 x 60 x 29	125	170	27.68	\$1128	
SDM2466GF26	24 x 66 x 29	150	175	30.38	\$1147	
SDM2472GF26	24 x 72 x 29	150	190	33.08	\$1162	

Standard with full to floor **file/file** pedestal on **right**. Pedestal lock. One pencil tray.

- SDM24xxGF18 has an 18" modesty panel
- SDM24xxGF26 has a 26" modesty panel

Required Specifications

Top Finish
Body Finish

Optional Specifications

Grommet
HP laminate

SINGLE PEDESTAL CREDENZAS

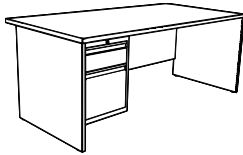

20" modesty

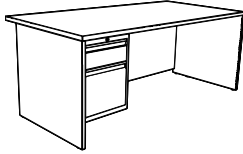

26" modesty

Single Pedestal Credenza - Left

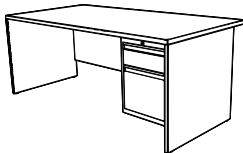

20" modesty

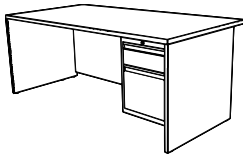

26" modesty

Single Pedestal Credenza - Right

MODEL# DIMENSIONS FREIGHT CLASS WT/LBS. CUBIC FT. LIST PRICE HP ADD

D x W x H

SDM2442HG20	24 x 42 x 29	125	143	19.58	\$1089
SDM2448HG20	24 x 48 x 29	125	148	22.28	\$1117
SDM2454HG20	24 x 54 x 29	125	161.50	24.98	\$1146
SDM2460HG20	24 x 60 x 29	125	167	27.68	\$1176
SDM2466HG20	24 x 66 x 29	150	172	30.38	\$1194
SDM2472HG20	24 x 72 x 29	150	186	33.08	\$1208

SDM2442HG26	24 x 42 x 29	125	146	19.58	\$1097
SDM2448HG26	24 x 48 x 29	125	152	22.28	\$1128
SDM2454HG26	24 x 54 x 29	125	166	24.98	\$1157
SDM2460HG26	24 x 60 x 29	125	172	27.68	\$1187
SDM2466HG26	24 x 66 x 29	150	177	30.38	\$1208
SDM2472HG26	24 x 72 x 29	150	192	33.08	\$1223

Standard with **box/file** pedestal on **left**. Pedestal lock. One pencil tray.

- SDM24xxHG20 has a 20" modesty panel
- SDM24xxHG26 has a 26" modesty panel

SDM2442GH20	24 x 42 x 29	125	143	19.58	\$1089
SDM2448GH20	24 x 48 x 29	125	148	22.28	\$1117
SDM2454GH20	24 x 54 x 29	125	161.50	24.98	\$1146
SDM2460GH20	24 x 60 x 29	125	167	27.68	\$1176
SDM2466GH20	24 x 66 x 29	150	172	30.38	\$1194
SDM2472GH20	24 x 72 x 29	150	186	33.08	\$1208

SDM2442GH26	24 x 42 x 29	125	146	19.58	\$1097
SDM2448GH26	24 x 48 x 29	125	152	22.28	\$1128
SDM2454GH26	24 x 54 x 29	125	166	24.98	\$1157
SDM2460GH26	24 x 60 x 29	125	172	27.68	\$1187
SDM2466GH26	24 x 66 x 29	150	177	30.38	\$1208
SDM2472GH26	24 x 72 x 29	150	192	33.08	\$1223

Standard with **box/file** pedestal on **right**. Pedestal lock. One pencil tray.

- SDM24xxGH20 has a 20" modesty panel
- SDM24xxGH26 has a 26" modesty panel

Required Specifications

Top Finish
Body Finish

Optional Specifications

Grommet
HP laminate

S STREAMLINE II™

CREDENZAS

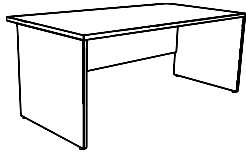

18" modesty

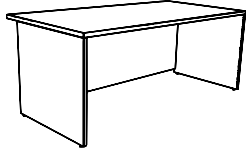

26" modesty

Credenza Shell*

MODEL#	DIMENSIONS D x W x H	FREIGHT CLASS	WT./LBS.	CUBIC FT.	LIST PRICE	HP ADD
SDM2442GG18	24 x 42 x 29	150	103	19.58	\$773	
SDM2448GG18	24 x 48 x 29	150	108	22.28	\$803	
SDM2454GG18	24 x 54 x 29	150	122	24.98	\$831	
SDM2460GG18	24 x 60 x 29	150	127.50	27.68	\$860	
SDM2466GG18	24 x 66 x 29	150	170	30.38	\$878	
SDM2472GG18	24 x 72 x 29	150	146.50	33.08	\$892	
SDM2442GG26	24 x 42 x 29	150	106	19.58	\$782	
SDM2448GG26	24 x 48 x 29	150	112	22.28	\$812	
SDM2454GG26	24 x 54 x 29	150	126	24.98	\$842	
SDM2460GG26	24 x 60 x 29	150	132	27.68	\$873	
SDM2466GG26	24 x 66 x 29	150	175	30.38	\$892	
SDM2472GG26	24 x 72 x 29	150	152	33.08	\$907	

- SDM24xxGG18 has an 18" modesty panel
- SDM24xxGG26 has a 26" modesty panel

HUTCHES

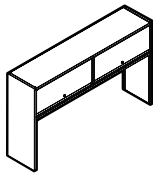

Closed Hutch with Open Back

SH1572	15 x 72 x 39	125	115	14.50	\$933
SH1566	15 x 66 x 39	100	110	13	\$905
SH1560	15 x 60 x 39	100	105	12	\$873
SH1548	15 x 48 x 39	100	95	10	\$844
SH1542	15 x 42 x 39	100	85	9	\$808
SH1536	15 x 36 x 39	92.5	75	7.50	\$787

Hutch with two receding doors and one fixed shelf divider. **ALL METAL.** Doors lock. Not slotted for plate dividers. Shipped RTA (ready to assemble).

- Models SH1542/SH1536 use a single receding door and no shelf divider.

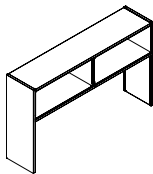

Open Hutch with Open Back

SH1572ND	15 x 72 x 39.62	125	115	14.50	\$789
SH1566ND	15 x 66 x 39.62	100	115	13	\$766
SH1560ND	15 x 60 x 39.62	100	115	12	\$740
SH1548ND	15 x 48 x 39.62	92.5	115	10	\$723
SH1542ND	15 x 42 x 39.62	85	115	9	\$685
SH1536ND	15 x 36 x 39.62	70	115	7.50	\$668

One fixed shelf and one fixed shelf divider. **ALL METAL.** Not slotted for plate dividers. Shipped RTA (ready to assemble).

BACK PANELS

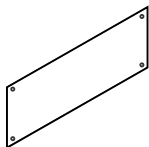

Back Panel

SHM72	.75 x 72 x 24	65	33	1.30	\$450
SHM66	.75 x 66 x 24	65	31	1.20	\$429
SHM60	.75 x 60 x 24	65	28	1	\$408
SHM48	.75 x 48 x 24	60	24	.80	\$371
SHM42	.75 x 42 x 24	65	21	.75	\$355
SHM36	.75 x 36 x 24	60	19	.60	\$339

For StreamLINE Series Hutches Only. **ALL METAL.**

Required Specifications

Top Finish
Body Finish

Optional Specifications

Grommet*
HP laminate*

TACKBOARDS FOR HUTCHES

MODEL# DIMENSIONS FREIGHT CLASS WT/LBS. CUBIC FT. FABRIC GRADE LIST PRICE

D x W x H

BACK PANEL Notes: Tackboards can be upholstered in all of the following fabrics:

Grade 1: Agate II, Hudson, Jenny, Quilt, Terrace, Urban, Waterfall

Grade 2: Crescent, Imprint, Lola, Match, Renewal, Replay, Silhouette

Grade 3: Anchorage, Brinx, Mariposa, Merge

Grade 4: Accent

Grade 5: Meander, Tracery, Universe

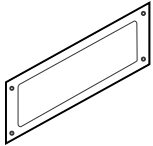

Back Panel

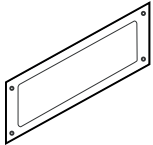

Back Panel

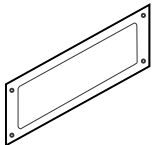

Back Panel

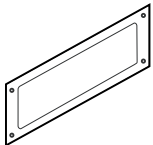

Back Panel

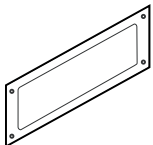

Back Panel

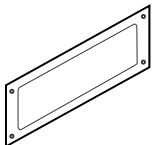

Back Panel

SHMTB72	.75 x 72 x 24	65	33	1.30	1	\$544
					2	\$602
					3	\$660
					4	\$727
					5	\$807

For StreamLINE Series Hutches Only. **ALL METAL** with tackboard.

SHMTB66	.75 x 66 x 24	65	31	1.20	1	\$515
					2	\$567
					3	\$620
					4	\$679
					5	\$754

For StreamLINE Series Hutches Only. **ALL METAL** with tackboard.

SHMTB60	.75 x 60 x 24	65	28	1	1	\$487
					2	\$534
					3	\$579
					4	\$635
					5	\$700

For StreamLINE Series Hutches Only. **ALL METAL** with tackboard.

SHMTB48	.75 x 48 x 24	60	24	.80	1	\$439
					2	\$474
					3	\$509
					4	\$552
					5	\$590

For StreamLINE Series Hutches Only. **ALL METAL** with tackboard.

SHMTB42	.75 x 42 x 24	65	21	.75	1	\$416
					2	\$446
					3	\$479
					4	\$519
					5	\$565

For StreamLINE Series Hutches Only. **ALL METAL** with tackboard.

SHMTB36	.75 x 36 x 24	60	19	.60	1	\$392
					2	\$420
					3	\$449
					4	\$485
					5	\$527

For StreamLINE Series Hutches Only. **ALL METAL** with tackboard.

Required Specifications

- Paint finish
- Fabric

PEDESTALS

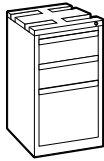

Box/Box/File Pedestal

MODEL#	DIMENSIONS D x W x H	FREIGHT CLASS	WT./LBS.	CUBIC FT.	LIST PRICE
GW PSS18BBF	18 x 15 x 27.62	70	76	4.80	\$501
GW PSS24BBF	24 x 15 x 27.62	85	84	5.80	\$510
GW PSS30BBF	30 x 15 x 27.62	85	94	7.30	\$522

Two box and 1 file drawer pedestal.

- **Cannot be used with 66" w Streamline Extended Corners**

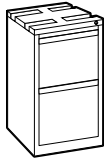

File/File Pedestal

GW PSS18FF	18 x 15 x 27.62	70	76	4.80	\$501
GW PSS24FF	24 x 15 x 27.62	85	84	5.80	\$510
GW PSS30FF	30 x 15 x 27.62	85	97	7.30	\$522

Two file drawer pedestal.

- **Cannot be used with 66" w Streamline Extended Corners**

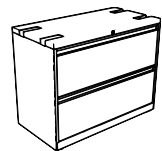

2 Drawer Lateral File - Fixed Front Worksurface supporting

1230P2FFDAO	18 x 30 x 27.75	125	69.29	10	\$772
1236P2FFDAO	18 x 36 x 27.75	125	86	12.38	\$787
1242P2FFDAO	18 x 42 x 27.75	125	105	14.36	\$812

Two fixed front drawers. Side-to-side hanging file bars included.

ACCESSORIES

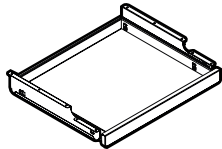

Center Drawer

SDMCD	16.75 x 20 x 1.75	100	8	1	\$140
-------	-------------------	-----	---	---	--------------

Metal drawer front is attached to a 4-sided frame. All Metal.

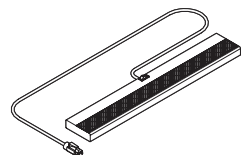

Task Light

PVET5L48	4.25 x 48 x 1.25	65	8	.28	\$192
PVET5L36	4.25 x 36 x 1.25	65	6	.21	\$174
PVET5L24	4.25 x 24 x 1.25	65	4	.15	\$160
PVET5L18	4.25 x 19.5 x 1.25	65	3	.12	\$154

SHTSLB1	--	70	1	.07	\$47
---------	----	----	---	-----	-------------

T5 rapid start fluorescent lamp provides energy-efficient illumination. Slim low profile metal chassis. Electronic ballast. Prismatic acrylic lens included. Attaches to wood or metal units. 9' power cord. Specify 6" shorter than storage unit width.

- When hanging task lights on the underside of steel hutch, the **SHTSLB1** bracket set **MUST BE USED**.

Replacement bulbs for the task light are as follows:

24" - 14W T5 22" soft white

36" - 21W T5 34" soft white

48" - 28W T5 46" neutral

Required Specifications

Top Finish
Body Finish

Optional Specifications

Grommet

benching



Bridges II

338



Sidebar

434





bridges II connect
share
achieve

Our desire was to develop an environment for collaborative teamwork which would facilitate connection, or bridging of people and ideas. A set of components which would even serve as a catalyst, inviting team members out of their cocooned comfort zones and encouraging them to engage, co-create. With Bridges II you can develop an environment of collaborative teamwork through workspace configuration that enhances line communication and bridges people with a spectrum of ideas and interfaces. Bridges II features a set of components that facilitate communication and streamline interaction through product that efficiently adapts and creatively configures. The product focuses on advancing engagement and collaborative creation through quick adaptations necessary to meet the needs of a fast paced and ever changing work environment. With flexible building components, Bridges II fits numerous applications, from boardrooms to multi-person workstations. It is easy to customize and reconfigure to fit specific requirements.



Features and Benefits

- High performance thermally fused laminate tops are 1" thick
- High pressure laminate tops are 1-1/16" thick
- Flat 3mm edge profile on all sides
- Worksurfaces provided with pilot holes for alignment
- Numerous Power/Data accessories
- Interconnected storage units can form a spine to create space division, storage, cable management and worksurface support
- Leg Options:
Height adjustable round legs
Fixed height rectangular legs



Rectangular Leg



Power Trough



Round Leg

GENERAL INFORMATION**Flexible Building components**

- Single leg tables (freestanding or mobile)
- Training Rooms
- Boardrooms
- Libraries
- 1 person general and private office
- 2 person workstation
- 3 person workstation
- 6+ person workstation
- Storage spine-based workstation

Easy to customize and reconfigure to fit specific requirements. From the facility manager's perspective, all workstations can be standardized to form a linear worksurface and power/data services, and their respective function or purpose can be governed by the type, quantity and placement of adjacent components like dividers, storage cabinets, shelves and accessories. These adjacent components can be easily reconfigured with minimal down time - without having to invite electrical and IT crews.

Compatible with various environments

- Clean, simple, elegant design language, with finishes suggesting comfortable, even domestic flavor. Understated to designer combinations, like anodized aluminum and white, give a hint of subtle sophistication.

Choice of **two functionally and visually different leg** supports

- Casters or levelers
- Height adjustable round legs
- Fixed height rectangular legs
- Optional anodized aluminum finish (Rectangular legs only). Refer to individual models for upcharge.

Various **power/data delivery** levels to choose from

- Wire basket to organize cable access under worksurfaces and storage units
- Vertical cable manager integrated into rectangular leg
- Worksurface edge-mounted power/data units (easy to reconfigure, plug into wall/floor outlets), or power troughs
- Single-sided and double-sided below worksurface power/data trough (desktop/floor standing computers and office equipment)
- Worksurface access door (access to below worksurface power outlets and data terminals)
- Above worksurface power/data trough provides immediate access for laptops, tablets and phones
- Storage integrated power/data unit
- Horizontal cable management under storage units with optional wire basket

Interconnected storage units can form a spine to create space division, storage, cable management and worksurface support. Storage leg can be configured to act as a ganging bracket.

- GREENGUARD INDOOR AIR QUALITY CERTIFICATION - Global laminate and seating products are in compliance with stringent emission guidelines set out by the Greenguard Environmental Institute under the standards for low emitting products and materials. www.greenguard.org.

- **Level 3 Certified**

B BRIDGES II™ - NOTES

WORKSURFACES

- Standard in high performance thermally fused laminate. Optional high pressure (HP) laminate available.
- High performance thermally fused laminate tops are 1" thick particle board and have a flat 3mm edge profile on all sides
- High pressure (HP) laminate tops are 1-1/16" thick laminate particle board and have a flat 3mm edge profile on all sides
- Laminate surfaces offer a selection of matching + coordinating edgeband. Specify separately from the surface finish.

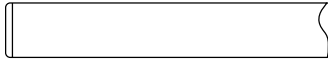

- Products specified with the high pressure laminate option are finished on the underside of the surface with a kraft paper backing.
- Doors and Drawer Fronts feature a matching 3mm edge. All other surfaces feature a matching self edge.

TABLES

- All multiple linear workstations are standard with levelers
- Tops square for flush surface-to-surface abutment and to accept desk mounted accessories
- Worksurfaces provided with pilot holes for alignment purposes

CODES

- This price list uses a numbering system with meaningful alphanumeric characters to create a simple-to-understand product number. This makes specifying the product much easier and more accurate.

Example of a worksurface:

Product code: BRTWS2472AWC + HP

BRT = Bridges II

WS = Type of Worksurface

2472 = Size: Depth x Width

AWC = High Pressure Laminate

HP = Finish

RECTANGULAR LEG

- For single and shared worksurface support
- Bridges II Rectangular legs are available with: Locking Casters (**BRTLCS**) or Levelers (**BRTLVS**)

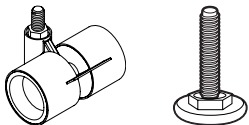

- Casters and Levelers **CANNOT** be retrofitted
- Levelers have a 2" height range, with 5/16" thread
- Levelers are available in Black only
- Casters are 45mm high with 8mm thread, available in White body / Grey tire combination only
- Leg frame is offered in 8 standard paint finishes and anodized aluminum finish
- Paint finish is a durable, environmentally friendly epoxy powder coating
- When anodized finish is selected, crossbeam is always White

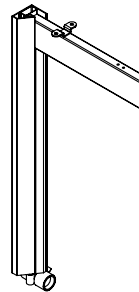

ROUND LEG

- For single and shared worksurface support
- Tubular steel legs are adjustable in 1" increments
- Height adjustment allows the user to easily set the height of a table
- Legs have a height adjustment of 24" - 32" in 1" increments with levelers and 27" - 35" with casters
- Bridges II Round legs are available with: Locking Casters (**BRTLCS**) or Levelers (**BRTLVR**)

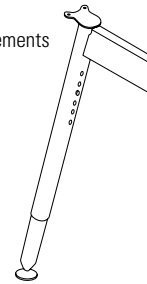
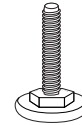

- Casters and Levelers CAN be retrofitted
- Levelers have a 1" height range, with 3/8-16" thread
- Levelers are available in Chrome only
- Casters available in Tungsten/Black combination only
- Casters are 3" diameter with an overall height of 3 3/4" with 3/8-16" thread
- Inner legs are available in Chrome only
- Leg frame is offered in 8 standard paint finishes
- Paint finish is a durable, environmentally friendly epoxy powder coating

FINISHES

Metal Frame Finishes:

BLK	Black
CHR	Charcoal
DWT	Designer White
NEV	Nevada
SIL	Silver
TPE	Taupe
TUN	Tungsten
TU2	Tungsten 2
ANO	Anodized Aluminum - Upcharge applies. Refer to models for upcharge.

Laminate Top Finishes:

ACJ	Absolute Acajou
ASN	Asian Night
AWC	Avant Cherry
AWH	Avant Honey
BLK	Black - Coordinates with BLK Metal Frame Finish
BRC	Brushed Cobalt - Coordinates with TUN Metal Frame Finish
CMB	Clear Maple
CGY	Custom Grey - Coordinates with SIL Metal Frame Finish
DES	Dark Espresso
DWT	Designer White - Coordinates with DWT Metal Frame Finish
HGT	Hayden Grey
QTM	Quartered Mahogany
SOG	Storm Grey - Coordinates with CHR Metal Frame Finish
STG	String - Coordinates with NEV Metal Frame Finish
TFW	Tiger Fruitwood
TWL	Tiger Walnut
WHE	Walnut Heights
WHC	White Chocolate
WCR	Winter Cherry
WGY	Willow Grey

Edgeband Finishes:

AAE	Absolute Acajou
ASE	Asian Night
ACE	Avant Cherry
AHE	Avant Honey
BLK	Black
BRC	Brushed Cobalt
CHR	Charcoal (<i>use w/SOG</i>)
CME	Clear Maple
DEE	Dark Espresso
DWE	Designer White
NEV	Nevada (<i>use w/STG</i>)
QTM	Quartered Mahogany
SIL	Silver (<i>use w/WGY</i>)
TPE	Taupe (<i>use w/HGT</i>)
TFE	Tiger Fruitwood
TWE	Tiger Walnut
WHE	Walnut Heights
CBE	White Chocolate
WCE	Winter Cherry

Chassis/Accent Finishes:

ACJ	Absolute Acajou
ASN	Asian Night
AWC	Avant Cherry
AWH	Avant Honey
BLK	Black - Coordinates with BLK Metal Frame Finish
BRC	Brushed Cobalt - Coordinates with TUN Metal Frame Finish
CGY	Custom Grey - Coordinates with SIL Metal Frame Finish
CMB	Clear Maple
DES	Dark Espresso
DWT	Designer White - Coordinates with DWT Metal Frame Finish
HGT	Hayden Grey - Coordinates with TPE Metal Frame Finish
QTM	Quartered Mahogany
SOG	Storm Grey - Coordinates with CHR Metal Frame Finish
STG	String - Coordinates with NEV Metal Frame Finish
TFW	Tiger Fruitwood
TWL	Tiger Walnut
WHC	White Chocolate
WHE	Walnut Heights
WCR	Winter Cherry

FABRIC TABLE DIVIDERS / SEAT PRIVACY PARTITIONS

Bridges II Fabric Table Dividers are available in:

- Global: **Anchorage, Lola, Brinx, Mariposa, Merge, and Accent**
- Momentum: **Meander, Tracery and Universe (extended lead time).**

COLLABORATIVE SEATING

- All standard seating fabrics and grades apply.

30"W UNITS STORAGE CAPACITY CHART

Side to Side

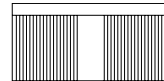

LETTER LETTER

Side to Side Letter/Front to Back Legal

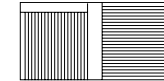

LETTER LEGAL

36"W UNITS STORAGE CAPACITY CHART

Side to Side Letter

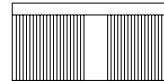

LETTER LETTER

Side to Side Legal

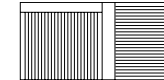

LETTER LEGAL

Side to Side Letter/Front to Back Legal



LEGAL LEGAL

RECTANGULAR LEG PACKAGES

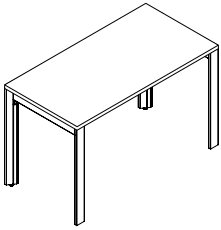

Single Line 1 Person Pod with Levelers

MODEL#	DIMENSIONS	FREIGHT CLASS	WT/LBS.	CUBIC FT.	LIST PRICE	HP ADD
D x W x H						
BRTS1P2484L	24 x 84 x 29	70	75	4.92	\$1169	\$113
BRTS1P2478L	24 x 78 x 29	85	72	4.82	\$1135	\$108
BRTS1P2472L	24 x 72 x 29	85	69	4.73	\$1095	\$112
BRTS1P2466L	24 x 66 x 29	85	66	4.65	\$1083	\$99
BRTS1P2463L	24 x 62.5 x 29	85	63	4.57	\$1075	\$96
BRTS1P2460L	24 x 60 x 29	85	60	4.48	\$1063	\$95
BRTS1P2454L	24 x 54 x 29	85	57	4.40	\$1026	\$83
BRTS1P2451L	24 x 50.5 x 29	85	54	4.30	\$999	\$79
BRTS1P2448L	24 x 48 x 29	85	51	4.20	\$972	\$75
BRTS1P2442L	24 x 42 x 29	92.5	48	4.10	\$929	\$61
BRTS1P2436L	24 x 36 x 29	92.5	45	4	\$872	\$53
BRTS1P3084L	30 x 84 x 29	70	84	5.20	\$1226	\$121
BRTS1P3078L	30 x 78 x 29	70	81	5.10	\$1178	\$112
BRTS1P3072L	30 x 72 x 29	70	78	5.01	\$1150	\$110
BRTS1P3066L	30 x 66 x 29	70	75	4.90	\$1123	\$105
BRTS1P3063L	30 x 62.5 x 29	70	72	4.80	\$1114	\$102
BRTS1P3060L	30 x 60 x 29	85	69	4.73	\$1104	\$99
BRTS1P3054L	30 x 54 x 29	85	66	4.60	\$1078	\$82
BRTS1P3051L	30 x 50.5 x 29	85	63	4.50	\$1058	\$86
BRTS1P3048L	30 x 48 x 29	85	60	4.41	\$1040	\$83
BRTS1P3042L	30 x 42 x 29	85	57	4.30	\$1018	\$81
BRTS1P3036L	30 x 36 x 29	85	54	4.20	\$940	\$56

Single Line Table Assemblies consist of one worksurface, two leg assemblies, and one supporting structural beam.

- Anodized Aluminum Leg - Add **\$113** list upcharge

Required Specifications

Top finish
Edge finish
Metal finish (legs)

Optional Specifications

Anodized Aluminum Leg
HP laminate

RECTANGULAR LEG PACKAGES

MODEL#	DIMENSIONS	FREIGHT CLASS	WT/LBS.	CUBIC FT.	LIST PRICE	HP ADD
	D x W x H					
BRTS1P2484C	24 x 84 x 29	70	75	4.92	\$1226	\$113
BRTS1P2478C	24 x 78 x 29	85	72	4.82	\$1192	\$108
BRTS1P2472C	24 x 72 x 29	85	69	4.73	\$1160	\$105
BRTS1P2466C	24 x 66 x 29	85	66	4.65	\$1141	\$99
BRTS1P2463C	24 x 62.5 x 29	85	63	4.57	\$1131	\$96
BRTS1P2460C	24 x 60 x 29	85	60	4.48	\$1121	\$95
BRTS1P2454C	24 x 54 x 29	85	57	4.40	\$1083	\$83
BRTS1P2451C	24 x 50.5 x 29	85	54	4.30	\$1056	\$79
BRTS1P2448C	24 x 48 x 29	85	51	4.20	\$1029	\$75
BRTS1P2442C	24 x 42 x 29	92.5	48	4.10	\$985	\$61
BRTS1P2436C	24 x 36 x 29	92.5	45	4	\$930	\$53
BRTS1P3084C	30 x 84 x 29	70	84	5.20	\$1293	\$112
BRTS1P3078C	30 x 78 x 29	70	81	5.10	\$1235	\$112
BRTS1P3072C	30 x 72 x 29	70	78	5.01	\$1207	\$94
BRTS1P3066C	30 x 66 x 29	70	75	4.90	\$1181	\$105
BRTS1P3063C	30 x 62.5 x 29	70	72	4.80	\$1172	\$102
BRTS1P3060C	30 x 60 x 29	85	69	4.73	\$1161	\$99
BRTS1P3054C	30 x 54 x 29	85	66	4.60	\$1136	\$82
BRTS1P3051C	30 x 50.5 x 29	85	63	4.50	\$1116	\$86
BRTS1P3048C	30 x 48 x 29	85	60	4.41	\$1097	\$83
BRTS1P3042C	30 x 42 x 29	85	57	4.30	\$1076	\$81
BRTS1P3036C	30 x 36 x 29	85	54	4.20	\$998	\$56

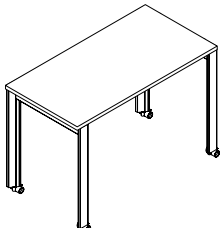

Single Line 1 Person Pod with Casters

Single Line Table Assemblies consist of one worksurface, two leg assemblies, and one supporting structural beam. 40mm white locking casters with grey tires; steel horizontal beams, aluminum legs.

- Anodized Aluminum Leg - Add **\$113**. list upcharge

Required Specifications

Top finish
Edge finish
Metal finish (legs)

Optional Specifications

Anodized Aluminum Leg
HP laminate

RECTANGULAR LEG PACKAGES

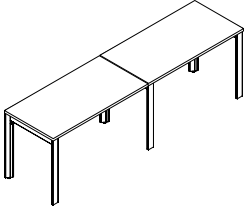

Single Line 2 Person Pod with Levelers

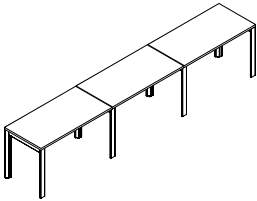

Single Line 3 Person Pod with Levelers

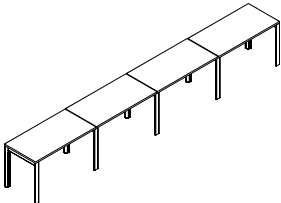

Single Line 4 Person Pod with Levelers

MODEL#	DIMENSIONS D x W x H	FREIGHT CLASS	WT/LBS.	CUBIC FT.	LIST PRICE	HP ADD
BRTS2P2484L	24 x 168 x 29	70	149	7.41	\$2049	\$225
BRTS2P2478L	24 x 156 x 29	70	140	7.27	\$1981	\$214
BRTS2P2472L	24 x 144 x 29	70	131	7.13	\$1918	\$208
BRTS2P2466L	24 x 132 x 29	70	122	6.95	\$1877	\$196
BRTS2P2460L	24 x 120 x 29	70	113	6.71	\$1837	\$190
BRTS2P2454L	24 x 108 x 29	70	104	6.45	\$1763	\$165
BRTS2P2448L	24 x 96 x 29	70	95	6.21	\$1654	\$148
BRTS2P3084L	30 x 168 x 29	70	173	8.25	\$2150	\$242
BRTS2P3078L	30 x 156 x 29	70	164	7.97	\$2055	\$222
BRTS2P3072L	30 x 144 x 29	70	155	7.69	\$2012	\$216
BRTS2P3066L	30 x 132 x 29	70	140	7.41	\$1944	\$208
BRTS2P3060L	30 x 120 x 29	70	131	7.13	\$1906	\$196
BRTS2P3054L	30 x 108 x 29	70	122	6.85	\$1852	\$165
BRTS2P3048L	30 x 96 x 29	70	113	6.57	\$1777	\$165

Single Line 2 Person workstation consists of two worksurfaces, three leg assemblies, and two supporting structural beams. One leg can be shared by 2 adjoining worksurfaces.

- Anodized Aluminum Leg - Add **\$167.** list upcharge

BRTS3P2484L	24 x 252 x 29	70	219	9.74	\$2931	\$336
BRTS3P2478L	24 x 234 x 29	70	206	9.53	\$2828	\$319
BRTS3P2472L	24 x 216 x 29	70	192	9.32	\$2733	\$311
BRTS3P2466L	24 x 198 x 29	70	179	9.11	\$2672	\$294
BRTS3P2460L	24 x 180 x 29	70	165	8.89	\$2614	\$271
BRTS3P2454L	24 x 162 x 29	70	152	8.68	\$2501	\$246
BRTS3P2448L	24 x 144 x 29	70	138	8.47	\$2338	\$220
BRTS3P3084L	30 x 252 x 29	65	263	11.59	\$3074	\$362
BRTS3P3078L	30 x 234 x 29	70	246	11.16	\$2932	\$333
BRTS3P3072L	30 x 216 x 29	70	229	10.72	\$2846	\$325
BRTS3P3066L	30 x 198 x 29	70	212	10.30	\$2764	\$311
BRTS3P3060L	30 x 180 x 29	70	195	9.87	\$2708	\$294
BRTS3P3054L	30 x 162 x 29	70	178	9.44	\$2627	\$246
BRTS3P3048L	30 x 144 x 29	70	161	9.01	\$2515	\$246

Single Line 3 Person workstation consists of three worksurfaces, four leg assemblies, and three supporting structural beams. One leg can be shared by 2 adjoining worksurfaces.

- Anodized Aluminum Leg - Add **\$217.** list upcharge

BRTS4P2484L	24 x 336 x 29	70	291	13.67	\$3810	\$449
BRTS4P2478L	24 x 312 x 29	70	273	13.18	\$3673	\$426
BRTS4P2472L	24 x 288 x 29	70	254	12.69	\$3569	\$420
BRTS4P2466L	24 x 264 x 29	70	236	12.20	\$3467	\$391
BRTS4P2460L	24 x 240 x 29	70	217	11.71	\$3387	\$380
BRTS4P2454L	24 x 216 x 29	70	199	11.22	\$3238	\$328
BRTS4P2448L	24 x 192 x 29	70	180	10.73	\$3020	\$294
BRTS4P3084L	30 x 336 x 29	65	345	14.87	\$3997	\$483
BRTS4P3078L	30 x 312 x 29	65	323	14.30	\$3808	\$442
BRTS4P3072L	30 x 288 x 29	70	301	13.73	\$3694	\$431
BRTS4P3066L	30 x 264 x 29	70	279	13.16	\$3585	\$414
BRTS4P3060L	30 x 240 x 29	70	257	12.59	\$3511	\$391
BRTS4P3054L	30 x 216 x 29	70	235	12.02	\$3402	\$328
BRTS4P3048L	30 x 192 x 29	70	213	11.45	\$3253	\$328

Single Line 4 Person workstation consists of four worksurfaces, five leg assemblies, and four supporting structural beams. One leg can be shared by 2 adjoining worksurfaces.

- Anodized Aluminum Leg - Add **\$281.** list upcharge

Required Specifications

Top finish
Edge finish
Metal finish (legs)

Optional Specifications

Anodized Aluminum Leg
HP laminate

RECTANGULAR LEG PACKAGES

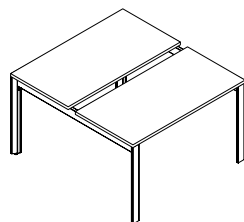

Back-to-Back 2 Person Pod with Levelers

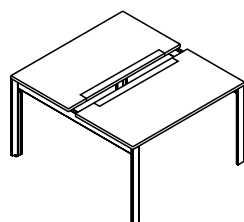

Back-to-Back 2 Person Pod with Access Door and Levelers

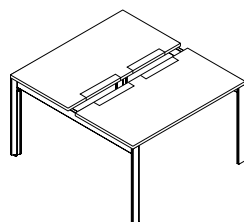

Back-to-Back 2 Person Pod with Access Doors and Levelers

MODEL#	DIMENSIONS	FREIGHT CLASS	WT/LBS.	CUBIC FT.	LIST PRICE	HP ADD
--------	------------	---------------	---------	-----------	------------	--------

D x W x H

BRTBAR2P2484L	50.5 x 84 x 29	70	146	9.40	\$1935	\$225
BRTBAR2P2478L	50.5 x 78 x 29	85	137	9.20	\$1866	\$214
BRTBAR2P2472L	50.5 x 72 x 29	85	128	9.02	\$1803	\$208
BRTBAR2P2466L	50.5 x 66 x 29	85	119	8.76	\$1763	\$196
BRTBAR2P2460L	50.5 x 60 x 29	85	110	8.56	\$1724	\$190

BRTBAR2P3084L	62.5 x 84 x 29	70	174	10.40	\$1993	\$242
BRTBAR2P3078L	62.5 x 78 x 29	70	163	9.80	\$1905	\$214
BRTBAR2P3072L	62.5 x 72 x 29	70	152	9.54	\$1843	\$214
BRTBAR2P3066L	62.5 x 66 x 29	70	141	9.25	\$1787	\$208
BRTBAR2P3060L	62.5 x 60 x 29	85	130	9	\$1748	\$196

Back-to-back 2 Person workstation consists of two worksurfaces, two back-to-back leg assemblies, and two supporting structural beams.

- Anodized Aluminum Leg - Add **\$113**. list upcharge

BRTBAR2PA2484L	50.5 x 84 x 29	70	146	9.40	\$2035	\$402
BRTBAR2PA2478L	50.5 x 78 x 29	85	137	9.20	\$1978	\$360
BRTBAR2PA2472L	50.5 x 72 x 29	85	128	9.02	\$1935	\$345
BRTBAR2PA2466L	50.5 x 66 x 29	85	119	8.76	\$1864	\$302
BRTBAR2PA2460L	50.5 x 60 x 29	85	110	8.56	\$1792	\$273

BRTBAR2PA3084L	62.5 x 84 x 29	70	174	10.40	\$2221	\$489
BRTBAR2PA3078L	62.5 x 78 x 29	70	163	9.80	\$2150	\$460
BRTBAR2PA3072L	62.5 x 72 x 29	70	152	9.54	\$2107	\$418
BRTBAR2PA3066L	62.5 x 66 x 29	70	141	9.25	\$2035	\$373
BRTBAR2PA3060L	62.5 x 60 x 29	85	130	9	\$1935	\$345

Back-to-back 2 Person workstation consists of two worksurfaces, two back-to-back leg assemblies, and two supporting structural beams. Anodized aluminum worksurface door provides access to power/data trough below worksurface. Worksurface with access doors CANNOT be combined with above worksurface power trough.

- Anodized Aluminum Leg - Add **\$113**. list upcharge

BRTBAR2PDA2484L	50.5 x 84 x 29	70	146	9.40	\$2196	\$431
BRTBAR2PDA2478L	50.5 x 78 x 29	85	137	9.20	\$2134	\$387
BRTBAR2PDA2472L	50.5 x 72 x 29	85	128	9.02	\$2088	\$371
BRTBAR2PDA2466L	50.5 x 66 x 29	85	119	8.76	\$2011	\$325
BRTBAR2PDA2460L	50.5 x 60 x 29	85	110	8.56	\$1934	\$293

BRTBAR2PDA3084L	62.5 x 84 x 29	70	174	10.40	\$2397	\$525
BRTBAR2PDA3078L	62.5 x 78 x 29	70	163	9.80	\$2319	\$493
BRTBAR2PDA3072L	62.5 x 72 x 29	70	152	9.54	\$2274	\$446
BRTBAR2PDA3066L	62.5 x 66 x 29	70	141	9.25	\$2196	\$399
BRTBAR2PDA3060L	62.5 x 60 x 29	85	130	9	\$2088	\$371

Back-to-back 2 Person workstation consists of two worksurfaces, two back-to-back leg assemblies, and two supporting structural beams. These tables feature dual access doors providing a central connection point for monitor lifts. Anodized aluminum worksurface door provides access to power/data trough below worksurface. Worksurface with access doors CANNOT be combined with above worksurface power trough.

- Anodized Aluminum Leg - Add **\$113**. list upcharge

Required Specifications

Top finish
Edge finish
Metal finish (legs)

Optional Specifications

Anodized Aluminum Leg
HP laminate

RECTANGULAR LEG PACKAGES

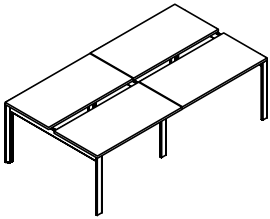

Back-to-Back 4 Person Pod with Levelers

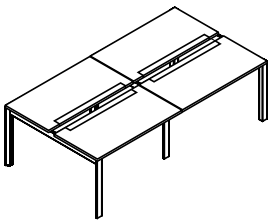

Back-to-Back 4 Person Pod with Access Door and Levelers

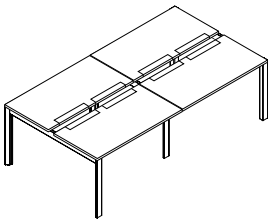

Back-to-Back 4 Person Pod with Access Door and Levelers

MODEL#	DIMENSIONS D x W x H	FREIGHT CLASS	WT/LBS.	CUBIC FT.	LIST PRICE	HP ADD
BRTBAR4P2484L	50.5 x 168 x 29	70	272	15.66	\$3467	\$449
BRTBAR4P2478L	50.5 x 156 x 29	70	256	15.20	\$3329	\$426
BRTBAR4P2472L	50.5 x 144 x 29	70	240	14.74	\$3204	\$414
BRTBAR4P2466L	50.5 x 132 x 29	70	224	14.28	\$3124	\$391
BRTBAR4P2460L	50.5 x 120 x 29	70	208	13.82	\$3043	\$380
BRTBAR4P3084L	62.5 x 168 x 29	70	333	16.86	\$3611	\$483
BRTBAR4P3078L	62.5 x 156 x 29	70	313	16.32	\$3421	\$442
BRTBAR4P3072L	62.5 x 144 x 29	70	293	15.78	\$3307	\$431
BRTBAR4P3066L	62.5 x 132 x 29	70	273	15.24	\$3199	\$414
BRTBAR4P3060L	62.5 x 120 x 29	70	253	14.70	\$3124	\$391

Back-to-back 4 Person workstation consists of four worksurfaces, two back-to-back outer leg assemblies, 1 back-to-back narrow leg assembly, and four supporting structural beams.

- Anodized Aluminum Leg - Add **\$167.** list upcharge

BRTBAR4PA2484L	50.5 x 168 x 29	70	272	15.66	\$3668	\$804
BRTBAR4PA2478L	50.5 x 156 x 29	70	256	15.20	\$3553	\$717
BRTBAR4PA2472L	50.5 x 144 x 29	70	240	14.74	\$3467	\$689
BRTBAR4PA2466L	50.5 x 132 x 29	70	224	14.28	\$3324	\$603
BRTBAR4PA2460L	50.5 x 120 x 29	70	208	13.82	\$3180	\$546
BRTBAR4PA3084L	62.5 x 168 x 29	70	333	16.86	\$4011	\$975
BRTBAR4PA3078L	62.5 x 156 x 29	70	313	16.32	\$3868	\$918
BRTBAR4PA3072L	62.5 x 144 x 29	70	293	15.78	\$3783	\$833
BRTBAR4PA3066L	62.5 x 132 x 29	70	273	15.24	\$3639	\$746
BRTBAR4PA3060L	62.5 x 120 x 29	70	253	14.70	\$3439	\$689

Back-to-back 4 Person workstation consists of four worksurfaces, two back-to-back outer leg assemblies, 1 back-to-back narrow leg assembly, and four supporting structural beams. Anodized aluminum worksurface door provides access to power/data trough below worksurface. Worksurface with access doors CANNOT be combined with above worksurface power trough.

- Anodized Aluminum Leg - Add **\$167.** list upcharge

BRTBAR4PDA2484L	50.5 x 168 x 29	70	272	15.66	\$3958	\$863
BRTBAR4PDA2478L	50.5 x 156 x 29	70	256	15.20	\$3834	\$770
BRTBAR4PDA2472L	50.5 x 144 x 29	70	240	14.74	\$3740	\$741
BRTBAR4PDA2466L	50.5 x 132 x 29	70	224	14.28	\$3588	\$645
BRTBAR4PDA2460L	50.5 x 120 x 29	70	208	13.82	\$3431	\$585
BRTBAR4PDA3084L	62.5 x 168 x 29	70	333	16.86	\$4329	\$1047
BRTBAR4PDA3078L	62.5 x 156 x 29	70	313	16.32	\$4173	\$986
BRTBAR4PDA3072L	62.5 x 144 x 29	70	293	15.78	\$4081	\$892
BRTBAR4PDA3066L	62.5 x 132 x 29	70	273	15.24	\$3926	\$802
BRTBAR4PDA3060L	62.5 x 120 x 29	70	253	14.70	\$3711	\$739

Back-to-back 4 Person workstation consists of four worksurfaces, two back-to-back outer leg assemblies, 1 back-to-back narrow leg assembly, and four supporting structural beams. These tables feature dual access doors providing a central connection point for monitor lifts. Anodized aluminum worksurface door provides access to power/data trough below worksurface. Worksurface with access doors CANNOT be combined with above worksurface power trough.

- Anodized Aluminum Leg - Add **\$167.** list upcharge

Required Specifications

Top finish
Edge finish
Metal finish (legs)

Optional Specifications

Anodized Aluminum Leg
HP laminate

RECTANGULAR LEG PACKAGES

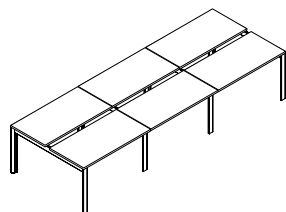

Back-to-Back 6 Person Pod with Levelers

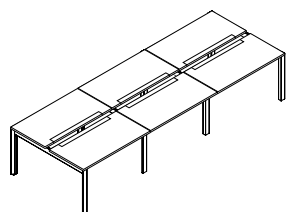

Back-to-Back 6 Person Pod with Access Door and Levelers

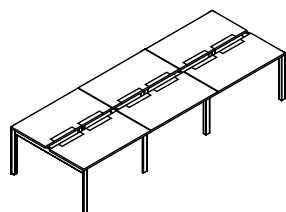

Back-to-Back 6 Person Pod with Access Door and Levelers

MODEL#	DIMENSIONS D x W x H	FREIGHT CLASS	WT/LBS.	CUBIC FT.	LIST PRICE	HP ADD
BRTBAR6P2484L	50.5 x 252 x 29	70	434	22.88	\$5000	\$672
BRTBAR6P2478L	50.5 x 234 x 29	70	409	22.10	\$4793	\$637
BRTBAR6P2472L	50.5 x 216 x 29	70	359	21.32	\$4605	\$621
BRTBAR6P2466L	50.5 x 198 x 29	70	329	20.54	\$4484	\$586
BRTBAR6P2460L	50.5 x 180 x 29	70	308	19.76	\$4336	\$568
BRTBAR6P3084L	62.5 x 252 x 29	70	493	24.53	\$5201	\$724
BRTBAR6P3078L	62.5 x 234 x 29	70	462	23.75	\$4917	\$663
BRTBAR6P3072L	62.5 x 216 x 29	70	431	22.86	\$4746	\$646
BRTBAR6P3066L	62.5 x 198 x 29	70	400	21.97	\$4581	\$621
BRTBAR6P3060L	62.5 x 180 x 29	70	369	21.08	\$4441	\$586

Back-to-back 6 Person workstation consists of six worksurfaces, two back-to-back outer leg assemblies, two back-to-back narrow leg assemblies, and six supporting structural beams.

- Anodized Aluminum Leg - Add **\$224**. list upcharge

BRTBAR6PA2484L	50.5 x 252 x 29	70	434	22.88	\$5301	\$1205
BRTBAR6PA2478L	50.5 x 234 x 29	70	409	22.10	\$5129	\$1076
BRTBAR6PA2472L	50.5 x 216 x 29	70	359	21.32	\$5000	\$1033
BRTBAR6PA2466L	50.5 x 198 x 29	70	329	20.54	\$4785	\$904
BRTBAR6PA2460L	50.5 x 180 x 29	70	308	19.76	\$4542	\$817
BRTBAR6PA3084L	62.5 x 252 x 29	70	493	24.53	\$5802	\$1462
BRTBAR6PA3078L	62.5 x 234 x 29	70	462	23.75	\$5587	\$1377
BRTBAR6PA3072L	62.5 x 216 x 29	70	431	22.86	\$5458	\$1248
BRTBAR6PA3066L	62.5 x 198 x 29	70	400	21.97	\$5243	\$1119
BRTBAR6PA3060L	62.5 x 180 x 29	70	369	21.08	\$4914	\$1033

Back-to-back 6 Person workstation consists of six worksurfaces, two back-to-back outer leg assemblies, two back-to-back narrow leg assemblies, and six supporting structural beams. Anodized aluminum worksurface door provides access to power/data trough below worksurface. Worksurface with access doors CANNOT be combined with above worksurface power trough.

- Anodized Aluminum Leg - Add **\$224**. list upcharge

BRTBAR6PDA2484L	50.5 x 252 x 29	70	434	22.88	\$5720	\$1291
BRTBAR6PDA2478L	50.5 x 234 x 29	70	409	22.10	\$5535	\$1156
BRTBAR6PDA2472L	50.5 x 216 x 29	70	359	21.32	\$5396	\$1110
BRTBAR6PDA2466L	50.5 x 198 x 29	70	329	20.54	\$5163	\$927
BRTBAR6PDA2460L	50.5 x 180 x 29	70	308	19.76	\$4900	\$878
BRTBAR6PDA3084L	62.5 x 252 x 29	70	493	24.53	\$6261	\$1571
BRTBAR6PDA3078L	62.5 x 234 x 29	70	462	23.75	\$6028	\$1478
BRTBAR6PDA3072L	62.5 x 216 x 29	70	431	22.86	\$5889	\$1338
BRTBAR6PDA3066L	62.5 x 198 x 29	70	400	21.97	\$5657	\$1200
BRTBAR6PDA3060L	62.5 x 180 x 29	70	369	21.08	\$5303	\$1109

Back-to-back 6 Person workstation consists of six worksurfaces, two back-to-back outer leg assemblies, two back-to-back narrow leg assemblies, and six supporting structural beams. These tables feature dual access doors providing a central connection point for monitor lifts. Anodized aluminum worksurface door provides access to power/data trough below worksurface. Worksurface with access doors CANNOT be combined with above worksurface power trough.

- Anodized Aluminum Leg - Add **\$224**. list upcharge

Required Specifications

Top finish
Edge finish
Metal finish (legs)

Optional Specifications

Anodized Aluminum Leg
HP laminate

RECTANGULAR LEG PACKAGES

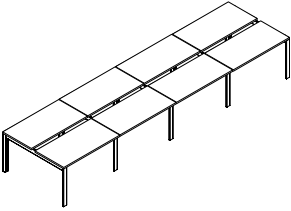

Back-to-Back 8 Person Pod with Levelers

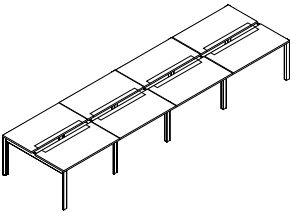

Back-to-Back 8 Person Pod with Access Door and Levelers

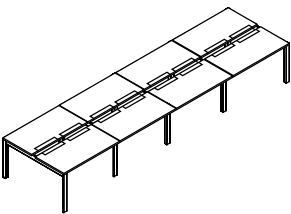

Back-to-Back 8 Person Pod with Access Door and Levelers

MODEL#	DIMENSIONS D x W x H	FREIGHT CLASS	WT./LBS.	CUBIC FT.	LIST PRICE	HP ADD
BRTBAR8P2484L	50.5 x 336 x 29	70	556	28.30	\$6533	\$896
BRTBAR8P2478L	50.5 x 312 x 29	70	520	27.30	\$6258	\$849
BRTBAR8P2472L	50.5 x 288 x 29	70	484	26.30	\$6005	\$826
BRTBAR8P2466L	50.5 x 264 x 29	70	448	25.30	\$5845	\$780
BRTBAR8P2460L	50.5 x 240 x 29	70	412	24.42	\$5713	\$758
BRTBAR8P3084L	62.5 x 336 x 29	70	669	30.58	\$6790	\$965
BRTBAR8P3078L	62.5 x 312 x 29	70	625	29.48	\$6412	\$883
BRTBAR8P3072L	62.5 x 288 x 29	70	581	28.38	\$6184	\$861
BRTBAR8P3066L	62.5 x 264 x 29	70	536	27.28	\$5965	\$826
BRTBAR8P3060L	62.5 x 240 x 29	70	492	26.18	\$5816	\$780

Back-to-back 8 Person workstation consists of eight worksurfaces, two back-to-back outer leg assemblies, three back-to-back narrow leg assemblies, and eight supporting structural beams.

- Anodized Aluminum Leg - Add **\$281**. list upcharge

BRTBAR8PA2484L	50.5 x 336 x 29	70	556	28.30	\$6933	\$1605
BRTBAR8PA2478L	50.5 x 312 x 29	70	520	27.30	\$6704	\$1433
BRTBAR8PA2472L	50.5 x 288 x 29	70	484	26.30	\$6533	\$1377
BRTBAR8PA2466L	50.5 x 264 x 29	70	448	25.30	\$6246	\$1205
BRTBAR8PA2460L	50.5 x 240 x 29	70	412	24.42	\$5989	\$1090
BRTBAR8PA3084L	62.5 x 336 x 29	70	669	30.58	\$7593	\$1949
BRTBAR8PA3078L	62.5 x 312 x 29	70	625	29.48	\$7305	\$1835
BRTBAR8PA3072L	62.5 x 288 x 29	70	581	28.38	\$7134	\$1663
BRTBAR8PA3066L	62.5 x 264 x 29	70	536	27.28	\$6848	\$1491
BRTBAR8PA3060L	62.5 x 240 x 29	70	492	26.18	\$6446	\$1377

Back-to-back 8 Person workstation consists of eight worksurfaces, two back-to-back outer leg assemblies, three back-to-back narrow leg assemblies, and eight supporting structural beams. Anodized aluminum worksurface door provides access to power/data trough below worksurface. Worksurface with access doors CANNOT be combined with above worksurface power trough.

- Anodized Aluminum Leg - Add **\$281**. list upcharge

BRTBAR8PDA2484L	50.5 x 336 x 29	70	556	28.30	\$7481	\$1725
BRTBAR8PDA2478L	50.5 x 312 x 29	70	520	27.30	\$7232	\$1540
BRTBAR8PDA2472L	50.5 x 288 x 29	70	484	26.30	\$7048	\$1479
BRTBAR8PDA2466L	50.5 x 264 x 29	70	448	25.30	\$6739	\$1294
BRTBAR8PDA2460L	50.5 x 240 x 29	70	412	24.42	\$6461	\$1171
BRTBAR8PDA3084L	62.5 x 336 x 29	70	669	30.58	\$8192	\$1946
BRTBAR8PDA3078L	62.5 x 312 x 29	70	625	29.48	\$7881	\$1972
BRTBAR8PDA3072L	62.5 x 288 x 29	70	581	28.38	\$7696	\$1788
BRTBAR8PDA3066L	62.5 x 264 x 29	70	536	27.28	\$7389	\$1600
BRTBAR8PDA3060L	62.5 x 240 x 29	70	492	26.18	\$6955	\$1479

Back-to-back 8 Person workstation consists of eight worksurfaces, two back-to-back outer leg assemblies, three back-to-back narrow leg assemblies, and eight supporting structural beams. These tables feature dual access doors providing a central connection point for monitor lifts. Anodized aluminum worksurface door provides access to power/data trough below worksurface. Worksurface with access doors CANNOT be combined with above worksurface power trough.

- Anodized Aluminum Leg - Add **\$281**. list upcharge

Required Specifications

Top finish
Edge finish
Metal finish (legs)

Optional Specifications

Anodized Aluminum Leg
HP laminate

RECTANGULAR LEG PACKAGES

MODEL# DIMENSIONS FREIGHT CLASS WT./LBS. CUBIC FT. LIST PRICE HP ADD

D x W x H

BRT36P2484C	24 x 84 x 36	70	120.68	6.42	\$2455	\$134
BRT36P2478C	24 x 78 x 36	70	114.16	6.13	\$2396	\$125
BRT36P2472C	24 x 72 x 36	70	107.64	5.83	\$2333	\$120
BRT36P2466C	24 x 66 x 36	70	101.12	5.62	\$2288	\$116
BRT36P2460C	24 x 60 x 36	70	94.60	5.41	\$2238	\$111
BRT36P2454C	24 x 54 x 36	70	88.08	5.19	\$2168	\$96
BRT36P2448C	24 x 48 x 36	70	81.56	4.98	\$2058	\$87
BRT36P2442C	24 x 42 x 36	70	76.04	4.76	\$1986	\$73
BRT36P2436C	24 x 36 x 36	70	68.52	4.55	\$1925	\$58

BRT36P3084C	30 x 84 x 36	70	148.11	7.32	\$2807	\$144
BRT36P3078C	30 x 78 x 36	70	139.96	6.95	\$2728	\$129
BRT36P3072C	30 x 72 x 36	70	131.81	6.59	\$2660	\$125
BRT36P3066C	30 x 66 x 36	70	123.66	6.32	\$2596	\$125
BRT36P3060C	30 x 60 x 36	70	115.51	6.06	\$2542	\$116
BRT36P3054C	30 x 54 x 36	70	107.36	5.79	\$2474	\$96
BRT36P3048C	30 x 48 x 36	70	99.21	5.53	\$2368	\$96
BRT36P3042C	30 x 42 x 36	70	91.06	5.26	\$2314	\$91
BRT36P3036C	30 x 36 x 36	70	83.91	5	\$2217	\$67

BRT36P3684C	36 x 84 x 36	70	161.97	8.91	\$3145	\$163
BRT36P3678C	36 x 78 x 36	70	152.82	8.50	\$3064	\$154
BRT36P3672C	36 x 72 x 36	70	144.67	8.10	\$2976	\$144
BRT36P3666C	36 x 66 x 36	70	135.52	7.79	\$2894	\$134
BRT36P3660C	36 x 60 x 36	70	126.37	7.48	\$2805	\$120
BRT36P3654C	36 x 54 x 36	70	118.22	7.18	\$2715	\$111
BRT36P3648C	36 x 48 x 36	70	109.07	6.87	\$2594	\$96
BRT36P3642C	36 x 42 x 36	70	99.92	6.56	\$2511	\$87

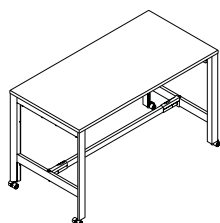

36"H Single Table with Casters

Single table assembly consists of one worksurface, two H leg assemblies, horizontal structural beams, and one bottom table beam. 40mm dia. locking casters with 8mm thread, white body and grey tires.

- 24"D tables include 3 horizontal structural beams. 30"/36"D tables include 4 horizontal structural beams.
- Anodized Aluminum Leg - Add **\$113**. list upcharge

BRT36P2484L	24 x 84 x 36	70	120.20	6.42	\$2375	\$134
BRT36P2478L	24 x 78 x 36	70	113.68	6.13	\$2316	\$125
BRT36P2472L	24 x 72 x 36	70	107.16	5.83	\$2253	\$120
BRT36P2466L	24 x 66 x 36	70	100.64	5.62	\$2209	\$116
BRT36P2460L	24 x 60 x 36	70	94.12	5.41	\$2157	\$111
BRT36P2454L	24 x 54 x 36	70	87.60	5.19	\$2087	\$96
BRT36P2448L	24 x 48 x 36	70	81.08	4.98	\$1978	\$87
BRT36P2442L	24 x 42 x 36	70	75.56	4.76	\$1906	\$73
BRT36P2436L	24 x 36 x 36	85	68.04	4.55	\$1844	\$58

BRT36P3084L	30 x 84 x 36	70	147.63	7.32	\$2727	\$144
BRT36P3078L	30 x 78 x 36	70	139.48	6.96	\$2649	\$129
BRT36P3072L	30 x 72 x 36	70	131.33	6.59	\$2580	\$125
BRT36P3066L	30 x 66 x 36	70	123.18	6.32	\$2516	\$125
BRT36P3060L	30 x 60 x 36	70	115.03	6.06	\$2461	\$116
BRT36P3054L	30 x 54 x 36	70	106.88	5.79	\$2393	\$96
BRT36P3048L	30 x 48 x 36	70	98.73	5.53	\$2288	\$96
BRT36P3042L	30 x 42 x 36	70	90.58	5.26	\$2234	\$91
BRT36P3036L	30 x 36 x 36	70	83.43	5	\$2137	\$67

BRT36P3684L	36 x 84 x 36	70	161.49	8.91	\$3065	\$163
BRT36P3678L	36 x 78 x 36	70	152.34	8.50	\$2983	\$154
BRT36P3672L	36 x 72 x 36	70	144.19	8.10	\$2897	\$144
BRT36P3666L	36 x 66 x 36	70	135.04	7.79	\$2813	\$134
BRT36P3660L	36 x 60 x 36	70	125.89	7.48	\$2726	\$120
BRT36P3654L	36 x 54 x 36	70	117.74	7.18	\$2634	\$111
BRT36P3648L	36 x 48 x 36	70	108.59	6.87	\$2515	\$96
BRT36P3642L	36 x 42 x 36	70	99.44	6.56	\$2430	\$87

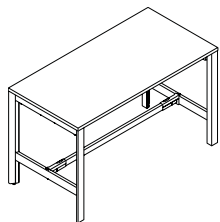

36"H Single Table with Levelers

Single table assembly consists of one worksurface, two H leg assemblies, horizontal structural beams, and one bottom table beam.

- 24"D tables include 3 horizontal structural beams. 30"/36"D tables include 4 horizontal structural beams.
- Anodized Aluminum Leg - Add **\$113**. list upcharge

Required Specifications

Top finish
Edge finish
Metal finish (legs)

Optional Specifications

Anodized Aluminum Leg
HP laminate

RECTANGULAR LEG PACKAGES

MODEL# DIMENSIONS FREIGHT CLASS WT/LBS. CUBIC FT. LIST PRICE HP ADD

D x W x H

BRT36A2484L	24 x 84 x 36	70	106.36	4.74	\$1920	\$134
BRT36A2478L	24 x 78 x 36	70	99.84	4.45	\$1863	\$125
BRT36A2472L	24 x 72 x 36	70	93.32	4.15	\$1800	\$120
BRT36A2466L	24 x 66 x 36	70	86.80	3.94	\$1755	\$116
BRT36A2460L	24 x 60 x 36	70	80.28	3.73	\$1704	\$111
BRT36A2454L	24 x 54 x 36	70	73.76	3.51	\$1633	\$96
BRT36A2448L	24 x 48 x 36	70	67.24	3.30	\$1525	\$87
BRT36A2442L	24 x 42 x 36	70	61.72	3.08	\$1453	\$73
BRT36A2436L	24 x 36 x 36	70	54.20	2.87	\$1391	\$58
BRT36A3084L	30 x 84 x 36	65	131.77	5.56	\$2245	\$144
BRT36A3078L	30 x 78 x 36	65	123.62	5.19	\$2166	\$129
BRT36A3072L	30 x 72 x 36	65	115.47	4.83	\$2097	\$125
BRT36A3066L	30 x 66 x 36	65	107.32	4.56	\$2034	\$125
BRT36A3060L	30 x 60 x 36	65	99.17	4.30	\$1978	\$116
BRT36A3054L	30 x 54 x 36	65	91.02	4.03	\$1910	\$96
BRT36A3048L	30 x 48 x 36	70	82.87	3.77	\$1805	\$96
BRT36A3042L	30 x 42 x 36	70	74.72	3.50	\$1750	\$91
BRT36A3036L	30 x 36 x 36	70	67.57	3.24	\$1654	\$67
BRT36A3684L	36 x 84 x 36	70	143.70	6.65	\$2514	\$163
BRT36A3678L	36 x 78 x 36	70	134.55	6.24	\$2432	\$154
BRT36A3672L	36 x 72 x 36	70	126.40	5.84	\$2345	\$144
BRT36A3666L	36 x 66 x 36	70	117.25	5.53	\$2262	\$134
BRT36A3660L	36 x 60 x 36	70	108.10	5.22	\$2174	\$120
BRT36A3654L	36 x 54 x 36	70	99.95	4.92	\$2083	\$111
BRT36A3648L	36 x 48 x 36	70	90.80	4.61	\$1963	\$96
BRT36A3642L	36 x 42 x 36	70	81.65	4.30	\$1879	\$87

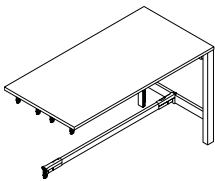

36" H Add-On with Levelers

Single table assembly consists of one worksurface, one H leg assembly, horizontal structural beams, and one bottom table beam.

- 24"D tables include 3 horizontal structural beams. 30"/36" D tables include 4 horizontal structural beams.
- Anodized Aluminum Leg - Add **\$56**. list upcharge

BRT42P2484C	24 x 84 x 42	70	122.58	6.98	\$2499	\$134
BRT42P2478C	24 x 78 x 42	70	116.06	6.69	\$2441	\$125
BRT42P2472C	24 x 72 x 42	70	109.54	6.39	\$2379	\$120
BRT42P2466C	24 x 66 x 42	70	103.02	6.18	\$2333	\$116
BRT42P2460C	24 x 60 x 42	70	96.50	5.97	\$2283	\$111
BRT42P2454C	24 x 54 x 42	70	89.98	5.75	\$2212	\$96
BRT42P2448C	24 x 48 x 42	70	83.46	5.54	\$2104	\$87
BRT42P2442C	24 x 42 x 42	85	77.94	5.32	\$2032	\$73
BRT42P2436C	24 x 36 x 42	85	70.42	5.11	\$1970	\$58
BRT42P3084C	30 x 84 x 42	70	150.01	7.92	\$2853	\$144
BRT42P3078C	30 x 78 x 42	70	141.86	7.55	\$2773	\$129
BRT42P3072C	30 x 72 x 42	70	133.71	7.19	\$2705	\$125
BRT42P3066C	30 x 66 x 42	70	125.56	6.92	\$2641	\$125
BRT42P3060C	30 x 60 x 42	70	117.41	6.66	\$2587	\$116
BRT42P3054C	30 x 54 x 42	70	109.26	6.39	\$2518	\$96
BRT42P3048C	30 x 48 x 42	70	101.11	6.13	\$2414	\$96
BRT42P3042C	30 x 42 x 42	70	92.96	5.86	\$2359	\$91
BRT42P3036C	30 x 36 x 42	70	85.81	5.60	\$2262	\$67
BRT42P3684C	36 x 84 x 42	70	163.87	9.69	\$3189	\$163
BRT42P3678C	36 x 78 x 42	70	154.72	9.28	\$3109	\$154
BRT42P3672C	36 x 72 x 42	70	146.57	8.88	\$3021	\$144
BRT42P3666C	36 x 66 x 42	70	137.42	8.57	\$2938	\$134
BRT42P3660C	36 x 60 x 42	70	128.27	8.26	\$2851	\$120
BRT42P3654C	36 x 54 x 42	70	120.12	7.96	\$2760	\$111
BRT42P3648C	36 x 48 x 42	85	110.97	7.65	\$2639	\$96
BRT42P3642C	36 x 42 x 42	85	101.82	7.34	\$2555	\$87

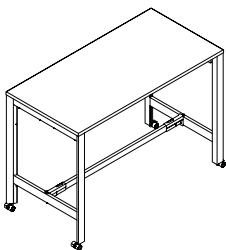

42" H Pod with Casters

Single table assembly consists of one worksurface, two H leg assemblies, horizontal structural beams and one bottom table beam. 40mm dia. locking casters with 8mm thread, white body and grey tires.

- 24"D tables include 3 horizontal structural beams. 30"/36" D tables include 4 horizontal structural beams.
- Anodized Aluminum Leg - Add **\$113**. list upcharge

Required Specifications

Top finish
Edge finish
Metal finish (legs)

Optional Specifications

Anodized Aluminum Leg
HP laminate

RECTANGULAR LEG PACKAGES

MODEL# DIMENSIONS FREIGHT CLASS WT./LBS. CUBIC FT. LIST PRICE HP ADD

D x W x H

BRT42P2484L	24 x 84 x 42	70	122.10	6.98	\$2420	\$134
BRT42P2478L	24 x 78 x 42	70	115.58	6.69	\$2361	\$125
BRT42P2472L	24 x 72 x 42	70	109.06	6.39	\$2298	\$120
BRT42P2466L	24 x 66 x 42	70	102.54	6.18	\$2253	\$116
BRT42P2460L	24 x 60 x 42	70	96.02	5.97	\$2203	\$111
BRT42P2454L	24 x 54 x 42	70	89.50	5.75	\$2132	\$96
BRT42P2448L	24 x 48 x 42	85	82.98	5.54	\$2023	\$87
BRT42P2442L	24 x 42 x 42	85	77.46	5.32	\$1951	\$73
BRT42P2436L	24 x 36 x 42	85	69.94	5.11	\$1890	\$58

BRT42P3084L	30 x 84 x 42	70	149.53	7.92	\$2774	\$144
BRT42P3078L	30 x 78 x 42	70	141.38	7.55	\$2695	\$129
BRT42P3072L	30 x 72 x 42	70	133.23	7.19	\$2627	\$125
BRT42P3066L	30 x 66 x 42	70	125.08	6.92	\$2563	\$125
BRT42P3060L	30 x 60 x 42	70	116.93	6.66	\$2509	\$116
BRT42P3054L	30 x 54 x 42	70	108.78	6.39	\$2440	\$96
BRT42P3048L	30 x 48 x 42	70	100.63	6.13	\$2336	\$96
BRT42P3042L	30 x 42 x 42	70	92.48	5.86	\$2281	\$91
BRT42P3036L	30 x 36 x 42	70	85.33	5.60	\$2184	\$67

BRT42P3684L	36 x 84 x 42	70	163.39	9.69	\$3110	\$163
BRT42P3678L	36 x 78 x 42	70	154.24	9.28	\$3029	\$154
BRT42P3672L	36 x 72 x 42	70	146.09	8.88	\$2941	\$144
BRT42P3666L	36 x 66 x 42	70	136.94	8.57	\$2859	\$134
BRT42P3660L	36 x 60 x 42	70	127.79	8.26	\$2770	\$120
BRT42P3654L	36 x 54 x 42	70	119.64	7.96	\$2680	\$111
BRT42P3648L	36 x 48 x 42	85	110.49	7.65	\$2559	\$96
BRT42P3642L	36 x 42 x 42	85	101.34	7.34	\$2476	\$87

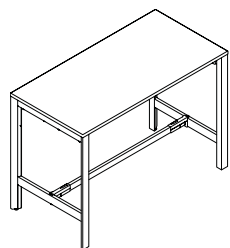

42" H Pod with Levelers

Single table assembly consists of one worksurface, two H leg assemblies, horizontal structural beams and one bottom table beam.

- 24"D tables include 3 horizontal structural beams. 30"/36"D tables include 4 horizontal structural beams.
- Anodized Aluminum Leg - Add **\$113**. list upcharge

BRT42A2484L	24 x 84 x 42	70	107.31	5.02	\$1943	\$134
BRT42A2478L	24 x 78 x 42	70	100.79	4.73	\$1884	\$125
BRT42A2472L	24 x 72 x 42	70	94.27	4.43	\$1823	\$120
BRT42A2466L	24 x 66 x 42	70	87.75	4.22	\$1777	\$116
BRT42A2460L	24 x 60 x 42	70	81.23	4.01	\$1727	\$111
BRT42A2454L	24 x 54 x 42	70	74.71	3.79	\$1656	\$96
BRT42A2448L	24 x 48 x 42	70	68.19	3.58	\$1548	\$87
BRT42A2442L	24 x 42 x 42	70	62.67	3.36	\$1414	\$73
BRT42A2436L	24 x 36 x 42	70	55.15	3.15	\$2770	\$58

BRT42A3084L	30 x 84 x 42	65	132.72	5.86	\$2268	\$144
BRT42A3078L	30 x 78 x 42	65	124.57	5.49	\$2189	\$129
BRT42A3072L	30 x 72 x 42	65	116.42	5.13	\$2120	\$125
BRT42A3066L	30 x 66 x 42	70	108.27	4.86	\$2056	\$125
BRT42A3060L	30 x 60 x 42	70	100.12	4.60	\$2002	\$116
BRT42A3054L	30 x 54 x 42	70	91.97	4.33	\$1934	\$96
BRT42A3048L	30 x 48 x 42	70	83.82	4.07	\$1829	\$96
BRT42A3042L	30 x 42 x 42	70	75.67	3.80	\$1774	\$91
BRT42A3036L	30 x 36 x 42	70	68.52	3.54	\$1677	\$67

BRT42A3684L	36 x 84 x 42	70	114.65	7.04	\$2535	\$163
BRT42A3678L	36 x 78 x 42	70	135.50	6.63	\$2455	\$154
BRT42A3672L	36 x 72 x 42	70	127.35	6.23	\$2367	\$144
BRT42A3666L	36 x 66 x 42	70	118.20	5.92	\$2285	\$134
BRT42A3660L	36 x 60 x 42	70	109.05	5.61	\$2196	\$120
BRT42A3654L	36 x 54 x 42	70	100.90	5.31	\$2106	\$111
BRT42A3648L	36 x 48 x 42	70	91.75	5	\$1985	\$96
BRT42A3642L	36 x 42 x 42	70	82.60	4.69	\$1901	\$87

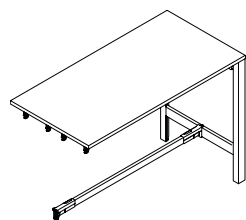

42" H Add-On with Levelers

Single table assembly consists of one worksurface, one H leg assembly, horizontal structural beams, and one bottom table beam.

- 24"D tables include 3 horizontal structural beams. 30"/36"D tables include 4 horizontal structural beams.
- Anodized Aluminum Leg - Add **\$56**. list upcharge

Required Specifications

Top finish
Edge finish
Metal finish (legs)

Optional Specifications

Anodized Aluminum Leg
HP laminate

ROUND LEG PACKAGES

MODEL#	DIMENSIONS	FREIGHT CLASS	WT/LBS.	CUBIC FT.	LIST PRICE	HP ADD
	D x W x H					
BRTS1P2484LR	24 x 84 x 29	70	75	4.92	\$1204	\$113
BRTS1P2478LR	24 x 78 x 29	85	72	4.82	\$1169	\$108
BRTS1P2472LR	24 x 72 x 29	85	69	4.73	\$1138	\$105
BRTS1P2466LR	24 x 66 x 29	85	66	4.65	\$1118	\$99
BRTS1P2463LR	24 x 62.5 x 29	85	63	4.57	\$1109	\$96
BRTS1P2460LR	24 x 60 x 29	85	60	4.48	\$1097	\$95
BRTS1P2454LR	24 x 54 x 29	85	57	4.40	\$1075	\$68
BRTS1P2451LR	24 x 50.5 x 29	85	54	4.30	\$1033	\$64
BRTS1P2448LR	24 x 48 x 29	85	51	4.20	\$1006	\$75
BRTS1P2442LR	24 x 42 x 29	92.5	48	4.10	\$964	\$47
BRTS1P2436LR	24 x 36 x 29	92.5	45	4	\$932	\$32

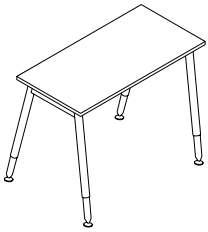

**Single Line 1 Person Pod with Levelers
Round Leg**

BRTS1P3084LR	30 x 84 x 29	70	75	4.92	\$1232	\$121
BRTS1P3078LR	30 x 78 x 29	85	72	4.82	\$1185	\$112
BRTS1P3072LR	30 x 72 x 29	85	69	4.73	\$1156	\$94
BRTS1P3066LR	30 x 66 x 29	85	66	4.65	\$1129	\$105
BRTS1P3063LR	30 x 62.5 x 29	85	63	4.57	\$1121	\$102
BRTS1P3060LR	30 x 60 x 29	85	60	4.48	\$1110	\$84
BRTS1P3054LR	30 x 54 x 29	85	57	4.40	\$1083	\$83
BRTS1P3051LR	30 x 50.5 x 29	85	54	4.30	\$1064	\$86
BRTS1P3048LR	30 x 48 x 29	85	51	4.20	\$1032	\$83
BRTS1P3042LR	30 x 42 x 29	92.5	48	4.10	\$1010	\$81
BRTS1P3036LR	30 x 36 x 29	92.5	45	4	\$904	\$57

Single Line Table Assemblies consist of one worksurface, two leg assemblies, and one supporting structural beam.

BRTS1P2484CR	24 x 84 x 29	70	75	4.92	\$1272	\$113
BRTS1P2478CR	24 x 78 x 29	85	72	4.82	\$1238	\$108
BRTS1P2472CR	24 x 72 x 29	85	69	4.73	\$1206	\$105
BRTS1P2466CR	24 x 66 x 29	85	66	4.65	\$1187	\$99
BRTS1P2463CR	24 x 62.5 x 29	85	63	4.57	\$1178	\$96
BRTS1P2460CR	24 x 60 x 29	85	60	4.48	\$1166	\$95
BRTS1P2454CR	24 x 54 x 29	85	57	4.40	\$1143	\$68
BRTS1P2451CR	24 x 50.5 x 29	85	54	4.30	\$1102	\$64
BRTS1P2448CR	24 x 48 x 29	85	51	4.20	\$1075	\$75
BRTS1P2442CR	24 x 42 x 29	92.5	48	4.10	\$1032	\$47
BRTS1P2436CR	24 x 36 x 29	92.5	45	4	\$1001	\$32

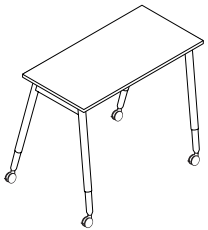

**Single Line 1 Person Pod with Casters
Round Leg**

BRTS1P3084CR	30 x 84 x 29	70	75	4.92	\$1300	\$121
BRTS1P3078CR	30 x 78 x 29	85	72	4.82	\$1253	\$112
BRTS1P3072CR	30 x 72 x 29	85	69	4.73	\$1227	\$92
BRTS1P3066CR	30 x 66 x 29	85	66	4.65	\$1197	\$105
BRTS1P3063CR	30 x 62.5 x 29	85	63	4.57	\$1189	\$102
BRTS1P3060CR	30 x 60 x 29	85	60	4.48	\$1178	\$84
BRTS1P3054CR	30 x 54 x 29	85	57	4.40	\$1152	\$83
BRTS1P3051CR	30 x 50.5 x 29	85	54	4.30	\$1132	\$86
BRTS1P3048CR	30 x 48 x 29	85	51	4.20	\$1101	\$83
BRTS1P3042CR	30 x 42 x 29	92.5	48	4.10	\$1078	\$81
BRTS1P3036CR	30 x 36 x 29	92.5	45	4	\$973	\$57

Single Line Table Assemblies consist of one worksurface, two leg assemblies, and one supporting structural beam. 40mm locking casters with grey tires; steel horizontal beams, aluminum legs.

Required Specifications

Top finish
Edge finish
Metal finish (legs)

Optional Specifications

Anodized Aluminum Leg
HP laminate

ROUND LEG PACKAGES

MODEL#	DIMENSIONS	FREIGHT CLASS	WT./LBS.	CUBIC FT.	LIST PRICE	HP ADD
--------	------------	---------------	----------	-----------	------------	--------

D x W x H

BRTS2P2484LR	24 x 168 x 29	70	149	7.41	\$2113	\$214
BRTS2P2478LR	24 x 156 x 29	70	140	7.27	\$2032	\$214
BRTS2P2472LR	24 x 144 x 29	70	131	7.13	\$1969	\$208
BRTS2P2466LR	24 x 132 x 29	70	122	6.95	\$1935	\$190
BRTS2P2460LR	24 x 120 x 29	70	113	6.71	\$1890	\$190
BRTS2P2454LR	24 x 108 x 29	70	104	6.45	\$1814	\$165
BRTS2P2448LR	24 x 96 x 29	70	95	6.21	\$1706	\$148

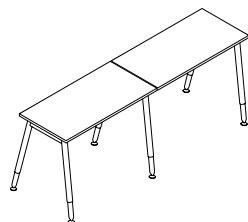

Single Line 2 Person Pod with Levelers Round Leg

BRTS2P3084LR	30 x 168 x 29	70	173	8.25	\$2158	\$242
BRTS2P3078LR	30 x 156 x 29	70	164	7.97	\$2064	\$222
BRTS2P3072LR	30 x 144 x 29	70	155	7.69	\$2006	\$216
BRTS2P3066LR	30 x 132 x 29	70	140	7.41	\$1952	\$208
BRTS2P3060LR	30 x 120 x 29	70	131	7.13	\$1915	\$196
BRTS2P3054LR	30 x 108 x 29	70	122	6.85	\$1861	\$165
BRTS2P3048LR	30 x 96 x 29	70	113	6.57	\$1787	\$165

Single Line 2 Person workstation consists of two worksurfaces, three leg assemblies, and two supporting structural beams. One leg can be shared by 2 adjoining worksurfaces.

BRTS3P2484LR	24 x 252 x 29	70	219	9.74	\$3000	\$336
BRTS3P2478LR	24 x 234 x 29	70	206	9.53	\$2896	\$319
BRTS3P2472LR	24 x 216 x 29	70	192	9.32	\$2801	\$311
BRTS3P2466LR	24 x 198 x 29	70	179	9.11	\$2742	\$294
BRTS3P2460LR	24 x 180 x 29	70	165	8.89	\$2682	\$285
BRTS3P2454LR	24 x 162 x 29	70	152	8.68	\$2569	\$246
BRTS3P2448LR	24 x 144 x 29	70	138	8.47	\$2407	\$220

BRTS3P3084LR	30 x 263 x 29	65	263	11.59	\$3085	\$362
BRTS3P3078LR	30 x 234 x 29	70	246	11.16	\$2943	\$333
BRTS3P3072LR	30 x 216 x 29	70	229	10.72	\$2857	\$325
BRTS3P3066LR	30 x 198 x 29	70	212	10.30	\$2776	\$311
BRTS3P3060LR	30 x 180 x 29	70	195	9.87	\$2720	\$294
BRTS3P3054LR	30 x 162 x 29	70	178	9.44	\$2638	\$246
BRTS3P3048LR	30 x 144 x 29	70	161	9.01	\$2527	\$246

Single Line 3 Person workstation consists of three worksurfaces, four leg assemblies, and three supporting structural beams. One leg can be shared by 2 adjoining worksurfaces.

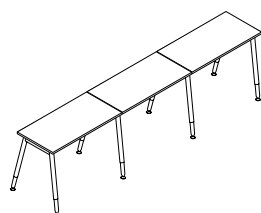

Single Line 3 Person Pod with Levelers Round Leg

BRTS4P2484LR	24 x 336 x 29	70	291	13.67	\$3897	\$449
BRTS4P2478LR	24 x 312 x 29	70	273	13.18	\$3760	\$426
BRTS4P2472LR	24 x 288 x 29	70	254	12.69	\$3634	\$414
BRTS4P2466LR	24 x 264 x 29	70	236	12.20	\$3553	\$391
BRTS4P2460LR	24 x 240 x 29	70	217	11.71	\$3461	\$391
BRTS4P2454LR	24 x 216 x 29	70	199	11.22	\$3324	\$328
BRTS4P2448LR	24 x 192 x 29	70	180	10.73	\$3072	\$328

BRTS4P3084LR	30 x 336 x 29	65	345	14.87	\$4011	\$483
BRTS4P3078LR	30 x 312 x 29	65	323	14.30	\$3823	\$442
BRTS4P3072LR	30 x 288 x 29	70	301	13.73	\$3708	\$431
BRTS4P3066LR	30 x 264 x 29	70	279	13.16	\$3599	\$414
BRTS4P3060LR	30 x 240 x 29	70	257	12.59	\$3524	\$391
BRTS4P3054LR	30 x 216 x 29	70	235	12.02	\$3416	\$328
BRTS4P3048LR	30 x 192 x 29	70	213	11.45	\$3267	\$328

Single Line 4 Person workstation consists of four worksurfaces, five leg assemblies, and four supporting structural beams. One leg can be shared by 2 adjoining worksurfaces.

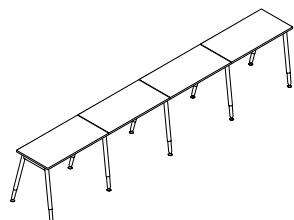

Single Line 4 Person Pod with Levelers Round Leg

Required Specifications

Top finish
Edge finish
Metal finish (legs)

Optional Specifications

Anodized Aluminum Leg
HP laminate

ROUND LEG PACKAGES

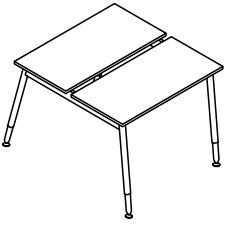

Back-to-Back 2 Person Pod with Levelers Round Leg

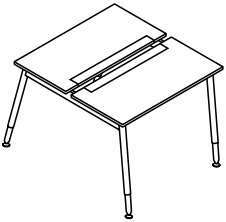

Back-to-Back 2 Person Pod with Access Door and Levelers, Round Leg

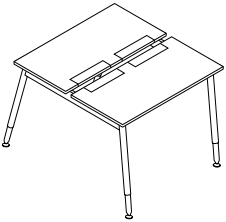

Back-to-Back 2 Person Pod with Access Door and Levelers, Round Leg

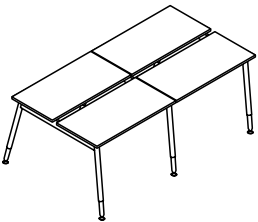

Back-to-Back 4 Person Pod with Levelers Round Leg

MODEL#	DIMENSIONS D x W x H	FREIGHT CLASS	WT./LBS.	CUBIC FT.	LIST PRICE	HP ADD
BRTBAR2P2484LR	50.5 x 84 x 29	70	146	9.40	\$1966	\$225
BRTBAR2P2478LR	50.5 x 78 x 29	85	137	9.20	\$1912	\$214
BRTBAR2P2472LR	50.5 x 72 x 29	85	128	9.02	\$1849	\$208
BRTBAR2P2466LR	50.5 x 66 x 29	85	119	8.76	\$1808	\$196
BRTBAR2P2460LR	50.5 x 60 x 29	85	110	8.56	\$1769	\$190
BRTBAR2P3084LR	62.5 x 84 x 29	70	174	10.40	\$2038	\$242
BRTBAR2P3078LR	62.5 x 78 x 29	70	163	9.80	\$1944	\$222
BRTBAR2P3072LR	62.5 x 72 x 29	70	152	9.54	\$1886	\$208
BRTBAR2P3066LR	62.5 x 66 x 29	70	141	9.25	\$1832	\$208
BRTBAR2P3060LR	62.5 x 60 x 29	85	130	9	\$1645	\$345

Back-to-back 2 Person workstation consists of two worksurfaces, two back-to-back leg assemblies, and two supporting structural beams.

BRTBAR2PA2484LR	50.5 x 84 x 29	70	146	9.40	\$2067	\$402
BRTBAR2PA2478LR	50.5 x 78 x 29	85	137	9.20	\$2023	\$360
BRTBAR2PA2472LR	50.5 x 72 x 29	85	128	9.02	\$1981	\$345
BRTBAR2PA2466LR	50.5 x 66 x 29	85	119	8.76	\$1909	\$302
BRTBAR2PA2460LR	50.5 x 60 x 29	85	110	8.56	\$1837	\$273
BRTBAR2PA3084LR	62.5 x 84 x 29	70	174	10.40	\$2239	\$489
BRTBAR2PA3078LR	62.5 x 78 x 29	70	163	9.80	\$2168	\$460
BRTBAR2PA3072LR	62.5 x 72 x 29	70	152	9.54	\$2123	\$418
BRTBAR2PA3066LR	62.5 x 66 x 29	70	141	9.25	\$2052	\$373
BRTBAR2PA3060LR	62.5 x 60 x 29	85	130	9	\$1952	\$345

Back-to-back 2 Person workstation consists of two worksurfaces, two back-to-back leg assemblies, and two supporting structural beams. Anodized aluminum worksurface door provides access to power/data trough below worksurface. Worksurface with access doors CANNOT be combined with above worksurface power trough.

BRTBAR2PDA2484LR	50.5 x 84 x 29	70	146	9.40	\$2229	\$433
BRTBAR2PDA2478LR	50.5 x 78 x 29	85	137	9.20	\$2184	\$386
BRTBAR2PDA2472LR	50.5 x 72 x 29	85	128	9.02	\$2136	\$371
BRTBAR2PDA2466LR	50.5 x 66 x 29	85	119	8.76	\$2060	\$324
BRTBAR2PDA2460LR	50.5 x 60 x 29	85	110	8.56	\$1983	\$295
BRTBAR2PDA3084LR	62.5 x 84 x 29	70	174	10.40	\$2415	\$525
BRTBAR2PDA3078LR	62.5 x 78 x 29	70	163	9.80	\$2339	\$493
BRTBAR2PDA3072LR	62.5 x 72 x 29	70	152	9.54	\$2290	\$450
BRTBAR2PDA3066LR	62.5 x 66 x 29	70	141	9.25	\$2214	\$401
BRTBAR2PDA3060LR	62.5 x 60 x 29	85	130	9	\$2105	\$372

Back-to-back 2 Person workstation consists of two worksurfaces, two back-to-back leg assemblies, and two supporting structural beams. These tables feature dual access doors providing a central connection point for monitor lifts. Anodized aluminum worksurface door provides access to power/data trough below worksurface. Worksurface with access doors CANNOT be combined with above worksurface power trough.

BRTBAR4P2484LR	50.5 x 168 x 29	70	272	15.66	\$3564	\$449
BRTBAR4P2478LR	50.5 x 156 x 29	70	256	15.20	\$3427	\$426
BRTBAR4P2472LR	50.5 x 144 x 29	70	240	14.74	\$3301	\$414
BRTBAR4P2466LR	50.5 x 132 x 29	70	224	14.28	\$3221	\$391
BRTBAR4P2460LR	50.5 x 120 x 29	70	208	13.82	\$3141	\$380
BRTBAR4P3084LR	62.5 x 168 x 29	70	333	16.86	\$3680	\$483
BRTBAR4P3078LR	62.5 x 156 x 29	70	313	16.32	\$3490	\$442
BRTBAR4P3072LR	62.5 x 144 x 29	70	293	15.78	\$3376	\$431
BRTBAR4P3066LR	62.5 x 132 x 29	70	273	15.24	\$3238	\$414
BRTBAR4P3060LR	62.5 x 120 x 29	70	253	14.70	\$3221	\$391

Back-to-back 4 Person workstation consists of four worksurfaces, three back-to-back outer leg assemblies, and four supporting structural beams.

Required Specifications

Top finish
Edge finish
Metal finish (legs)

Optional Specifications

Anodized Aluminum Leg
HP laminate

ROUND LEG PACKAGES

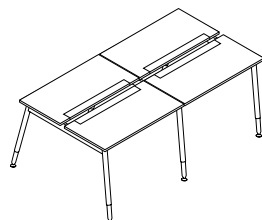

Back-to-Back 4 Person Pod with Access Door and Levelers, Round Leg

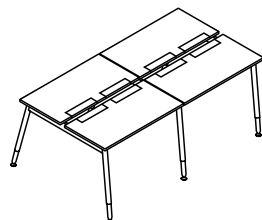

Back-to-Back 4 Person Pod with Access Door and Levelers, Round Leg

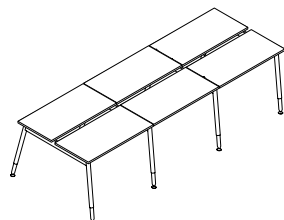

Back-to-Back 6 Person Pod with Levelers Round Leg

MODEL#	DIMENSIONS D x W x H	FREIGHT CLASS	WT/LBS.	CUBIC FT.	LIST PRICE	HP ADD
BRTBAR4PA2484LR	50.5 x 168 x 29	70	272	15.66	\$3668	\$804
BRTBAR4PA2478LR	50.5 x 156 x 29	70	256	15.20	\$3553	\$717
BRTBAR4PA2472LR	50.5 x 144 x 29	70	240	14.74	\$3467	\$689
BRTBAR4PA2466LR	50.5 x 132 x 29	70	224	14.28	\$3324	\$603
BRTBAR4PA2460LR	50.5 x 120 x 29	70	208	13.82	\$3180	\$546
BRTBAR4PA3084LR	62.5 x 168 x 29	70	333	16.86	\$4011	\$975
BRTBAR4PA3078LR	62.5 x 156 x 29	70	313	16.32	\$3868	\$918
BRTBAR4PA3072LR	62.5 x 144 x 29	70	293	15.78	\$3783	\$833
BRTBAR4PA3066LR	62.5 x 132 x 29	70	273	15.24	\$3639	\$746
BRTBAR4PA3060LR	62.5 x 120 x 29	70	253	14.70	\$3439	\$689

Back-to-back 4 Person workstation consists of four worksurfaces, three back-to-back outer leg assemblies, and four supporting structural beams. Anodized aluminum worksurface door provides access to power/data trough below worksurface. Worksurface with access doors CANNOT be combined with above worksurface power trough.

BRTBAR4PDA2484LR	50.5 x 168 x 29	70	272	15.66	\$4062	\$863
BRTBAR4PDA2478LR	50.5 x 156 x 29	70	256	15.20	\$3938	\$771
BRTBAR4PDA2472LR	50.5 x 144 x 29	70	240	14.74	\$3845	\$740
BRTBAR4PDA2466LR	50.5 x 132 x 29	70	224	14.28	\$3760	\$648
BRTBAR4PDA2460LR	50.5 x 120 x 29	70	208	13.82	\$3536	\$586
BRTBAR4PDA3084LR	62.5 x 168 x 29	70	333	16.86	\$4401	\$1048
BRTBAR4PDA3078LR	62.5 x 156 x 29	70	313	16.32	\$4247	\$986
BRTBAR4PDA3072LR	62.5 x 144 x 29	70	293	15.78	\$4153	\$892
BRTBAR4PDA3066LR	62.5 x 132 x 29	70	273	15.24	\$4062	\$739
BRTBAR4PDA3060LR	62.5 x 120 x 29	70	253	14.70	\$3815	\$740

Back-to-back 4 Person workstation consists of four worksurfaces, three back-to-back outer leg assemblies, and four supporting structural beams. These tables feature dual access doors providing a central connection point for monitor lifts. Anodized aluminum worksurface door provides access to power/data trough below worksurface. Worksurface with access doors CANNOT be combined with above worksurface power trough.

BRTBAR6P2484LR	50.5 x 252 x 29	70	434	22.88	\$5148	\$672
BRTBAR6P2478LR	50.5 x 234 x 29	70	409	22.10	\$4942	\$637
BRTBAR6P2472LR	50.5 x 216 x 29	70	359	21.32	\$4754	\$621
BRTBAR6P2466LR	50.5 x 198 x 29	70	329	20.54	\$4633	\$586
BRTBAR6P2460LR	50.5 x 180 x 29	70	308	19.76	\$4513	\$577
BRTBAR6P3084LR	62.5 x 252 x 29	70	493	24.53	\$5330	\$714
BRTBAR6P3078LR	62.5 x 234 x 29	70	462	23.75	\$5037	\$663
BRTBAR6P3072LR	62.5 x 216 x 29	70	431	22.86	\$4865	\$646
BRTBAR6P3066LR	62.5 x 198 x 29	70	400	21.97	\$4701	\$621
BRTBAR6P3060LR	62.5 x 180 x 29	70	369	21.08	\$4590	\$586

Back-to-back 6 Person workstation consists of six worksurfaces, four back-to-back outer leg assemblies, and six supporting structural beams.

Required Specifications

Top finish
Edge finish
Metal finish (legs)

Optional Specifications

Anodized Aluminum Leg
HP laminate

ROUND LEG PACKAGES

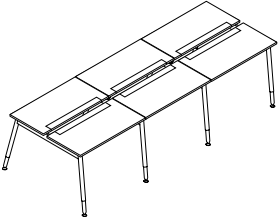

Back-to-Back 6 Person Pod with Access Door and Levelers, Round Leg

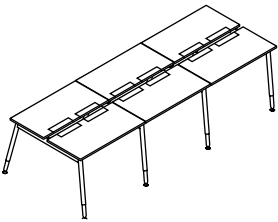

Back-to-Back 6 Person Pod with Access Door and Levelers, Round Leg

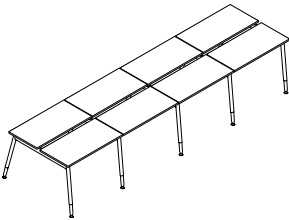

Back-to-Back 8 Person Pod with Levelers Round Leg

MODEL#	DIMENSIONS D x W x H	FREIGHT CLASS	WT/LBS.	CUBIC FT.	LIST PRICE	HP ADD
BRTBAR6PA2484LR	50.5 x 252 x 29	70	434	22.88	\$5450	\$1205
BRTBAR6PA2478LR	50.5 x 234 x 29	70	409	22.10	\$5277	\$1076
BRTBAR6PA2472LR	50.5 x 216 x 29	70	359	21.32	\$5148	\$1033
BRTBAR6PA2466LR	50.5 x 198 x 29	70	329	20.54	\$4933	\$904
BRTBAR6PA2460LR	50.5 x 180 x 29	70	308	19.76	\$4719	\$817
BRTBAR6PA3084LR	62.5 x 252 x 29	70	493	24.53	\$5923	\$1462
BRTBAR6PA3078LR	62.5 x 234 x 29	70	462	23.75	\$5708	\$1377
BRTBAR6PA3072LR	62.5 x 216 x 29	70	431	22.86	\$5579	\$1248
BRTBAR6PA3066LR	62.5 x 198 x 29	70	400	21.97	\$5364	\$1119
BRTBAR6PA3060LR	62.5 x 180 x 29	70	369	21.08	\$5063	\$1033

Back-to-back 6 Person workstation consists of six worksurfaces, four back-to-back leg assemblies, and six supporting structural beams. Anodized aluminum worksurface door provides access to power/data trough below worksurface. Worksurface with access doors CANNOT be combined with above worksurface power trough.

BRTBAR6PDA2484LR	50.5 x 252 x 29	70	434	22.88	\$5880	\$1292
BRTBAR6PDA2478LR	50.5 x 234 x 29	70	409	22.10	\$5693	\$1155
BRTBAR6PDA2472LR	50.5 x 216 x 29	70	359	21.32	\$5555	\$1109
BRTBAR6PDA2466LR	50.5 x 198 x 29	70	329	20.54	\$5321	\$973
BRTBAR6PDA2460LR	50.5 x 180 x 29	70	308	19.76	\$5093	\$877
BRTBAR6PDA3084LR	62.5 x 252 x 29	70	493	24.53	\$6389	\$1571
BRTBAR6PDA3078LR	62.5 x 234 x 29	70	462	23.75	\$6158	\$1476
BRTBAR6PDA3072LR	62.5 x 216 x 29	70	431	22.86	\$6019	\$1338
BRTBAR6PDA3066LR	62.5 x 198 x 29	70	400	21.97	\$5785	\$1203
BRTBAR6PDA3060LR	62.5 x 180 x 29	70	369	21.08	\$5463	\$1108

Back-to-back 6 Person workstation consists of six worksurfaces, four back-to-back leg assemblies, and six supporting structural beams. These tables feature dual access doors providing a central connection point for monitor lifts. Anodized aluminum worksurface door provides access to power/data trough below worksurface. Worksurface with access doors CANNOT be combined with above worksurface power trough.

BRTBAR8P2484LR	50.5 x 336 x 29	70	556	28.30	\$6744	\$883
BRTBAR8P2478LR	50.5 x 312 x 29	70	520	27.30	\$6458	\$849
BRTBAR8P2472LR	50.5 x 288 x 29	70	484	26.30	\$6205	\$826
BRTBAR8P2466LR	50.5 x 264 x 29	70	448	25.30	\$6045	\$780
BRTBAR8P2460LR	50.5 x 240 x 29	70	412	24.42	\$5885	\$758
BRTBAR8P3084LR	62.5 x 336 x 29	70	669	30.58	\$6962	\$965
BRTBAR8P3078LR	62.5 x 312 x 29	70	625	29.48	\$6583	\$883
BRTBAR8P3072LR	62.5 x 288 x 29	70	581	28.38	\$6355	\$861
BRTBAR8P3066LR	62.5 x 264 x 29	70	536	27.28	\$6137	\$826
BRTBAR8P3060LR	62.5 x 240 x 29	70	492	26.18	\$5989	\$780

Back-to-back 8 Person workstation consists of eight worksurfaces, five back-to-back leg assemblies, and eight supporting structural beams.

Required Specifications

Top finish
Edge finish
Metal finish (legs)

Optional Specifications

Anodized Aluminum Leg
HP laminate

ROUND LEG PACKAGES

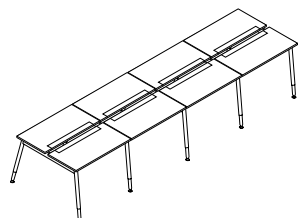

Back-to-Back 8 Person Pod with Access Door and Levelers, Round Leg

MODEL#	DIMENSIONS D x W x H	FREIGHT CLASS	WT/LBS.	CUBIC FT.	LIST PRICE	HP ADD
BRTBAR8PA2484LR	50.5 x 336 x 29	70	556	28.30	\$7134	\$1605
BRTBAR8PA2478LR	50.5 x 312 x 29	70	520	27.30	\$6905	\$1433
BRTBAR8PA2472LR	50.5 x 288 x 29	70	484	26.30	\$6733	\$1377
BRTBAR8PA2466LR	50.5 x 264 x 29	70	448	25.30	\$6446	\$1205
BRTBAR8PA2460LR	50.5 x 240 x 29	70	412	24.42	\$6160	\$1090
BRTBAR8PA3084LR	62.5 x 336 x 29	70	669	30.58	\$7764	\$1949
BRTBAR8PA3078LR	62.5 x 312 x 29	70	625	29.48	\$7477	\$1835
BRTBAR8PA3072LR	62.5 x 288 x 29	70	581	28.38	\$7305	\$1663
BRTBAR8PA3066LR	62.5 x 264 x 29	70	536	27.28	\$7019	\$1491
BRTBAR8PA3060LR	62.5 x 240 x 29	70	492	26.18	\$6618	\$1377

Back-to-back 8 Person workstation consists of eight worksurfaces, five back-to-back leg assemblies, and eight supporting structural beams. Anodized aluminum worksurface door provides access to power/data trough below worksurface. Worksurface with access doors CANNOT be combined with above worksurface power trough.

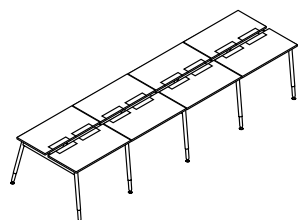

Back-to-Back 8 Person Pod with Access Door and Levelers, Round Leg

BRTBAR8PDA2484LR	50.5 x 336 x 29	70	556	28.30	\$7696	\$1725
BRTBAR8PDA2478LR	50.5 x 312 x 29	70	520	27.30	\$7449	\$1539
BRTBAR8PDA2472LR	50.5 x 288 x 29	70	484	26.30	\$7265	\$1476
BRTBAR8PDA2466LR	50.5 x 264 x 29	70	448	25.30	\$6955	\$1294
BRTBAR8PDA2460LR	50.5 x 240 x 29	70	412	24.42	\$6646	\$1171
BRTBAR8PDA3084LR	62.5 x 336 x 29	70	669	30.58	\$8376	\$2094
BRTBAR8PDA3078LR	62.5 x 312 x 29	70	625	29.48	\$8066	\$1972
BRTBAR8PDA3072LR	62.5 x 288 x 29	70	581	28.38	\$7881	\$1788
BRTBAR8PDA3066LR	62.5 x 264 x 29	70	536	27.28	\$7574	\$1601
BRTBAR8PDA3060LR	62.5 x 240 x 29	70	492	26.18	\$7140	\$1478

Back-to-back 8 Person workstation consists of eight worksurfaces, five back-to-back leg assemblies, and eight supporting structural beams. These tables feature dual access doors providing a central connection point for monitor lifts. Anodized aluminum worksurface door provides access to power/data trough below worksurface. Worksurface with access doors CANNOT be combined with above worksurface power trough.

RETURNS

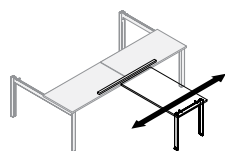

Rail Sliding Table Kit - Rectangular Legs

BRTSLDT72C	72 x 48 x 29	92.5	28.50	2.40	\$574	N/A
------------	--------------	------	-------	------	--------------	-----

Includes leg, leg support, sliding bracket hardware, 72" rail and hardware to secure table. **Worksurface not included.** Legs are for 24" d worksurfaces. 40mm dia. locking casters with 8mm thread, white body and grey tires. Maximum length of sliding table surface is 48". **Cannot be used on single line pods with rectangular legs.**

- Anodized Aluminum Leg - Add **\$56.** list upcharge

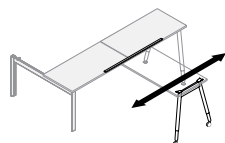

Rail Sliding Table Kit - Round Legs

BRTSLDT72CR	72 x 48 x 29	92.5	28.50	2.40	\$574	N/A
-------------	--------------	------	-------	------	--------------	-----

Includes leg, leg support, sliding bracket hardware, 72" rail and hardware to secure table. **Worksurface not included.** Legs are for 24" d worksurfaces. 3" dia. locking casters are standard. Maximum length of sliding table surface is 48".

Required Specifications

Top finish
Edge finish
Metal finish (legs)

Optional Specifications

Anodized Aluminum Leg
HP laminate

MEETING TABLES

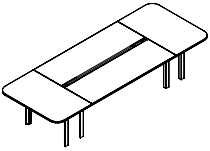

Boardroom Table with Rectangular Leg and Levelers

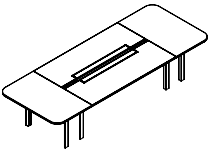

Boardroom Table with Rectangular Leg, Access Door and Levelers

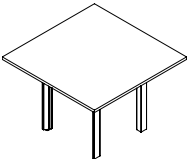

Square Meeting Table with Rectangular Legs

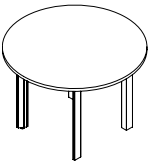

Round Meeting Table with Rectangular Legs

MODEL#	DIMENSIONS D x W x H	FREIGHT CLASS	WT./LBS.	CUBIC FT.	LIST PRICE	HP ADD
BRTBRDP276L	52.5 x 276 x 29	70	474	23.42	\$6266	\$783
BRTBRDP240L	52.5 x 240 x 29	70	408	22.64	\$6026	\$732
BRTBRDP204L	52.5 x 204 x 29	70	340	20.74	\$4883	\$577
BRTBRDP180L	52.5 x 180 x 29	70	308	19.82	\$4722	\$543
BRTBRDP132L	52.5 x 132 x 29	70	228	15.02	\$3511	\$371
BRTBRDP120L	52.5 x 120 x 29	85	210	14.56	\$3430	\$354

Boardroom Table assemblies consist of 2 or more back-to-back tables with end tables on either side. Inset support legs, levelers. Worksurfaces, supporting structure and connecting hardware included.

- Anodized Aluminum Leg - Add **\$224** list upcharge
- BRTBRDP276L consists of (6) 24" x 72" back-to-back tables and (2) 30" x 50.5" end tables
- BRTBRDP240L consists of (6) 24" x 60" back-to-back tables and (2) 30" x 50.5" end tables
- BRTBRDP204L consists of (4) 24" x 72" back-to-back tables and (2) 30" x 50.5" end tables
- BRTBRDP180L consists of (4) 24" x 60" back-to-back tables and (2) 30" x 50.5" end tables
- BRTBRDP132L consists of (2) 24" x 72" back-to-back tables and (2) 30" x 50.5" end tables
- BRTBRDP120L consists of (2) 24" x 60" back-to-back tables and (2) 30" x 50.5" end tables

BRTBRDPA276L	52.5 x 276 x 29	70	474	23.42	\$6662	\$1196
BRTBRDPA240L	52.5 x 240 x 29	70	408	22.64	\$6433	\$757
BRTBRDPA204L	52.5 x 204 x 29	70	340	20.74	\$5145	\$623
BRTBRDPA180L	52.5 x 180 x 29	70	308	19.82	\$4859	\$709
BRTBRDPA132L	52.5 x 132 x 29	70	228	15.02	\$3614	\$508
BRTBRDPA120L	52.5 x 120 x 29	85	210	14.56	\$3470	\$436

Boardroom Table assemblies consist of 2 or more back-to-back tables with end tables on either side. Inset support legs, levelers. Worksurfaces, supporting structure and connecting hardware included.

- Anodized Aluminum Leg - Add **\$224** list upcharge
- BRTBRDPA276L consists of (6) 24" x 72" back-to-back tables and (2) 30" x 50.5" end tables
- BRTBRDPA240L consists of (6) 24" x 60" back-to-back tables and (2) 30" x 50.5" end tables
- BRTBRDPA204L consists of (4) 24" x 72" back-to-back tables and (2) 30" x 50.5" end tables
- BRTBRDPA180L consists of (4) 24" x 60" back-to-back tables and (2) 30" x 50.5" end tables
- BRTBRDPA132L consists of (2) 24" x 72" back-to-back tables and (2) 30" x 50.5" end tables
- BRTBRDPA120L consists of (2) 24" x 60" back-to-back tables and (2) 30" x 50.5" end tables

BRTSQ42L	42 x 42 x 29	70	85	4.20	\$1083	\$116
BRTSQ42C	42 x 42 x 29	70	85	4.20	\$1141	\$116

3mm edging. Select BRTSQ42L for levelers or BRTSQ42C for casters.

- Anodized Aluminum Leg - Add **\$113** list upcharge

BRTR42L	42 x 42 x 29	70	65	3.90	\$1083	\$116
BRTR42C	42 x 42 x 29	70	65	3.90	\$1141	\$116

3mm edging. Select BRTR42L for levelers or BRTR42C for casters.

- Anodized Aluminum Leg - Add **\$113** list upcharge

Required Specifications

Top finish
Edge finish
Metal finish (legs)

Optional Specifications

HP laminate
Anodized aluminum leg
Table-edge mounted power module (Meeting Tables)

Below worksurface power trough with power distribution module (Meeting Tables)

LEG ASSEMBLIES

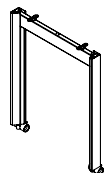

Single Rectangular Leg Assembly with Casters

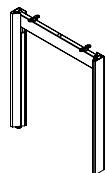

Single Rectangular Leg Assembly with Levelers

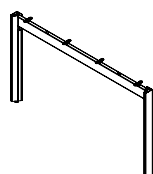

Back-to-Back Rectangular Leg Assembly with Levelers

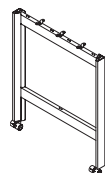

Single H Leg Assembly with Casters

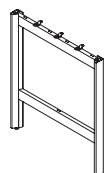

Single H Leg Assembly with Levelers

MODEL#	DIMENSIONS	FREIGHT CLASS	WT./LBS.	CUBIC FT.	LIST PRICE	HP ADD
--------	------------	---------------	----------	-----------	------------	--------

D x W x H

BRTSL24C	24 x 2.5 x 28	150	8	1.34	\$316	N/A
BRTSL30C	30 x 2.5 x 28	150	8	1.41	\$360	N/A
BRTSL36C	36 x 2.5 x 28	150	8	1.81	\$473	N/A

Two single leg assemblies combined with support beams form the structure of the Bridges II series Single Table. One leg can be shared by two adjoining worksurfaces. 40mm white locking casters with grey tires; steel horizontal beams, aluminum legs.

- Anodized Aluminum Leg - Add **\$56** list upcharge

BRTSL24L	24 x 2.5 x 28	150	8	1.34	\$288	N/A
BRTSL30L	30 x 2.5 x 28	150	8	1.34	\$316	N/A
BRTSL36L	36 x 2.5 x 28	125	9	1.50	\$319	N/A

Two single leg assemblies combined with support beams form the structure of the Bridges II series Single Table or Single Line tables. One leg can be shared by two adjoining worksurfaces. Leveling glides; steel horizontal beams, aluminum legs.

- Anodized Aluminum Leg - Add **\$56** list upcharge
- Please specify two beams when using BRTSL36L.

BRTBA34L	34 x 2.5 x 28	150	10	2.47	\$345	N/A
BRTBA51L	50.5 x 2.5 x 28	150	12	2.96	\$373	N/A
BRTBA63L	62.5 x 2.5 x 28	150	13	3.21	\$389	N/A

Two double leg assemblies combined with support beams form the structure of the Bridges II series Back-to-Back Table. One double leg can be shared by four adjoining worksurfaces. Leveling glides; steel horizontal beams, aluminum legs.

- Anodized Aluminum Leg - Add **\$56** list upcharge

BRTHL3624C	24 x 2.5 x 35	100	14	1.68	\$495	N/A
BRTHL3630C	30 x 2.5 x 35	100	16	1.76	\$524	N/A
BRTHL3636C	36 x 2.5 x 35	125	18	2.26	\$593	N/A

BRTHL4224C	24 x 2.5 x 41	125	15	1.96	\$518	N/A
BRTHL4230C	30 x 2.5 x 41	100	17	2.06	\$546	N/A
BRTHL4236C	36 x 2.5 x 41	125	19	2.65	\$615	N/A

Two single leg assemblies combined with support beams form the structure of the Bridges II series Single Line Tables. One leg can be shared by two adjoining worksurfaces. 40mm white locking casters with grey tires; steel horizontal beams, aluminum legs. For proper installation, the following beams are required:

- 24"D legs - 4 beams (3 under the surface and one at the bottom)
- 30"D/36"D legs - 5 beams (4 under the surface and one at the bottom)
- Anodized Aluminum Leg - Add **\$56** list upcharge

BRTHL3624L	24 x 2.5 x 35	100	14	1.68	\$455	N/A
BRTHL3630L	30 x 2.5 x 35	100	16	1.76	\$484	N/A
BRTHL3636L	36 x 2.5 x 35	125	18	2.26	\$553	N/A

BRTHL4224L	24 x 2.5 x 41	125	15	1.96	\$477	N/A
BRTHL4230L	30 x 2.5 x 41	100	17	2.06	\$507	N/A
BRTHL4236L	36 x 2.5 x 41	125	19	2.65	\$575	N/A

Two single leg assemblies combined with support beams form the structure of the Bridges II series Single Line Tables. One leg can be shared by two adjoining worksurfaces. For proper installation, the following beams are required:

- 24"D legs - 4 beams (3 under the surface and one at the bottom)
- 30"D/36"D legs - 5 beams (4 under the surface and one at the bottom)
- Anodized Aluminum Leg - Add **\$56** list upcharge

Required Specifications

Metal finish (legs)

Optional Specifications

Anodized aluminum leg

LEG ASSEMBLIES

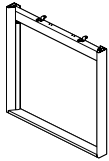

Single Loop Leg

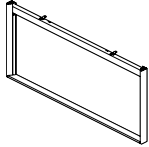

Back-to-Back Loop Leg



120° Rectangular Corner Leg Kit

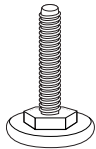

Leveler for Rectangular Leg Table

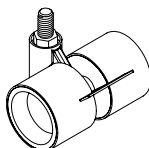

Caster for Rectangular Leg Table



Single Table Round Leg Assembly

MODEL#	DIMENSIONS	FREIGHT CLASS	WT./LBS.	CUBIC FT.	LIST PRICE	HP ADD
--------	------------	---------------	----------	-----------	------------	--------

D x W x H

BRTSLL24L	24 x 2.5 x 28	92.5	11	1.01	\$328	N/A
BRTSLL30L	30 x 2.5 x 28	92.5	13.75	1.26	\$351	N/A
BRTSLL36L	36 x 2.5 x 28	92.5	16.50	1.51	\$377	N/A

Two single leg assemblies combined with support beams form the structure of the Bridges II series Single Line tables. One leg can be shared by two adjoining worksurfaces. Leveling glides; steel horizontal beams, aluminum legs.

- Anodized Aluminum Leg - Add **\$56** list upcharge

BRTBALL51L	50.5 x 2.5 x 28	92.5	23.14	2.12	\$455	N/A
BRTBALL63L	62.5 x 2.5 x 28	92.5	28.64	2.62	\$476	N/A

Two back-to-back leg assemblies form the structure of the Bridges II series Single Line Back-to-Back Table. One double leg can be shared by four adjoining worksurfaces. Leveling glides; steel horizontal beams, aluminum legs.

- Anodized Aluminum Leg - Add **\$56** list upcharge

BRT120L42	34 x 2.5 x 28	250	6.60	2.80	\$660	N/A
-----------	---------------	-----	------	------	--------------	-----

One 120° corner leg kit combined with two single or double leg assemblies and support beams form the structure of the Bridges II 120° Tables. 120° corner leg kit includes one corner leg and adjacent, telescopic beams to support BRTWAC120xxxx or BRTWAC120xxxxA 120° worksurfaces. Telescopic horizontal beams allow single or double leg assemblies to be positioned either under the worksurface (end of a run) or to be shared by adjoining worksurfaces. Levelers, steel horizontal beams, aluminum legs.

- Anodized Aluminum Leg - Add **\$33** list upcharge

BRTLVS	1 x 1 x 2.5	70	.03	.01	\$7	N/A
--------	-------------	----	-----	-----	------------	-----

5/16" thread with black base. Leveler has 2" adjustment range. Casters and levelers on Rectangular legs cannot be interchanged on site.

BRTLCS	2.6 x 2.7 x 2.5	70	.06	.01	\$24	N/A
--------	-----------------	----	-----	-----	-------------	-----

Locking. 40mm diameter with 8mm thread, white body, light grey tires. Casters and levelers on Rectangular legs cannot be interchanged on site.

BRTSL	24 x 3 x 28	125	8	1.25	\$305	N/A
-------	-------------	-----	---	------	--------------	-----

Two single table leg assemblies combined with a single beam form the supporting structure of the Bridges II series Single Line Table. One leg can be shared by two adjoining worksurfaces. Leveling Glides are standard. Locking casters are available on single tables. Specify BRTLCCR

Required Specifications

Top finish
Edge finish
Metal finish (legs)

Optional Specifications

Anodized Aluminum Leg
HP laminate

LEG ASSEMBLIES



**Single Table Round Leg Assembly,
Fixed Height**

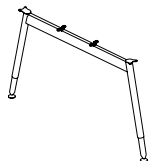

Double Table Round Leg Assembly

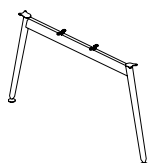

**Double Table Round Leg Assembly,
Fixed Height**

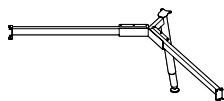

120° Round Corner Leg Assembly

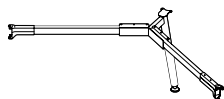

120° Fixed Height Corner Leg Assembly

MODEL#	DIMENSIONS	FREIGHT CLASS	WT/LBS.	CUBIC FT.	LIST PRICE	HP ADD
--------	------------	---------------	---------	-----------	------------	--------

D x W x H

BRTFSL	24 x 2.5 x 28	150	5	.97	\$260	N/A
--------	---------------	-----	---	-----	--------------	-----

Two single table leg assemblies combined with a single beam form the supporting structure of the Bridges II series Single Line Table. One leg can be shared by two adjoining worksurfaces. Leveling glides are standard.

BRTDL	50 x 3 x 28	150	12	2.81	\$397	N/A
-------	-------------	-----	----	------	--------------	-----

Two double table leg assemblies combined with two single beams form the supporting structure of the Bridges II series Back-to-Back Tables. One leg can be shared by two adjoining worksurfaces. Leveling glides are standard.

BRTFDL	50 x 2.5 x 28	250	8	2.03	\$356	N/A
--------	---------------	-----	---	------	--------------	-----

Two double table leg assemblies combined with two single beams form the supporting structure of the Bridges II series Back-to-Back Tables. One leg can be shared by two adjoining worksurfaces. Leveling glides are standard.

BRTCRL42	16 x 18 x 28	92.5	15	1.50	\$611	N/A
----------	--------------	------	----	------	--------------	-----

Provides support for worksurfaces connected at 120°. Single leg and beam assembly for 120° worksurface planning. Works with BRTWAC120xxxx or BRTWAC120xxxxA 120° worksurfaces. For a single application, two BRTSL (single legs) must be added. To join a back-to-back table application, leg assembly will join to existing pod.

- When joining to an existing table, the beam extends to reach the shared leg.

BRTFCRL42	16 x 18 x 28	92.5	13	1.50	\$568	N/A
-----------	--------------	------	----	------	--------------	-----

Provides support for worksurfaces connected at 120°, supported by fixed height legs. Single leg and beam assembly for 120° worksurface planning. Works with BRTWAC120xxxx or BRTWAC120xxxxA 120° worksurfaces. For a single application, two BRTFSL (single legs) must be added. To join a back-to-back table application, leg assembly will join to existing pod.

- When joining to an existing table, the beam extends to reach the shared leg.

Required Specifications

Metal finish (legs)

LEG ASSEMBLIES

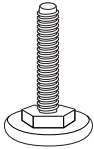

Leveler for Round Leg Table

MODEL#	DIMENSIONS D x W x H	FREIGHT CLASS	WT./LBS.	CUBIC FT.	LIST PRICE	HP ADD
BRTLVR	2.13 x 2.13 x 2	70	.20	.01	\$7	N/A

3/8" thread with black base. Leveler has 1" height adjustment range. Field retrofitable on round leg.



Caster for Round Leg Table

BRTLCR	1.5 x 3 x 3.75	70	.30	.01	\$24	N/A
--------	----------------	----	-----	-----	-------------	-----

Locking. 3" diameter with 3/8" -16 threaded stem. Field retrofitable on round leg.

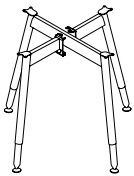

Round Table Leg Assembly

BRTRL	24 x 24 x 28	125	16	2.33	\$629	N/A
-------	--------------	-----	----	------	--------------	-----

Four leg assembly. Leveling Glides are standard. Locking casters are available. Specify (4) BRTLCR. Maximum table diameter is 42". Includes all connecting hardware.

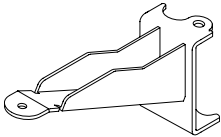

Leg Support Cantilever

BRTLSC	2 x 9 x 5	70	.50	.01	\$108	N/A
--------	-----------	----	-----	-----	--------------	-----

Provides stability for leg supports.

Required Specifications
Metal Finish (legs)

Optional Specifications
Casters (BRTRL)

BEAM APPLICATIONS

D x W x H

Table supporting structures - BEAMS

Legs are connected with supporting beams. There is one beam for a single line of tables while two beams connect back-to-back table structures. Adjustable clamps at either end of the beam can be adjusted to accommodate the following applications in both single table as well as back-to-back table configurations.

STANDARD TABLE BEAM**Single table beam application (1)**

Designed to bridge two legs to form support for a single table, or for two back-to-back worksurfaces. Adjustable clamps at either end of the beam are pushed all the way in to allow both table legs to be tucked under the worksurface.

**End of run table beam application (2)**

Supports one table leg assembly tucked under the worksurface (one adjustable clamp pushed all the way in), while the other table leg assembly can be shared between two adjacent worksurfaces (adjustable clamp pulled out to extend the beam).

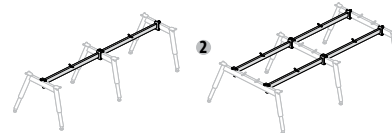
**Interconnecting table beam application (3)**

Supports both table leg assemblies extended to support adjacent worksurfaces on either side. Adjustable clamps at either end of the beam are pushed all the way in to allow both table legs to be tucked under the worksurface. Single table beam application supports single table leg assemblies with legs on both sides tucked under the worksurface.

**TELESCOPIC TABLE BEAM (4)**

Supports a return connected perpendicularly to a 24" or 30" deep primary worksurface. The Telescopic beam is connected to a single or back-to-back leg on one side and to any-worksurface supporting beam on the opposite side. Telescopic beam clamp allows the table leg to be tucked under the worksurface or shared between two adjacent worksurfaces.

**STORAGE TABLE BEAM (5)**

The Storage beam is connected to a single or back-to-back leg on one side and to the worksurface on the opposite side - thus saving one leg assembly. Assembly worksurface is connected to storage units with included storage brackets. Storage table beam's flexibility allows for a single table application (with the table leg tucked in under the worksurface) as well as for a double table installation (two adjacent tables supported by a shared leg in the middle and two storage cabinets at the opposite ends).

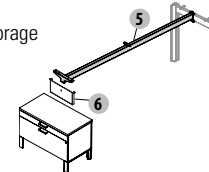
**STORAGE TABLE BEAM ADAPTER (6)**

Connects to a storage table beam. This assembly allows a worksurface to be supported by a leg on one side and a spine (formed by interconnected storage cabinets) on the opposite side.

BEAMS	MODEL#	DIMENSIONS	FREIGHT CLASS	WT/LBS.	CUBIC FT.	LIST PRICE
	BRTSB84C	1 x 79 x 2	60	8.02	.15	\$234
	BRTSB78C	1 x 73 x 2	60	7.38	.12	\$228
	BRTSB72C	1 x 67 x 2	60	6.74	.09	\$221
	BRTSB66C	1 x 61 x 2	60	6.09	.08	\$213
	BRTSB63C	1 x 57.5 x 2	60	5.72	.08	\$210
	BRTSB60C	1 x 55 x 2	60	5.45	.07	\$205
	BRTSB54C	1 x 49 x 2	60	4.86	.06	\$198
	BRTSB51C	1 x 45.5 x 2	60	4.81	.05	\$192
	BRTSB48C	1 x 43 x 2	60	4.60	.05	\$184
	BRTSB42C	1 x 37 x 2	60	3.59	.04	\$177
	BRTSB36C	1 x 31 x 2	60	3.31	.03	\$174
	BRTSB30C	1 x 25 x 2	60	2.70	.02	\$173
	BRTSB24C	1 x 19 x 2	60	2.03	.01	\$169
	BRTSB15C	1 x 10 x 2	70	1.28	.01	\$134

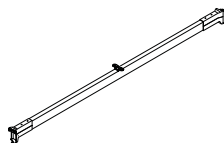
**Standard Table Beam**

Standard Table Beam bridges two legs to form support for a single table, or two back-to-back worksurfaces. Adjustable clamps at either end of the beam accommodate **standard table beam, end of run and interconnecting table beam applications**. Adjustable brackets ship attached to the beam. Specify Standard Table Beam size corresponding nominally to the worksurface length. Includes all hardware necessary to connect to legs. Powder coated steel beam and aluminum cast clamps.

Required Specifications

Metal Finish

BEAMS

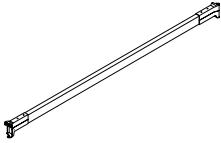

Bottom Table Beam

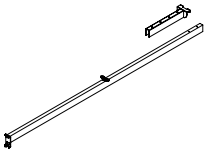

Telescopic Table Beam

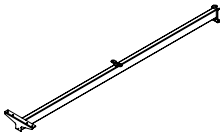

Storage Table Beam

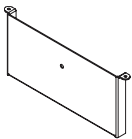

Storage Table Beam Adapter

MODEL#	DIMENSIONS D x W x H	FREIGHT CLASS	WT./LBS.	CUBIC FT.	LIST PRICE
BRTBB84C	1 x 79 x 2	60	10.32	.15	\$263
BRTBB78C	1 x 73 x 2	60	9.68	.12	\$256
BRTBB72C	1 x 67 x 2	60	9.04	.09	\$248
BRTBB66C	1 x 61 x 2	60	8.40	.09	\$239
BRTBB60C	1 x 55 x 2	60	7.75	.08	\$231
BRTBB54C	1 x 49 x 2	60	7.11	.07	\$222
BRTBB48C	1 x 43 x 2	60	6.74	.07	\$206
BRTBB42C	1 x 37 x 2	60	5.83	.06	\$198
BRTBB36C	1 x 31 x 2	60	5.19	.05	\$195

Bottom table beam connects to the lower cross beam on the 36" and 42" high "H" leg to create the footrest. One beam required for each table. Cannot be used as a substitute for the standard table beam. Specify bottom table beam that corresponds to the worksurface length. Includes all hardware necessary to connect to "H" leg. Powder coated steel beam and aluminum cast clamps.

BRTTB84C	1 x 96.5 x 2	60	10.32	.15	\$359
BRTTB78C	1 x 90.5 x 2	60	9.68	.12	\$352
BRTTB72C	1 x 84.5 x 2	60	9.04	.09	\$345
BRTTB66C	1 x 78.5 x 2	60	8.40	.09	\$337
BRTTB60C	1 x 72.5 x 2	60	7.75	.08	\$329
BRTTB54C	1 x 66.5 x 2	60	7.11	.07	\$316
BRTTB48C	1 x 60.5 x 2	60	6.74	.07	\$300
BRTTB42C	1 x 54.5 x 2	60	5.83	.06	\$287
BRTTB36C	1 x 48.5 x 2	60	5.19	.05	\$270

Provides support for a worksurface connected perpendicularly to a run of primary tables. Can be adjusted to accommodate 24" and 30" primary worksurfaces. One end of the beam is attached to a Leg Assembly while the other end is secured, off module to the perpendicular Standard Table Beam, End of Run or Interconnecting Beam. Specify Telescopic Table Beam size corresponding nominally to the return worksurface length.

BRTSTB84C	1 x 80.75 x 2	60	8.64	.09	\$257
BRTSTB78C	1 x 74.75 x 2	60	7.99	.08	\$251
BRTSTB72C	1 x 68.75 x 2	60	7.35	.08	\$242
BRTSTB66C	1 x 62.75 x 2	60	6.74	.07	\$234
BRTSTB60C	1 x 54.75 x 2	60	5.85	.06	\$221
BRTSTB54C	1 x 50.75 x 2	60	5.43	.05	\$205
BRTSTB48C	1 x 44.75 x 2	60	4.78	.05	\$195
BRTSTB42C	1 x 38.75 x 2	60	4.16	.04	\$192
BRTSTB36C	1 x 32.75 x 2	60	3.50	.03	\$184

Allows a worksurface to be supported by a leg on one side and storage tower(s) or spine of 21" and 25" interconnected storage units on the opposite side. Specify Storage Table Beam size corresponding nominally to the worksurface length. Includes all hardware necessary to connect the storage beam to the legs and worksurface.

BRTSA21	1 x 15.2 x 6.5	60	2.15	.05	\$87
BRTSA25	1 x 15.2 x 2.75	60	4.30	.02	\$74

Allows a worksurface to be supported by a leg on one side and storage spine on the opposite side. A typical storage spine is formed by series of Interconnected 21" or 25" storage cabinets of corresponding depth. The 21" or 25" adaptors provide structural support, acting as supports between the top of the storage cabinet spine and the bottom of the perpendicular worksurfaces. The flexible leg/beam/adaptor assembly arrangement allows the leg to be tucked in under the worksurface or to be shared by two adjacent worksurfaces. Specify Storage Beam nominally 18" shorter than worksurfaces for storage spine support application. Specify BRTSA21 or BRTSA25 depending on height of storage units forming the spine. Includes all hardware necessary to connect the adapter to the beam, worksurface and storage spine.

Required Specifications

Metal Finish

WORKSURFACES

MODEL# DIMENSIONS FREIGHT CLASS WT/LBS. CUBIC FT. LIST PRICE HP ADD

D x W x H

BRTWS2484	24 x 84 x 1	60	55	1.80	\$367	\$113
BRTWS2478	24 x 78 x 1	60	51	1.70	\$339	\$108
BRTWS2472	24 x 72 x 1	60	47	1.54	\$316	\$105
BRTWS2466	24 x 66 x 1	60	43	1.41	\$302	\$99
BRTWS2463	24 x 62.5 x 1	65	39	1.41	\$297	\$100
BRTWS2460	24 x 60 x 1	60	39	1.30	\$290	\$95
BRTWS2454	24 x 54 x 1	65	35	1.20	\$260	\$84
BRTWS2451	24 x 50.5 x 1	65	31	1.06	\$264	\$84
BRTWS2448	24 x 48 x 1	65	31	1.06	\$219	\$75
BRTWS2442	24 x 42 x 1	60	28	.90	\$184	\$61
BRTWS2436	24 x 36 x 1	60	23	.71	\$141	\$47

BRTWS3084	30 x 84 x 1	60	69	2.24	\$396	\$121
BRTWS3078	30 x 78 x 1	60	64	2.10	\$356	\$112
BRTWS3072	30 x 72 x 1	65	59	2	\$334	\$110
BRTWS3066	30 x 66 x 1	60	54	1.80	\$314	\$105
BRTWS3063	30 x 62.5 x 1	65	49	1.77	\$307	\$102
BRTWS3060	30 x 60 x 1	65	49	1.77	\$302	\$99
BRTWS3054	30 x 54 x 1	60	44	1.44	\$282	\$84
BRTWS3051	30 x 50.5 x 1	65	39	1.41	\$276	\$87
BRTWS3048	30 x 48 x 1	65	39	1.41	\$260	\$84
BRTWS3042	30 x 42 x 1	60	34	1.12	\$245	\$81
BRTWS3036	30 x 36 x 1	65	30	1.06	\$174	\$57

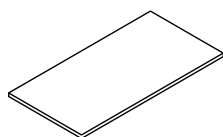

Rectangular Worksurface

Flat 3 mm edge profile on all sides.

BRTWSAA2484	24 x 84 x 1	60	51	1.70	\$437	\$212
BRTWSAA2478	24 x 78 x 1	60	47	1.54	\$415	\$189
BRTWSA2472	24 x 72 x 1	60	47	1.54	\$381	\$174
BRTWSA2466	24 x 66 x 1	60	43	1.41	\$353	\$151
BRTWSA2460	24 x 60 x 1	60	39	1.30	\$325	\$137
BRTWSA2454	24 x 54 x 1	65	35	1.20	\$288	\$130
BRTWSA2448	24 x 48 x 1	65	31	1.06	\$260	\$116
BRTWSA2442	24 x 42 x 1	60	28	.90	\$231	\$102

BRTWSAA3084	30 x 84 x 1	60	64	2.10	\$520	\$256
BRTWSAA3078	30 x 78 x 1	65	59	2	\$490	\$240
BRTWSA3072	30 x 72 x 1	65	59	2	\$454	\$209
BRTWSA3066	30 x 66 x 1	60	54	1.80	\$425	\$187
BRTWSA3060	30 x 60 x 1	65	49	1.77	\$381	\$174
BRTWSA3054	30 x 54 x 1	60	44	1.44	\$345	\$158
BRTWSA3048	30 x 48 x 1	65	39	1.41	\$309	\$137
BRTWSA3042	30 x 42 x 1	60	34	1.12	\$273	\$123

Flat 3 mm edge profile on all sides. Worksurfaces 42" to 72" w have one access door. 78" w and 84" w worksurfaces have two access doors. Access door is offset 13.5" from either side of worksurface. Anodized aluminum worksurface door provides access to power/data trough below worksurface. Worksurface with access doors CANNOT be combined with above worksurface power trough.

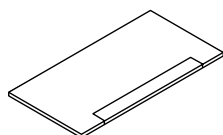

Rectangular Worksurface with Access Door

BRTWBE2451R	24 x 50.5 x 1	65	31	1.06	\$260	\$84
BRTWBE2463R	24 x 62.5 x 1	65	39	1.41	\$302	\$99
BRTWBE3051R	30 x 50.5 x 1	65	39	1.41	\$282	\$84
BRTWBE3063R	30 x 62.5 x 1	65	49	1.77	\$314	\$105

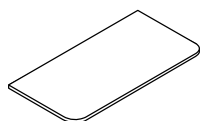

Rectangular Boardroom Table Top Extension, Round Corners

Flat 3 mm edge profile on all sides. Boardroom table extensions convert existing 24" or 30" deep back-to-back Bridges table assembly into a boardroom table. 24" and 30" d rectangular top with round corner can only be supported by 34" double leg and extension beams. *No freestanding and mobile application.*

Required Specifications

Top finish
Edge finish

Optional Specifications

HP laminate

WORKSURFACES

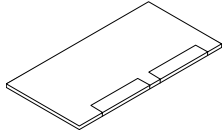

Rectangular Worksurface with 2 Access Doors

MODEL#	DIMENSIONS D x W x H	FREIGHT CLASS	WT/LBS.	CUBIC FT.	LIST PRICE	HP ADD
BRTWSAA2484	24 x 84 x 1	60	51	1.70	\$437	\$212
BRTWSAA2478	24 x 78 x 1	60	47	1.54	\$415	\$189
BRTWSAA2472	24 x 72 x 1	60	43	1.41	\$409	\$188
BRTWSAA2466	24 x 66 x 1	60	39	1.30	\$381	\$165
BRTWSAA2460	24 x 60 x 1	65	35	1.20	\$350	\$148
BRTWSAA3084	30 x 84 x 1	60	64	2.10	\$520	\$256
BRTWSAA3078	30 x 78 x 1	65	59	2	\$490	\$240
BRTWSAA3072	30 x 72 x 1	60	54	1.80	\$486	\$227
BRTWSAA3066	30 x 66 x 1	65	49	1.77	\$458	\$200
BRTWSAA3060	30 x 60 x 1	60	44	1.44	\$409	\$188

Flat 3 mm edge profile on all sides. Access doors are offset 10" (60" worksurfaces) and 13.5" (worksurfaces 66" and wider) from either side of work surface. Anodized aluminum work surface doors provide access to power/data trough below work surface. Worksurfaces with access doors CANNOT be combined with above work surface power troughs. Dimension between doors is 8" for 60" and 66" surfaces, 20" for 78", and 26" for 84".

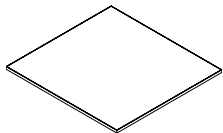

Meeting Table Top

BRTWS2451	24 x 50.5 x 1	65	31	1.06	\$264	\$84
BRTWS3051	30 x 50.5 x 1	65	39	1.41	\$276	\$87
BRTWS3651	36 x 50.5 x 1	65	43	1.71	\$409	\$67
BRTWS4251	42 x 50.5 x 1	65	48	1.93	\$454	\$121
BRTWS4851	48 x 50.5 x 1	65	52	2.07	\$515	\$133
BRTWS5151	50.5 x 50.5 x 1	65	55	2.12	\$551	\$127
BRTWS5451	54 x 50.5 x 1	65	59	2.19	\$596	\$165
BRTWS6051	60 x 50.5 x 1	65	63	2.26	\$677	\$170
BRTWS2463	24 x 62.5 x 1	65	39	1.41	\$297	\$100
BRTWS3063	30 x 62.5 x 1	65	49	1.77	\$307	\$102
BRTWS3663	36 x 62.5 x 1	65	53	1.94	\$460	\$118
BRTWS4263	42 x 62.5 x 1	65	57	2.07	\$551	\$143
BRTWS4863	48 x 62.5 x 1	65	61	2.13	\$662	\$166
BRTWS5463	54 x 62.5 x 1	65	63	2.21	\$745	\$186
BRTWS6063	60 x 62.5 x 1	65	67	2.34	\$829	\$204

Can create convenient, flexible extension of the back-to-back Bridges table assembly. Worksurfaces provided with pilot holes for alignment purposes.

- Meeting table top 50.5" long side matches 24" deep back-to-back Bridges table assembly
- Meeting table top 62.5" long side matches 30" deep back-to-back Bridges table assembly

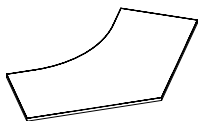

120° Worksurface

BRTWAC120424224	24 x 42 x 1	65	31	1.06	\$654	\$214
BRTWAC120424230	30 x 42 x 1	65	39	1.41	\$711	\$217

5-sided work surface can be used for a single, freestanding table, can form a pod of two or three tables, or can be combined with rectangular work surfaces to create a larger workstation.

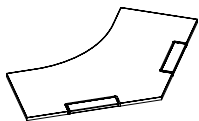

120° Worksurface with Access Door

BRTWAC120A424224	24 x 42 x 1	65	31	1.06	\$695	\$232
BRTWAC120A424230	30 x 42 x 1	65	39	1.41	\$751	\$291

5-sided work surface can be used for a single, freestanding table, can form a pod of two or three tables, or can be combined with rectangular work surfaces to create a larger workstation. Access door is offset 13.5" from either side of work surface. Anodized aluminum work surface door provides access to power/data trough below work surface. Work surface with access doors CANNOT be combined with above work surface power trough.

Required Specifications

Top finish
Edge finish

Optional Specifications

HP laminate

WORKSURFACES

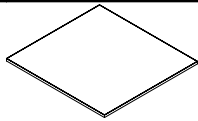

Rectangular Meeting Table Top*

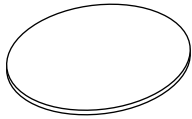

Round Meeting Table Top*

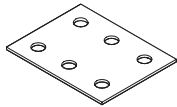

Flat Bracket

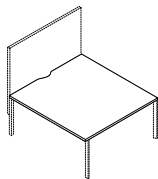

Display Wall Table Top w/Scoop*

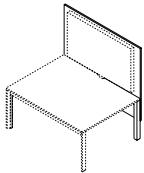

Monitor Facing Double Workstation**

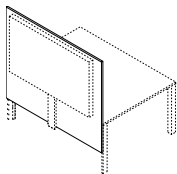

Monitor Facing Back of Double Workstation**

MODEL#	DIMENSIONS	FREIGHT CLASS	WT./LBS.	CUBIC FT.	LIST PRICE	HP ADD
--------	------------	---------------	----------	-----------	------------	--------

D x W x H

BRTMT5151	50.5 x 50.5 x 1	65	55	2.12	\$518	\$288
-----------	-----------------	----	----	------	--------------	--------------

50.5"long side matches 24"d back-to-back table assembly.

BRTMTR42	42 x 42 x 1	65	40	1.76	\$345	\$86
----------	-------------	----	----	------	--------------	-------------

BHBF01	4 x 3	70	.50	.01	\$15	
--------	-------	----	-----	-----	-------------	--

Constructed of cold rolled steel. May be used to ensure alignment of neighboring worksurfaces.

BRTWS6051SCP	60 x 50.5 x 1	60	75	1.75	\$663	\$167
BRTWS5451SCP	54 x 50.5 x 1	60	68	1.58	\$585	\$162
BRTWS4863SCP	48 x 62.5 x 1	60	75	1.74	\$649	\$163

BRTWS6063SCP	60 x 62.5 x 1	60	93	2.17	\$812	\$200
BRTWS5463SCP	54 x 62.5 x 1	60	84	1.95	\$731	\$182
BRTWS4863SCP	48 x 62.5 x 1	60	75	1.74	\$649	\$163

Display wall mounts to the end of back-to-back table assembly supported by rectangular legs. As opposed to two separate back-to-back worksurfaces, the display wall table top provides one continuous, uninterrupted surface with a scoop cutout next to the display wall (the scoop facilitates cable passage from below the table). Table top 50.5" w side matches 24" d back-to-back table assemblies. Meeting table tops 62.5" w side matches 30" d back-to-back table assemblies.

BRTTVFT63	4 x 62.5 x 52	100	74	7.52	\$1297	
BRTTVFT51	4 x 50.5 x 52	92.5	62	6.08	\$1227	

Display wall faces the double workstation; facilitates seated presentation area. Includes laminate board, TV/display brackets (black), mounting hardware, vertical cable manager (black). Slim (22mm) bracket capable of supporting displays/TVs up to 50" (resp. 62") wide, up to 80lbs. When installed, top of the 52" x 50.5" (resp. 62.5") wide board reaches 65.5"h. 1" LP laminate board with 3mm edging. Specify **WHB** to add HP white, dry-erase marker board laminate on non-display board surface and standard HP laminate on the opposite side. Display wall mounts to the end of back-to-back table assembly supported by rectangular legs or back-to-back table structure with BRTWSxxxxSCP Display Wall Table Top with Scoop.

- Included vertical cable manager passes through the gap between 2 back-to-back worksurfaces. Should you need one continuous, uninterrupted surface specify BRTWSxxxxSCP Display Wall Table Top with Scoop.
- Add **\$841** for white, dry erase on 51" w model, and **\$1123** for 63" w

BRTTVBK63	4 x 62.5 x 52	100	74	7.52	\$1297	
BRTTVBK51	4 x 50.5 x 52	92.5	62	6.08	\$1227	

Display wall support board mounts to end of back-to-back table assembly supported by rectangular legs. Display faces back of the double workstation (combine with collaborative seating). Includes laminate board, TV/display brackets (black), mounting hardware, vertical cable manager (black). Slim (22mm) bracket capable of supporting displays/TVs up to 50" (resp. 62") wide, up to 80lbs. When installed, top of the 52" x 50.5" (resp. 62.5") wide board reaches 65.5"h. 1" LP laminate board with 3mm edging. Specify **WHB** to add HP white, dry-erase marker board laminate on non-display board surface and standard HP laminate on the opposite side. Display wall mounts to the end of back-to-back table assembly supported by rectangular legs or back-to-back table structure with BRTWSxxxxSCP Display Wall Table Top with Scoop.

- Add **\$841** for white, dry erase on 51" w model, and **\$1123** for 63" w

Required Specifications

Top finish
Edge finish

Optional Specifications

HP laminate*
WHB**

POWER DELIVERY / CABLE MANAGEMENT

D x W x H

At the basic level, table and floor based office equipment is serviced by a wall or floor power supply. As the operation grows, there might be a need to organize excessive cable clutter.

Wire Basket (1) connects to the underside of worksurfaces with sprig brackets, and cables are simply dropped and coiled into them. *Wire Basket is not to be used with power troughs.*

Cable Snake (2) Installed in proximity of floor monument to manage vertical cable clutter..

Table clamped, single circuit **Desk Top Power Data Modules (3)** deliver services to desk height, while tapping into wall or floor power supply. Again, the excessive cables can be managed with Cable Trays.

Ceiling pole **BRTCPP (4)** manages power and data cables between ceiling and above or below worksurface power troughs.

Above and Below Worksurface Power/Data Troughs (5) can be installed between back-to-back tables for extended below and above desk height power/data distribution. 8 wire, 4-circuit system. (2 + 2 circuit configuration)

NOTE: Specify **BRTHH58 (8)** to distribute power from double-sided, back-to-back below worksurface power trough to a single-sided, below worksurface power trough at the end of a table run.

Leg shroud (9) attaches to 34" w legs and manages power floor feed, as well as data cables from floor monument.

Single Sided Power/Data Troughs (6) can be installed to the underside of a single table.

Storage power/data box BRTVCM (7) attaches to storage units and provides access to one duplex/data terminal on top storage surface. Integrated single circuit module can be plugged to floor monument under the storage or to a wall outlet

4-2-2 Wiring Schematic 8-Wire Shared Neutral "2 + 2" - 2 Utility Circuits, 2 Dedicated

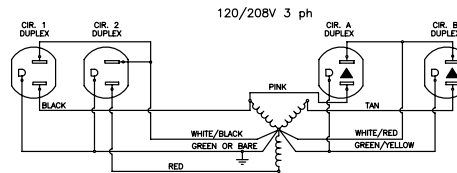
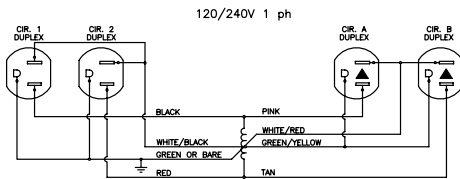

8 Wires

4 Lines (12 ga.)
2 Neutrals (10 ga.)
2 Grounds (12 ga.)

4 Circuits

2 Utility circuits
2 Dedicated Circuits

Receptacles

Duplex - Up to 12 duplex receptacles per circuit
(Up to 48 per infeed)

Specifications

System rated for connection to a grounded 120/240 V single phase, 20A, 60Hz or 120/208 V, 3 phase, 20A, 60Hz branch circuit for U.S. and 15A if product is marked with a C-UL Mark. Outlets rated 15A max.

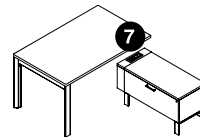
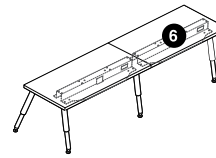
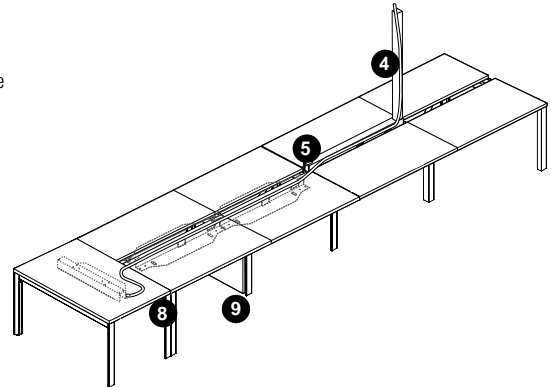
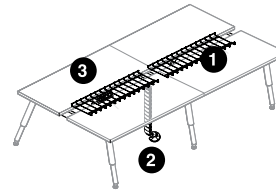

POWER DELIVERY / CABLE MANAGEMENT

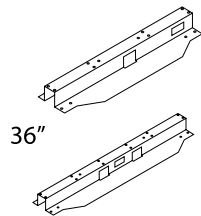

42" - 72"

Below Worksurface Single Power/Data Trough

MODEL# DIMENSIONS FREIGHT CLASS WT/LBS. CUBIC FT. LIST PRICE

D x W x H

MODEL#	DIMENSIONS D x W x H	FREIGHT CLASS	WT/LBS.	CUBIC FT.	LIST PRICE
BRTEETB84SKIT	11.6 x 78.34 x 2.5	100	12	1.31	\$833
BRTEETB78SKIT	11.6 x 72.34 x 2.5	100	11	1.21	\$797
BRTEETB72SKIT	11.6 x 66.34 x 2.5	100	9.80	1.11	\$518
BRTEETB66SKIT	11.6 x 60.34 x 2.5	100	8.90	1.01	\$502
BRTEETB60SKIT	11.6 x 54.34 x 2.5	100	8	.91	\$483
BRTEETB54SKIT	11.6 x 48.34 x 2.5	100	7.10	.81	\$473
BRTEETB48SKIT	11.6 x 42.34 x 2.5	100	6.20	.71	\$454
BRTEETB42SKIT	11.6 x 36.34 x 2.5	100	5.30	.61	\$418
BRTEETB36SKIT	11.6 x 30.34 x 2.5	125	4.50	.59	\$381

Formed steel trough is secured below a single table worksurface; outlets are facing the rear worksurface edge. Cannot be used on back-to-back tables. Specify Duplex receptacles separately. *Covers for duplex openings are not supplied.* 36" trough can house one duplex and 42-72" trough can house two duplexes. Specify jumpers between tables separately. Base feed entry at either end and not suitable for ceiling feed. Each trough provides one opening at 1.37" x 2.68" for terminal plate (not supplied). One terminal plate can accommodate up to 4 data/communication terminals (jacks). Data/comm plate spacer BRTPDS available to accommodate larger cable-to-terminal bending radius.

- BRTEETB36SKIT through BRTEETB72SKIT consist of one single sided steel trough, Power Distribution housing, mounting brackets and one charcoal grey extruded Data/Communication cable manager.
- BRTEETB78SKIT and BRTEETB84SKIT consist of two single-sided steel troughs, two Power Distribution Housings, mounting brackets and two charcoal grey extruded Data/Communication cable managers.
- BRTEETB78SKIT includes (1) BRTEETB36SKIT, (1) BRTEETB42SKIT and (1) JUMPER
- BRTEETB84SKIT includes (2) BRTEETB42SKIT and (1) JUMPER
- For 120° table applications, please specify BRTEETB36SKIT single trough kit for tables with BRTWAC120xx and BRTWAC120Axx worksurfaces. BRTEHH28 may be used as usual.
- Specify duplex receptacles separately
- Each trough includes one black BRTPDS Data/Comm spacer, extending the depth behind the Data/Comm opening by 0.6". White (BRTPDSW) and Silver (BRTPDSS). Data/Comm spacers are available as a special order for **\$42** list, see BRTPDS.

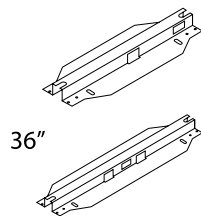

42" - 72"

Below Worksurface Double Power/Data Trough

BRTEETB84DKIT	8.5 x 78.3 x 2.5	92.5	9.80	.96	\$1076
BRTEETB78DKIT	8.5 x 72.3 x 2.5	92.5	9	.88	\$1061
BRTEETB72DKIT	8.5 x 66.3 x 2.5	92.5	8.30	.81	\$625
BRTEETB66DKIT	8.5 x 60.3 x 2.5	92.5	7.50	.74	\$611
BRTEETB60DKIT	8.5 x 54.3 x 2.5	92.5	6.80	.66	\$589
BRTEETB54DKIT	8.5 x 48.3 x 2.5	92.5	6	.59	\$574
BRTEETB48DKIT	8.5 x 42.3 x 2.5	92.5	5.30	.52	\$560
BRTEETB42DKIT	8.5 x 36.3 x 2.5	92.5	4.50	.44	\$538
BRTEETB36DKIT	8.5 x 30.3 x 2.5	92.5	3.80	.37	\$525

Formed steel trough is secured below worksurface; outlets between back-to-back stations supported by double table legs. Cannot be used on single table assemblies. Specify Duplex receptacles separately. *Covers for duplex openings are not supplied.* 36" trough can house one duplex per side and 42-72" trough can house two duplexes per side. Specify jumpers between tables separately. Ceiling feed entry through slots at either end; base feed entry at either end. Each trough provides one opening at 1.37" x 2.68" (one per side) for data/communication terminal plates. A single terminal plate (not supplied) can accommodate up to 4 data/communication plates. Data/comm plate spacer BRTPDS available to accommodate larger cable-to-terminal bending radius.

- BRTEETB36DKIT through BRTEETB72DKIT consist of one double-sided steel trough, Power Distribution housing, mounting brackets and one charcoal grey extruded Data/Communication cable manager.
- BRTEETB78DKIT and BRTEETB84DKIT consist of two double-sided steel troughs, two Power Distribution Housings, mounting brackets and two charcoal grey extruded Data/Communication cable managers.
- BRTEETB78DKIT includes (1) BRTEETB36DKIT, (1) BRTEETB42DKIT and (1) JUMPER
- BRTEETB84SKIT includes (2) BRTEETD42SKIT and (1) JUMPER
- Each trough includes one black BRTPDS Data/Comm spacer, extending the depth behind the Data/Comm opening by 0.6". White (BRTPDSW) and Silver (BRTPDSS). Data/Comm spacers are available as a special order for **\$42** list, see BRTPDS.

Required Specifications

Metal Finish (Power/Data Troughs)

ELECTRICAL COMPONENTS

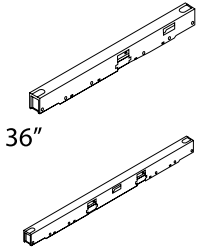

42" - 72"

Above Worksurface Power Trough

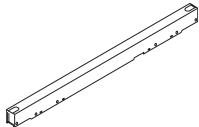

Back-to-Back Storage Tower Gap Filler Kit

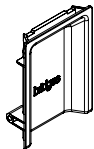

Above Worksurface Power Trough

MODEL#	DIMENSIONS D x W x H	FREIGHT CLASS	WT/LBS.	CUBIC FT.	LIST PRICE
BRTEETA84KIT	2.5 x 84 x 3.5	65	9.49	.42	\$933
BRTEETA78KIT	2.5 x 78 x 3.5	65	8.81	.39	\$898
BRTEETA72KIT	2.5 x 71.9 x 3.5	65	8.12	.36	\$589
BRTEETA66KIT	2.5 x 65.9 x 3.5	65	7.45	.33	\$582
BRTEETA60KIT	2.5 x 59.9 x 3.5	65	6.77	.30	\$538
BRTEETA54KIT	2.5 x 53.9 x 3.5	65	6.09	.27	\$525
BRTEETA48KIT	2.5 x 47.9 x 3.5	65	5.41	.24	\$496
BRTEETA42KIT	2.5 x 41.9 x 3.5	65	4.73	.21	\$467
BRTEETA36KIT	2.5 x 35.9 x 3.5	65	4.06	.18	\$431

Formed steel trough is secured between back-to-back stations. Cannot be used on single table assemblies. Specify Duplex receptacles separately. *Covers for duplex openings are not supplied.* 36" trough side. Specify jumpers between tables separately. Ceiling feed entry through can house one duplex per side and 42-72" trough can house two duplexes per slots at either end; base feed entry at either end. Each trough provides two openings at 1.37" x 2.68" (one per side) for data/communication terminal plates. A single terminal plate (not supplied) can accommodate up to 4 data/comm plates. Data/comm plate spacer BRTPDS available to accommodate larger cable-to-terminal bending radius.

- BRTEETA36KIT through BRTEETA72KIT consist of one double-sided steel trough, Power Distribution Housing, mounting brackets and one charcoal grey extruded Data/Communication cable manager.
- BRTEETA78KIT and BRTEETA84KIT consist of two double-sided steel troughs, two Power Distribution Housings, mounting brackets and two charcoal grey extruded Data/Communication cable managers.
- BRTEETA78KIT includes (1) BRTEETA36KIT, (1) BRTEETA42KIT and (1) JUMPER
- BRTEETA84KIT includes (2) BRTEETA42KIT and (1) JUMPER
- Specify above worksurface power trough end cap BRTEETEC to finish open ends of the power trough
- Each trough includes one black BRTPDS Data/Comm spacer, extending the depth behind the Data/Comm opening by 0.6". White (BRTPDSW) and Silver (BRTPDSS). Data/Comm spacers are available as a special order for **\$42** list, see BRTPDS.

BRTEST15KIT	15.5 x 2.5 x 3.5	65	2	.08	\$388
BRTEST24KIT	24 x 2.5 x 3.5	70	2.50	.12	\$421
BRTEST30KIT	31 x 2.5 x 3.5	70	3.50	.16	\$449
BRTEST48KIT	48 x 2.5 x 3.5	70	4	.24	\$495

Consists of a formed sheet metal cover and four brackets which allow the cover to be mounted at either above worksurface power trough level or below worksurface power trough level. Versatile brackets secure the cover trough at corners, to the bottom of back-to-back worksurface supported by either shared 51" or 63" legs or storage beam and storage towers.

- Note: the back-to-back storage tower gap filler is not compatible with single, freestanding tables.
- The BRTEST15kit and BRTEST24kit cover the gap between two back-to-back BRTT5024x or BRTT5030x storage towers
- The BRTEST30kit and BRTEST48kit cover the gap between two pairs of back-to-back BRTT5024x or BRTT5030x storage towers

BRTEETEC	.5 x 2.25 x 3	70	.10	.01	\$7
----------	---------------	----	-----	-----	------------

Covers the end of the worksurface power trough. Specify two per linear trough assembly. White finish only.

Required Specifications

Metal Finish (Power/Data Troughs)

ELECTRICAL COMPONENTS

MODEL# DIMENSIONS FREIGHT CLASS WT./LBS. CUBIC FT. LIST PRICE

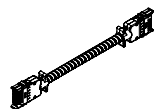

Housing to Housing Harness

	D x W x H				
BRTEHH28	.5 x 28 x 2	70	1	1.17	\$130
BRTEHH40	.5 x 40.5 x 2	70	1.10	1.25	\$140
BRTEHH44	.5 x 44.5 x 2	70	1.5	1.17	\$151
BRTEHH52	.5 x 52.5 x 2	300	2.0	1.17	\$159
BRTEHH58	.5 x 58.5 x 2	300	2.2	1.17	\$165
BRTEHH76	.5 x 76.5 x 2	250	2.8	1.17	\$185

Distributes power between Power Distribution Housings.

- BRTEHH28 distributes power between back-to-back troughs in a straight run.
- BRTEHH40 distributes power from back-to-back and single sided power troughs
- BRTEHH44 distributes power between back-to-back power troughs separated by (1) pair of storage cabinets without wardrobes. Specify BRTEST15KIT separately.
- BRTEHH52 distributes power from back-to-back power troughs separated by (1) pair of storage cabinets without wardrobes. Specify BRTEST24KIT separately.
- BRTEHH58 distributes power from back-to-back power troughs separated by (2) pairs of storage cabinets without wardrobes. Specify BRTEST30KIT separately.
- BRTEHH58 also distributes power from double-sided, back-to-back below worksurface power troughs to a single sided, below worksurface power trough at the end of a table run.
- BRTEHH76 distributes power from back-to-back power troughs separated by (2) pairs of storage cabinets without wardrobes. Specify BRTEST48KIT separately.

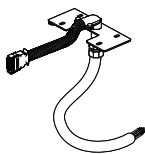

Base Feed

BRTEBF	6 x 4 x 72	250	4	2	\$399
BRTEBF120	6 x 4 x 120	250	6	2	\$557
BRTEBF144	6 x 4 x 144	150	8	2	\$599

Provides single power entry from floor or wall located building power supply. Connects to Power Distribution Housing. Must be hard wired to the building power supply by a licensed electrician.

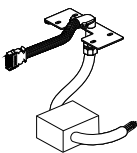

Base Feed - New York Electrical

BRTEBFK	6 x 4 x 100	250	4	2	\$627
---------	-------------	-----	---	---	--------------

Provides single power entry from floor or wall located building power supply. Connects to Power Distribution Housing. Must be hard wired to the building power supply by a licensed electrician.



Ceiling Pole

BRTCPP	1.5 x 4.75 x 99	65	13	.48	\$216
--------	-----------------	----	----	-----	--------------

Brings ceiling feed conduit and data cables from the ceiling down to Power Troughs at desk height. Accommodates 10' ceiling heights. Two part construction allows power/data conduit lay-in. Attaches to a junction between two adjacent Power Troughs in back-to-back applications only. Not for use on single sided Bridges II troughs. Includes mounting hardware and ceiling bezel. Painted Finish.

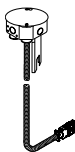

Ceiling Feed

BRTECF120	6 x 6 x 120	250	5	2	\$350
BRTECF144	6 x 6 x 144	250	5	2	\$389

Provides single power entry from ceiling, through ceiling pole into Power Trough, into Power Distribution Module. An 8 wire (4 circuit) metal conduit harness with included metal junction box for hard wiring to the building power supply above ceiling tile. Must be hard wired to the building power supply by a licensed electrician. Ceiling Pole not included.

Required Specifications

Metal Finish (BRTCPP)

ELECTRICAL COMPONENTS

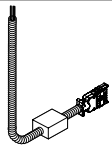

Ceiling Feed - New York Electrical

MODEL#	DIMENSIONS D x W x H	FREIGHT CLASS	WT./LBS.	CUBIC FT.	LIST PRICE
BRTECFK120	6 x 6 x 120	250	5	2	\$525
BRTECFK144	6 x 6 x 144	250	5	2	\$582

Provides single power entry from ceiling, through ceiling pole into Power Trough, into Power Distribution Module. An 8 wire (4 circuit) metal conduit harness with included metal junction box for hard wiring to the building power supply above ceiling tile. Must be hard wired to the building power supply by a licensed electrician. Ceiling Pole not included.

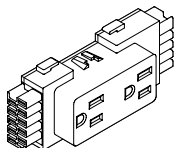

Duplex Receptacles

BRTE8D1	1.25 x 4.63 x 2	70	.10	.01	\$29
BRTE8D2	1.25 x 4.63 x 2	70	.10	.01	\$29
BRTE8DA	1.25 x 4.63 x 2	70	.10	.01	\$29
BRTE8DB	1.25 x 4.63 x 2	70	.10	.01	\$29
BRTE8DXW1	1.25 x 4.63 x 2	70	.10	.01	\$42
BRTE8DXW2	1.25 x 4.63 x 2	70	.10	.01	\$42
BRTE8DXWA	1.25 x 4.63 x 2	70	.10	.01	\$42
BRTE8DXWB	1.25 x 4.63 x 2	70	.10	.01	\$42

Snaps into Power Distribution Housing. Up to 13 duplex receptacles per circuit XW identifies white color plastic, all others standard in black.

- BRTE8D1 / BRTE8DXW1 - Circuit #1 (utility circuit)
- BRTE8D2 / BRTE8DXW2 - Circuit #2 (utility circuit)
- BRTE8DA / BRTE8DXWA - Circuit A (dedicated circuit)
- BRTE8DB / BRTE8DXWB - Circuit B (dedicated circuit)



Power/Data Cable Basket

BRTCB76KIT	8 x 34 x 1	70	1.56	.15	\$193
BRTCB70	8 x 70 x 1	100	3.22	.34	\$140
BRTCB64	8 x 64 x 1	92.5	2.94	.29	\$129
BRTCB58	8 x 58 x 1	92.5	2.66	.26	\$126
BRTCB52	8 x 52 x 1	100	2.39	.24	\$118
BRTCB46	8 x 46 x 1	92.5	2.16	.21	\$112
BRTCB40	8 x 40 x 1	70	1.80	.18	\$105
BRTCB34	8 x 34 x 1	70	1.56	.15	\$101
BRTCB28	8 x 28 x 1	70	1.20	.13	\$89
BRTCB22	8 x 22 x 1	70	1.01	.10	\$84
BRTCB16	8 x 16 x 1	70	.73	.07	\$78
BRTCB8	8 x 8 x 1	70	.36	.03	\$71

Shallow, 8" wide basket manages cable excess and serves to manage cords and cables. It can be easily unclipped from spring steel brackets (included) to rearrange cable connections from below worksurface. Spring steel brackets can suspend the Cable Basket below storage cabinet's bottom where it keeps the cords and cables off the floor and manages them under storage cabinets along the horizontal plane - between floor monuments and Storage Vertical Cable Manager, for example. Tall storage cabinet's legs provide easy access to the Cable Basket where it can easily be unclipped from spring steel brackets to rearrange cable connections. Steel wire construction, chrome finish baskets; black spring steel hanging brackets, fasteners.

- Wide Cable Baskets can span under several storage cabinets. Specify Cable Basket a min. 8" shorter than the storage cabinet spine assembly.

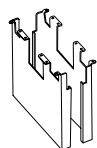

34" Leg Shroud

BRTDLSHS34	5 x 30 x 29	92.5	62	5.25	\$398
------------	-------------	------	----	------	--------------

A two part steel enclosure creates 5" deep and 30" wide cable management cavity between 34" rectangular table legs. Hides floor power feeds as well as data/communication cables rising from floor monuments to the underside of Bridges II tables. Secures to BRTBA34L rectangular leg and to underside of worksurfaces. Specify powder coat finish.

Required Specifications
Metal Finish (BRTDLSHS34)

ELECTRICAL COMPONENTS

**Cable Snake**

MODEL#	DIMENSIONS D x W x H	FREIGHT CLASS	WT/LBS.	CUBIC FT.	LIST PRICE
--------	-------------------------	---------------	---------	-----------	------------

BRTCS	2 x 8 x 30	70	3	.19	\$111
-------	------------	----	---	-----	--------------

Flexible cable management trough. Two pathways within the snake, one for data/communication and one for routing power cables. Translucent White finish only.

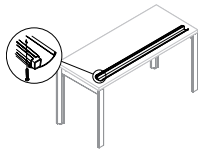
**Wire Manager**

BRTCM43	46 x 5 x 3	92.5	8	.67	\$44
BRTCM55	58 x 5 x 3	92.5	9	.85	\$52

Replacement wire manager can be added. Wire Manager neatly organizes and stores electrical and communication cables. Two lengths: 46" for tops 60" and under; 58" for tops 72". Black Plastic only.

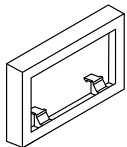
**Data/Comm Spacer**

BRTPDS	.6 x 4.75 x 2.04	70	.10	.01	\$42
BRTPDSW	.6 x 4.75 x 2.04	70	.10	.01	\$42
BRTPDSS	.6 x 4.75 x 2.04	70	.10	.01	\$42

Data/Comm plate spacer extends the depth behind data/comm jacks by 0.6" in order to accommodate larger data/comm cable bending radius. BRTPDS is Black, BRTPDSW is White and BRTPDSS is Silver.

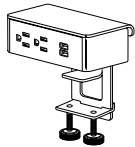
**Duo Module**

BRED50	3.2 x 5.5 x 1.8	70	2.50	.14	\$298
--------	-----------------	----	------	-----	--------------

The duo power module is completely integrated with a mounting clamp to attach to the edge of a worksurface. Provides two outlets and two 2.1 amp USB ports. White face plate, outlets and bracket; 72" long three-prong black cord, silver body.

**Duo Under Module**

BREDU51	2.8 x 5.5 x 1.8	70	2.50	.14	\$258
---------	-----------------	----	------	-----	--------------

The duo under power module comes with a thin flush mounting bracket to attach to the underside of a worksurface or above worksurface shelves. Provides two outlets and two 2.1 amp USB ports. White face plate, outlets and brackets; 72" long three-prong black cord, silver body.

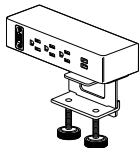
**Trio Plus Module**

BRETP53	3.2 x 8 x 1.8	70	2.50	.14	\$337
---------	---------------	----	------	-----	--------------

The trio plus power module is completely integrated with a mounting clamp to attach to the edge of a worksurface or above worksurface shelves. Provides three outlets and two 2.1 amp USB ports and an adapter kit containing blank cover, HDMI, RJ45 or VGA adapter brackets. Note: HDMI, RJ45 and VGA connectors are not included. White face plate, outlets, adapters and brackets; 72" long three-prong black cord.

ELECTRICAL COMPONENTS

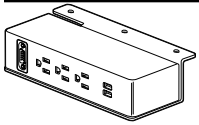

Trio Plus Under Module

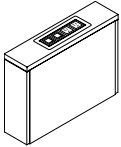

Vertical Cable Manager*

MODEL#	DIMENSIONS	FREIGHT CLASS	WT./LBS.	CUBIC FT.	LIST PRICE
--------	------------	---------------	----------	-----------	------------

	D x W x H				
BRETPU54	2.8 x 8 x 1.8	70	2.50	.14	\$313

The trio plus under power module comes with a thin flush mounting bracket to attach to the underside of a worksurface. Provides three outlets and two 2.1 amp USB ports and an adapter kit containing blank cover, HDMI, RJ45 or VGA adapter brackets. Note: HDMI, RJ45 and VGA connectors are not included. White face plate, outlets, adapters and brackets; 72" long three-prong black cord.

BRTVCM2118	18 x 6 x 21	92.5	14	1.31	\$788
BRTVCM2518	18 x 6 x 25	92.5	17	1.56	\$804
BRTVCM2124	24 x 6 x 21	100	17	1.75	\$833
BRTVCM2524	24 x 6 x 25	92.5	22	2.08	\$846

Facilitates power/data transfer from a floor monument under storage cabinets. The units can join other 18" or 24" deep storage units to form a storage spine. Removable top with a Below worksurface Power/Data Module provides easy access. Optional cable basket suspends off storage unit's bottom and manages cables along the horizontal plane. 1" top, unfinished cut-out edges. Universal connecting hardware included. Below Worksurface Power/Data Module included. Provides power - two outlets; 72"L 3-prong power cord. White face plate, outlets and coupler & jack adapters; anodized aluminum bracket supports; thumb screws, black cord. Provides data - two coupler/jack ports; includes Voice/Data Adapter Kit to accept various couplers & jacks (Not Included).

Required Specifications

- Top finish*
- Edge finish*
- Chassis finish*

ACCESSORIES / TABLE DIVIDERS MODEL# DIMENSIONS FREIGHT CLASS WT./LBS. CUBIC FT. LIST PRICE

- 9mm thick panels offered in 9 finishes
- Made from 100% PET (polyester) fiber with a high content (50%) of post-recycled material, free of added chemicals, binders and adhesives
- Lightweight panels are tackable, impact and tear resistant, bacteria resistant, moisture resistant, and installation friendly
- Variation in fiber mix and color are inherent to the character of the product

BRACKET/EXTRUSION FINISH

BLK	Black
CHR	Charcoal
DWT	Designer White
NEV	Nevada
SIL	Silver
TPE	Taupe
TUN	Tungsten
TU2	Tungsten 2
ANO	Anodized Aluminum - Upcharge applies. <i>Refer to models for upcharge.</i>

FELT COLORS

BLK	Black	MTS	Mist
BRI	Brick	PWT	Pewter
DEN	Denim	SHR	Shamrock
GPH	Graphite	WHT	White
HVT	Harvest		

FELT DIVIDERS MODEL# DIMENSIONS FREIGHT CLASS WT./LBS. CUBIC FT. LIST PRICE

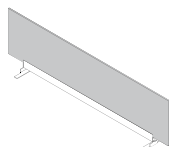

Back-to-Back Parallel Felt Divider

BRTAFDD84	7.5 x 81 x 16.88	125	6.30	1	\$523
BRTAFDD78	7.5 x 75 x 16.88	125	5.90	.92	\$499
BRTAFDD72	7.5 x 69 x 16.88	125	5.40	.85	\$474
BRTAFDD66	7.5 x 63 x 16.88	125	5	.77	\$450
BRTAFDD60	7.5 x 57 x 16.88	125	4.60	.70	\$425
BRTAFDD54	7.5 x 51 x 16.88	125	4.10	.63	\$401
BRTAFDD48	7.5 x 45 x 16.88	125	3.70	.55	\$283
BRTAFDD42	7.5 x 39 x 16.88	125	3.20	.48	\$250
BRTAFDD36	7.5 x 33 x 16.88	125	2.80	.41	\$224

Secures between two back-to-back tables; provides privacy, divides space. 9mm felt material is tackable. Installed divider measures 15.7" from the top of the worksurface. Available in 9 PET felt colors. Please specify. Brackets and extrusion available in all standard Bridges II paint finishes. 36"- 72" wide dividers include 2 support brackets. 78" and 84" wide dividers include 3.

- Anodized Aluminum extrusion - Add **\$120** list upcharge

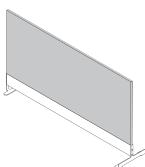

Perpendicular Side to Side Off Module Felt Divider

BRTAFPPD30M	6.5 x 30.24 x 16.85	100	2.60	.27	\$212
BRTAFPPD24M	6.5 x 24.24 x 16.85	100	2.10	.22	\$187

Secures off module to front and back edges of a table; provides privacy, divides space. 9mm felt material is tackable. 24M and 30M kits are designed to be installed on tables with **recessed** legs (round legs, 34" rectangular legs). Cannot be installed at the end of a run. Installed divider measures 15.7" from the top of the worksurface. Available in 9 PET felt colors. Please specify. Brackets and extrusion available in all standard Bridges II paint finishes.

- Anodized Aluminum extrusion - Add **\$120** list upcharge

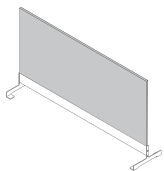

Perpendicular Side to Side Felt Divider

BRTAFPPD63S	6.5 x 62.81 x 16.85	100	4.20	.46	\$442
BRTAFPPD51S	6.5 x 50.81 x 16.85	100	4.20	.46	\$394
BRTAFPPD30S	6.5 x 30.24 x 16.85	92.5	2.70	.27	\$218
BRTAFPPD24S	6.5 x 24.24 x 16.85	92.5	2.30	.22	\$193

Secures to the front edge of both worksurfaces, regardless of type of leg support - supporting brackets can straddle over shared leg; provides privacy, divides space. 9mm felt material is tackable. Cannot be installed at the end of a run. Installed divider measures 15.7" from the top of the worksurface. Available in 9 PET felt colors. Please specify. Brackets and extrusion available in all standard Bridges II paint finishes.

- Anodized Aluminum extrusion - Add **\$120** list upcharge

Required Specifications	Optional Specifications
Felt color	Anodized extrusion
Bracket/extrusion finish	

FELT DIVIDERS

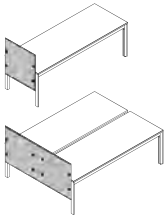

End of Run Felt Divider*

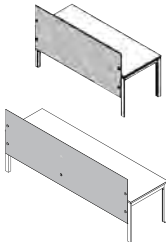

Parallel Felt Divider*



Modesty Felt Divider

MODEL#	DIMENSIONS D x W x H	FREIGHT CLASS	WT/LBS.	CUBIC FT.	LIST PRICE
BRTAFED63	4.82 x 62.56 x 30.68	250	7.60	2.44	\$1087
BRTAFED51	4.82 x 50.56 x 30.68	250	6.80	1.97	\$1000
BRTAFED30	4.82 x 31.4 x 30.68	250	3.70	1.22	\$536
BRTAFED24	4.82 x 25.4 x 30.68	250	3.40	.99	\$510

Secures to the side edge of a single or double back-to-back table; provides privacy, divides space. 9mm felt material is tackable. Installed divider measures 15.7" from the top of the worksurface and 15" below the worksurface. 24" and 30" dividers include 2 brackets. 51" and 63" dividers include 4 brackets. Available in 9 PET felt colors. Please specify. Brackets and extrusion available in all standard Bridges II paint finishes.

- Anodized Aluminum extrusion - Add **\$120** list upcharge

BRTAFDS84	4.82 x 81 x 30.68	250	7.50	3.16	\$1129
BRTAFDS78	4.82 x 75 x 30.68	250	7.20	2.92	\$1111
BRTAFDS72	4.82 x 69 x 30.68	250	6.90	2.69	\$1094
BRTAFDS66	4.82 x 63 x 30.68	250	6.70	2.46	\$946
BRTAFDS60	4.82 x 57 x 30.68	250	5.10	2.22	\$761
BRTAFDS54	4.82 x 51 x 30.68	250	4.80	1.92	\$718
BRTAFDS48	4.82 x 45 x 30.68	250	4.50	1.75	\$650
BRTAFDS42	4.82 x 39 x 30.68	250	4.20	1.52	\$633
BRTAFDS36	4.82 x 33 x 30.68	250	3.80	1.29	\$616

Secures to the rear edge of a single table; provides privacy, divides space. 9mm felt material is tackable. Installed divider measures 15.7" from the top of the worksurface and 15" below the worksurface. 36" to 60" dividers include 2 brackets. 66" to 84" dividers include 3 brackets. Available in 9 PET felt colors. Please specify. Brackets and extrusion available in all standard Bridges II paint finishes.

- Anodized Aluminum extrusion - Add **\$120** list upcharge
- 66" - 84" dividers require 3 support brackets and cannot be used with worksurfaces that have a single access door.

BRTAFMPS84	3.62 x 77.75 x 13.42	250	3.50	1.21	\$685
BRTAFMPS78	3.62 x 71.75 x 13.42	250	3.40	1.12	\$673
BRTAFMPS72	3.62 x 65.75 x 13.42	250	3.30	1.02	\$661
BRTAFMPS66	3.62 x 59.75 x 13.42	250	3.10	.93	\$649
BRTAFMPS60	3.62 x 53.75 x 13.42	250	2.40	.84	\$492
BRTAFMPS54	3.62 x 47.75 x 13.42	250	2.30	.74	\$411
BRTAFMPS48	3.62 x 41.75 x 13.42	250	2.10	.65	\$398
BRTAFMPS42	3.62 x 35.75 x 13.42	250	2	.56	\$386
BRTAFMPS36	3.62 x 29.75 x 13.42	70	1.70	.46	\$372

Secures to the rear edge of a single table; provides privacy, divides space. 9mm felt material is tackable. Installed divider measures 15" below the worksurface. 36" to 60" dividers include 2 brackets. 66" to 84" dividers include 3 brackets. Available in 9 PET felt colors. Please specify. Brackets and extrusion available in all standard Bridges II paint finishes.

- 66" - 84" dividers require 3 support brackets and cannot be used with worksurfaces that have a single access door.

Required Specifications

Felt color
Bracket/extrusion finish

Optional Specifications

Anodized extrusion*

TABLE DIVIDERS

MODEL# DIMENSIONS FREIGHT CLASS WT./LBS. CUBIC FT. LIST PRICE

D x W x H

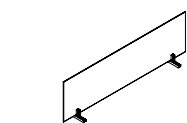

36" - 72"

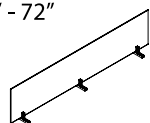

78" - 84"

Table Divider - Glass

BRTAGDD84	.25 x 81 x 16	60	29	.18	\$640
BRTAGDD78	.25 x 75 x 16	60	27	.17	\$603
BRTAGDD72	.25 x 69 x 16	60	25	.16	\$518
BRTAGDD66	.25 x 63 x 16	60	23	.14	\$483
BRTAGDD60	.25 x 57 x 16	60	21	.13	\$445
BRTAGDD54	.25 x 51 x 16	60	18	.11	\$425
BRTAGDD48	.25 x 45 x 16	60	16	.10	\$389
BRTAGDD42	.25 x 39 x 16	60	14	.09	\$360
BRTAGDD36	.25 x 33 x 16	60	12	.07	\$325

Secures between two back-to-back tables; provides privacy, divides space. Installed divider measures 15.7" from the top of the worksurface. 36" - 72" wide dividers include 2 support brackets. 78" and 84" wide dividers include 3. Frosted tempered glass. Satin chrome lower bracket, upper is available in all standard Bridges II paint finishes.

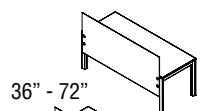

36" - 72"

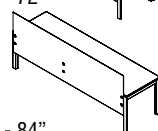

78" - 84"

Parallel Table Divider - Glass

BRTAGDS84	.25 x 81 x 32	60	55	.35	\$1221
BRTAGDS78	.25 x 75 x 32	60	51	.33	\$1162
BRTAGDS72	.25 x 69 x 32	60	47	.30	\$972
BRTAGDS66	.25 x 63 x 32	60	43	.28	\$913
BRTAGDS60	.25 x 57 x 32	60	39	.25	\$854
BRTAGDS54	.25 x 51 x 32	60	35	.23	\$797
BRTAGDS48	.25 x 45 x 32	60	31	.20	\$738
BRTAGDS42	.25 x 39 x 32	60	27	.18	\$679
BRTAGDS36	.25 x 33 x 32	60	23	.15	\$622

Secures to the rear edge of a single table; provides privacy, divides space while not obstructing available light. 36" - 72" wide dividers include 2 support brackets. 78" and 84" wide dividers include 3. Frosted tempered glass. Satin chrome lower bracket, upper is available in all standard Bridges II paint finishes.

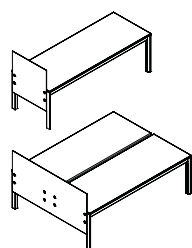

Perpendicular End of Run Divider - Glass

BRTAGED63	.25 x 62.5 x 32	60	35	.23	\$1280
BRTAGED51	.25 x 50.5 x 32	60	31	.20	\$1162
BRTAGED30	.25 x 30 x 32	60	27	.18	\$650
BRTAGED24	.25 x 24 x 32	60	23	.15	\$593

Secures to the rear edge of a single or double back-to-back table; provides privacy, divides space while not obstructing available light. Installed divider reaches 15.7" from the top of the worksurface and 15" below the worksurface. Rounded front top corner of 24" and 30" deep glass dividers. 51" and 63" glass dividers for back-to-back tables have both top corners rounded. 24" and 30" wide dividers include 2 support brackets; 51" and 63" wide dividers include 3. Frosted tempered glass. Satin chrome lower bracket, upper is available in all standard Bridges II paint finishes.

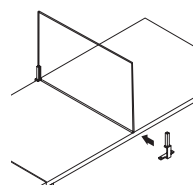

Shared Perpendicular Side to Side Divider, Middle - Glass, Rounded Corners

BRTAGPPD24M	.25 x 24 x 16	60	9	.06	\$372
BRTAGPPD30M	.25 x 30 x 16	60	11.25	.07	\$390

Provides privacy, divides space while not obstructing available light. 24M and 30M kits are designed to be installed on tables with **recessed** legs (round legs, 34" rectangular legs). 24" and 30" kits consist of a wide rear bracket, narrow front bracket (white powder coated steel), tempered glass with **rounded** top corners (acid etched on one side), bracket-fitting gaskets and mounting screws securing the brackets to the underside of the worksurface. Satin chrome lower bracket, upper is available in all standard Bridges II paint finishes.

Required Specifications

Bracket finish

TABLE DIVIDERS

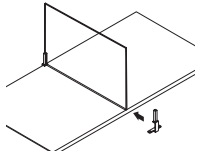

Shared Perpendicular Side to Side Divider, Middle - Glass, Square Corners

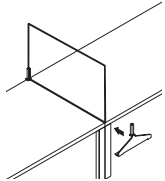

Shared Perpendicular Side to Side Divider, Seam - Glass, Rounded Corners

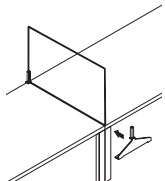

Shared Perpendicular Side to Side Divider, Seam - Glass, Square Corners

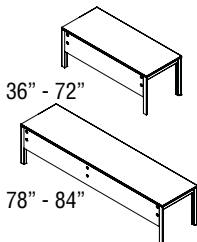

Modesty Panel - Glass

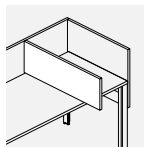

Perpendicular Laminate Side to Side Divider - Extended*

MODEL#	DIMENSIONS D x W x H	FREIGHT CLASS	WT./LBS.	CUBIC FT.	LIST PRICE
BRTAGPPD24MQ	.25 x 24 x 16	60	9	.06	\$372
BRTAGPPD30MQ	.25 x 30 x 16	60	11.25	.07	\$390

Provides privacy, divides space while not obstructing available light. 24M and 30M kits are designed to be installed on tables with **recessed** legs (round legs, 34" rectangular legs). 24" and 30" kits consist of a wide rear bracket, narrow front bracket (white powder coated steel), tempered glass with **square** top corners (acid etched on one side), bracket-fitting gaskets and mounting screws securing the brackets to the underside of the worksurface. Brackets are available in all standard Bridges II paint finishes.

BRTAGPPD24S	.25 x 24 x 16	60	9	.05	\$372
BRTAGPPD30S	.25 x 30 x 16	60	11.25	.07	\$390

Provides privacy, divides space while not obstructing available light. 24S and 30S kits are designed to be installed in the middle or over a seam of two adjacent worksurfaces supported by a shared, full depth **rectangular** leg. 24S and 30S kits consist of two wide rear brackets, wide front bracket, tempered glass with **rounded** top corners (acid etched on one side), bracket-fitting gaskets and mounting screws securing the brackets to the underside of the worksurface. Brackets are available in all standard Bridges II paint finishes.

BRTAGPPD24SQ	.25 x 24 x 16	60	9	.05	\$372
BRTAGPPD30SQ	.25 x 30 x 16	60	11.25	.07	\$390

Provides privacy, divides space while not obstructing available light. 24S and 30S kits are designed to be installed in the middle or over a seam of two adjacent worksurfaces supported by a shared, full depth **rectangular** leg. 24S and 30S kits consist of two wide rear brackets, wide front bracket, tempered glass with **square** top corners (acid etched on one side), bracket-fitting gaskets and mounting screws securing the brackets to the underside of the worksurface. Brackets are available in all standard Bridges II paint finishes.

BRTAGMPS84	.25 x 77.75 x 13.25	60	24	.14	\$797
BRTAGMPS78	.25 x 71.75 x 13.25	60	22	.13	\$768
BRTAGMPS72	.25 x 65.75 x 13.25	60	20	.12	\$607
BRTAGMPS66	.25 x 59.75 x 13.25	60	19	.11	\$578
BRTAGMPS60	.25 x 53.75 x 13.25	60	17	.10	\$548
BRTAGMPS54	.25 x 47.75 x 13.25	60	15	.09	\$520
BRTAGMPS48	.25 x 41.75 x 13.25	60	11	.06	\$491
BRTAGMPS42	.25 x 35.75 x 13.25	60	11	.06	\$460
BRTAGMPS36	.25 x 29.75 x 13.25	60	9	.05	\$432

Secures to the rear edge of a single table, between table legs; provides privacy. Installed divider reaches 15" below the worksurface. 36" - 72" wide modesty panels include 2 mounting brackets. 78" and 84" wide modesty panels include 3 mounting brackets. Tempered glass, acid etched on one side (similar to frosted), and satin chrome disc fasteners. Brackets are available in all standard Bridges II paint finishes.

BRTLPE36	.75 x 36 x 16	60	11	.25	\$220
BRTLPE30	.75 x 30 x 16	60	9	.21	\$192

Protrudes by 6" beyond the front worksurface edge for added privacy. Secures off-module or on-module to the front and back edge of worksurface, regardless of type of leg support - supporting brackets can straddle over shared leg. 3/4" LP PVC edge boards. Brackets are available in all standard Bridges II paint finishes.

- Specify BRTLPE30 for 24" d worksurfaces and BRTLPE36 for 30" d worksurfaces

Required Specifications

Chassis/Accent Finish (Laminate Dividers)
Bracket finish
Edge finish*

TABLE DIVIDERS

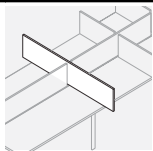

Perpendicular Laminate Side to Side Double Divider - Extended

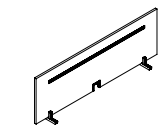

36" - 72"

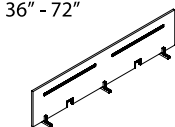

78" - 84"

Table Divider - Laminate

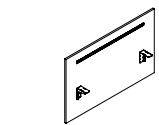

36" - 72"

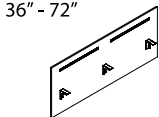

78" - 84"

High Table Divider - Laminate

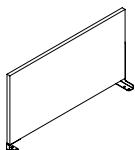

High Perpendicular Side-to-Side Divider - Laminate

MODEL#	DIMENSIONS	FREIGHT CLASS	WT/LBS.	CUBIC FT.	LIST PRICE
--------	------------	---------------	---------	-----------	------------

D x W x H					
-----------	--	--	--	--	--

BRTLDPSE75	.75 x 75 x 16	60	22	.52	\$397
BRTLDPSE63	.75 x 63 x 16	60	18	.44	\$356

Protrudes by 6" beyond the front worksurface edge for added privacy. Installs on-module, between two BRTLPPD dividers. It is secured to the front edge of both worksurfaces, regardless of type of leg support - supporting brackets can straddle over shared leg. Brackets are available in all standard Bridges II paint finishes. 3/4" LP PVC edge boards.

- Can ONLY be installed on-module between two BRTLPPD dividers.
- Specify BRTLDPSE63 for 24"d back-to-back worksurfaces and BRTLDPSE75 for 30"d back-to-back worksurfaces

BRTLPPD84	.75 x 81 x 16	60	24	.56	\$482
BRTLPPD78	.75 x 75 x 16	60	23	.52	\$465
BRTLPPD72	.75 x 69 x 16	60	21	.47	\$371
BRTLPPD66	.75 x 63 x 16	60	19	.43	\$347
BRTLPPD60	.75 x 57 x 16	60	17	.39	\$331
BRTLPPD54	.75 x 51 x 16	60	15	.35	\$316
BRTLPPD48	.75 x 45 x 16	60	14	.31	\$300
BRTLPPD42	.75 x 39 x 16	60	12	.27	\$278
BRTLPPD36	.75 x 33 x 16	60	10	.22	\$253

Secures between two back-to-back tables; provides privacy, divides space. Installed divider measures 15.7" from the top of the worksurface. 36" - 72" wide dividers include 2 support brackets and one pass-through grommet. 78" and 84" wide dividers include 3 support brackets and 2 pass-through grommets. 3/4" PVC edged boards. Integrated anodized aluminum accessory rail, white cut out and rail trims. Brackets are available in all standard Bridges II paint finishes.

- Please refer to the **Compatibility Guide** on page 406 to determine available accessories

BRTLPPDS84	.75 x 81 x 32	60	50	1.16	\$755
BRTLPPDS78	.75 x 75 x 32	60	47	1.08	\$724
BRTLPPDS72	.75 x 69 x 32	60	43	1	\$592
BRTLPPDS66	.75 x 63 x 32	60	40	.91	\$560
BRTLPPDS60	.75 x 57 x 32	60	36	.83	\$529
BRTLPPDS54	.75 x 51 x 32	60	32	.75	\$489
BRTLPPDS48	.75 x 45 x 32	60	29	.66	\$465
BRTLPPDS42	.75 x 39 x 32	60	25	.56	\$434
BRTLPPDS36	.75 x 33 x 32	60	22	.50	\$355

Installed on one side only. Secures to the back of a single table; provides privacy, divides space. Installed divider measures 15.7" from the top of the worksurface and 15" below the worksurface. 36" - 72" wide dividers include 2 support brackets. 78" and 84" wide dividers include 4 support brackets. 3/4" self edged boards. Integrated anodized aluminum accessory rail, white cut out and rail trims. Brackets are available in all standard Bridges II paint finishes. Integrated modesty panel.

- Please refer to the **Compatibility Guide** on page 406 to determine available accessories

BRTLPPD24	.75 x 24 x 16	60	7	.16	\$175
BRTLPPD30	.75 x 30 x 16	60	9	.20	\$190

Secures off-module to front and back edges of a table; provides privacy, divides space. Can be installed anywhere along worksurface or over the seam of two adjacent worksurfaces. Cannot be installed at the end of a run. Installed divider measures 15.7" from the top of the worksurface. 3/4" self edged boards. Brackets are available in all standard Bridges II paint finishes.

Required Specifications

Chassis/Accent finish
Bracket finish
Edge finish

TABLE DIVIDERS

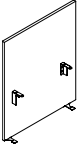

Perpendicular End of Run Divider, Laminate*

MODEL#	DIMENSIONS D x W x H	FREIGHT CLASS	WT/LBS.	CUBIC FT.	LIST PRICE
BRTLPE24	.75 x 24 x 32	60	7	.16	\$279
BRTLPE30	.75 x 30 x 32	60	9	.20	\$300
BRTLPE51	.75 x 50.5 x 32	60	15	.35	\$473
BRTLPE63	.75 x 62.5 x 32	60	19	.43	\$536

Secures to the side edge of a table; provides privacy, divides space. Installed divider measures 15.7" from the top of the worksurface and 15" below the worksurface. Integrated modesty panel. 3/4" self edged boards. Brackets are available in all standard Bridges II paint finishes. For Rectangular leg only.

- BRTLPE51 divider matches 24" deep back-to-back assemblies
- BRTLPE63 divider matches 30" deep back-to-back assemblies

TABLE DIVIDERS - FABRIC

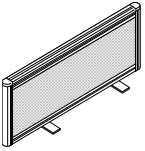

Table Divider - Fabric**

MODEL#	DIMENSIONS	YARDAGE	FREIGHT CLASS	WT/LBS.	CUBIC FT.	LIST PRICE
BR2AFD84	1.30 x 84 x 16	1	70	32	1.95	\$464
BR2AFD78	1.30 x 78 x 16	1	70	28	1.81	\$437
BR2AFD72	1.30 x 72 x 16	1	70	24	1.57	\$409
BR2AFD66	1.30 x 66 x 16	1	85	20	1.53	\$393
BR2AFD60	1.30 x 60 x 16	.50	92.5	15	1.39	\$393
BR2AFD54	1.30 x 54 x 16	.50	92.5	13	1.25	\$367
BR2AFD48	1.30 x 48 x 16	.50	85	11	.75	\$341
BR2AFD42	1.30 x 42 x 16	.50	100	9	.97	\$330
BR2AFD36	1.30 x 36 x 16	.50	100	8	.83	\$316

Attaches between Back-to-Back Tables for space division and privacy. Includes accessory rail along the top to hang accessories on both sides. Installed dividers measure 16" from the top of the worksurface. 36", 42" and 48" wide dividers include 2 brackets, all others include 3. To be used on corresponding table lengths. Extended third, central bracket can pass under worksurface access door. Dividers over 60" must have fabric railroaded. Brackets are available in all standard Bridges II paint finishes.

- Please refer to the **Compatibility Guide** on page 406 to determine available accessories

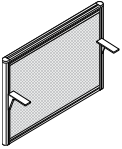

Table Divider - Fabric, Table Hung**

BR2AHD72	1.30 x 72 x 32	1	70	50	3	\$520
BR2AHD66	1.30 x 66 x 32	1	70	42	2.75	\$517
BR2AHD60	1.30 x 60 x 32	.60	85	36	2.50	\$526
BR2AHD54	1.30 x 54 x 32	.60	85	31	2.25	\$500
BR2AHD48	1.30 x 48 x 32	.50	85	28	2	\$478
BR2AHD42	1.30 x 42 x 32	.50	85	24	1.75	\$457
BR2AHD36	1.30 x 36 x 32	.40	85	19	1.50	\$429

Attaches to the rear edge of a table and serves as a privacy/modesty panel. Includes accessory rail along the top to hang accessories on both sides. Installed dividers measure 16" from the top of the worksurface and 15" below the worksurface. For round leg table assemblies only. To be used on corresponding table lengths. Dividers over 60" must have fabric railroaded. Brackets are available in all standard Bridges II paint finishes.

- Please refer to the **Compatibility Guide** on page 406 to determine available accessories

MODESTY PANEL

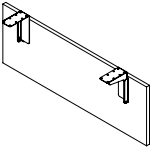

Laminate Modesty Panel*

MODEL#	DIMENSIONS	FREIGHT CLASS	WT/LBS.	CUBIC FT.	LIST PRICE
BRTMPS84	.75 x 78.5 x 14	60	22	.51	\$425
BRTMPS78	.75 x 72.5 x 14	60	20	.47	\$409
BRTMPS72	.75 x 66.5 x 14	60	19	.43	\$396
BRTMPS66	.75 x 60.5 x 14	60	17	.40	\$381
BRTMPS60	.75 x 54.5 x 14	60	16	.36	\$367
BRTMPS54	.75 x 48.5 x 14	60	14	.32	\$353
BRTMPS48	.75 x 42.5 x 14	60	13	.29	\$338
BRTMPS42	.75 x 36.5 x 14	60	11	.25	\$325
BRTMPS36	.75 x 30.5 x 14	60	9	.21	\$309

Secures to the back edge of a table; provides privacy, divides space. Installed divider measures 15" below the worksurface. 3/4" self edged boards. Flips down for easy access to underside of worksurface. Brackets are available in all standard Bridges II paint finishes.

Required Specifications

- Chassis/Accent finish*
- Edge finish*
- Panel fabric**
- Bracket finish

ACCESSORIES

MODEL# DIMENSIONS FREIGHT CLASS WT./LBS. CUBIC FT. LIST PRICE

D x W x H

BRTPEG24	.75 x 24 x 14	60	6	.14	\$181
BRTPEG24H21	.75 x 24 x 20.5	60	9	.21	\$210
BRTPEG24H27	.75 x 24 x 26.5	60	12	.26	\$245
BRTPEG30	.75 x 30 x 14	60	8	.18	\$195
BRTPEG30H21	.75 x 30 x 20.5	60	12	.26	\$223
BRTPEG30H27	.75 x 30 x 26.5	60	15	.33	\$259
BRTPEG51	.75 x 50.5 x 14	60	13	.30	\$316
BRTPEG51H21	.75 x 50.5 x 20.5	60	20	.43	\$384
BRTPEG51H27	.75 x 50.5 x 26.5	60	26	.56	\$445
BRTPEG63	.75 x 62.5 x 14	60	16	.38	\$345
BRTPEG63H21	.75 x 62.5 x 20.5	60	25	.53	\$411
BRTPEG63H27	.75 x 62.5 x 26.5	60	32	.69	\$473

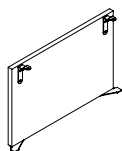

Laminate End of Run Gable*

Perpendicular end of a run gable. Secures to the side edge of a table/tables and legs; provides privacy, divides space. ¾" self edged boards. Brackets are available in all standard Bridges II paint finishes. **For Rectangular leg only.**

- BRTPEG24, 30, 51 and 63 measure 15" below worksurface
- BRTPEGxxH21 lines up with the bottom of storage cabinets
- BRTPEGxxH27 reaches down 1" from the floor (creates full panel look)

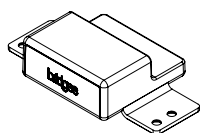
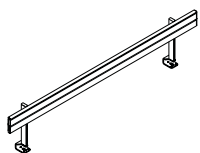

Table End Gap Filler

BRTTEGF	4.5 x 2.5 x 1	70	.03	.01	\$10
---------	---------------	----	-----	-----	-------------

Injection molded block fills the gap finishing the end of back-to-back table assemblies. Secures to the bottom of two back-to-back worksurfaces. Injection molded resin, white.



Single Table Accessory Rail

BRLBST84	2.95 x 81 x 13.5	70	10.24	.61	\$403
BRLBST78	2.95 x 75 x 13.5	70	9.69	.56	\$391
BRLBST72	2.95 x 69 x 13.5	70	9.15	.52	\$380
BRLBST66	2.95 x 63 x 13.5	70	8.61	.48	\$367
BRLBST60	2.95 x 57 x 13.5	70	8.07	.43	\$355
BRLBST54	2.95 x 51 x 13.5	70	7.52	.39	\$347
BRLBST48	2.95 x 45 x 13.5	70	6.98	.35	\$334
BRLBST42	2.95 x 39 x 13.5	70	6.44	.30	\$323
BRLBST36	2.95 x 33 x 13.5	65	5.90	.26	\$307

Table mounted accessory rail. Compatible with standard accessories. Includes end caps and mounting hardware.

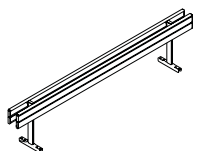

Back-To-Back Accessory Rail

BRLBB2B84	7.50 x 81 x 13.5	65	17.69	.74	\$666
BRLBB2B78	7.50 x 75 x 13.5	65	16.61	.69	\$642
BRLBB2B72	7.50 x 69 x 13.5	65	15.52	.63	\$618
BRLBB2B66	7.50 x 63 x 13.5	65	14.44	.58	\$595
BRLBB2B60	7.50 x 57 x 13.5	65	13.36	.53	\$571
BRLBB2B54	7.50 x 51 x 13.5	65	12.27	.48	\$554
BRLBB2B48	7.50 x 45 x 13.5	65	11.19	.42	\$529
BRLBB2B42	7.50 x 39 x 13.5	65	10.10	.37	\$505
BRLBB2B36	7.50 x 33 x 13.5	65	9.02	.32	\$475

Table mounted accessory rail. Compatible with standard accessories. Includes end caps and mounting hardware.

Required Specifications

Chassis/Accent finish*

Edge finish*

Bracket finish*

FRAMED DIVIDERS

D x W x H

Single Table Or Single Table Row Application; 16" and 30" high dividers

Table Mounted Framed Divider for single table or single table row; recessed 1.5" at both ends, mounted to the table with 0.6" gap at the back.
 BRTMFD/BRTMLD 36" (33" actual) - 66" (63" actual) dividers have 2 mounting brackets.
 BRTMFD/BRTMLD 72" (69" actual) - 84" (81" actual) dividers have 3 mounting brackets.

Perpendicular Single Table End of Run Framed Divider;
 BREFD/BRELD 24" (21" actual for 24" deep worksurfaces),
 BREFD/BRELD 30" (27" actual for 30" deep worksurfaces),
 BREFD/BRELD 36" (33" actual for 36" deep worksurfaces),

Two brackets secure the divider to the side edge of work surface. Flush with rear edge, 3" recessed from front work surface edge.

Perpendicular Shared Framed Divider;
 BRSEFD/BRSLD 24" (21" actual for 24" deep worksurfaces),
 BRSEFD/BRSLD 30" (27" actual for 30" deep worksurfaces),
 BRSEFD/BRSLD 36" (33" actual for 36" deep worksurfaces),

Single bracket secures the divider to the rear edge of worksurface; Can be mounted off-module or over the seam of two adjacent worksurfaces. Flush with the rear edge, 3" recessed from front worksurface edge.

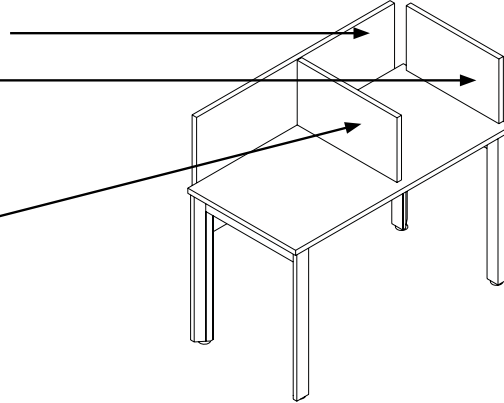

Back-To-Back Table Application; 16" dividers

Perpendicular Back 2 Back Parallel Framed Divider secured between two back-to-back tables; recessed 1.5" at both ends; 0.6" gap between the divider and work surfaces.
 BRPFD/BRPLD 36" (33" actual) - 66" (63" actual) dividers have 2 mounting brackets.
 BRPFD/BRPLD 72" (69" actual) - 84" (81" actual) dividers have 3 mounting brackets.

Perpendicular Shared Frame Back 2 Back Framed Divider;
 BRSEFD/BRSDLD 51" (45" actual for 24" deep back-to-back work surfaces)
 BRSEFD/BRSDLD 63" (57" actual for 30" deep back-to-back work surfaces).
 One bracket secures the divider through the gap between work surfaces; two brackets locate top of the divider between two adjacent Parallel dividers.
 NOTE: cannot be used on its own without the two Parallel dividers.
 3" recessed from front worksurface edges.

Perpendicular Back-To-Back End of Run Framed Divider;
 BREDFD/BRELDL 51" (45" actual for 24" deep back-to-back worksurfaces)
 BREDFD/BRELDL 63" (57" actual for 30" deep back-to-back worksurfaces).
 Three brackets secure the divider to both side edges of worksurfaces.
 3" recessed from front worksurface edges.

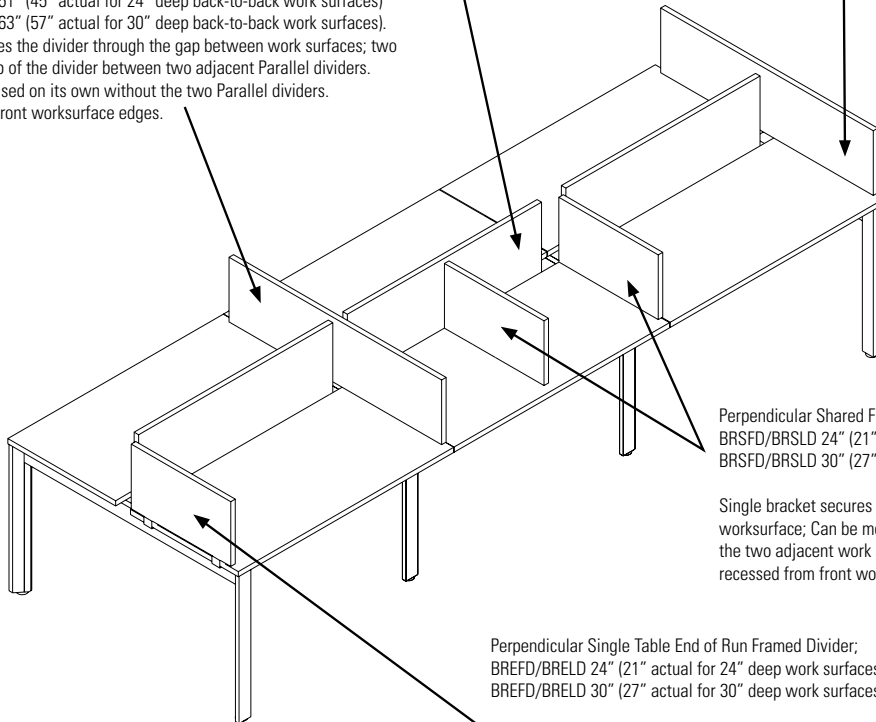

Perpendicular Shared Framed Divider;
 BRSEFD/BRSLD 24" (21" actual for 24" deep work surfaces).
 BRSEFD/BRSLD 30" (27" actual for 30" deep work surfaces).

Single bracket secures the divider to the rear edge of worksurface; Can be mounted off-module or over the seam of the two adjacent work surfaces. Flush with the rear edge, 3" recessed from front work surfaces edge.

Perpendicular Single Table End of Run Framed Divider;
 BREFD/BRELD 24" (21" actual for 24" deep work surfaces).
 BREFD/BRELD 30" (27" actual for 30" deep work surfaces).

Two brackets secure the divider to the side edge of work surface. Flush with the rear edge, 3" recessed from front work surface edge.

Required Specifications

Top finish
 Edge finish
 Metal finish (legs)

Optional Specifications

Anodized Aluminum Leg
 HP laminate

FRAMED DIVIDERS

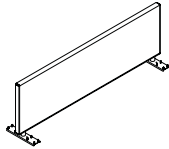

**Back-to-Back Parallel Framed Divider
Fabric**

MODEL#	DIMENSIONS D x W x H	FREIGHT CLASS	WT/LBS.	CUBIC FT.	LIST PRICE
BRPFD84	1.25 x 81 x 16	70	32	1.95	\$669
BRPFD78	1.25 x 75 x 16	70	28	1.81	\$635
BRPFD72	1.25 x 69 x 16	70	24	1.57	\$626
BRPFD66	1.25 x 63 x 16	85	20	1.53	\$602
BRPFD60	1.25 x 57 x 16	92.5	15	1.39	\$568
BRPFD54	1.25 x 51 x 16	92.5	13	1.25	\$478
BRPFD48	1.25 x 45 x 16	85	11	.75	\$454
BRPFD42	1.25 x 39 x 16	100	9	.97	\$393
BRPFD36	1.25 x 33 x 16	100	8	.83	\$384

Secures to the underside of the worksurface. Fabric divider is tackable and always railroaded. Installed divider measures 15.7" from top of worksurface. 36" to 54" dividers include 2 support brackets. 60" to 84" dividers include 3 support brackets. Brackets are available in all standard Bridges II paint finishes.

- 60" - 84" dividers require 3 support brackets and cannot be used with worksurfaces that have a single access door

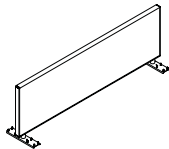

Back-to-Back Parallel Framed Divider

MODEL#	DIMENSIONS D x W x H	FREIGHT CLASS	WT/LBS.	CUBIC FT.	LIST PRICE	HP ADD	DE ADD	DM ADD
BRPLD84	1.25 x 81 x 16	70	32	2.25	\$470	\$236	\$537	\$1370
BRPLD78	1.25 x 75 x 16	70	28	2.08	\$461	\$213	\$538	\$1364
BRPLD72	1.25 x 69 x 16	70	24	1.92	\$455	\$190	\$537	\$1355
BRPLD66	1.25 x 63 x 16	85	20	1.75	\$440	\$199	\$495	\$1355
BRPLD60	1.25 x 57 x 16	92.5	15	1.58	\$425	\$163	\$502	\$1266
BRPLD54	1.25 x 51 x 16	92.5	13	1.42	\$355	\$143	\$524	\$1287
BRPLD48	1.25 x 45 x 16	85	11	1.25	\$304	\$109	\$234	\$617
BRPLD42	1.25 x 39 x 16	100	9	1.08	\$270	\$86	\$199	\$531
BRPLD36	1.25 x 33 x 16	100	8	.92	\$256	\$79	\$178	\$468

Secures to the underside of the worksurface. Divider infill can be specified in low pressure laminate (**LP**), high pressure laminate (**HP**), dry erase whiteboard (**DE**) or dry erase magnetic whiteboard (**DM**). Installed divider measures 15.7" from top of worksurface. 36" to 54" dividers include 2 support brackets. 60" to 84" dividers include 3 support brackets. Brackets are available in all standard Bridges II paint finishes.

- 60" - 84" dividers require 3 support brackets and cannot be used with worksurfaces that have a single access door

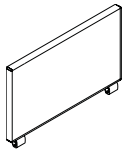

**Perpendicular Single Table End of Run
Framed Divider, Fabric**

MODEL#	DIMENSIONS D x W x H	FREIGHT CLASS	WT/LBS.	CUBIC FT.	LIST PRICE
BREFD36	1.25 x 33 x 16	85	12	.92	\$339
BREFD30	1.25 x 27 x 16	85	11	.75	\$306
BREFD24	1.25 x 21 x 16	70	9	.58	\$297

Connects to the perpendicular end of a single or back-to-back table. Fabric divider is tackable and always railroaded. Installed divider measures 15.7" from top of worksurface. Divider comes with 2 support brackets. Two brackets secure the divider to the side edge of worksurface. Flush with the rear edge, 3" recessed from front worksurface edge. Brackets are available in all standard Bridges II paint finishes.

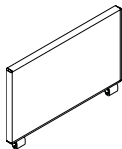

**Perpendicular Single Table End of Run
Framed Divider, Laminate**

MODEL#	DIMENSIONS D x W x H	FREIGHT CLASS	WT/LBS.	CUBIC FT.	LIST PRICE	HP ADD	DE ADD	DM ADD
BRELD36	1.25 x 33 x 16	70	20	.92	\$220	\$80	\$178	\$278
BRELD30	1.25 x 27 x 16	65	17	.75	\$214	\$71	\$135	\$213
BRELD24	1.25 x 21 x 16	65	14	.58	\$191	\$57	\$122	\$186

Connects to the perpendicular end of a single or back-to-back table. Divider infill can be specified in low pressure laminate (**LP**), high pressure laminate (**HP**), dry erase whiteboard (**DE**) or dry erase magnetic whiteboard (**DM**). Installed divider measures 15.7" from top of worksurface. Divider comes with 2 support brackets. Two brackets secure the divider to the side edge of worksurface. Flush with the rear edge, 3" recessed from front worksurface edge. When dry erase magnetic whiteboard (**DM**) is specified it is applied user side **ONLY** and dry erase whiteboard (**DE**) is applied on the opposite side. Brackets are available in all standard Bridges II paint finishes.

Required Specifications

Fabric
Finish
Bracket finish

SHARED FRAMED DIVIDERS

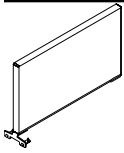

Perpendicular Shared Framed Divider, Fabric

MODEL#	DIMENSIONS D x W x H	FREIGHT CLASS	WT/LBS.	CUBIC FT.	LIST PRICE
BRSFD36	1.25 x 33 x 16	85	12	.92	\$330
BRSFD30	1.25 x 27 x 16	85	11	.75	\$297
BRSFD24	1.25 x 21 x 16	70	9	.58	\$288

Connects anywhere along and between worksurfaces to divide space and create privacy. Divider is fastened under the worksurface flush to the back of the table and recessed 3" from the front edge on the user side. Fabric divider is tackable and always railroaded. Installed divider measures 15.7" from top of worksurface. Divider comes with a support bracket at the back and a spacer plate with double sided adhesive at the front. Brackets are available in all standard Bridges II paint finishes.

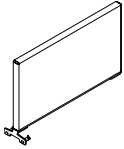

Perpendicular Shared Framed Divider, Laminate

					LIST PRICE	HP ADD	DE ADD	DM ADD
BRSLD36	1.25 x 33 x 16	70	20	.92	\$220	\$80	\$178	\$461
BRSLD30	1.25 x 27 x 16	65	17	.75	\$206	\$71	\$135	\$410
BRSLD24	1.25 x 21 x 16	65	14	.58	\$191	\$52	\$114	\$306

Connects anywhere along and between worksurfaces to divide space and create privacy. Divider is fastened under the worksurface flush to the back of the table and recessed 3" from the front edge on the user side. Divider infill can be specified in low pressure laminate (LP), high pressure laminate (HP), dry erase whiteboard (DE) or dry erase magnetic whiteboard (DM). Installed divider measures 15.7" from top of worksurface. Divider comes with a support bracket at the back and a spacer plate with double sided adhesive at the front. Brackets are available in all standard Bridges II paint finishes.

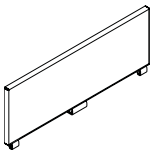

Perpendicular Back-to-Back End of Run Framed Divider, Fabric

					LIST PRICE
BREDFD63	1.25 x 57 x 16	85	21	1.58	\$524
BREDFD51	1.25 x 45 x 16	85	18	1.25	\$462

Connects to the end of run on a back-to-back tables to create privacy. Divider is fastened under the worksurface and recessed 3" from the user edge on either side. Fabric divider is tackable and always railroaded. Installed divider measures 15.7" from top of worksurface. Divider comes with 1 large and 2 small support brackets. Brackets are available in all standard Bridges II paint finishes.

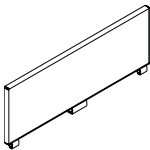

Perpendicular Back-to-Back End of Run Framed Divider, Laminate

					LIST PRICE	HP ADD	DE ADD	DM ADD
BREDLD63	1.25 x 57 x 16	70	32	1.58	\$384	\$163	\$510	\$758
BREDLD51	1.25 x 45 x 16	70	26	1.25	\$312	\$107	\$243	\$361

Connects to the end of run on a back-to-back tables to create privacy. Divider is fastened under the worksurface and recessed 3" from the user edge on either side. Divider infill can be specified in low pressure laminate (LP), high pressure laminate (HP), dry erase whiteboard (DE) or dry erase magnetic whiteboard (DM). Installed divider measures 15.7" from top of worksurface. Divider comes with 1 large and 2 small support brackets. When dry erase magnetic whiteboard (DM) is specified it is applied user side ONLY and dry erase whiteboard (DE) is applied on the opposite side. Brackets are available in all standard Bridges II paint finishes.

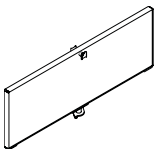

Perpendicular Back-to-Back Shared Framed Divider, Fabric

					LIST PRICE
BRSDFD63	1.25 x 57 x 16	85	20	1.58	\$497
BRSDFD51	1.25 x 45 x 16	85	17	1.25	\$435

Connects between parallel framed dividers for back-to-back tables to divide space and create privacy. Divider is fastened under the worksurface and recessed 3" from the user edge on either side. Fabric divider is tackable and always railroaded. Installed divider measures 15.7" from top of worksurface. Divider comes with 1 center support bracket, 2 spacer plates with adhesive and 2 top spacer clamps. Brackets are available in all standard Bridges II paint finishes.

- Cannot be used on its own without the two parallel dividers

Required Specifications

Fabric
Finish
Bracket finish

SHARED FRAMED DIVIDERS

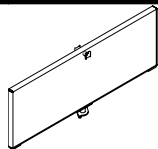

Perpendicular Back-to-Back Shared Framed Divider, Laminate*

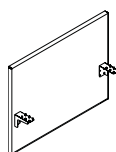

Table Mounted Framed Divider, Fabric*

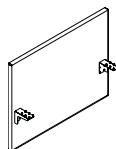

Table Mounted Framed Divider, Laminate*



Ceiling Pole for Wellness Screens

MODEL#	DIMENSIONS D x W x H	FREIGHT CLASS	WT/LBS.	CUBIC FT.	LIST PRICE			
					LIST PRICE	HP ADD	DE ADD	DM ADD
BRSDLD63	1.25 x 57 x 16	70	32	1.58	\$368	\$157	\$502	\$1266
BRSDLD51	1.25 x 45 x 16	70	26	1.25	\$298	\$107	\$233	\$615

Connects between parallel framed dividers for back-to-back tables to divide space and create privacy. Divider is fastened under the worksurface and recessed 3" from the user edge on either side. Divider infill can be specified in low pressure laminate (**LP**), high pressure laminate (**HP**), dry erase whiteboard (**DE**) or dry erase magnetic whiteboard (**DM**). Installed divider measures 15.7" from top of worksurface. Divider comes with 1 center support bracket, 2 spacer plates with adhesive and 2 top spacer clamps. Brackets are available in all standard Bridges II paint finishes.

- Cannot be used on its own without the two parallel dividers

					LIST PRICE			
BRTMFD84	1.25 x 81 x 30	70	43	4.22	\$759			
BRTMFD78	1.25 x 75 x 30	70	40	3.91	\$706			
BRTMFD72	1.25 x 69 x 30	70	37	3.59	\$679			
BRTMFD66	1.25 x 63 x 30	85	33	3.28	\$656			
BRTMFD60	1.25 x 57 x 30	92.5	30	2.97	\$577			
BRTMFD54	1.25 x 51 x 30	92.5	27	2.66	\$514			
BRTMFD48	1.25 x 45 x 30	85	25	2.34	\$462			
BRTMFD42	1.25 x 39 x 30	100	22	2.03	\$410			
BRTMFD36	1.25 x 33 x 30	100	20	1.90	\$348			

Parallel divider for single tables. Fabric divider is tackable and always railroaded. Fastens to the underside of the worksurface. 0.6" gap between worksurface and divider allows for cable pass thru. Installed divider reaches 15.7" up and 15" down from top of worksurface. 36" to 66" dividers include 2 support brackets. 72" to 84" dividers include 3 support brackets. Brackets are available in all standard Bridges II paint finishes.

- 72" - 84" dividers require 3 support brackets and cannot be used with worksurfaces that have a single access door

					LIST PRICE	HP ADD	DE ADD	DM ADD
BRTMLD84	1.25 x 81 x 30	70	83	4.22	\$961	\$314	\$1318	\$2114
BRTMLD78	1.25 x 75 x 30	70	77	3.91	\$946	\$315	\$1318	\$2114
BRTMLD72	1.25 x 69 x 30	70	71	3.59	\$477	\$211	\$1772	\$2568
BRTMLD66	1.25 x 63 x 30	85	66	3.28	\$455	\$213	\$1779	\$2575
BRTMLD60	1.25 x 57 x 30	92.5	60	2.97	\$440	\$150	\$1787	\$2575
BRTMLD54	1.25 x 51 x 30	92.5	54	2.66	\$418	\$150	\$1685	\$2433
BRTMLD48	1.25 x 45 x 30	85	48	2.34	\$403	\$150	\$695	\$1154
BRTMLD42	1.25 x 39 x 30	100	42	2.03	\$388	\$150	\$704	\$1077
BRTMLD36	1.25 x 33 x 30	100	38	1.90	\$373	\$150	\$385	\$835

Parallel divider for single tables. Divider infill can be specified in low pressure laminate (**LP**), high pressure laminate (**HP**), dry erase whiteboard (**DE**) or dry erase magnetic whiteboard (**DM**) user side only. Fastens to the underside of the worksurface. 0.6" gap between worksurface and divider allows for cable pass thru. Installed divider reaches 15.7" up and 15" down from top of worksurface. 36" to 66" dividers include 2 support brackets. 72" to 84" dividers include 3 support brackets. Brackets are available in all standard Bridges II paint finishes.

- 72" - 84" dividers require 3 support brackets and cannot be used with worksurfaces that have a single access door

BRTADPCPP	1.5 x 4.75 x 99	65	13	.48	\$459			
-----------	-----------------	----	----	-----	--------------	--	--	--

Brings ceiling feed conduit and data cables from the ceiling down to Power Troughs at desk height. Accommodates 10' ceiling heights. Two part construction allows power/data conduit lay-in. Attaches to a junction between two adjacent Power Troughs in back-to-back applications only. Not for use on single sided Bridges II troughs. Includes mounting hardware and ceiling bezel. Painted Finish.

- Screens must be specified 6" shorter than the nominal worksurface dimension in order to accommodate this ceiling feed.

Required Specifications

Fabric
Finish
Bracket finish*

BACK-TO-BACK WELLNESS SCREENS

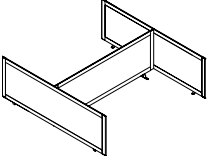

24" H Back-to-Back Wellness Screen

MODEL#	DIMENSIONS D x W x H	FREIGHT CLASS	WT./LBS.	CUBIC FT.	LIST PRICE
BRTADP5136H24	50.50 x 36 x 24.63	150	33	6.31	\$1204
BRTADP5142H24	50.50 x 42 x 24.63	150	34.50	7.36	\$1228
BRTADP5148H24	50.50 x 48 x 24.63	150	36	8.42	\$1254
BRTADP5154H24	50.50 x 54 x 24.63	250	37.50	9.47	\$1279
BRTADP5160H24	50.50 x 60 x 24.63	250	39	10.52	\$1304
BRTADP5166H24	50.50 x 66 x 24.63	250	40.50	11.57	\$1329
BRTADP5172H24	50.50 x 72 x 24.63	250	42	12.63	\$1353
BRTADP5178H24	50.50 x 78 x 24.63	250	43.50	13.68	\$1379
BRTADP5184H24	50.50 x 84 x 24.63	250	45	14.73	\$1404
BRTADP6336H24	62.50 x 36 x 24.63	150	46.50	7.81	\$1302
BRTADP6342H24	62.50 x 42 x 24.63	150	48	9.11	\$1326
BRTADP6348H24	62.50 x 48 x 24.63	150	49.50	10.42	\$1352
BRTADP6354H24	62.50 x 54 x 24.63	150	51	11.72	\$1377
BRTADP6360H24	62.50 x 60 x 24.63	150	52.50	13.02	\$1401
BRTADP6366H24	62.50 x 66 x 24.63	250	54	14.32	\$1427
BRTADP6372H24	62.50 x 72 x 24.63	250	55	15.63	\$1452
BRTADP6378H24	62.50 x 78 x 24.63	250	57.35	16.93	\$1478
BRTADP6384H24	62.50 x 84 x 24.63	250	58.50	18.23	\$1503

Powder coated aluminum frame, translucent ribbed polycarbonate. Includes all hardware to connect. Brackets are painted steel. Side dividers extend 6.25" from the front edge of each surface. Center divider sits over the gap between the worksurface allowing for cable pass-through to trough. Gap for each side is approximately 1". Width and depth are nominal sizes representing the sizes of the Bridges configuration. Allow for .25" overhang at the sides and 6.25" at the front. Frame and hardware available in all Bridges paint finishes. End trim cap is only available in Charcoal (CHR).

- **BRTADP51xxH24 are for configurations with 24" deep surfaces.**
- **BRTADP63xxH24 are for configurations with 30" deep surfaces.**

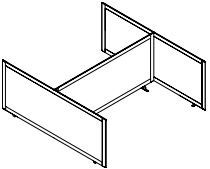

30" H Back-to-Back Wellness Screen

BRTADP5136H30	50.50 x 36 x 30.63	150	35.50	6.31	\$1335
BRTADP5142H30	50.50 x 42 x 30.63	150	37	7.36	\$1364
BRTADP5148H30	50.50 x 48 x 30.63	150	38.50	8.42	\$1392
BRTADP5154H30	50.50 x 54 x 30.63	150	40	9.47	\$1422
BRTADP5160H30	50.50 x 60 x 30.63	250	41.50	10.52	\$1451
BRTADP5166H30	50.50 x 66 x 30.63	250	43	11.57	\$1481
BRTADP5172H30	50.50 x 72 x 30.63	250	44.50	12.63	\$1509
BRTADP5178H30	50.50 x 78 x 30.63	250	46	13.68	\$1537
BRTADP5184H30	50.50 x 84 x 30.63	250	47.50	14.73	\$1567
BRTADP6336H30	62.50 x 36 x 30.63	125	49	7.81	\$1500
BRTADP6342H30	62.50 x 42 x 30.63	150	50.50	9.11	\$1528
BRTADP6348H30	62.50 x 48 x 30.63	150	52	10.42	\$1558
BRTADP6354H30	62.50 x 54 x 30.63	150	53.50	11.72	\$1586
BRTADP6360H30	62.50 x 60 x 30.63	150	55	13.02	\$1616
BRTADP6366H30	62.50 x 66 x 30.63	250	56.50	14.32	\$1645
BRTADP6372H30	62.50 x 72 x 30.63	250	58	15.63	\$1673
BRTADP6378H30	62.50 x 78 x 30.63	250	59.50	16.93	\$1703
BRTADP6384H30	62.50 x 84 x 30.63	250	61	18.23	\$1731

Powder coated aluminum frame, translucent ribbed polycarbonate. Includes all hardware to connect. Brackets are painted steel. Side dividers extend 6.25" from the front edge of each surface. Center divider sits over the gap between the worksurface allowing for cable pass-through to trough. Gap for each side is approximately 1". Width and depth are nominal sizes representing the sizes of the Bridges configuration. Allow for .25" overhang at the sides and 6.25" at the front. Frame and hardware available in all Bridges paint finishes. End trim cap is only available in Charcoal (CHR).

- **BRTADP51xxH30 are for configurations with 24" deep surfaces.**
- **BRTADP63xxH30 are for configurations with 30" deep surfaces.**

Required Specifications
Frame finish

BACK-TO-BACK WELLNESS SCREENS

MODEL# DIMENSIONS FREIGHT CLASS WT/LBS. CUBIC FT. LIST PRICE

D x W x H

BRTADPE5136H24	50.50 x 36 x 24.63	150	26.35	6.31	\$816
BRTADPE5142H24	50.50 x 42 x 24.63	250	27.85	7.36	\$840
BRTADPE5148H24	50.50 x 48 x 24.63	250	29.35	8.42	\$865
BRTADPE5154H24	50.50 x 54 x 24.63	250	30.85	9.47	\$890
BRTADPE5160H24	50.50 x 60 x 24.63	250	32.35	10.52	\$916
BRTADPE5166H24	50.50 x 66 x 24.63	250	33.85	11.57	\$941
BRTADPE5172H24	50.50 x 72 x 24.63	250	35.35	12.63	\$967
BRTADPE5178H24	50.50 x 78 x 24.63	250	36.85	13.68	\$991
BRTADPE5184H24	50.50 x 84 x 24.63	250	38.35	14.73	\$1016

BRTADPE6336H24	62.50 x 36 x 24.63	150	39.85	7.81	\$864
BRTADPE6342H24	62.50 x 42 x 24.63	150	41.35	9.11	\$889
BRTADPE6348H24	62.50 x 48 x 24.63	150	42.85	10.42	\$914
BRTADPE6354H24	62.50 x 54 x 24.63	250	44.35	11.72	\$940
BRTADPE6360H24	62.50 x 60 x 24.63	250	45.85	13.02	\$965
BRTADPE6366H24	62.50 x 66 x 24.63	250	47.35	14.32	\$991
BRTADPE6372H24	62.50 x 72 x 24.63	250	48.85	15.63	\$1015
BRTADPE6378H24	62.50 x 78 x 24.63	250	50.35	16.93	\$1040
BRTADPE6384H24	62.50 x 84 x 24.63	250	51.85	18.23	\$1066

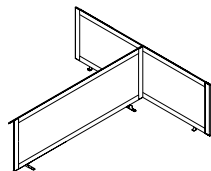

24" H Back-to-Back Wellness Screen Extension Kit

Intended to always connect to Back-to-Back Divider Screen Kit. Powder coated aluminum frame, translucent ribbed polycarbonate. Includes all hardware to connect. Brackets are painted steel. Side dividers extend 6.25" from the front edge of each surface. Center divider sits over the gap between the worksurface allowing for cable pass-through to trough. Gap for each side is approximately 1". Width and depth are nominal sizes representing the sizes of the Bridges configuration. Allow for .25" overhang at the sides and 6.25" at the front. Frame and hardware available in all Bridges paint finishes. End trim cap is only available in Charcoal (CHR).

- **BRTADPE51xxH24 are for configurations with 24" deep surfaces.**
- **BRTADPE63xxH24 are for configurations with 30" deep surfaces.**

BRTADPE5136H30	50.50 x 36 x 30.63	150	28.85	6.31	\$896
BRTADPE5142H30	50.50 x 42 x 30.63	150	30.35	7.36	\$926
BRTADPE5148H30	50.50 x 48 x 30.63	250	31.85	8.42	\$955
BRTADPE5154H30	50.50 x 54 x 30.63	250	33.35	9.47	\$985
BRTADPE5160H30	50.50 x 60 x 30.63	250	34.85	10.52	\$1013
BRTADPE5166H30	50.50 x 66 x 30.63	250	36.35	11.57	\$1042
BRTADPE5172H30	50.50 x 72 x 30.63	250	37.85	12.63	\$1072
BRTADPE5178H30	50.50 x 78 x 30.63	250	39.35	13.68	\$1099
BRTADPE5184H30	50.50 x 84 x 30.63	250	40.85	14.73	\$1128

BRTADPE6336H30	62.50 x 36 x 30.63	150	42.35	7.81	\$953
BRTADPE6342H30	62.50 x 42 x 30.63	150	43.85	9.11	\$983
BRTADPE6348H30	62.50 x 48 x 30.63	150	45.35	10.42	\$1012
BRTADPE6354H30	62.50 x 54 x 30.63	250	46.85	11.72	\$1040
BRTADPE6360H30	62.50 x 60 x 30.63	250	48.35	13.02	\$1070
BRTADPE6366H30	62.50 x 66 x 30.63	250	49.85	14.32	\$1098
BRTADPE6372H30	62.50 x 72 x 30.63	250	51.35	15.63	\$1128
BRTADPE6378H30	62.50 x 78 x 30.63	250	52.85	16.93	\$1156
BRTADPE6384H30	62.50 x 84 x 30.63	250	54.35	18.23	\$1185

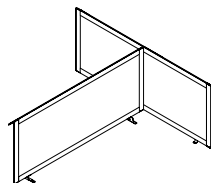

30" H Back-to-Back Wellness Screen Extension Kit

Intended to always connect to Back-to-Back Divider Screen Kit. Powder coated aluminum frame, translucent ribbed polycarbonate. Includes all hardware to connect. Brackets are painted steel. Side dividers extend 6.25" from the front edge of each surface. Center divider sits over the gap between the worksurface allowing for cable pass-through to trough. Gap for each side is approximately 1". Width and depth are nominal sizes representing the sizes of the Bridges configuration. Allow for .25" overhang at the sides and 6.25" at the front. Frame and hardware available in all Bridges paint finishes. End trim cap is only available in Charcoal (CHR).

- **BRTADPE51xxH30 are for configurations with 24" deep surfaces.**
- **BRTADPE63xxH30 are for configurations with 30" deep surfaces.**

Required Specifications

Frame finish

SINGLE TABLE WELLNESS SCREENS

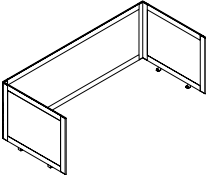

24" H Single Table Wellness Screen

MODEL#	DIMENSIONS D x W x H	FREIGHT CLASS	WT./LBS.	CUBIC FT.	LIST PRICE
BRTADP2436H24	31.75 x 36 x 24.63	125	26.55	3.97	\$831
BRTADP2442H24	31.75 x 42 x 24.63	125	28.10	4.63	\$857
BRTADP2448H24	31.75 x 48 x 24.63	150	29.65	5.29	\$881
BRTADP2454H24	31.75 x 54 x 24.63	150	31.20	5.95	\$907
BRTADP2460H24	31.75 x 60 x 24.63	150	32.75	6.61	\$932
BRTADP2466H24	31.75 x 66 x 24.63	150	34.30	7.28	\$956
BRTADP2472H24	31.75 x 72 x 24.63	150	35.85	7.94	\$982
BRTADP2478H24	31.75 x 78 x 24.63	150	37.40	8.60	\$1007
BRTADP2484H24	31.75 x 84 x 24.63	150	38.95	9.26	\$1033
BRTADP3036H24	37.75 x 36 x 24.63	100	40.50	4.72	\$890
BRTADP3042H24	37.75 x 42 x 24.63	125	42.05	5.51	\$916
BRTADP3048H24	37.75 x 48 x 24.63	125	43.60	6.29	\$941
BRTADP3054H24	37.75 x 54 x 24.63	150	42.15	7.08	\$967
BRTADP3060H24	37.75 x 60 x 24.63	150	46.70	7.87	\$991
BRTADP3066H24	37.75 x 66 x 24.63	150	48.25	8.65	\$1016
BRTADP3072H24	37.75 x 72 x 24.63	150	49.80	9.44	\$1042
BRTADP3078H24	37.75 x 78 x 24.63	150	51.35	10.22	\$1067
BRTADP3084H24	37.75 x 84 x 24.63	150	52.90	11.01	\$1092

Powder coated aluminum frame, translucent ribbed polycarbonate. Includes all hardware to connect. Brackets are painted steel. Side dividers extend 6.25" from the front edge of each surface. Back divider extends over the back edge of the worksurface by 1.5", allowing for cable pass-through to trough. Width and depth are nominal sizes representing the sizes of the Bridges configuration. Allow for .25" overhang at the sides, 1.5" at the back, and 6.25" at the front. Frame and hardware available in all Bridges paint finishes. End trim cap is only available in Charcoal (CHR).

- **BRTADP24xxH24 are for configurations with 24" deep surfaces.**
- **BRTADP30xxH24 are for configurations with 30" deep surfaces.**

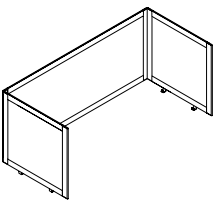

30" H Single Table Wellness Screen

BRTADP2436H30	31.75 x 36 x 30.63	125	28.85	3.97	\$932
BRTADP2442H30	31.75 x 42 x 30.63	125	30.40	4.63	\$962
BRTADP2448H30	31.75 x 48 x 30.63	125	31.95	5.29	\$991
BRTADP2454H30	31.75 x 54 x 30.63	150	33.50	5.95	\$1019
BRTADP2460H30	31.75 x 60 x 30.63	150	35.05	6.61	\$1049
BRTADP2466H30	31.75 x 66 x 30.63	150	36.60	7.28	\$1077
BRTADP2472H30	31.75 x 72 x 30.63	150	38.15	7.94	\$1107
BRTADP2478H30	31.75 x 78 x 30.63	150	39.70	8.60	\$1135
BRTADP2484H30	31.75 x 84 x 30.63	150	41.25	9.26	\$1164
BRTADP3036H30	37.75 x 36 x 30.63	100	42.80	4.72	\$989
BRTADP3042H30	37.75 x 42 x 30.63	100	44.35	5.51	\$1019
BRTADP3048H30	37.75 x 48 x 30.63	125	45.90	6.29	\$1048
BRTADP3054H30	37.75 x 54 x 30.63	125	47.45	7.08	\$1075
BRTADP3060H30	37.75 x 60 x 30.63	125	49	7.87	\$1105
BRTADP3066H30	37.75 x 66 x 30.63	150	50.55	8.65	\$1134
BRTADP3072H30	37.75 x 72 x 30.63	150	52.10	9.44	\$1162
BRTADP3078H30	37.75 x 78 x 30.63	150	53.65	10.22	\$1192
BRTADP3084H30	37.75 x 84 x 30.63	150	55.20	11.01	\$1221

Powder coated aluminum frame, translucent ribbed polycarbonate. Includes all hardware to connect. Brackets are painted steel. Side dividers extend 6.25" from the front edge of each surface. Back divider extends over the back edge of the worksurface by 1.5", allowing for cable pass-through to trough. Width and depth are nominal sizes representing the sizes of the Bridges configuration. Allow for .25" overhang at the sides, 1.5" at the back, and 6.25" at the front. Frame and hardware available in all Bridges paint finishes. End trim cap is only available in Charcoal (CHR).

- **BRTADP24xxH30 are for configurations with 24" deep surfaces.**
- **BRTADP30xxH30 are for configurations with 30" deep surfaces.**

Required Specifications

Frame finish

SINGLE TABLE WELLNESS SCREENS

MODEL# DIMENSIONS FREIGHT CLASS WT./LBS. CUBIC FT. LIST PRICE

D x W x H

BRTADPE2436H24	31.75 x 36 x 24.63	150	21.05	3.97	\$623
BRTADPE2442H24	31.75 x 42 x 24.63	150	22.60	4.63	\$684
BRTADPE2448H24	31.75 x 48 x 24.63	150	24.15	5.29	\$710
BRTADPE2454H24	31.75 x 54 x 24.63	150	25.70	5.95	\$734
BRTADPE2460H24	31.75 x 60 x 24.63	150	27.25	6.61	\$759
BRTADPE2466H24	31.75 x 66 x 24.63	250	28.80	7.28	\$785
BRTADPE2472H24	31.75 x 72 x 24.63	250	30.35	7.94	\$810
BRTADPE2478H24	31.75 x 78 x 24.63	250	31.90	8.60	\$835
BRTADPE2484H24	31.75 x 84 x 24.63	250	33.45	9.26	\$859

BRTADPE3036H24	37.75 x 36 x 24.63	125	35	4.72	\$648
BRTADPE3042H24	37.75 x 42 x 24.63	125	36.55	5.51	\$708
BRTADPE3048H24	37.75 x 48 x 24.63	125	38.10	6.29	\$734
BRTADPE3054H24	37.75 x 54 x 24.63	150	39.65	7.08	\$759
BRTADPE3060H24	37.75 x 60 x 24.63	150	41.20	7.87	\$785
BRTADPE3066H24	37.75 x 66 x 24.63	150	42.75	8.65	\$808
BRTADPE3072H24	37.75 x 72 x 24.63	150	44.30	9.44	\$833
BRTADPE3078H24	37.75 x 78 x 24.63	150	45.85	10.01	\$859
BRTADPE3084H24	37.75 x 84 x 24.63	150	47.40	10.01	\$884

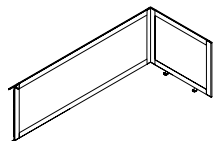

24" H Single Table Wellness Screen Extension Kit

Intended to always connect to Single Table Divider Screen Kit. Powder coated aluminum frame, translucent ribbed polycarbonate. Includes all hardware to connect. Brackets are painted steel. Side dividers extend 6.25" from the front edge of each surface. Back divider extends over the back edge of the worksurface by 1.5", allowing for cable pass-through to trough. Width and depth are nominal sizes representing the sizes of the Bridges configuration. Allow for .25" overhang at the sides, 1.5" at the back, and 6.25" at the front. Frame and hardware available in all Bridges paint finishes. End trim cap is only available in Charcoal (CHR).

- **BRTADPE24xxH24 are for configurations with 24" deep surfaces.**
- **BRTADPE30xxH24 are for configurations with 30" deep surfaces.**

BRTADPE2436H30	31.75 x 36 x 30.63	150	22.85	3.97	\$686
BRTADPE2442H30	31.75 x 42 x 30.63	150	24.40	4.63	\$750
BRTADPE2448H30	31.75 x 48 x 30.63	150	25.95	5.29	\$779
BRTADPE2454H30	31.75 x 54 x 30.63	150	27.50	5.95	\$807
BRTADPE2460H30	31.75 x 60 x 30.63	150	29.05	6.61	\$837
BRTADPE2466H30	31.75 x 66 x 30.63	150	30.60	7.28	\$865
BRTADPE2472H30	31.75 x 72 x 30.63	150	32.15	7.94	\$893
BRTADPE2478H30	31.75 x 78 x 30.63	250	33.70	8.60	\$923
BRTADPE2484H30	31.75 x 84 x 30.63	250	35.25	9.26	\$952

BRTADPE3036H30	37.75 x 36 x 30.63	125	36.80	4.72	\$714
BRTADPE3042H30	37.75 x 42 x 30.63	125	38.35	5.51	\$779
BRTADPE3048H30	37.75 x 48 x 30.63	125	39.90	6.29	\$807
BRTADPE3054H30	37.75 x 54 x 30.63	150	41.45	7.08	\$836
BRTADPE3060H30	37.75 x 60 x 30.63	150	43	7.87	\$865
BRTADPE3066H30	37.75 x 66 x 30.63	150	44.55	8.65	\$893
BRTADPE3072H30	37.75 x 72 x 30.63	150	46.10	9.44	\$922
BRTADPE3078H30	37.75 x 78 x 30.63	150	47.65	10.22	\$952
BRTADPE3084H30	37.75 x 84 x 30.63	150	49.20	11.01	\$980

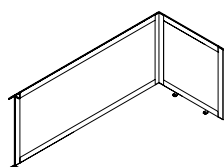

30" H Single Table Wellness Screen Extension Kit

Intended to always connect to Single Table Divider Screen Kit. Powder coated aluminum frame, translucent ribbed polycarbonate. Includes all hardware to connect. Brackets are painted steel. Side dividers extend 6.25" from the front edge of each surface. Back divider extends over the back edge of the worksurface by 1.5", allowing for cable pass-through to trough. Width and depth are nominal sizes representing the sizes of the Bridges configuration. Allow for .25" overhang at the sides, 1.5" at the back, and 6.25" at the front. Frame and hardware available in all Bridges paint finishes. End trim cap is only available in Charcoal (CHR).

- **BRTADPE24xxH30 are for configurations with 24" deep surfaces.**
- **BRTADPE30xxH30 are for configurations with 30" deep surfaces.**

Required Specifications

Frame finish

STORAGE

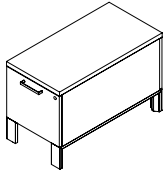

File Pedestal

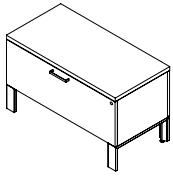

Lateral File Drawer

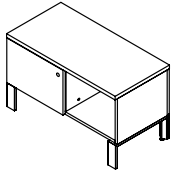

Sliding Door Storage

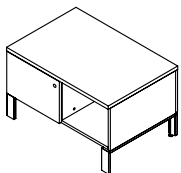

Shared Sliding Door Storage

MODEL#	DIMENSIONS D x W x H	FREIGHT CLASS	WT./LBS.	CUBIC FT.	LIST PRICE	HP ADD
BRT21BF18L	18 x 15.5 x 21	70	58	3.39	\$631	\$45
BRT21BF24L	24 x 15.5 x 21	85	64	4.52	\$732	\$45
BRT21BF30L	30 x 15.5 x 21	85	72	5.65	\$804	\$58
BRT21BF18C	18 x 15.5 x 21	70	58	3.39	\$631	\$45
BRT21BF24C	24 x 15.5 x 21	85	64	4.52	\$788	\$45
BRT21BF30C	30 x 15.5 x 21	85	72	5.65	\$861	\$58

Can join with other 21" h storage units of corresponding depth to form a spine or slide out on casters to serve as an additional worksurface. One file drawer. Fits under table beams even with optional seat cushion. Optional cable basket suspends off storage unit's bottom and manages cables and data cables under storage spine. (Leveler models only.) 1" top; metal handles; powder coated aluminum or anodized aluminum legs. Specify "L" models for levelers or "C" models for 40mm white/grey locking casters.

- Anodized Aluminum Leg - Add **\$61** list upcharge
- 18" deep storage components will not accept legal size paper

BRT21F30L	18 x 30 x 21	92.5	77	6.56	\$846	\$58
BRT21F36L	18 x 36 x 21	92.5	84	7.87	\$933	\$74
BRT21F42L	18 x 42 x 21	92.5	92	9.18	\$1090	\$74

Can join with other 21" h storage units of corresponding depth to form a spine. One file drawer. Optional 15.5" x 18" cushion. Optional cable basket suspends off storage unit's bottom and manages cables along the horizontal plane. 1" top; metal handles; powder coated aluminum or anodized aluminum legs.

- Anodized Aluminum Leg - Add **\$61** list upcharge
- 18" deep storage components will not accept legal size paper

BRT21LS30L	18 x 30 x 21	100	53	6.56	\$689	\$58
BRT21LS36L	18 x 36 x 21	125	60	7.87	\$761	\$58
BRT21LS42L	18 x 42 x 21	125	67	9.18	\$833	\$58

Can join with other 21" h storage units of corresponding depth to form a spine. Optional 15.5" x 18" cushion. Storage compartment internal height: 12.36" Sliding door locks on left side. Optional cable basket suspends off storage unit's bottom and manages cables along the horizontal plane. 1" top; metal handles; powder coated aluminum or anodized aluminum legs.

- Anodized Aluminum Leg - Add **\$61** list upcharge
- 18" deep storage components will not accept legal size paper

BRT21LSS30L	24 x 30 x 21	125	69	8.75	\$961	\$58
BRT21LSS36L	24 x 36 x 21	125	78	10.50	\$1047	\$74
BRT21LSS42L	24 x 42 x 21	125	87	12.25	\$1132	\$87

Offers two 11" deep storage compartments on either side. For use beside a table assembly, between two adjacent workstations. Can join with other 21" h, 24" d storage units to form a spine. Optional 15.5" x 18" cushion. Storage compartment internal height: 12.36" Sliding door locks on left side. Optional cable basket suspends off storage unit's bottom and manages cables along the horizontal plane. 1" top; metal handles; powder coated aluminum or anodized aluminum legs.

- Anodized Aluminum Leg - Add **\$61** list upcharge

Required Specifications

Metal finish
 Top finish Edge finish
 Chassis finish
 Drawer/door front finish

Optional Specifications

Anodized Aluminum Leg
 HP laminate (tops only)
 Cable Basket

STORAGE

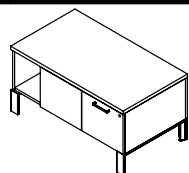

Shared File/Open Storage

MODEL#	DIMENSIONS	FREIGHT CLASS	WT/LBS.	CUBIC FT.	LIST PRICE	HP ADD
--------	------------	---------------	---------	-----------	------------	--------

D x W x H

BRT21LSO42L	24 x 42 x 21	100	124	14	\$1290	\$102
-------------	--------------	-----	-----	----	--------	-------

Offers storage compartments on either side. For use between two adjacent workstations. Can join with other 21”h, 24”d storage units to form a spine or serve as an additional return worksurface or ad-hoc guest seating with optional 15.5” x 18”cushion. One locking file drawer, One open compartment per side. Storage compartment internal height without shelf: 12.36”. Optional cable basket suspends off storage unit’s bottom and manages cables along the horizontal plane. 1” top; metal handles; powder coated aluminum or anodized aluminum legs.

- Anodized Aluminum Leg - Add **\$61** list upcharge

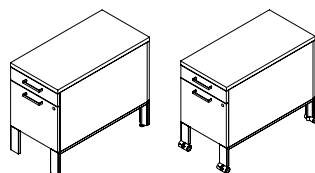

Box/File Pedestal

BRT25BF18L	18 x 15.5 x 25	70	69	3.89	\$717	\$45
BRT25BF24L	24 x 15.5 x 25	85	74	5.02	\$833	\$45
BRT25BF30L	30 x 15.5 x 25	85	82	6.15	\$904	\$58
BRT25BF18C	18 x 15.5 x 25	70	69	3.89	\$775	\$45
BRT25BF24C	24 x 15.5 x 25	85	74	5.02	\$889	\$45
BRT25BF30C	30 x 15.5 x 25	85	82	6.15	\$961	\$58

Can join with other 25”h storage units of corresponding depth to form a spine or slide out on casters to serve as an additional worksurface. One box drawer, one file drawer. Optional cable basket suspends off storage unit’s bottom and manages cables and data cables under storage spine. (Leveler models only.) 1” top; metal handles; powder coated aluminum or anodized aluminum legs. Specify “L” models for levelers or “C” models for 40mm white/grey locking casters. Black pencil tray included.

- Anodized Aluminum Leg - Add **\$61** list upcharge
- 18” deep storage components will not accept legal size paper

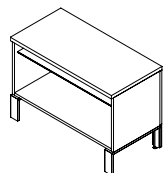

Open Storage

BRT25LO30L	18 x 30 x 25	125	49	7.81	\$502	\$102
BRT25LO36L	18 x 36 x 25	150	55	9.37	\$631	\$58
BRT25LO42L	18 x 42 x 25	150	62	10.93	\$689	\$74

One adjustable shelf. Positioned beside a table assembly or between two adjacent workstations. Can join with other 25”h, 18”d storage units to form a storage spine, credenza or serve as an additional return worksurface. Open compartment with glass adjustable shelf. Storage compartment internal height without shelf: 15.8” Optional cable basket suspends off storage unit’s bottom and manages cables along the horizontal plane. 1” top; metal handles; powder coated aluminum or anodized aluminum legs.

- Anodized Aluminum Leg - Add **\$61** list upcharge
- 18” deep storage components will not accept legal size paper

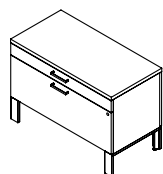

Lateral Box/File Storage Unit

BRT25LBF30L	18 x 30 x 25	92.5	88	7.81	\$975	\$58
BRT25LBF36L	18 x 36 x 25	92.5	96	9.37	\$1119	\$58
BRT25LBF42L	18 x 42 x 25	100	104	10.93	\$1219	\$74

Positioned beside a table assembly or between two adjacent workstations. Can join with other 25”h, 18”d storage units to form a storage spine, credenza or serve as an additional return worksurface. One locking file drawer, one box drawer. Optional cable basket suspends off storage unit’s bottom and manages cables along the horizontal plane. 1” top; metal handles; powder coated aluminum or anodized aluminum legs. Black pencil tray included.

- Anodized Aluminum Leg - Add **\$61** list upcharge
- 18” deep storage components will not accept legal size paper
- 25” high Bridges storage should not be used under back-to-back Bridges table applications using Below Worksurface Trough. Storage will not fit under the trough

Required Specifications

Metal finish	
Top finish	Edge finish
Chassis finish	
Drawer/door front finish	

Optional Specifications

Anodized Aluminum Leg
HP laminate (tops only)
Cable Basket
Cushion (BRT21LSO42L)

STORAGE

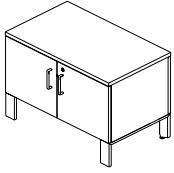

Two Door Storage Unit

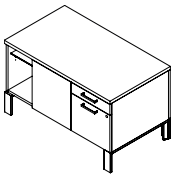

Shared Storage Unit

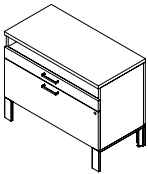

Lateral Box/File Open Storage Unit

MODEL#	DIMENSIONS D x W x H	FREIGHT CLASS	WT/LBS.	CUBIC FT.	LIST PRICE	HP ADD
BRT25L2D3018	18 x 30 x 25	xx	69	7.81	\$932	\$90
BRT25L2D3618	18 x 36 x 25	92.5	78	9.37	\$1004	\$109
BRT25L2D4218	18 x 42 x 25	100	90	10.93	\$1055	\$124
BRT25L2D3024	24 x 30 x 25	xx	75	7.81	\$1066	\$120
BRT25L2D3624	24 x 36 x 25	92.5	84	9.37	\$1154	\$143
BRT25L2D4224	24 x 42 x 25	100	96	10.93	\$1241	\$126

Positioned usually beside a table assembly or between two adjacent workstations. Can join with other 25"h, 18"d storage units to form a storage spine, credenza or serve as an additional return worksurface. Two lockable doors, glass shelf included. Storage compartment internal height is 16.5". Optional cable basket suspends off storage unit's bottom and manages cables along the horizontal plane. 1" top; metal handles; powder coated aluminum or anodized aluminum legs.

- Anodized Aluminum Leg - Add **\$61** list upcharge
- 25" high Bridges storage should not be used under back-to-back Bridges table applications using Below Worksurface Trough. Storage will not fit under the trough

BRT25LBF042L	24 x 42 x 25	100	154	16.66	\$1620	\$87
--------------	--------------	-----	-----	-------	---------------	-------------

Offers storage compartments on either side. For use between two adjacent workstations. Can join with other 25"h, 24"d storage units to form a spine or serve as an additional return worksurface or ad-hoc guest seating with optional 15.5" x 18" cushion. One locking file drawer, One open compartment per side. Storage compartment internal height without shelf: 12.36". Optional cable basket suspends off storage unit's bottom and manages cables along the horizontal plane. 1" top; metal handles; powder coated aluminum or anodized aluminum legs. Black pencil tray included.

- Anodized Aluminum Leg - Add **\$61** list upcharge
- 25" high Bridges storage should not be used under back-to-back Bridges table applications using Below Worksurface Trough. Storage will not fit under the trough

BRT29LOBF30L	18 x 30 x 29	92.5	100	9.06	\$1113	\$50
BRT29LOBF36L	18 x 36 x 29	92.5	111	10.87	\$1248	\$74
BRT29LOBF42L	18 x 42 x 29	100	122	12.68	\$1391	\$87

Positioned beside a table assembly or between two adjacent workstations. Units are level with Bridges tops and can join other 29"h, 18"d storage units to form a credenza or serve as an additional return worksurface. One locking file drawer, one box drawer and one open compartment. Storage compartment internal height: 3.9". Optional cable basket suspends off storage unit's bottom and manages cables along the horizontal plane. 1" top; metal handles; powder coated aluminum or anodized aluminum legs. Black pencil tray included.

- Anodized Aluminum Leg - Add **\$61** list upcharge
- 18" deep storage components will not accept legal size paper

Required Specifications

Top finish
Chassis finish
Drawer/door front finish
Metal finish (legs)

Edge finish

Optional Specifications

Anodized Aluminum Leg
HP laminate (tops only)
Cable Basket (Storage Units)
Elevated Shelf Binder Bin (shared storage)

STORAGE

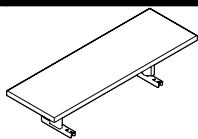

Center Mount Shelf

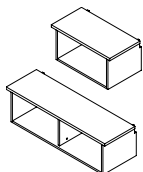
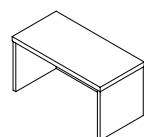
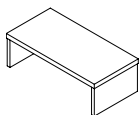

Table Mounted End Shelf*



Single Sided Elevated Table Shelf*

MODEL#	DIMENSIONS	FREIGHT CLASS	WT./LBS.	CUBIC FT.	LIST PRICE	HP ADD
--------	------------	---------------	----------	-----------	------------	--------

D x W x H

BRTCMS36	12 x 36 x 6.75	100	15.20	1.69	\$273	N/A
BRTCMS30	12 x 30 x 6.75	100	12.60	1.41	\$192	N/A

Open, shared center mount shelf "floats" 6.75" above the gap formed by two back-to-back worksurfaces. Accepts BRTESSBBIN Elevated Shelf Binder Bin - The 30" w shelf accommodates two; 36" w shelf accommodates up to three. Shelves overhang the support structure by 6" on either side. Aluminum/die cast structure attaches to the underside of both worksurfaces.

- Not compatible with BRTEETA Above Worksurface Power Trough and Worksurfaces with Access Doors
- Anodized Aluminum support structure - Add **\$59** list upcharge

BRTTES24	15.5 x 24 x 15	100	29	3.22	\$531	\$45
BRTTES30	15.5 x 30 x 15	100	34	4.03	\$582	\$51
BRTTES51	15.5 x 50.5 x 15	100	57	6.79	\$961	\$94
BRTTES63	15.5 x 62.5 x 15	100	68	8.40	\$1055	\$122

Single or double open shelf/extended worksurface. Secured to the end of single or back-to-back Bridges table. All mounting hardware included. Storage compartment internal height: 13.25". 1" top.

BRTSTS0824	12 x 24 x 8	92.5	14	1.33	\$187	\$58
BRTSTS0830	12 x 30 x 8	100	16	1.66	\$216	\$58
BRTSTS0851	12 x 50.5 x 8	100	25	2.80	\$345	\$87
BRTSTS0863	12 x 62.5 x 8	100	28	3.47	\$389	\$130

BRTSTS1324	12 x 24 x 13	100	18	2.16	\$202	\$58
BRTSTS1330	12 x 30 x 13	125	21	2.70	\$231	\$58
BRTSTS1351	12 x 50.5 x 13	125	32	4.55	\$345	\$87
BRTSTS1363	12 x 62.5 x 13	125	38	5.64	\$402	\$116

BRTSTS1624	12 x 24 x 16	125	19	2.66	\$231	\$58
BRTSTS1630	12 x 30 x 16	100	29	3.33	\$273	\$58
BRTSTS1651	12 x 50.5 x 16	150	33	5.61	\$402	\$102
BRTSTS1663	12 x 62.5 x 16	150	39	6.94	\$460	\$130

Secured perpendicularly to the single or back-to-back Bridges table. Integrated anodized aluminum accessory rail. White cut out and accessory rail trims. Optional Elevated Shelf Binder Bin (BRTESSBBIN) rests on top surface for enhanced privacy. 8" h provides additional storage space without obstructing view and reaches 16" module height when combined w/8" h Binder shelf. Internal height: 6.6". 16" h lines up with top of 16" table dividers (15.8"). Specify 12" narrower shared elevated shelf immediately adjacent to the perpendicular elevated shelf. Internal height: 14.6".

- Please refer to the **Compatibility Guide** on page 406 to determine available accessories

Required Specifications

Top finish
Edge finish
Chassis/Accent Finish

Optional Specifications

HP laminate* (tops only)
Elevated Shelf Binder Bin

STORAGE

MODEL#	DIMENSIONS	FREIGHT CLASS	WT./LBS.	CUBIC FT.	LIST PRICE	HP ADD
--------	------------	---------------	----------	-----------	------------	--------

D x W x H

BRTBTS0836	12 x 36 x 8	100	16	2	\$288	\$58
BRTBTS0842	12 x 42 x 8	100	19	2.33	\$316	\$58
BRTBTS0848	12 x 48 x 8	125	21	2.66	\$345	\$87
BRTBTS0854	12 x 54 x 8	125	23	3	\$360	\$102
BRTBTS0860	12 x 60 x 8	125	26	3.33	\$402	\$116
BRTBTS0866	12 x 66 x 8	125	28	3.66	\$431	\$130
BRTBTS0872	12 x 72 x 8	125	30	4	\$460	\$130
BRTBTS0878	12 x 78 x 8	125	32	4.33	\$489	\$145
BRTBTS0884	12 x 84 x 8	125	35	4.66	\$518	\$158
BRTBTS1336	12 x 36 x 13	125	22	3.25	\$345	\$74
BRTBTS1342	12 x 42 x 13	125	25	3.79	\$389	\$74
BRTBTS1348	12 x 48 x 13	125	28	4.33	\$418	\$102
BRTBTS1354	12 x 54 x 13	125	30	4.87	\$460	\$102
BRTBTS1360	12 x 60 x 13	150	33	5.86	\$489	\$102
BRTBTS1366	12 x 66 x 13	150	36	6.45	\$502	\$174
BRTBTS1372	12 x 72 x 13	125	39	6.50	\$574	\$145
BRTBTS1378	12 x 78 x 13	150	42	7.04	\$617	\$145
BRTBTS1384	12 x 84 x 13	150	44	7.58	\$660	\$158
BRTBTS1636	12 x 36 x 16	125	25	4	\$360	\$58
BRTBTS1642	12 x 42 x 16	125	28	4.66	\$402	\$87
BRTBTS1648	12 x 48 x 16	150	31	5.33	\$445	\$87
BRTBTS1654	12 x 54 x 16	150	34	6	\$473	\$116
BRTBTS1660	12 x 60 x 16	150	38	6.66	\$518	\$116
BRTBTS1666	12 x 66 x 16	150	41	7.33	\$560	\$116
BRTBTS1672	12 x 72 x 16	150	44	8	\$603	\$130
BRTBTS1678	12 x 78 x 16	150	47	8.66	\$631	\$145
BRTBTS1684	12 x 84 x 16	150	50	9.33	\$675	\$158

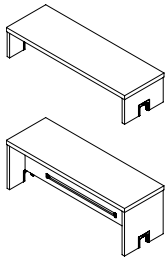

Shared Elevated Table Shelf

Rests on back-to-back Bridges tables. Cut outs in both supporting side gables allow placement over above worksurface power/data troughs. Integrated anodized aluminum accessory rail. White cut out and accessory rail trims. Three heights available. 8" h provides additional storage space without obstructing view; reaches 16" module height when combined w/8" h Binder shelf. Internal height: 6.6". 16" h lines up with top of 16" table dividers (15.8"). Specify 12" narrower shared elevated shelf immediately adjacent to the perpendicular elevated shelf. Internal height: 14.6". Optional Elevated Shelf Binder Bin (BRTESBBIN) rests on top surface for enhanced privacy. 1" top.

- Please refer to the **Compatibility Guide** on page 406 to determine available accessories

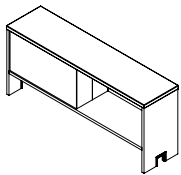

Table Supported Shared Overhead

BRTBAS048	12 x 48 x 21	125	54	7	\$574	\$87
-----------	--------------	-----	----	---	--------------	-------------

One compartment per side. White magnetic back wall. Lines up with 50" h floor standing storage. Fits over the gap between two parallel back-to-back Bridges tables. Fits over worksurface power/data trough. Storage compartment internal height: 12.8". Optional Elevated Shelf Binder Bin (BRTESBBIN) rests on top surface for enhanced privacy. 1" top.

- Please refer to the **Compatibility Guide** on page 406 to determine available accessories

Required Specifications

Top finish
Edge finish
Chassis/Accent Finish

Optional Specifications

HP laminate (tops only)
Elevated Shelf Binder Bin

STORAGE

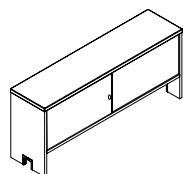

Shared Elevated Overhead*

MODEL#	DIMENSIONS D x W x H	FREIGHT CLASS	WT/LBS.	CUBIC FT.	LIST PRICE	HP ADD
BRTBASL36	16 x 36 x 21	250	23.50	6.56	\$1661	\$110
BRTBASL42	16 x 42 x 21	250	27.50	7.65	\$1778	\$134
BRTBASL48	16 x 48 x 21	250	31.40	8.75	\$1870	\$159
BRTBASL54	16 x 54 x 21	250	35.30	9.84	\$2012	\$167
BRTBASL60	16 x 60 x 21	250	35.30	9.84	\$2122	\$175
BRTBASL66	16 x 66 x 21	250	43.20	12.03	\$2395	\$201
BRTBASL72	16 x 72 x 21	250	47.10	13.12	\$2521	\$226
BRTBASL78	16 x 78 x 21	250	51	14.21	\$2654	\$243
BRTBASL84	16 x 84 x 21	250	55	15.31	\$2688	\$334

Two compartments facing in opposite direction can be locked with sliding glass doors. Storage compartment internal height: 12.25". Shared elevated overhead fits over the gap between two parallel Bridges back-to-back tables. Integrated anodized aluminum accessory rail below the storage compartments. Fits over Above Worksurface Power/Data Troughs. Elevated Shelf Binder Bins DO NOT work with this overhead. 1" top.

- Note: In order to prevent duplex outlet and worksurface access door interference, please specify Overhead of the same width as the supporting worksurface.
- To prevent interference with Ceiling feed pole, please specify Overhead 6" shorter in width corresponding with the length of the supporting worksurface.
- Please refer to the **Compatibility Guide** on page 406 to determine available accessories

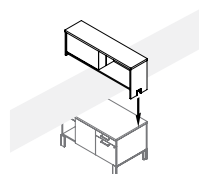

45" High Shared Storage Divider

BRTSDS48	12 x 48 x 16	92.5	54	5.33	\$460	\$87
----------	--------------	------	----	------	--------------	-------------

Divides side-to-side workstations. Two shared, open shelves. One compartment per side. White magnetic back wall. Rests on top of shared 25" box/file/open and back-to-back worksurface. Top of unit is 15.7" from the top of the worksurface. Storage compartment internal height: 12.8". Optional Elevated Shelf Binder Bin (BRTESSBIN) rests on top surface for enhanced privacy. 1" top, white powder-coated steel central partition and backs.

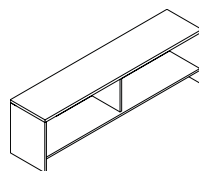

Open Single Sided Storage

BRT21HO3616	16 x 36 x 21	100	81	9	\$827	\$110
BRT21HO4216	16 x 42 x 21	100	81	9	\$888	\$127
BRT21HO4816	16 x 48 x 21	250	31.40	8.75	\$947	\$144
BRT21HO5416	16 x 54 x 21	250	35.30	9.84	\$1005	\$162
BRT21HO6016	16 x 60 x 21	250	35.30	9.84	\$1072	\$181
BRT21HO6616	16 x 66 x 21	250	43.20	12.03	\$1140	\$199
BRT21HO7216	16 x 72 x 21	250	47.10	13.12	\$1182	\$225
BRT21HO7816	16 x 78 x 21	250	51	14.21	\$1272	\$234
BRT21HO8416	16 x 84 x 21	250	55	15.31	\$1323	\$252

Table supported single sided open storage. Storage compartment internal height: 14". 1" top.

- Cannot be used in conjunction with above worksurface power trough.
- To prevent duplex outlet and worksurface access door interference, please specify Overhead of the same width of the supporting worksurface.
- To prevent interference with ceiling feed pole, please specify Overhead 6" shorter in width corresponding with the length of the supporting worksurface.
- Please refer to the **Compatibility Guide** on page 406 to determine available accessories

Required Specifications

Top finish
Edge finish
Chassis finish*
Drawer/door front finish*

Optional Specifications

HP laminate (tops only)
Elevated Shelf Binder Bin (shared storage)

STORAGE

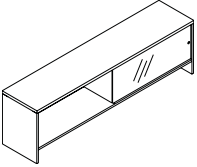

**Open Single Sided Storage,
1 Glass Door**

MODEL#	DIMENSIONS D x W x H	FREIGHT CLASS	WT./LBS.	CUBIC FT.	LIST PRICE	HP ADD
BRT21GS3616	16 x 36 x 21	100	87	9	\$1301	\$109
BRT21GS4216	16 x 42 x 21	100	103	10.50	\$1367	\$126
BRT21GS4816	16 x 48 x 21	100	108	12	\$1426	\$144
BRT21GS5416	16 x 54 x 21	100	133	13.50	\$1701	\$162
BRT21GS6016	16 x 60 x 21	100	144	15	\$1767	\$181
BRT21GS6616	16 x 66 x 21	100	155	16.50	\$1852	\$199
BRT21GS7216	16 x 72 x 21	100	164	18	\$1914	\$216
BRT21GS7816	16 x 78 x 21	100	174	19.50	\$2016	\$233
BRT21GS8416	16 x 84 x 21	100	181	21	\$2075	\$253

Table supported single sided open storage with single sliding glass door with recessed pull. Storage compartment internal height: 14". 1" top.

- Cannot be used in conjunction with above worksurface power trough.
- To prevent duplex outlet and worksurface access door interference, please specify Overhead of the same width of the supporting worksurface.
- To prevent interference with ceiling feed pole, please specify Overhead 6" shorter in width corresponding with the length of the supporting worksurface.
- Please refer to the **Compatibility Guide** on page 406 to determine available accessories

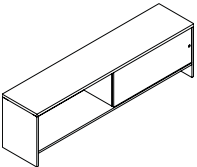

**Open Single Sided Storage,
1 Laminate Door***

BRT21LS3616	16 x 36 x 21	92.5	94	9	\$1263	\$155
BRT21LS4216	16 x 42 x 21	92.5	111	10.50	\$1325	\$179
BRT21LS4816	16 x 48 x 21	100	117	12	\$1383	\$204
BRT21LS5416	16 x 54 x 21	92.5	143	13.50	\$1441	\$231
BRT21LS6016	16 x 60 x 21	92.5	155	15	\$1669	\$254
BRT21LS6616	16 x 66 x 21	92.5	167	16.50	\$1738	\$279
BRT21LS7216	16 x 72 x 21	100	177	18	\$1787	\$306
BRT21LS7816	16 x 78 x 21	100	188	19.50	\$1868	\$331
BRT21LS8416	16 x 84 x 21	100	198	21	\$1919	\$356

Table supported single sided open storage with single sliding laminate door with recessed pull. Storage compartment internal height: 14". 1" top.

- Cannot be used in conjunction with above worksurface power trough.
- To prevent duplex outlet and worksurface access door interference, please specify Overhead of the same width of the supporting worksurface.
- To prevent interference with ceiling feed pole, please specify Overhead 6" shorter in width corresponding with the length of the supporting worksurface.
- Please refer to the **Compatibility Guide** on page 406 to determine available accessories

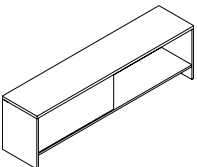

Open Double Sided Storage*

BRT21HDO3616	16 x 36 x 21	100	81	9	\$857	\$109
BRT21HDO4216	16 x 42 x 21	100	96	10.50	\$906	\$127
BRT21HDO4816	16 x 48 x 21	100	100	12	\$948	\$146
BRT21HDO5416	16 x 54 x 21	100	124	13.50	\$1021	\$163
BRT21HDO6016	16 x 60 x 21	100	134	15	\$1075	\$180
BRT21HDO6616	16 x 66 x 21	100	144	16.50	\$1156	\$198
BRT21HDO7216	16 x 72 x 21	100	152	18	\$1193	\$216
BRT21HDO7816	16 x 78 x 21	100	161	19.50	\$1288	\$234
BRT21HDO8416	16 x 84 x 21	100	168	21	\$1324	\$253

Table supported double sided open storage. Fits over the gap between two parallel Bridges II back-to-back tables. Storage compartment internal height: 14". 1" top.

- Cannot be used in conjunction with above worksurface power trough.
- To prevent duplex outlet and worksurface access door interference, please specify Overhead of the same width of the supporting worksurface.
- To prevent interference with ceiling feed pole, please specify Overhead 6" shorter in width corresponding with the length of the supporting worksurface.
- Please refer to the **Compatibility Guide** on page 406 to determine available accessories

Required Specifications

Top finish
Edge finish
Chassis finish*
Drawer/door front finish*

Optional Specifications

HP laminate (tops only)
Elevated Shelf Binder Bin

STORAGE

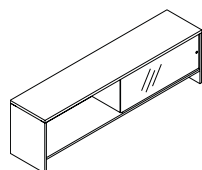

Double Sided Storage, Glass Door

MODEL#	DIMENSIONS	FREIGHT CLASS	WT/LBS.	CUBIC FT.	LIST PRICE	HP ADD
BRT21GDS3616	16 x 36 x 21	92.5	94	9	\$1690	\$105
BRT21GDS4216	16 x 42 x 21	92.5	111	10.50	\$1769	\$127
BRT21GDS4816	16 x 48 x 21	100	117	12	\$1808	\$145
BRT21GDS5416	16 x 54 x 21	92.5	143	13.50	\$2340	\$162
BRT21GDS6016	16 x 60 x 21	92.5	155	15	\$2381	\$181
BRT21GDS6616	16 x 66 x 21	92.5	167	16.50	\$2539	\$198
BRT21GDS7216	16 x 72 x 21	100	177	18	\$2595	\$216
BRT21GDS7816	16 x 78 x 21	100	188	19.50	\$2702	\$233
BRT21GDS8416	16 x 84 x 21	100	196	21	\$2876	\$252

Table supported double sided open storage with sliding glass doors and recessed pull. Fits over the gap between two parallel Bridges II back-to-back tables. Storage compartment internal height: 14". 1" top.

- Cannot be used in conjunction with above worksurface power trough.
- To prevent duplex outlet and worksurface access door interference, please specify Overhead of the same width of the supporting worksurface.
- To prevent interference with ceiling feed pole, please specify Overhead 6" shorter in width corresponding with the length of the supporting worksurface.
- Please refer to the **Compatibility Guide** on page 406 to determine available accessories

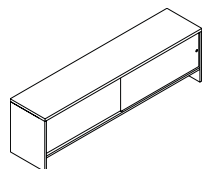

Double Sided Storage, Laminate Door*

BRT21LDS3616	16 x 36 x 21	92.5	106	9	\$1660	\$109
BRT21LDS4216	16 x 42 x 21	85	126	10.50	\$1765	\$127
BRT21LDS4816	16 x 48 x 21	92.5	134	12	\$1802	\$144
BRT21LDS5416	16 x 54 x 21	85	162	13.50	\$2251	\$162
BRT21LDS6016	16 x 60 x 21	92.5	176	15	\$2290	\$181
BRT21LDS6616	16 x 66 x 21	92.5	190	16.50	\$2444	\$199
BRT21LDS7216	16 x 72 x 21	92.5	203	18	\$2481	\$216
BRT21LDS7816	16 x 78 x 21	92.5	216	19.50	\$2573	\$233
BRT21LDS8416	16 x 84 x 21	92.5	227	21	\$2728	\$252

Table supported double sided open storage with sliding laminate doors and recessed pull. Fits over the gap between two parallel Bridges II back-to-back tables. Storage compartment internal height: 14". 1" top.

- Cannot be used in conjunction with above worksurface power trough.
- To prevent duplex outlet and worksurface access door interference, please specify Overhead of the same width of the supporting worksurface.
- To prevent interference with ceiling feed pole, please specify Overhead 6" shorter in width corresponding with the length of the supporting worksurface.
- Please refer to the **Compatibility Guide** on page 406 to determine available accessories

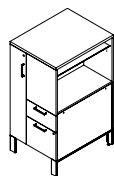

50" H Storage Tower w/Coat Storage*

BRTTW5024L	24 x 24 x 50	100	142	16.66	\$1563	\$102
BRTTW5024R	24 x 24 x 50	100	142	16.66	\$1563	\$102
BRTTW5030L	30 x 24 x 50	125	163	20.83	\$1734	\$102
BRTTW5030R	30 x 24 x 50	125	163	20.83	\$1734	\$102

Provides storage and privacy at the end of a table. Box/File drawers, open compartment with adjustable shelf (50"h); coat storage with hinged door. Specify Left or Right handed. Capable of supporting worksurface on one side. Built-in threaded inserts to secure dedicated worksurface supporting beam. Open side storage compartment internal height: 19.6". Optional cable basket suspends off storage unit's bottom and manages cables along the horizontal plane. 1" top; metal handles; powder-coated aluminum or anodized aluminum legs. Black pencil tray included.

- Anodized Aluminum Leg - Add \$61 list upcharge

Required Specifications

Top finish
Edge finish
Chassis finish*
Drawer/door front finish*

Optional Specifications

HP laminate (tops only)
Elevated Shelf Binder Bin

STORAGE

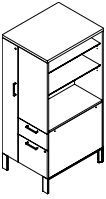

66" H Storage Tower with Coat Storage

MODEL#	DIMENSIONS D x W x H	FREIGHT CLASS	WT/LBS.	CUBIC FT.	LIST PRICE	HP ADD
BRTTW6624L	24 x 24 x 66	125	170	22	\$2072	\$132
BRTTW6624R	24 x 24 x 66	125	170	22	\$2072	\$132
BRTTW6630L	30 x 24 x 66	125	195	27.50	\$2298	\$133
BRTTW6630R	30 x 24 x 66	125	195	27.50	\$2298	\$161

Provides storage and privacy at the end of a table. Box/File drawers, open compartment with 2 adjustable shelves (66" h); coat storage with hinged door and 2 shelves. Specify Left or Right handed. Capable of supporting worksurface on one side. Built-in threaded inserts to secure dedicated worksurface supporting beam. Open side storage compartment internal height: 35.6". Optional cable basket suspends off storage unit's bottom and manages cables along the horizontal plane. 1" top; metal handles; powder-coated aluminum or anodized aluminum legs. Black pencil tray included.

- Anodized Aluminum Leg - Add **\$61** list upcharge

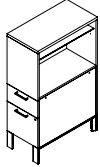

50" H Storage Tower

BRTT5024L	24 x 15.5 x 50	100	88	10.76	\$1161	\$74
BRTT5024R	24 x 15.5 x 50	100	88	10.76	\$1161	\$74
BRTT5030L	30 x 15.5 x 50	125	101	13.45	\$1277	\$87
BRTT5030R	30 x 15.5 x 50	125	101	13.45	\$1277	\$87

Provides storage and privacy at the end of a table. Box/File drawers, open compartment with adjustable shelf (50" h). Specify Left or Right handed. Capable of supporting worksurface on one side. Built-in threaded inserts to secure dedicated worksurface supporting beam. Open side storage compartment internal height: 19.6". Optional cable basket suspends off storage unit's bottom and manages cables along the horizontal plane. 1" top; metal handles; powder-coated aluminum or anodized aluminum legs. Black pencil tray included.

- Anodized Aluminum Leg - Add **\$61** list upcharge

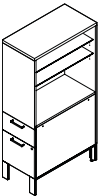

66" H Storage Tower

BRTT6624L	24 x 15.5 x 66	100	106	12.91	\$1539	\$95
BRTT6624R	24 x 15.5 x 66	100	106	12.91	\$1539	\$95
BRTT6630L	30 x 15.5 x 66	125	121	16.14	\$1692	\$115
BRTT6630R	30 x 15.5 x 66	125	121	16.14	\$1692	\$115

Provides storage and privacy at the end of a table. Box/File drawers, open compartment with 2 adjustable glass shelves (66" h). Specify Left or Right handed. Capable of supporting worksurface on one side. Built-in threaded inserts to secure dedicated worksurface supporting beam. Open side storage compartment internal height: 35.6". Optional cable basket suspends off storage unit's bottom and manages cables along the horizontal plane. 1" top; metal handles; powder-coated aluminum or anodized aluminum legs. Black pencil tray included.

- Anodized Aluminum Leg - Add **\$61** list upcharge



Cantilever Storage*

BRTCS45BBFFL	18 x 36 x 45	92.5	256	24	\$2111	\$109
BRTCS45BBFFR	18 x 36 x 45	92.5	256	24	\$2111	\$109

Provides storage and privacy anywhere along the length of the bench. The middle opening of the cabinet allows the upper portion to cantilever above the worksurface. 2 locking file drawers. 2 pencil drawers (not locking). Open compartment with adjustable glass shelf, internal dimension of 15.9". Three fixed open compartments; two above worksurfaces (6.7" interior dimension), one below (3.7" interior dimension). Specify Left or Right handed. Optional cable basket suspends off storage unit's bottom and manages cables along the horizontal plane. 1" top; metal handles; powder-coated aluminum or anodized aluminum legs.

- Anodized Aluminum Leg - Add **\$61** list upcharge

Required Specifications

Top finish
Chassis finish
Drawer/door front finish
Metal finish (legs)

Edge finish

Optional Specifications

Anodized aluminum leg
HP laminate
E-Lock*

STORAGE



Cantilever Storage*

MODEL#	DIMENSIONS D x W x H	FREIGHT CLASS	WT/LBS.	CUBIC FT.	LIST PRICE	HP ADD
BRTCS45FFFOL	18 x 36 x 45	92.5	256	24	\$2163	\$109
BRTCS45FFFOR	18 x 36 x 45	92.5	256	24	\$2163	\$109

Provides storage and privacy anywhere along the length of the bench. The middle opening of the cabinet allows the upper portion to cantilever above the worksurface. 3 locking file drawers with 2 locks. Open compartment (10.3" interior dimension). Three fixed open compartments; two above worksurfaces (6.7" interior dimension), one below (3.7" interior dimension). Specify Left or Right handed. Optional cable basket suspends off storage unit's bottom and manages cables along the horizontal plane. 1" top; metal handles; powder-coated aluminum or anodized aluminum legs.

- Anodized Aluminum Leg - Add **\$61** list upcharge

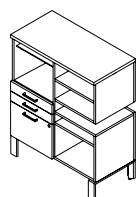

Cantilever Storage*

BRTCS45BBFOOL	18 x 36 x 45	92.5	256	24	\$2066	\$109
BRTCS45BBFOR	18 x 36 x 45	92.5	256	24	\$2066	\$109

Provides storage and privacy anywhere along the length of the bench. The middle opening of the cabinet allows the upper portion to cantilever above the worksurface. Locking file drawer. 2 pencil drawers (not locking). Open compartment (10.3" interior dimension) with adjustable glass shelf. 4 fixed open compartments; two above worksurfaces (6.7" interior dimension), two below (lower 12.2" interior dimension; upper 3.3" interior dimension). Specify Left or Right handed. Optional cable basket suspends off storage unit's bottom and manages cables along the horizontal plane. 1" top; metal handles; powder-coated aluminum or anodized aluminum legs.

- Anodized Aluminum Leg - Add **\$61** list upcharge



Pier Storage, Box/File

BRTDS2B2F	16 x 18 x 36	125	85	14	\$1292	n/a
-----------	--------------	-----	----	----	---------------	-----

Supports side-by-side divider with Box/File on opposite sides for side-by-side application. Two lockable file drawers, two box drawers. Black pencil tray included.

- Optional e-lock available in the vertical position. Please specify V-Vertical and add xxx list each.

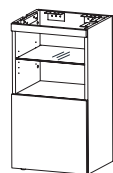

Pier Storage, Open w/Glass Shelves

BRTDSOP	16 x 18 x 36	150	75	14	\$860	n/a
---------	--------------	-----	----	----	--------------	-----

Supports side-by-side divider with Box/File on opposite sides for side-by-side application. Storage compartment internal height without adjustable shelf: 15"

Required Specifications

Top finish*
Edge finish
Chassis finish
Drawer/door front finish

Optional Specifications

Anodized aluminum leg*
E-Lock*
HP laminate*

STORAGE

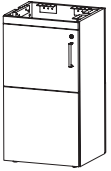

Pier Storage, Door w/Glass Shelves

MODEL#	DIMENSIONS D x W x H	FREIGHT CLASS	WT./LBS.	CUBIC FT.	LIST PRICE	HP ADD
BRTDS2D	16 x 18 x 36	150	79	14	\$1155	n/a

Supports side-by-side divider with hinged, lockable door on opposite sides for side-by-side application. Storage compartment internal height without adjustable shelf: 15"

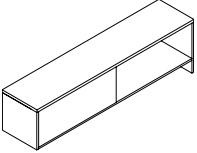

Side-by-Side Storage, Open*

BRT21PHDO4216	16 x 42 x 21	100	96	10.50	\$747	\$127
BRT21PHDO4816	16 x 48 x 21	100	100	12	\$795	\$146
BRT21PHDO5416	16 x 54 x 21	100	124	13.50	\$872	\$162
BRT21PHDO6016	16 x 60 x 21	100	134	15	\$920	\$181
BRT21PHDO6616	16 x 66 x 21	100	144	16.50	\$999	\$197
BRT21PHDO7216	16 x 72 x 21	100	152	18	\$1052	\$216

Pier and table supported side-by-side double-sided open storage. Divides space and provides storage anywhere along bench or table. Storage compartment internal height: 14". 1" top.

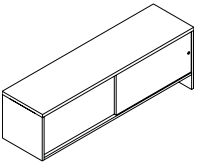

Side-by-Side Storage, Laminate Doors*

BRT21PLDS4216	16 x 42 x 21	92.5	126	11	\$1733	\$127
BRT21PLDS4816	16 x 48 x 21	92.5	134	12	\$1770	\$145
BRT21PLDS5416	16 x 54 x 21	92.5	162	14	\$2220	\$162
BRT21PLDS6016	16 x 60 x 21	92.5	176	15	\$2259	\$181
BRT21PLDS6616	16 x 66 x 21	92.5	190	17	\$2413	\$199
BRT21PLDS7216	16 x 72 x 21	92.5	203	18	\$2450	\$216

Pier and table supported side-by-side double-sided storage with sliding laminate doors and recessed pull. Divides space and provides storage anywhere along bench or table. Storage compartment internal height: 14". 1" top.

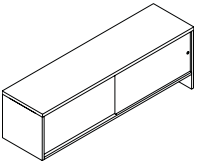

Side-by-Side Storage, Glass Doors

BRT21PGDS4216	16 x 42 x 21	92.5	110	10.50	\$1750	\$125
BRT21PGDS4816	16 x 48 x 21	100	116	12	\$1789	\$144
BRT21PGDS5416	16 x 54 x 21	92.5	141	13.50	\$2321	\$162
BRT21PGDS6016	16 x 60 x 21	92.5	153	15	\$2362	\$180
BRT21PGDS6616	16 x 66 x 21	92.5	165	16.50	\$2520	\$198
BRT21PGDS7216	16 x 72 x 21	100	175	18	\$2577	\$217

Pier and table supported side-by-side double-sided storage with sliding glass doors and recessed pull. Divides space and provides storage anywhere along bench or table. Storage compartment internal height: 14". 1" top.

Required Specifications

Top finish*
Edge finish*
Chassis finish
Drawer/door front finish

Optional Specifications

Anodized aluminum leg

ACCESSORIES

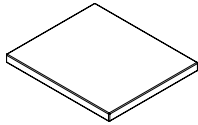

Cushion

MODEL#	DIMENSIONS	FREIGHT CLASS	WT/LBS.	CUBIC FT.	GRADE	LIST	GRADE	LIST
BRTC	18 x 15.5 x 1.25	150	2	.41	1	\$186	7	\$359
						\$211	8	\$389
						\$231	9	\$423
						\$255	10	\$459
						\$290	11	\$505
						\$325	12	\$573

Optional seat cushion may be added to any storage component. Available in all Global seating fabrics.

- When added to 25" h storage units, unit will NOT fit under any table with a beam

ACCESSORIES

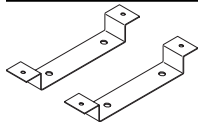

Glide Tray Adapter

MODEL#	DIMENSIONS	FREIGHT CLASS	WT/LBS.	CUBIC FT.	LIST PRICE	HP ADD
GAGTA01	2 x 9 x 2.5	70	.50	.03	\$84	

Accommodates the placement of sliding keyboard mechanisms and CPU holders below the cross beam of Bridges tables. Attaches to Glide Tracks of all Productivity Solutions Keyboard Mechanisms and Sliding CPU holders. Mounting hardware included. Available in black only.

- Cannot be used with GACPU01. See Productivity Solutions for compatible keyboard mechanisms and sliding CPU holder.

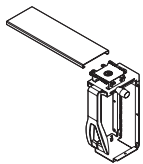

CPU Holder on Glide Track

GACPU02	9.2 x 11.7 x 18.5	92.5	12.60	1.15	\$185	
---------	-------------------	------	-------	------	--------------	--

Accepts tower CPUs with a width range of 12.5" to 22.5" and width range of 3.5" to 9.3". Soft touch knob for side clamp adjustment and bayonet lance for vertical height adjustment. 12" glide track mounted and 360° swivel for easy access to rear of CPU. Manufactured from steel and engineered resin, providing rugged durability and support. Available in black only.

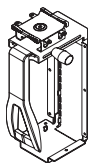

Fixed Mount CPU Holder

GACPU01	9.2 x 11.7 x 18.5	125	9	1.15	\$167	
---------	-------------------	-----	---	------	--------------	--

Fully adjustable clamping mechanism to accept tower CPUs with a height range of 12.5" to 22.5" and width range of 3.5" to 9.3". Soft touch knob for side clamp adjustment and bayonet lance for vertical height adjustment. Mounts directly to underside of desk surface. CPU Holder can also be mounted directly to an upright desk leg surface or wall via side mounting holes. Manufactured from Steel and Engineered Resin, providing rugged durability and support. Available in black only.

- Not compatible with GAGTA01

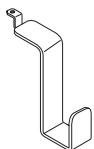

Hanging Bracket

BRTHB	3.3 x 1.5 x 3.5	70	.20	.01	\$22	
-------	-----------------	----	-----	-----	-------------	--

A formed steel bracket hooks over Bridges II table leg. Can be secured either on the inner or outer side of the leg. Specify frame finish.

Required Specifications

Fabric (Cushion)

Metal Finish (hanging bracket)

ACCESSORIES

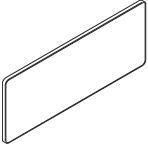

Whiteboard

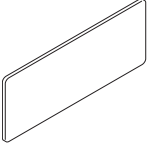

Tackboard

MODEL#	DIMENSIONS D x W x H	FREIGHT CLASS	WT/LBS.	CUBIC FT.	LIST PRICE
BRTWB0924	0.5 x 24 x 8.5	70	1	.56	\$186

White dry-erase marker board surface on white powder coated steel backer. Fits 16" tall Bridges II dividers and single-sided shelves. White dry-erase surface attaches magnetically to the steel backer. When removed, the steel backer can be used as a magnetic board. *Please refer to the **Compatibility Guide** (page 406) to determine available accessories.*

- Available in Tungsten (TUN) or Designer White (DWT) Only

BRTTB0924	0.5 x 24 x 8.5	70	1	.56	\$186
-----------	----------------	----	---	-----	--------------

Grey tackboard surface on white powder coated steel backer. Fits 16" tall Bridges II dividers and single-sided shelves. *Please refer to the **Compatibility Guide** (page 406) to determine available accessories.*

- Available in Tungsten (TUN) or Designer White (DWT) Only

Required Specifications

Metal finish
Fabric (tackboard)

MONITOR ARMS

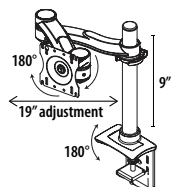
**Single Screen Double Extension Arm**

MODEL#	DIMENSIONS	FREIGHT CLASS	WT/LBS.	CUBIC FT.	LIST PRICE
GAMCSSDE	-- x -- x --	125	7.50	1.09	\$420

D x W x H

Double extension allows 19" of horizontal back and forth movement. Arm folds back to post for more desk space. Displays are able to tilt 180°, swing 180° side-to-side and rotate from landscape to portrait. Minor assembly required.

- Short clamp allows arm to be clamped on rear worksurface edge in conjunction with BRTEETxxxDKIT power troughs

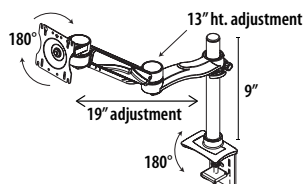
**Single Screen Double Extension Arm with Height Adjustment**

GAMCSSDEH	-- x -- x --	125	8.20	1.09	\$504
-----------	--------------	-----	------	------	--------------

Counterbalanced arm provides an additional 13" of height adjustment. Double extension allows 19" of horizontal back and forth movement. Easy to use Allen wrench allows user to adjust the counterbalance mechanism for easy movement of the monitor. Displays are able to tilt 180°, swing 180° side-to-side and rotate from landscape to portrait. Cable manager comes on extension arm and hides all cables. Minor assembly required.

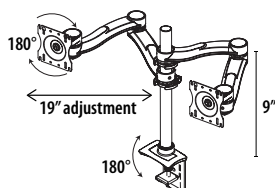
**Dual Screen Double Extension Arm**

GAMCDSDE	-- x -- x --	100	10.70	1.09	\$742
----------	--------------	-----	-------	------	--------------

For dual monitor applications. Double extension arms allow 19" of horizontal back and forth movement. Easy to use Allen wrench allows user to adjust the counterbalance mechanism for easy movement of the monitor. Displays are able to tilt 180°, swing 180° side-to-side and rotate from landscape to portrait. Minor assembly required.

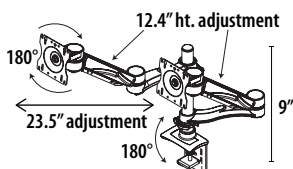
**Dual Screen Double Extension Arm with Height Adjustment**

GAMCDSDEH	-- x -- x --	92.5	12.2	1.09	\$936
-----------	--------------	------	------	------	--------------

For dual monitor applications. Counterbalanced arms provide an additional 13" of height adjustment. Double extension arms allow 19" of horizontal back and forth movement. Easy to use Allen wrench allows user to adjust the counterbalance mechanism for easy movement of the monitor. Displays are able to tilt 180°, swing 180° side-to-side and rotate from landscape to portrait. Cable manager comes on extension arm and hides all cables. Minor assembly required.

ACCESSORIES

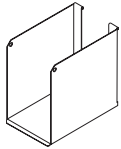

Binder Bin

MODEL#	DIMENSIONS D x W x H	FREIGHT CLASS	WT./LBS.	CUBIC FT.	LIST PRICE
BABB01	10.25 x 4 x 9	100	2	.21	\$50

Load bar/accessory rail mounted metal binder bin.
 • Please refer to the **Compatibility Guide** on page 406 to determine compatible storage components

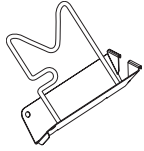

Flip Sorter

BAFS01	9.25 x 2.75 x 9.25	70	.06	.14	\$38
--------	--------------------	----	-----	-----	-------------

Load bar/accessory rail mounted metal flip sorter. Comes with chrome wire.
 • Please refer to the **Compatibility Guide** on page 406 to determine compatible storage components

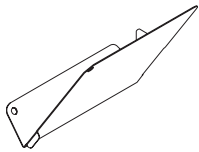

Slant Sorter

BASS01L (Left)	10.25 x 5 x 9.5	70	1	.28	\$31
BASS01R (Right)	10.25 x 5 x 9.5	70	1	.28	\$31

Load bar/accessory rail mounted metal slant sorter.
 • Please refer to the **Compatibility Guide** on page 406 to determine compatible storage components

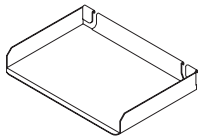

Letter/Legal Tray

BALTO1 (Letter)	9.25 x 13.5 x 2	70	.05	.15	\$41
BALTO1LGL (Legal)	9.25 x 15 x 2	70	.05	.15	\$54

Load bar/accessory rail mounted metal letter or legal tray.
 • Please refer to the **Compatibility Guide** on page 406 to determine compatible storage components

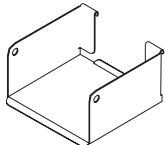

Media Bin

BAMB01	5.25 x 5.75 x 3	70	.08	.05	\$41
--------	-----------------	----	-----	-----	-------------

Load bar/accessory rail mounted metal media bin.
 • Please refer to the **Compatibility Guide** on page 406 to determine compatible storage components

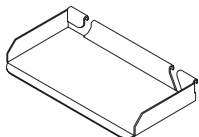

Utility Tray

BAUT01	3.75 x 5.75 x 3	70	.05	.02	\$27
--------	-----------------	----	-----	-----	-------------

Load bar/accessory rail mounted metal utility tray.
 • Please refer to the **Compatibility Guide** on page 406 to determine compatible storage components

Required Specifications

Fabric (Cushion)
 Metal Finish (hanging bracket, whiteboard, tackboard)

ACCESSORIES

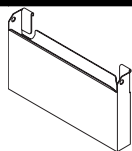
**Mail Box**

MODEL#	DIMENSIONS	FREIGHT CLASS	WT/LBS.	CUBIC FT.	LIST PRICE
--------	------------	---------------	---------	-----------	------------

	D x W x H				
BAPP01	2.75 x 16 x 9	100	2	.25	\$64

Load bar/accessory rail mounted metal mail box.

- Please refer to the **Compatibility Guide** on page 406 to determine compatible storage components

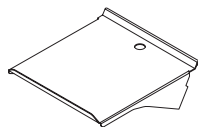
**Telephone Holder**

BATH01	10 x 9 x 2	125	2	.26	\$61
--------	------------	-----	---	-----	-------------

Load bar/accessory rail mounted metal telephone holder.

- Please refer to the **Compatibility Guide** on page 406 to determine compatible storage components

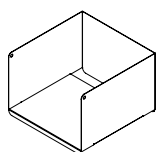
**Elevated Shelf Binder Bin**

BRTESBBIN	12 x 12 x 8	100	6	.66	\$132
-----------	-------------	-----	---	-----	--------------

Load bar/accessory rail mounted elevated shelf binder bin.

- Please refer to the **Compatibility Guide** on page 406 to determine compatible storage components

ACCESSORIES

D x W x H

ACCESSORIES COMPATIBILITY GUIDE

	DIVIDERS: BRTLPPD BRTLPS BR2AFD BR2AHD	Elevated Shelves BRTSTS08 BRTBTS08 8" high	Elevated Shelves BRTSTS13 BRTBTS13 13" high	Elevated Shelves BRTSTS16 BRTBTS16 16" high	Shared Overhead BRTBAS048 12" deep	Shared Overhead with slid- ing doors BRTBASS 16" deep
Binder Bin BABB01	yes	no	no	yes	no	no
Flip Sorter BAFS01	yes	no	yes	no	no	no
Slant Sorter BASS01	yes	no	yes	no	no	no
Letter Tray BALT01	yes	yes	yes	yes	yes	yes
Media Bin BAMB01	yes	yes	yes	yes	yes	yes
Utility Tray BAUT01	yes	yes	yes	yes	yes	yes
Mail Box BAPP01	yes	no	no	yes	no	no
Phone Holder BVATH01	yes	yes	yes	yes	yes	yes
Elevated Shelf Binder Bin BRTEBBIN	no	no	no	no	yes	no
Tackboard BRTTB	yes	no	no	yes	no	no
Whiteboard BRTWB	yes	no	no	yes	no	no

COLLABORATIVE SEATING**D x W x H**

Bridges collaborative seating collection consists of seating, privacy screens, tables, tablets and power. It is a versatile modular furniture series which can be configured into many space planning scenarios, including corner, in-line, open concept, traditional reception, as well as secluded seating with high privacy partitions.

Furniture pieces can be used as stand alone items or can be mechanically linked together to form a variety of seating configurations.

Seat and backrest can be integrated with Bridges tables.

Corner tables and in-line 6" table modules double as power delivery centers.

Dedicated seat backrests feature dual USB charging port.

Some inline 6" table modules are furnished with grommets to support tablets.

Legs are available in standard Bridges metal painted finishes and anodized aluminum finish.

Bridges Collaborative Seating upholstery features a single stitch, thick white thread around the edges. The white, wide stitch along with crisp corners are part of its distinctive personality. In order to achieve crisp edges and to minimize "pillow" effect caused by taut fabric, the upholstery material has been applied deliberately loose, which may over time, produce puckering of the upholstery surface material. This can be easily corrected by stretching the fabric by hand or during vacuuming.

In order to efficiently utilize fabric yield, all 60" seats and backs feature a seam in the middle. The double stitch seam is sewn with a thin thread, closely matching the upholstery material in color.

Some complicated fabric patterns prevent pattern matching and will be upholstered without the seam at the discretion of the factory.

Should you require no middle seam by cutting into the roll, please specify "NO SEAM" at time of your order.

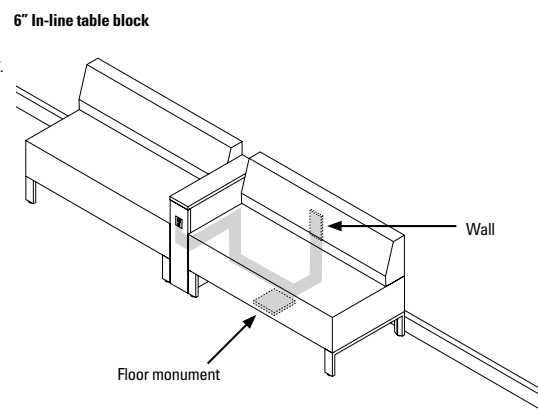
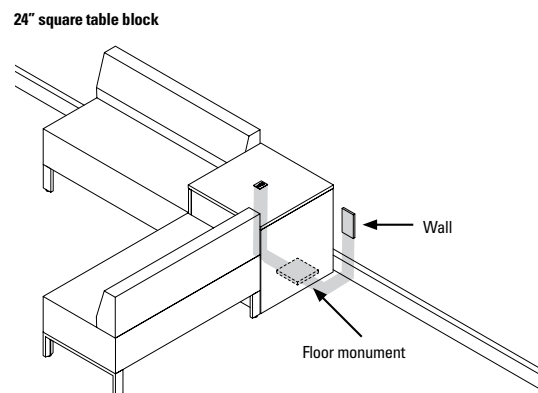
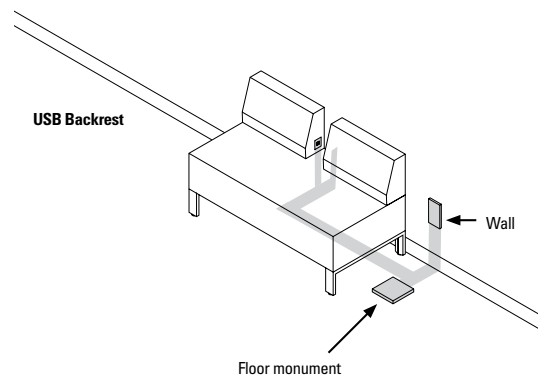

COLLABORATIVE SEATING

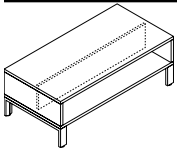

Low Table*

MODEL#	DIMENSIONS D x W x H	FREIGHT CLASS	WT/LBS.	CUBIC FT.	LIST PRICE	HP ADD
BRTST2460F	24 x 60 x 17	150	83.60	14.17	\$649	\$239
BRTST2448F	24 x 48 x 17	125	69	11.33	\$580	\$173
BRTST2424F	24 x 24 x 17	125	40.70	5.67	\$409	\$71

Freestanding 17”h table. Central partition divides space under top surface into two 11” deep compartments. All LP chassis w/ HP or LP top (3mm edging). Bridges storage aluminum leg.

- Anodized Aluminum Leg - Add **\$54**. list upcharge
- To convert to mobile - Add an **M** at the end of the product code. Add **\$35**. list upcharge.

COLLABORATIVE SEATING

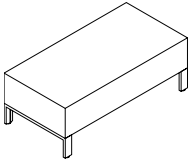

Lounge Seat

					GRADE	LIST	GRADE	LIST
BRTSE60NB	24 x 60 x 17	250	47	14.17	1	\$1224	7	\$1640
					2	\$1284	8	\$1784
					3	\$1331	9	\$1897
					4	\$1401	10	\$2021
					5	\$1502	11	\$2276
					6	\$1549	12	\$2549
BRTSE48NB	24 x 48 x 17	250	36.90	11.33	1	\$1057	7	\$1391
					2	\$1106	8	\$1507
					3	\$1144	9	\$1596
					4	\$1200	10	\$1696
					5	\$1280	11	\$1901
					6	\$1318	12	\$2118
BRTSE24NB	24 x 24 x 17	150	22.70	5.57	1	\$580	7	\$788
					2	\$611	8	\$862
					3	\$635	9	\$918
					4	\$670	10	\$980
					5	\$720	11	\$1107
					6	\$743	12	\$1243

Fully upholstered armless lounge seat with metal base. Seats can be freestanding or linked with optional interlocking bracket kit.

- Anodized Aluminum Leg - Add **\$54** list upcharge

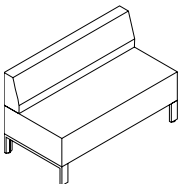

Lounge Seat, Full Backrest

BRTSE6060B	24 x 60 x 29	250	70	24.17	1	\$1956	7	\$2705
					2	\$2064	8	\$2966
					3	\$2149	9	\$3166
					4	\$2276	10	\$3389
					5	\$2456	11	\$3850
					6	\$2540	12	\$4340
BRTSE4848B	24 x 48 x 29	250	55.50	19.33	1	\$1688	7	\$2270
					2	\$1771	8	\$2472
					3	\$1837	9	\$2629
					4	\$1936	10	\$2802
					5	\$2077	11	\$3161
					6	\$2142	12	\$3542
BRTSE2424B	24 x 24 x 29	250	33	9.57	1	\$914	7	\$1289
					2	\$969	8	\$1419
					3	\$1011	9	\$1520
					4	\$1075	10	\$1632
					5	\$1164	11	\$1862
					6	\$1207	12	\$2107

Fully upholstered armless lounge seat with full backrest and metal base. Backrests are permanently secured to the seats and cannot be reconfigured on site. Seats can be freestanding or linked with optional interlocking bracket kit.

- Anodized Aluminum Leg - Add **\$54** list upcharge

Required Specifications

Top finish* Edge finish*
 Chassis finish*
 Fabric
 Metal Finish (legs)

Optional Specifications

Anodized Aluminum Leg
 HP laminate*

COLLABORATIVE SEATING

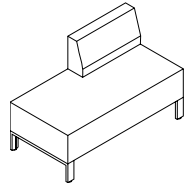

Lounge Seat, 24" Offset Backrest

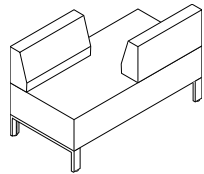

Lounge Seat, Two 24" Offset Backrests

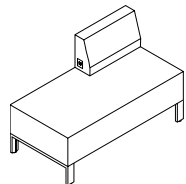

Lounge Seat, 21" USB Backrest

MODEL#	DIMENSIONS	FREIGHT CLASS	WT/LBS.	CUBIC FT.	GRADE	LIST	GRADE	LIST
D x W x H								
BRTSE2448BL	24 x 48 x 29	250	46.10	19.33	1	\$1391	7	\$1892
					2	\$1464	8	\$2065
					3	\$1521	9	\$2199
					4	\$1604	10	\$2347
					5	\$1725	11	\$2654
					6	\$1781	12	\$2981
BRTSE2448BR (shown)	24 x 48 x 29	250	46.10	19.33	1	\$1391	7	\$1892
					2	\$1464	8	\$2065
					3	\$1521	9	\$2199
					4	\$1604	10	\$2347
					5	\$1725	11	\$2654
					6	\$1781	12	\$2981
Fully upholstered armless lounge seat with one backrest and metal base. Specify backrest as either left or right side. Backrests are permanently secured to the bench and cannot be reconfigured on site. Seats can be freestanding or linked with optional interlocking bracket kit.								
• Anodized Aluminum Leg - Add \$54 list upcharge								
BRTSE2448BODL (shown)	24 x 48 x 29	250	46.10	19.33	1	\$1725	7	\$2391
					2	\$1821	8	\$2623
					3	\$1896	9	\$2800
					4	\$2009	10	\$3000
					5	\$2170	11	\$3409
					6	\$2245	12	\$3844
BRTSE2448BODR	24 x 48 x 29	250	46.10	19.33	1	\$1725	7	\$2391
					2	\$1821	8	\$2623
					3	\$1896	9	\$2800
					4	\$2009	10	\$3000
					5	\$2170	11	\$3409
					6	\$2245	12	\$3844
Fully upholstered armless lounge seat with two offset backrests and metal base. Specify either left or right backrest configuration. Backrests are permanently secured to the bench and cannot be reconfigured on site. Seats can be freestanding or linked with optional interlocking bracket kit.								
• Anodized Aluminum Leg - Add \$54 list upcharge								
BRTSE2148EBL	24 x 48 x 29	250	33	9.67	1	\$1612	7	\$2112
					2	\$1685	8	\$2285
					3	\$1741	9	\$2420
					4	\$1826	10	\$2568
					5	\$1946	11	\$2874
					6	\$2003	12	\$3202
BRTSE2148EBR (shown)	24 x 48 x 29	250	46.10	19.33	1	\$1612	7	\$2112
					2	\$1685	8	\$2285
					3	\$1741	9	\$2420
					4	\$1826	10	\$2568
					5	\$1946	11	\$2874
					6	\$2003	12	\$3202
Fully upholstered armless lounge seat with one backrest and metal base. 21" w backrest comes with embedded dual USB port in its side. Note: The side mounted power/USB outlets always point to the center of the seat. Each USB outlet offers 2 amps. AC/DC transformer plugs into the wall or floor monument (approx. 4' long cable available from the bottom of the seat). Transformer power consumption: 0.68 amps. Specify either left or right backrest configuration. Backrests are permanently secured to the bench and cannot be reconfigured on site. Seats can be freestanding or linked with optional interlocking bracket kit. White USB outlets.								
• Anodized Aluminum Leg - Add \$54 list upcharge								

Required SpecificationsFabric
Metal Finish (legs)**Optional Specifications**

Anodized Aluminum Leg

COLLABORATIVE SEATING

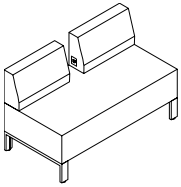

Lounge Seat, Two 21" USB Backrests

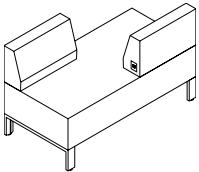

Lounge Seat, Two Offset USB Backrests

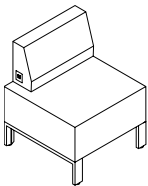

Lounge Seat, 21" USB Backrest

MODEL#	DIMENSIONS D x W x H	FREIGHT CLASS	WT/LBS.	CUBIC FT.	GRADE	LIST	GRADE	LIST
BRTSE2148E2B	24 x 48 x 29	250	57	19.33	1	\$2167	7	\$2832
					2	\$2262	8	\$3064
					3	\$2337	9	\$3242
					4	\$2450	10	\$3440
					5	\$2611	11	\$3849
					6	\$2687	12	\$4285

Fully upholstered armless lounge seat with two backrests and metal base. Both 21" w backrests come with embedded dual USB port in its side. Note: The side mounted power/USB outlets always point to the center of the seat. Each USB outlet offers 2 amps. AC/DC transformer plugs into the wall or floor monument (approx. 52" long cable available from the bottom of the seat). Transformer power consumption: 0.68 amps. Backrests are permanently secured to the bench and cannot be reconfigured on site. Seats can be freestanding or linked with optional interlocking bracket kit. White USB outlets.

- Anodized Aluminum Leg - Add \$54 list upcharge

BRTSE2148EBODL (shown)	24 x 48 x 29	250	57	19.33	1	\$2167	7	\$2832
					2	\$2262	8	\$3064
					3	\$2337	9	\$3242
					4	\$2450	10	\$3440
					5	\$2611	11	\$3849
					6	\$2687	12	\$4285

BRTSE2148EBODR	24 x 48 x 29	250	57	19.33	1	\$2167	7	\$2832
					2	\$2262	8	\$3064
					3	\$2337	9	\$3242
					4	\$2450	10	\$3440
					5	\$2611	11	\$3849
					6	\$2687	12	\$4285

Fully upholstered armless lounge seat with two offset backrests and metal base. Both 21" w backrests come with embedded dual USB port in its side. Note: The side mounted power/USB outlets always point to the center of the seat. Each USB outlet offers 2 amps. AC/DC transformer plugs into the wall or floor monument (approx. 52" long cable available from the bottom of the seat). Transformer power consumption: 0.68 amps. Specify either left or right backrest configuration. Backrests are permanently secured to the bench and cannot be reconfigured on site. Seats can be freestanding or linked with optional interlocking bracket kit. White USB outlets.

- Anodized Aluminum Leg - Add \$54 list upcharge

BRTSE2124EBL	24 x 24 x 29	250	46.10	19.33	1	\$1135	7	\$1510
					2	\$1189	8	\$1640
					3	\$1232	9	\$1740
					4	\$1295	10	\$1852
					5	\$1385	11	\$2082
					6	\$1428	12	\$2327

BRTSE2124EBR (shown)	24 x 24 x 29	250	46.10	19.33	1	\$1135	7	\$1510
					2	\$1189	8	\$1640
					3	\$1232	9	\$1740
					4	\$1295	10	\$1852
					5	\$1385	11	\$2082
					6	\$1428	12	\$2327

Fully upholstered armless lounge seat with one backrest and metal base. 21" w backrest comes with embedded dual USB port in its side. Note: Each USB outlet offers 2 amps. AC/DC transformer plugs into the wall or floor monument (approx. 52" long cable available from the bottom of the seat). Transformer power consumption: 0.68 amps. Specify either left or right. Backrests are permanently secured to the bench and cannot be reconfigured on site. Seats can be freestanding or linked with optional interlocking bracket kit. White USB outlets.

- Anodized Aluminum Leg - Add \$54 list upcharge

Required Specifications

Fabric
Metal Finish (legs)

Optional Specifications

Anodized Aluminum Leg

COLLABORATIVE SEATING

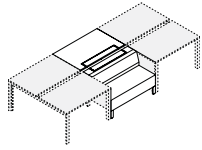

Integrated Lounge Seat, Single-Sided

MODEL#	DIMENSIONS	FREIGHT CLASS	WT./LBS.	CUBIC FT.	GRADE	LIST	GRADE	LIST		
BRTSINT60S	24 x 60 x 29	125	155	24.17						
					D x W x H					
					1	\$3106	7	\$3838		
					2	\$3199	8	\$4100		
					3	\$3282	9	\$4301		
					4	\$3411	10	\$4524		
5	\$3590	11	\$4984							
6	\$3676	12	\$5475							
BRTSINT48S	24 x 48 x 29	100	182	19.33	1	\$2939	7	\$3522		
					2	\$3024	8	\$3725		
					3	\$3089	9	\$3882		
					4	\$3189	10	\$4055		
					5	\$3328	11	\$4413		
					6	\$3394	12	\$4794		

Fully upholstered armless lounge seat with full width backrest and metal legs integrated into Bridges 62.5" d back-to-back linear table assembly. The single-sided kit consists of 24" x 48" or 24" x 60" seat, full width back, three-sided below worksurface enclosure, 6" d worksurface module with access door, 30" x 48" or 30" x 60" w worksurface with access door and supporting hardware. The seat module accommodates continuation of power and data distribution services below worksurfaces (specify Below Worksurface Power Trough and power components separately). The 6" d worksurface module with access door provides access to Below Worksurface Power Trough. Backrests are permanently secured to the bench and cannot be reconfigured on site. Tables not included.

• **Only compatible with back-to-back 30" d worksurfaces (62.5" total depth) supported by Bridges rectangular legs.** Not compatible with round legs, 24" d worksurfaces; not compatible with single line table assemblies 24" and 30" d. The kit cannot be used at the end of a table run, nor can it be used as a standalone, freestanding configuration. It must always be supported by back-to-back table assemblies on either side

- Anodized Aluminum Leg - Add \$54 list upcharge
- High pressure laminate - Add \$195 list upcharge

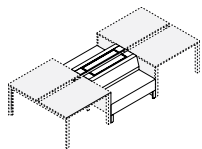

Integrated Lounge Seat, Double-Sided

BRTSINT60D	24 x 60 x 29	125	155	24.17	1	\$5078	7	\$5827
					2	\$5186	8	\$6088
					3	\$5271	9	\$6288
					4	\$5398	10	\$6511
					5	\$5578	11	\$6972
					6	\$5663	12	\$7463
BRTSINT48D	24 x 48 x 29	100	182	19.33	1	\$4542	7	\$5124
					2	\$4625	8	\$5327
					3	\$4691	9	\$5483
					4	\$4790	10	\$5656
					5	\$4931	11	\$6015
					6	\$4997	12	\$6396

Fully upholstered armless lounge bench with full backrests and metal legs integrated into Bridges 62.5" d back-to-back linear table assembly. The double-sided kit consists of two 24" x 48" or 24" x 60" seats, full width backs, three-sided below worksurface enclosures, 6" d worksurface modules with access doors and supporting hardware. The seat module accommodates continuation of power and data distribution services below worksurfaces (specify Below Worksurface Power Trough and power components separately). The 6" d worksurface module with access door provides access to Below Worksurface Power Trough. Backrests are permanently secured to the bench and cannot be reconfigured on site. Tables not included.

• **Only compatible with back-to-back 30" d worksurfaces (62.5" total depth) supported by Bridges rectangular legs.** Not compatible with round legs, 24" d worksurfaces; not compatible with single line table assemblies 24" and 30" d. The kit cannot be used at the end of a table run, nor can it be used as a standalone, freestanding configuration. It must always be supported by back-to-back table assemblies on either side.

- Anodized Aluminum Leg - Add \$54 list upcharge
- High pressure laminate - Add \$195 list upcharge

Required Specifications

Fabric
Laminate finish (enclosure)
Edge finish (enclosure)
Metal finish (legs)

Optional Specifications

Anodized Aluminum Leg
HP laminate (enclosure)

SEATING PARTITIONS

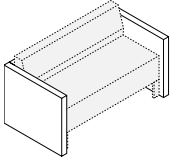

Seat Partitions

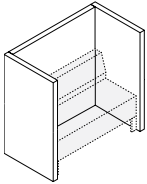

Seat Privacy Partitions

MODEL#	DIMENSIONS	FREIGHT CLASS	WT/LBS.	CUBIC FT.	LIST PRICE
--------	------------	---------------	---------	-----------	------------

D x W x H

BRTPP2448L1	28.7 x 53 x 25	300	41	22.01	\$1433
BRTPP2424L1	28.7 x 29 x 25	250	32	12.04	\$1072

Fully upholstered 2.5" thick, 3-part, low level partition kit wraps around 24" or 48" bridges seat. The seat front is recessed by 2.5". The kit is secured to seats on-site (brackets connecting seat legs to the inner side of the partition are included). Upholstered kits consist of 2" hollow core boards, 1/4" foam, fabric, levelers and connecting hardware. Note: Seats and backrests are not included.

BRTPP2448L2	28.7 x 53 x 50	400	41	44.01	\$2077
BRTPP2424L2	28.7 x 29 x 50	300	32	24.08	\$1623

Fully upholstered 2.5" thick, 3-part, two tier partition kit wraps around 24" or 48" bridges seat. The 50"h assembly provides seated visual privacy. 2.5" thick upholstered partitions improve acoustic privacy for focused time away from the team or for a quiet phone call. Recessed seat extends the partition at the front by 2.5" for enhanced sense of privacy. The kit is secured to seats on-site (brackets connecting seat legs to the inner side of the partition are included). Upholstered kits consist of 2" hollow core boards, 1/4" foam, fabric, levelers and connecting hardware. Note: Seats and backrests are not included.

Required Specifications

Fabric

COLLABORATIVE SEATING

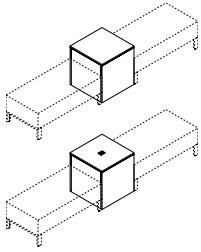
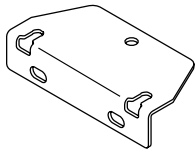
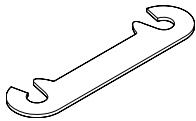
**Square Table Block*****Square Table Block Ganging Bracket Kit****Ganging Bracket Kit**

MODEL#	DIMENSIONS D x W x H	FREIGHT CLASS	WT./LBS.	CUBIC FT.	LIST PRICE	HP ADD
BRTS2424B	24 x 24 x 25	250	32	12.04	\$455	\$65
BRTS2424BP	24 x 24 x 25	125	59.30	8.33	\$909	\$65

Freestanding 24" square table block serves as a visual anchor whenever a bridges seat needs to turn a corner or split into 2, 3 or 4 directions. BRTS2424BP can be positioned directly over a floor monument, which will supply power to the top-mounted power module. This option includes 24"x 24" block chassis and flush-mounted Duo power module (two outlets and two 2.1 amp USB ports, white face plate, outlets and bezel, 72" long three prong black cord). The square table block can function as a self-supporting, freestanding unit or it can be secured permanently to adjacent bridges seats with optional interconnecting brackets listed below. 2 Square Table Ganging Bracket Kits included.

BRTSTBG	2.4 x 5 x 1.1	70	.05	.01	\$33	n/a
---------	---------------	----	-----	-----	-------------	-----

Two square table block ganging brackets connect seat legs permanently to the side of the 24" square table block on site. The kit employs machine screws connecting legs to seats, and ships with wood screws which provide permanent connection to the square table block. Includes 2 brackets and screws. Black powdercoat finish.

BRTSTSB	1.3 x 6 x .1	70	.03	.01	\$14	n/a
---------	--------------	----	-----	-----	-------------	-----

Two ganging brackets connect seat temporarily to adjacent in-line seat or 24" d bridges storage. Black powdercoat finish.

Required Specifications

Top finish*
Edge finish*
Chassis/Accent finish*

Optional Specifications

HP laminate* (top only)

COLLABORATIVE SEATING

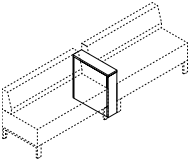

In-line 6" Block

BRTS2406B

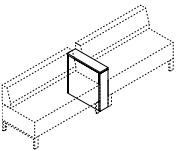

Inline table - no power module or swivel arm

MODEL#	DIMENSIONS D x W x H	FREIGHT CLASS	WT/LBS.	CUBIC FT.	LIST PRICE	HP ADD
BRTS2406B	24 x 6 x 25	92.5	21	2.08	\$390	\$33
BRTS2406BP	24 x 6 x 25	92.5	23.30	2.08	\$844	\$33
BRTS2406B2P	24 x 6 x 25	92.5	24.30	2.08	\$1298	\$33
BRTS2406BT	24 x 6 x 25	85	25.60	2.08	\$747	\$33
BRTS2406BPT	24 x 6 x 25	92.5	24.30	2.08	\$1201	\$33

Multifunctional in-line 6" table block divides seating areas, serves as a utility surface, can support tablet arms, lamps, and double as a power delivery center. It is permanently secured between two bridges seats and cannot be placed at the end of a run. Two Square Table Block Ganging Brackets (BRTSTBG) connect seat legs permanently to the side of the in-line table block on site. The included kit employs machine screws connecting legs to seats and ships with wood screws, which provide permanent connection to the in-line 6" block. Black powdercoat finish. The chassis is available without power module, with one power module or with two vertically embedded power modules. Vertical panel flush-mounted Duo module provides two outlets and two 2.1 amp USB ports; 72" cord exits through the bottom and plugs into a floor monument under seats, white face plate and bezel. 2 Square Table Ganging Bracket Kits included.

- BRTS2406BT and BRTS2406BPT include 9.5" x 14.5" swivel tablet. If top is specified in high pressure laminate, tablet will also be manufactured in high pressure laminate.

BRTS2406BP

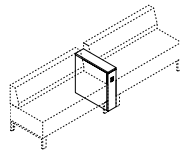

Inline table w/front power module

BRTS2406B2P

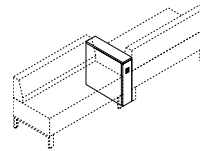

Inline table w/front and rear power module

BRTS2406BT

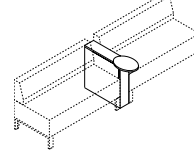

Inline table w/swivel tablet arm

BRTS2406BPT

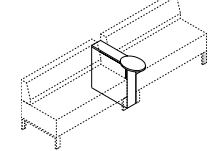

Inline table w/front power module and swivel tablet arm

Required Specifications

Top finish
Edge finish
Chassis/Accent finish

Optional Specifications

HP laminate (top only)

FREEFIT BENCHING



FreeFit offers a universal freestanding design with finish options on bases and surfaces that allow you to easily integrate with existing Global workstation configurations, becoming a part of your workspace. Support individual control and personalization without impeding collaboration. Integrate height adjustability along a bench where you need it, while maintaining a unified aesthetic.

Fabric, laminate, dry erase, magnetic dry erase and glass dividers offer a range of privacy options in open plan applications.

With two concealed motors on each base, FreeFit adjusts at 1.5" per second while emitting just 58db. A "whisper quiet" option emits just 38db – about as quiet as a library. Select from two table ranges: standard range accommodates most users, while extended range meets BIFMA ergonomics guidelines accommodating an extensive array of user needs.



Features and Benefits

- Tops are 1" thick thermally fused laminate or 1 1/16" high pressure laminate
- Tops are constructed of 45 lb. density particle board
- Worksurfaces, electrical troughs and accessories are sold separate from the base.
- Single sided or back-to-back workstations
- Dividers support individual privacy at different work heights.
- Standard up/down handset. Optional digital readout handset.



Access door with optional device holder, USB, power and cable tray



Flip cable tray



Table-to-table connector includes housing to housing harness

GENERAL INFORMATION

- FreeFit Height Adjustable Benching allows for easy movement from sitting to standing and back throughout the day in open office settings.
- Support individual control and personalization without impeding collaboration. Integrate height adjustability along a bench where you need it, while maintaining a unified aesthetic.
- All single sided and back-to-back worksurfaces are sold as a kit. Each kit contains the worksurface, under surface wire management, cable chain, and power distribution harness. Duplexes, table-to-table connectors, and infeed sold separately.
- Global laminate products are in compliance with stringent emission guidelines set out by the Greenguard Environmental Institute under the standards for low emitting products and materials. www.greenguard.org.
- **Level 3 Certified.**

CONSTRUCTION

- 1" thick tops constructed of 45 lb. density particle board with high performance thermally fused laminate.
- All worksurfaces feature Global's preferred matching edge.
- Products specified with the high pressure laminate option are 1-1/16" thick and finished on the underside of the surface with a kraft paper backing.
- Worksurface sizes are "nominal". Main worksurface sizes are 1" less in depth and 2" less in width.
- Steel constructed leg tubing, feet and cross bar.
- Table frame designed with 3.15" x 2.35" rectangular outer leg with the larger tube attached to the foot.
- Back-to-back benching kits feature a pad foot with 1/2" adjustable glides
- Foot on single sided benching is 3.55"W x 1"H (with glides fully recessed).

BASE

- Worksurfaces and troughs are sold separate from the base.
- Powder coat finishes for bases is standard in Designer White (**DWT**), Black (**BLK**) or Tungsten (**TUN**).
- Standard Range Tables have 2-stages and feature an adjustment range of 27.5" – 45.5" (18" travel).
- Extended Range Tables have 3-stages and feature an adjustment range of 22.6" – 48.8" (26.2" travel).
- Lifts 265 pounds.
- Operates at 1.5" per second.
- Shadow power draw is 0.45 watts.
- Maximum power draw is 1.3 amps.
- Open base design has no lower crossbars.
- Table frames include expandable width upper cross bars.
- All products meet or exceed ANSI-BIFMA X5.5-2008 and 7.1 VOC., UL 962 and CSA-C22.2 No. 6809, CAN/CGSB-44.228-2008.
- All Extended Range tables meet the BIFMA G1-2013 Ergonomic Guideline for "recommended input adjustment range."
- All bases feature a dual actuator system with a motor driving each leg.
- Motors daisy-chain and connect directly to one another, without the need for a control box.

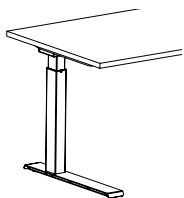

Standard range (2 stage)

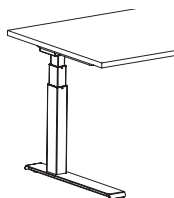

Extended range (3-stage)

HANDSET

- Standard up/down handset (**SH**) (no digital readout). Black only.
- A digital handset with five programmable settings is optional, specify Digital Readout Handset (**DH**). Black only. Add **\$182** for FFHABSKS and FFHABSKE. Add **\$364** for FFHABDKS and FFHABDKE.
 - Digital Readout Handset (**DH**) is recommended when items above or below worksurface might impede full movement of the table. **DH** includes settings to program Upper and Lower Limits, Collision Detection, Sit Position and Stand Position.

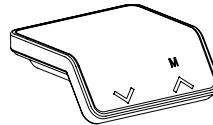

Standard handset (**SH**)

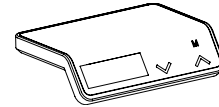

Digital readout handset (**DH**)

FOOT TYPE

- FreeFit back-to-back height adjustable benching features a pad foot with 1/2" adjustable glides.
- Single sided benching includes T-Foot bases only. No substitutes.
 - T-Foot configuration has the column centered on the foot.

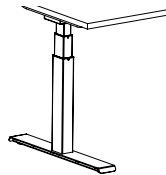

T-foot configuration (**T**)

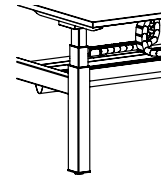

Pad foot for benching

NOISE REDUCTION

- Industry leading operating sound level of 55dB is standard (**SI**).
- Optional whisper quiet sound insulation reduces operating sound level to 38dB. Specify Whisper Quiet Insulation (**QI**). Add **\$84** for FFHABSKS and FFHABSKE. Add **\$167** for FFHABDKS and FFHABDKE.

GROMMET WITH ACCESS DOOR OPTIONS FOR FREEFIT BENCHING

- FreeFit Height Adjustable Benching Surface & Trough Kits with access door grommets offer a range of options for desktop power
- Specify Worksurface & Trough Kits with Access Door Grommets (FFHABDKGxxxx or FFHABSKGxxxx) and it will include the standard access door grommet option (GDL/GDR), with the ability to upgrade to the options outlined below.
 - When specified, device holder is only available in white plastic.
 - When specified, CSA certified power bar includes (3) outlets and (2) charging USB ports (2.1 amp).
 - Choose from locations left or right of center

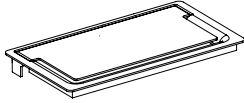

Standard Access Door (GL/GR)

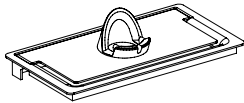

Access Door with Device Holder (GDL/GDR). Add \$13

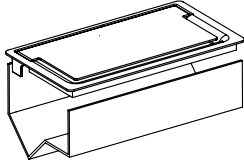

Access Door with Cable Tray (CTL/CTR). Add \$79

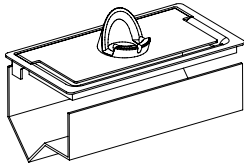

Access Door with Cable Tray & Device Holder (CTDHL/CTDHR). Add \$90

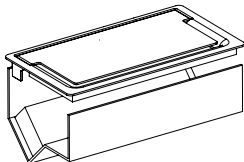

Access Door with Cable Tray & Power Bar (CTPDL/CTPDR). Add \$312

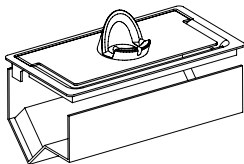

Access Door with Cable Tray, Power Bar & Device Holder (TPDHL/TPDHR). Add \$321

GROMMET LOCATIONS

Back to Back and Single Table Kit Tops

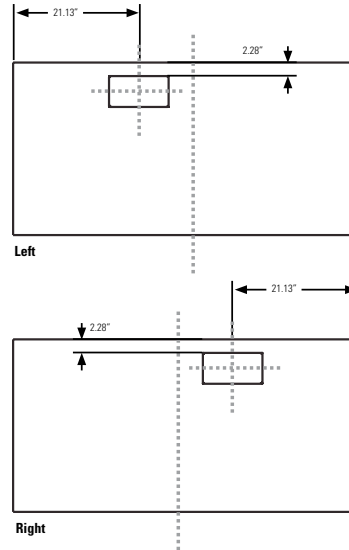

Options for Back-to-Back Height Adjustable Tables

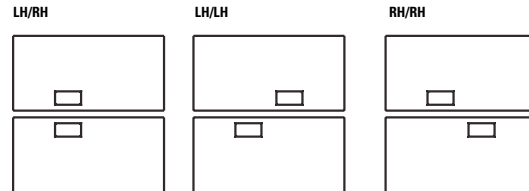

FINISHES

Laminate Top Finishes:

ACJ	Absolute Acajou
ASN	Asian Night
AWC	Avant Cherry
AWH	Avant Honey
BLK	Black - Coordinates with BLK Metal Frame Finish
BRC	Brushed Cobalt - Coordinates with TUN Metal Frame Finish
CMB	Clear Maple
CGY	Custom Grey - Coordinates with SIL Metal Frame Finish
DES	Dark Espresso
DWT	Designer White - Coordinates with DWT Metal Frame Finish
HGT	Hayden Grey
QTM	Quartered Mahogany
SOG	Storm Grey - Coordinates with CHR Metal Frame Finish
STG	String - Coordinates with NEV Metal Frame Finish
TFW	Tiger Fruitwood
TWL	Tiger Walnut
WHE	Walnut Heights
WHC	White Chocolate
WCR	Winter Cherry
WGY	Willow Grey

Base Finishes

BLK	Black
DWT	Designer White
TUN	Tungsten

F FREEFIT BENCHING - NOTES

ELECTRICAL

4-2-2 Wiring Schematic

8-Wire Shared Neutral

"2 + 2" - 2 Utility Circuits, 2 Dedicated

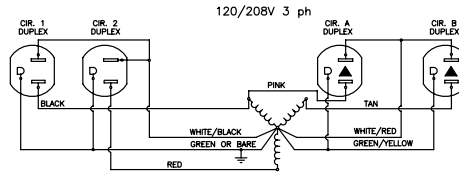
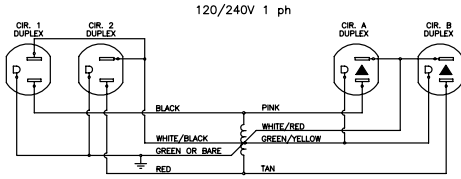

8 Wires

4 Lines (12 ga.)
2 Neutrals (10 ga.)
2 Grounds (12 ga.)

4 Circuits

2 Utility circuits
2 Dedicated Circuits

Receptacles

Duplex - Up to 12 duplex receptacles per circuit
(Up to 48 per infeed)

Specifications

System rated for connection to a grounded 120/240 V single phase, 20A, 60Hz or 120/208 V, 3 phase, 20A, 60Hz branch circuit for U.S. and 15A if product is marked with a C-UL Mark. Outlets rated 15A max.

BACK-TO-BACK SURFACE & TROUGH KITS

MODEL# DIMENSIONS FREIGHT CLASS WT/LBS. CUBIC FT. LIST PRICE HP ADD

D x W x H

24"D Surface & Trough Kits - Standard w/Grommet*:

FFHABDKG4848	23 x 46 x 1	85	62	4.48	\$2426	\$1213
FFHABDKG4854	23 x 52 x 1	85	70	4.72	\$2584	\$1292
FFHABDKG4860	23 x 58 x 1	70	80	4.96	\$2760	\$1380
FFHABDKG4866	23 x 64 x 1	70	86	5.20	\$2829	\$1415
FFHABDKG4872	23 x 70 x 1	70	94	5.44	\$2885	\$1443

24"D Surface & Trough Kits - No Grommet Option:

FFHABDKN4848	23 x 46 x 1	85	62	4.48	\$2301	\$182
FFHABDKN4854	23 x 52 x 1	85	70	4.72	\$2459	\$206
FFHABDKN4860	23 x 58 x 1	70	80	4.96	\$2635	\$230
FFHABDKN4866	23 x 64 x 1	70	86	5.20	\$2704	\$234
FFHABDKN4872	23 x 70 x 1	70	94	5.44	\$2843	\$249

30"D Surface & Trough Kits - Standard w/Grommet*:

FFHABDKG6048	29 x 46 x 1	70	78	4.96	\$2519	\$1260
FFHABDKG6054	29 x 52 x 1	70	88	5.27	\$2639	\$1320
FFHABDKG6060	29 x 58 x 1	70	98	5.57	\$2792	\$1396
FFHABDKG6066	29 x 64 x 1	70	108	5.86	\$2852	\$1426
FFHABDKG6072	29 x 70 x 1	70	118	6.17	\$2931	\$1466

30"D Surface & Trough Kits - No Grommet Option:

FFHABDKN6048	29 x 46 x 1	70	78	4.96	\$2399	\$201
FFHABDKN6054	29 x 52 x 1	70	88	5.27	\$2519	\$201
FFHABDKN6060	29 x 58 x 1	70	98	5.57	\$2667	\$234
FFHABDKN6066	29 x 64 x 1	70	108	5.86	\$2727	\$254
FFHABDKN6072	29 x 70 x 1	70	118	6.17	\$2806	\$258

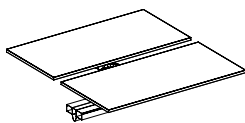
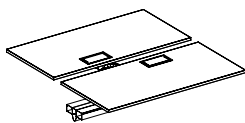
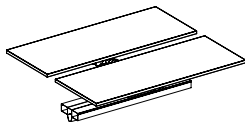
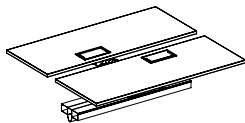

**Back-to-Back Surface & Trough Kits
(Bases sold separate)**

Back-to-Back Surface & Trough kits contain all items needed for a standard back-to-back workstation when combined with the back-to-back height adjustable base (sold separately). Kits include two surfaces, two under surface wire managers, two cable chains and one back-to-back power trough with distribution housing included. Kits can be specified with or without grommet options. Specify duplexes separately.

- For models with grommet options, power bars and accessory holders can be incorporated at an upcharge. Please reference the notes section of this price list (see page 367).

Required specifications

Top finish
Trough finish

Optional specifications

HP laminate
Grommet option

Accessories

Keyboard tray
Power block

F FREEFIT BENCHING

BACK-TO-BACK HAT BASES

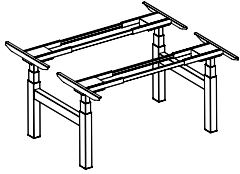
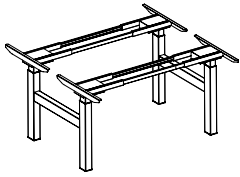

(Surfaces & Troughs sold separate)

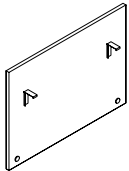

Back-to-Back End Gable*

MODEL#	DIMENSIONS	FREIGHT CLASS	WT/LBS.	CUBIC FT.	LIST PRICE	HP ADD
--------	------------	---------------	---------	-----------	------------	--------

D x W x H

Standard Range Back-to-Back Base:

FFHABDKS	10 x -- x 26.8	65	158	6.17	\$3839	n/a
----------	----------------	----	-----	------	---------------	-----

Extended Range Back-to-Back Base:

FFHABDKE	10 x -- x 26.8	65	158	6.17	\$4126	n/a
----------	----------------	----	-----	------	---------------	-----

Back-to-back height adjustable bases includes four height adjustable columns with pad feet, two sets of cross rails for surface support and two short beams to attach the columns back-to-back. Combine with back-to-back surface & trough kits (sold separately) to create a complete workstation. Lifts 265 lbs. Each motor is mounted within the top of the column and will connect directly into one another without the need for a control box.

- **Recommended torque range for installing all fasteners is 3-5 foot pounds and should not be exceeded. In addition, no impact drivers or high-torque equipment are to be used for any fasteners included in the table assembly kits, as this creates a high risk for damage that is not covered under warranty. The use of hand tools is highly recommended.**

BWAEG18H	30.65 x .75 x 18	60	10	.24	\$372
BWAEG22H	30.65 x .75 x 22	60	13	.30	\$404

Optional back-to-back FreeFit Benching end gable is intended to be installed at the end of a FreeFit back-to-back table run. Made of our 3/4" thermally fused laminate, it reduces the number of visible elements below the worksurface. Two heights are available. Specify BWAEG18H for extended range bases and BWAEG22H for standard range bases.

Required specifications

Base finish
Table width
Laminate finish*

Optional specifications

Digital handset
Insulation type

SINGLE-SIDED SURFACE & TROUGH KITS

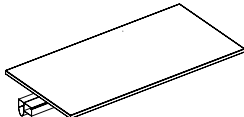
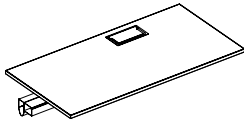
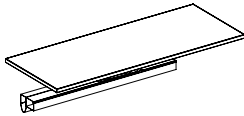
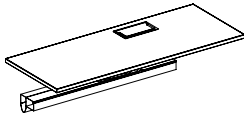

**Single-Sided Surface & Trough Kits
(Bases sold separate)**

MODEL# DIMENSIONS FREIGHT CLASS WT/LBS. CUBIC FT. LIST PRICE HP ADD

D x W x H

24" D Surface & Trough Kits - Standard w/Grommet*:

FFHABSKG2448	23 x 46 x 1	100	31	3.16	\$1536	\$140
FFHABSKG2454	23 x 52 x 1	92.5	35	3.40	\$1646	\$101
FFHABSKG2460	23 x 58 x 1	92.5	39	3.64	\$1761	\$120
FFHABSKG2466	23 x 64 x 1	92.5	43	3.88	\$1817	\$120
FFHABSKG2472	23 x 70 x 1	92.5	47	4.12	\$1880	\$178

24" D Surface & Trough Kits - No Grommet Option:

FFHABSKN2448	23 x 46 x 1	100	31	3.16	\$1474	\$134
FFHABSKN2454	23 x 52 x 1	92.5	35	3.40	\$1585	\$101
FFHABSKN2460	23 x 58 x 1	92.5	39	3.64	\$1699	\$120
FFHABSKN2466	23 x 64 x 1	92.5	43	3.88	\$1756	\$120
FFHABSKN2472	23 x 70 x 1	92.5	47	4.12	\$1817	\$173

30" D Surface & Trough Kits - Standard w/Grommet*:

FFHABSKG3048	29 x 46 x 1	92.5	39	3.64	\$1585	\$106
FFHABSKG3054	29 x 52 x 1	92.5	44	3.94	\$1674	\$106
FFHABSKG3060	29 x 58 x 1	92.5	49	4.24	\$1779	\$120
FFHABSKG3066	29 x 64 x 1	92.5	54	4.54	\$1832	\$173
FFHABSKG3072	29 x 70 x 1	85	59	4.85	\$1932	\$106

30" D Surface & Trough Kits - No Grommet Option:

FFHABSKN3048	29 x 46 x 1	92.5	39	3.64	\$1522	\$101
FFHABSKN3054	29 x 52 x 1	92.5	39	3.64	\$1612	\$101
FFHABSKN3060	29 x 58 x 1	92.5	49	4.24	\$1718	\$120
FFHABSKN3066	29 x 64 x 1	92.5	54	4.54	\$1765	\$178
FFHABSKN3072	29 x 70 x 1	85	59	4.85	\$1866	\$111

Single-sided Surface & Trough kits contain all items needed for a standard single-sided workstation when combined with the single-sided height adjustable base (sold separately). Kits include one surface, one under surface wire manager, one cable chain and one single sided power trough with distribution housing included. Kits can be specified with or without grommet options. Specify duplexes separately.

- For models with grommet options, power bars and accessory holders can be incorporated at an upcharge. Please reference the notes section of this price list (see page 367).

Required specifications

Top finish
Trough finish

Optional specifications

HP laminate
Grommet option*

Accessories

Keyboard tray
Power block*

F FREEFIT BENCHING

SINGLE-SIDED HAT BASES

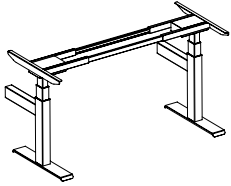
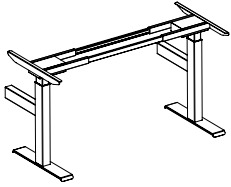

(Surfaces & Troughs sold separate)*

MODEL#	DIMENSIONS	FREIGHT CLASS	WT/LBS.	CUBIC FT.	LIST PRICE	HP ADD
--------	------------	---------------	---------	-----------	------------	--------

D x W x H

Standard Range Single-Sided Base:

FFHABSXS	10 x -- x 26.8	70	78	4.85	\$2028	n/a
----------	----------------	----	----	------	--------	-----

Extended Range Single-Sided Base:

FFHABSKE	10 x -- x 26.8	70	78	4.85	\$2161	n/a
----------	----------------	----	----	------	--------	-----

Single sided height adjustable bases includes two height adjustable columns with "T" feet, one set of cross rails for surface support and two short beams to attach the columns to a trough kit. Combine with single surfaces & trough kits (sold separately) to create a complete workstation. Lifts 265 lbs. Each motor is mounted within the top of the column and will connect directly into one another without the need for a control box.

- **Recommended torque range for installing all fasteners is 3-5 foot pounds and should not be exceeded. In addition, no impact drivers or high-torque equipment are to be used for any fasteners included in the table assembly kits, as this creates a high risk for damage that is not covered under warranty. The use of hand tools is highly recommended.**

ELECTRICAL COMPONENTS

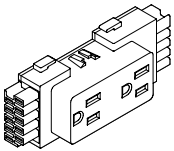

Duplex Receptacles

MODEL#	DIMENSIONS	FREIGHT CLASS	WT/LBS.	CUBIC FT.	LIST PRICE
--------	------------	---------------	---------	-----------	------------

BRTE8D1	1.25 x 4.63 x 2	70	.10	.01	\$29
BRTE8D2	1.25 x 4.63 x 2	70	.10	.01	\$29
BRTE8DA	1.25 x 4.63 x 2	70	.10	.01	\$29
BRTE8DB	1.25 x 4.63 x 2	70	.10	.01	\$29
BRTE8DXW1	1.25 x 4.63 x 2	70	.10	.01	\$42
BRTE8DXW2	1.25 x 4.63 x 2	70	.10	.01	\$42
BRTE8DXWA	1.25 x 4.63 x 2	70	.10	.01	\$42
BRTE8DXWB	1.25 x 4.63 x 2	70	.10	.01	\$42

Snaps into Power Distribution Housing. Up to 13 duplex receptacles per circuit XW identifies white color plastic, all others standard in black.

- BRTE8D1 / BRTE8DXW1 - Circuit #1 (utility circuit)
- BRTE8D2 / BRTE8DXW2 - Circuit #2 (utility circuit)
- BRTE8DA / BRTE8DXWA - Circuit A (dedicated circuit)
- BRTE8DB / BRTE8DXWB - Circuit B (dedicated circuit)

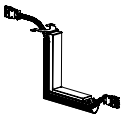

FreeFit to Bridges Connector*

BWABREC	14 x 2.3 x 15	100	2.40	.28	\$264
---------	---------------	-----	------	-----	-------

Connects Freefit back-to-back benching to Bridges 29"H table with below worksurface power trough. Please specify paint finish on bracket. Wire manager is always Charcoal.

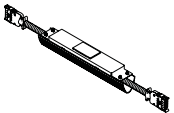

Table to Table Connector*

BWAETTC	2.19 x 14.8 x 3.69	92.5	3.50	.30	\$205
---------	--------------------	------	------	-----	-------

Connects Freefit legs and trough provide to power data/communication pass thru. Connector kit consists of formed steel housing, mounting brackets, housing to housing harness (jumper) and one charcoal grey extruded data/communication cable manager.

Required specifications

Base finish*
Table width*

Optional specifications

Digital handset*
Insulation type*

ELECTRICAL COMPONENTS

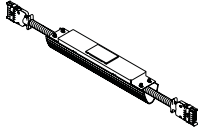

Extended Table to Table Connector*

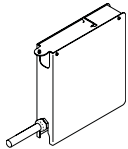

Base Feed*

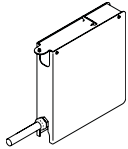

Base Feed* - New York Electrical

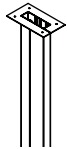

Ceiling Feed Post*

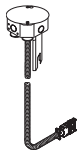

Ceiling Feed Harness

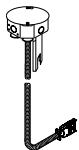

Ceiling Feed

MODEL# DIMENSIONS FREIGHT CLASS WT./LBS. CUBIC FT. LIST PRICE

D x W x H

BWAETTC12	2.3 x 24 x 3.8	60	6	.12	\$274
BWAETTC18	2.3 x 30 x 3.8	60	8	.15	\$292
BWAETTC24	2.3 x 36 x 3.8	60	9	.18	\$311
BWAETTC36	2.3 x 48 x 3.8	60	12	.24	\$343
BWAETTC48	2.3 x 60 x 3.8	60	14	.30	\$394

Connects Freefit legs and trough provide to power data/communication pass thru. Connector kit consists of formed steel housing, mounting brackets, housing to housing harness (jumper) and one charcoal grey extruded data/communication cable manager. Knock out on top cover allows for ceiling post connection. Cover included. Specify paint finish.

- BWAETTC is used between two single sided or back to back stations
- BWAETTC12 is used when a 12" w FreeFit pantry tower separates two stations
- BWAETTC18 is used when a 18" w FreeFit pantry tower separates two stations
- BWAETTC24 is used when a (2) 12" w FreeFit pantry tower separates two stations
- BWAETTC36 is used when a (2) 18" w FreeFit pantry tower separates two stations
- BWAETTC48 is used when storage up to 48" w separates two stations.

BWAEEF	14 x 2.55 x 13.41	92.5	3.50	.30	\$547
--------	-------------------	------	------	-----	--------------

Floor feed housing for FreeFit benching applications only. Includes liquitite whip , 72" L. Must be hard wired to the building power supply by a licensed electrician.

BWAEEF-NYC	14 x 2.55 x 13.41	92.5	3.50	.30	\$547
------------	-------------------	------	------	-----	--------------

Floor feed housing for FreeFit benching applications only. Includes liquitite whip , 72" L. Must be hard wired to the building power supply by a licensed electrician.

BWAECF	2.5 x 4.74 x 99.32	92.5	3.50	.30	\$315
--------	--------------------	------	------	-----	--------------

Ceiling pole brings ceiling feed conduit and data cables from the ceiling down to Power troughs height. Accommodates 10' ceiling heights. A two part construction allows power/data conduit lay-in. Includes mounting hardware and ceiling bezel. Ceiling feed harness sold separately.

BWAEECFH120	6 x 6 x 120	250	5	2	\$389
BWAEECFH144	6 x 6 x 144	250	6	3	\$433

Ceiling feed provides a single power entry from ceiling, through Ceiling pole into Power Trough, into Power Distribution Housing. An 8-wire (4-circuit) metal conduit harness with included metal junction box for hard wiring to the building power supply above ceiling tile. Must be hard wired to the building power supply by a licensed electrician. Ceiling feed post sold separately.

BRTECF120	6 x 6 x 120	250	5	2	\$350
BRTECF144	6 x 6 x 144	250	5	2	\$389

Provides single power entry from ceiling, through ceiling pole into Power Trough, into Power Distribution Module. An 8 wire (4 circuit) metal conduit harness with included metal junction box for hard wiring to the building power supply above ceiling tile. Must be hard wired to the building power supply by a licensed electrician. Ceiling Pole not included.

Required specifications

Metal finish*

F FREEFIT BENCHING

SINGLE TABLE; 21" H DIVIDERS

D x W x H

- FreeFit table mounted dividers for single table or single table row; recessed 6.5" at both ends (for example - 72" (70" actual) FreeFit table mounted divider measures 57").
- The center of all dividers is always mounted 2.25" from worksurface's rear edge. Please note the gap between the divider and the worksurface therefore varies, depending on the divider thickness (1.25" framed dividers. 0.75" frameless LP and 0.25" frameless glass).
- 48" (33" actual) - 66" (51" actual) dividers have 2 mounting brackets.
- 72" (57" actual) dividers have 3 mounting brackets.

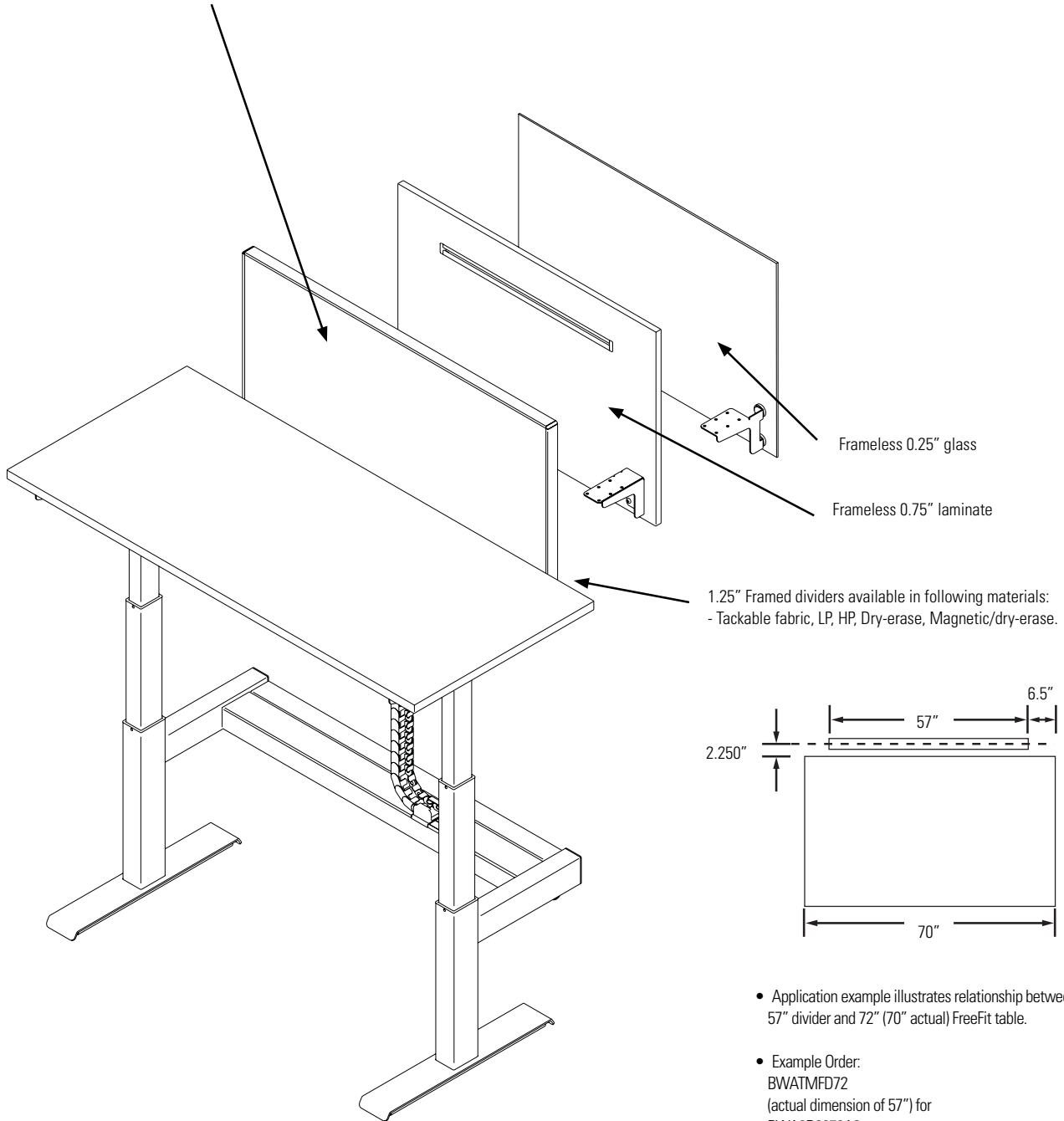

- Application example illustrates relationship between 57" divider and 72" (70" actual) FreeFit table.
- Example Order:
BWATMFD72
(actual dimension of 57") for
BWA2D3072A8
(actual dimension of 70").

BACK-TO-BACK TABLE; 37"H DIVIDERS

D x W x H

FreeFit Back-to-Back stationary dividers; stationary, shared, secured to table structure; recessed 6.5" at both ends (for example - 72" (70" actual) FreeFit table mounted divider measures 57").

The center of all dividers is always mounted 2.25" from worksurface's rear edge. Please note the gap between the divider and the worksurface therefore varies, depending on the divider thickness (1.25" Framed dividers, 0.75" frameless LP and 0.25" frameless glass).

48" (33" actual) divider for 48" (46" actual) table
 54" (39" actual) divider for 54" (52" actual) table
 60" (45" actual) divider for 60" (58" actual) table
 66" (51" actual) divider for 66" (64" actual) table
 72" (57" actual) divider for 72" (70" actual) table

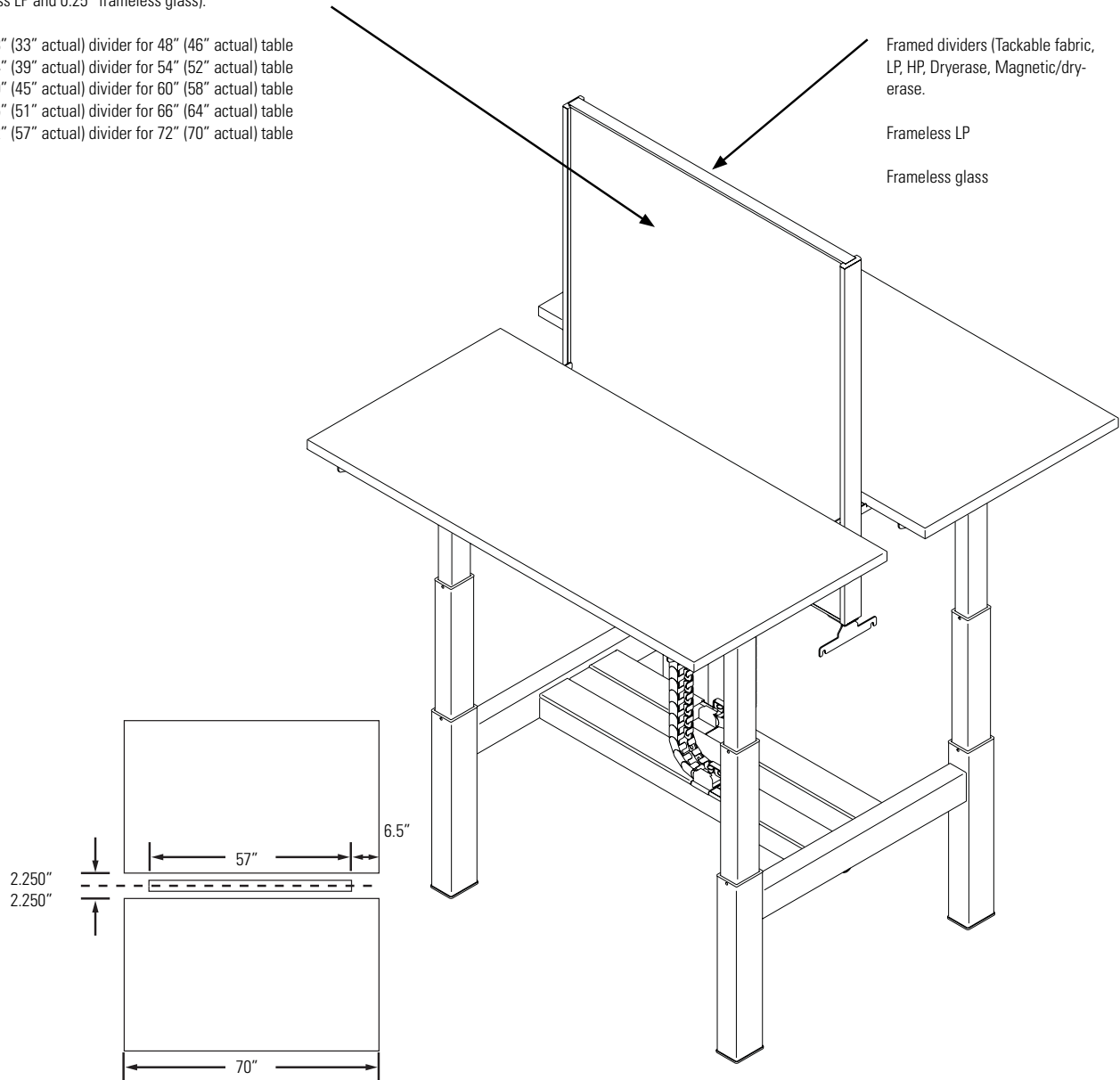

Application example illustrates relationship between 57" shared divider and 72" (70" actual) FreeFit Back-to-Back table.

- Example Order:
 BWASFD72
 (actual dimension of 57") for
 BWA2D6072A8
 (actual dimension of 70").

F FREEFIT BENCHING

FELT DIVIDERS

- 9mm thick panels offered in 9 finishes
- Made from 100% PET (polyester) fiber with a high content (50%) of post-recycled material, free of added chemicals, binders and adhesives
- Lightweight panels are tackable, impact and tear resistant, bacteria resistant, moisture resistant, and installation friendly
- Variation in fiber mix and color are inherent to the character of the product

FELT COLORS

BLK	Black	MTS	Mist
BRI	Brick	PWT	Pewter
DEN	Denim	SHR	Shamrock
GPH	Graphite	WHT	White
HVT	Harvest		

BRACKET FINISH

BLK	Black
DWT	Designer White
TUN	Tungsten

D x W x H

FELT DIVIDERS

MODEL#

DIMENSIONS

FREIGHT CLASS

WT./LBS.

CUBIC FT.

LIST PRICE

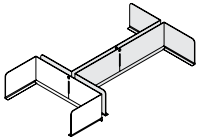
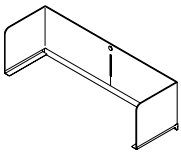

Felt Wrap Around Divider*

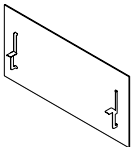

Felt Parallel Divider

BWAFWR2346	18.46 x 46.84 x 18.24	65	26.58	1.07	\$431
BWAFWR2352	18.46 x 52.84 x 18.24	65	28.40	1.21	\$456
BWAFWR2358	18.46 x 58.84 x 18.24	65	30.22	1.34	\$481
BWAFWR2364	18.46 x 64.84 x 18.24	60	32.02	0.74	\$636
BWAFWR2370	18.46 x 70.84 x 18.24	60	33.84	0.81	\$678
BWAFWR2946	24.46 x 46.84 x 18.24	65	30.74	1.07	\$488
BWAFWR2952	24.46 x 52.84 x 18.24	60	32.55	0.60	\$643
BWAFWR2958	24.46 x 58.84 x 18.24	60	34.37	0.67	\$686
BWAFWR2964	24.46 x 64.84 x 18.24	60	36.19	0.74	\$728
BWAFWR2970	24.46 x 70.84 x 18.24	60	38	0.81	\$771

End of Run:

BWAFWR2351	18.46 x 51.34 x 18.24	65	27.94	1.05	\$436
BWAFWR2951	24.46 x 51.34 x 18.24	60	32.09	0.62	\$642
BWAFWR2363	18.46 x 63.34 x 18.24	70	31.57	1.50	\$634
BWAFWR2963	24.46 x 63.34 x 18.24	60	35.73	0.87	\$726

Wraps around Freefit tables to provide privacy. 9mm thick PET felt divider is tackable. Fastens to the underside of the worksurface. Installed divider measures 15.7" from the top of the worksurface. Divider extends 1.5" past the back of the worksurface. Please choose standard base finish for the extrusion and brackets. PET is available in 9 felt colors. Please specify.

- Anodized Aluminum extrusion - Add **\$120** list upcharge

BWAFP2246	6.45 x 33 x 21.5	250	2.62	0.94	\$376
BWAFP2252	6.45 x 39 x 21.5	250	2.85	1.12	\$392
BWAFP2258	6.45 x 45 x 21.5	250	3.08	1.29	\$406
BWAFP2264	6.45 x 51 x 21.5	250	3.31	1.46	\$433
BWAFP2270	6.45 x 57 x 21.5	250	4.22	1.63	\$589

Connects parallel on Freefit tables. 9mm thick PET felt divider is tackable. Fastens to the underside of the worksurface. 1.625" gap between worksurface and divider allows for cable pass-through. Installed divider measures 15.7" from the top of the worksurface and 5.75" below the worksurface. 34" to 58" dividers include 2 brackets. 64" to 70" dividers include 3 brackets. Available in 9 PET felt colors. Please specify.

Required Specifications

Felt color
Bracket finish

Optional Specifications

Anodized extrusion

TABLE MOUNTED DIVIDERS

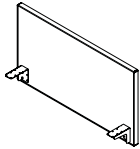

Table Mounted Framed Divider, Fabric*

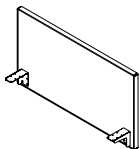

Table Mounted Framed Divider, Laminate**

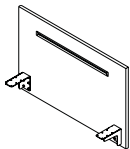

Table Mounted Laminate Divider**

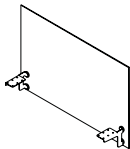

Table Mounted Glass Divider

MODEL#	DIMENSIONS D x W x H	FREIGHT CLASS	WT/LBS.	CUBIC FT.	LIST PRICE
BWATMFD48	1.25 x 33 x 21.5	85	16	1.23	\$316
BWATMFD54	1.25 x 39 x 21.5	85	18	1.46	\$391
BWATMFD60	1.25 x 45 x 21.5	92.5	20	1.68	\$428
BWATMFD66	1.25 x 51 x 21.5	92.5	22	1.90	\$480
BWATMFD72	1.25 x 57 x 21.5	85	26	2.13	\$525

Connects parallel on single and back-to-back tables. Fabric divider is tackable. Fastens to the underside of the worksurface. 1.625" gap between worksurface and divider allows for cable pass-through. Installed divider measures 15.7" from top of worksurface and 5.75" below the worksurface. 48" to 66" dividers include 2 support brackets. 72" divider includes 3 support brackets. Available in the following textiles:

- Global: **Anchorage, Lola, Brinx, Mariposa, Merge, and Accent**
- Momentum: **Meander, Tracery and Universe (extended lead time).**

					LIST PRICE	HP ADD	DE ADD	DM ADD
BWATMLD48	1.25 x 33 x 21.5	85	35	2.46	\$208	\$121	\$275	\$420
BWATMLD54	1.25 x 39 x 21.5	85	39	2.92	\$235	\$156	\$344	\$531
BWATMLD60	1.25 x 45 x 21.5	85	44	3.36	\$278	\$164	\$362	\$565
BWATMLD66	1.25 x 51 x 21.5	85	48	3.80	\$321	\$227	\$757	\$1122
BWATMLD72	1.25 x 57 x 21.5	85	52	4.26	\$349	\$228	\$751	\$1115

Connects parallel on single and back-to-back tables. Divider infill can be specified in low pressure laminate (**LP**), high pressure laminate (**HP**), dry erase whiteboard (**DE**) or dry erase magnetic whiteboard (**DM**) user side only. Fastens to the underside of the worksurface. 1.625" gap between worksurface and divider allows for cable pass-through. Installed divider measures 15.7" from top of worksurface and 5.75" below the worksurface. 48" to 66" dividers include 2 support brackets. 72" divider includes 3 support brackets. When dry erase magnetic whiteboard (**DM**) is specified it is applied user side **ONLY** and dry erase whiteboard (**DE**) is applied on the opposite side.

BWATMLLD48	.75 x 33 x 21.5	125	16	2.46	\$249
BWATMLLD54	.75 x 39 x 21.5	125	19	2.92	\$264
BWATMLLD60	.75 x 45 x 21.5	125	21	3.36	\$279
BWATMLLD66	.75 x 51 x 21.5	125	24	3.80	\$414
BWATMLLD72	.75 x 57 x 21.5	125	27	4.26	\$427

Connects parallel on single and back-to-back tables. Laminate divider with integrated accessory rail, installed on one side only. Integrated anodized aluminum accessory rail, white cut out and rail trims; white power coat brackets. 3/4" LP PVC edged boards. Specify laminate and PVC edge. Fastens to the underside of the worksurface. 1.88" gap between worksurface and divider allows for cable pass-through. Installed divider measures 15.7" from top of worksurface and 5.75" below the worksurface. 48" to 66" dividers include 2 support brackets. 72" divider includes 3 support brackets.

BWATMGD48	.25 x 33 x 21.5	125	16	2.46	\$533
BWATMGD54	.25 x 39 x 21.5	125	19	2.92	\$574
BWATMGD60	.25 x 45 x 21.5	125	22	3.36	\$616
BWATMGD66	.25 x 51 x 21.5	125	24	3.80	\$652
BWATMGD72	.25 x 57 x 21.5	125	28	4.26	\$694

Frameless glass divider connects parallel on single and back-to-back tables. Tempered glass, acid etched on one side (similar to frosted), satin chrome disc fasteners and white powder coated steel support brackets. Fastens to the underside of the worksurface. 2.13" gap between worksurface and divider allows for cable pass-through. Installed divider measures 15.7" from top of worksurface and 4.75" below the worksurface. 48" to 66" dividers include 2 support brackets. 72" divider includes 3 support brackets. 1/2" radius on all four corners.

Required specifications

- Fabric*
- Laminate finish**
- Metal frame finish

F FREEFIT BENCHING

STATIONARY DIVIDERS

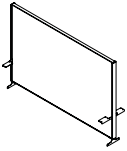

Stationary Framed Divider, Fabric*

MODEL#	DIMENSIONS D x W x H	FREIGHT CLASS	WT./LBS.	CUBIC FT.	LIST PRICE
BWASFD48	1.25 x 33 x 37.2	92.5	25	2.13	\$693
BWASFD54	1.25 x 39 x 37.2	92.5	28	2.52	\$707
BWASFD60	1.25 x 45 x 37.2	92.5	31	2.91	\$730
BWASFD66	1.25 x 51 x 37.2	92.5	34	3.29	\$776
BWASFD72	1.25 x 57 x 37.2	92.5	37	3.68	\$991

Provides a stationary framed divider between back-to-back height adjustable tables. Fabric divider is tackable. Divider is anchored to the base and captured between two aluminum upright tracks. The uprights have sliding brackets that connect the worksurfaces to the divider providing continuous support as it travels up and down. 1.625" gap between worksurface and divider allows for cable pass-through. Installed divider measures 54" from floor. Available in the following textiles:

- Global: **Anchorage, Lola, Brinx, Mariposa, Merge, and Accent**
- Momentum: **Meander, Tracery and Universe (extended lead time).**

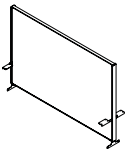

Stationary Framed Divider, Laminate**

					LIST PRICE	HP ADD	DE ADD	DM ADD
BWASLD48	2 x 33 x 37.2	65	58	2.13	\$881	\$314	\$689	\$1806
BWASLD54	2 x 39 x 37.2	65	66	2.52	\$949	\$336	\$725	\$1899
BWASLD60	2 x 45 x 37.2	65	73	2.91	\$965	\$337	\$725	\$1900
BWASLD66	2 x 51 x 37.2	65	81	3.29	\$1038	\$377	\$1584	\$3815
BWASLD72	2 x 57 x 37.2	65	88	3.68	\$1420	\$561	\$1523	\$3872

Provides a stationary framed divider between back-to-back height adjustable tables. Divider infill can be specified in low pressure laminate (**LP**), high pressure laminate (**HP**), dry erase whiteboard (**DE**) or dry erase magnetic whiteboard (**DM**) user side only. Divider is anchored to the base and captured between two aluminum upright tracks. The uprights have sliding brackets that connect the worksurfaces to the divider providing continuous support as it travels up and down. 1.625" gap between worksurface and divider allows for cable pass-through. Installed divider measures 54" from floor.

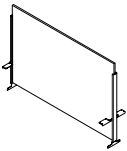

Stationary Laminate Divider**

BWASLLD48	2 x 33 x 37.2	85	28	2.13	\$504
BWASLLD54	2 x 39 x 37.2	85	33	2.52	\$520
BWASLLD60	2 x 45 x 37.2	85	37	2.91	\$534
BWASLLD66	2 x 51 x 37.2	85	41	3.29	\$810
BWASLLD72	2 x 57 x 37.2	85	46	3.68	\$826

Provides a stationary laminate divider between back-to-back height adjustable tables. Divider is anchored to the base and captured between two aluminum upright tracks. The uprights have sliding brackets that connect the worksurfaces to the divider providing continuous support as it travels up and down. 1.88" gap between worksurface and divider allows for cable pass-through. Installed divider measures 54" from floor.

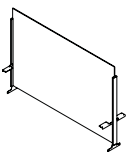

Stationary Glass Divider

BWASGD48	2 x 33 x 37.2	85	30	2.13	\$473
BWASGD54	2 x 39 x 37.2	85	34	2.52	\$538
BWASGD60	2 x 45 x 37.2	85	39	2.91	\$610
BWASGD66	2 x 51 x 37.2	85	43	3.29	\$676
BWASGD72	2 x 57 x 37.2	85	48	3.68	\$742

Provides a stationary glass divider between back-to-back height adjustable tables. Tempered glass, acid etched on one side (similar to frosted), satin chrome disc fasteners and white powder coated steel support brackets. Divider is anchored to the base and captured between two aluminum upright tracks. The uprights have sliding brackets that connect the worksurfaces to the divider providing continuous support as it travels up and down. 2.13" gap between worksurface and divider allows for cable pass-through. 1/2" radius on top two corners.

Required specifications

- Fabric*
- Laminate finish**
- Metal frame finish

ACCESSORIES

MODEL# DIMENSIONS FREIGHT CLASS WT./LBS. CUBIC FT. LIST PRICE

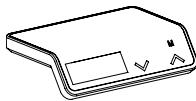

Digital Handset

D x W x H					
FFDH	3 x 3.75 x 1.1	70	.33	.01	\$284

Joggle Wheel Digital Handset with five programmable settings is optional when specifying each table base (Option **DH**), or may be ordered to upgrade handsets already installed. Silver finish only.

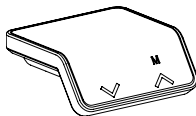

Standard Handset

FFSH	3 x 3.75 x 1.5	70	.33	.01	\$78
------	----------------	----	-----	-----	-------------

Standard Handset with simple up/down buttons is standard on each table or may be ordered as replacements. Black finish only.

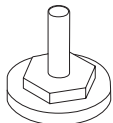

Extended Glide

FFGE	1.5 x 1.5 x 1.45	70	.06	.01	\$20
------	------------------	----	-----	-----	-------------

Extended glides, increase adjustment range to 1.55" to 2" over standard adjustment from the standard 1.15" to 1.55".

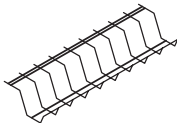

Wire Cable Tray

FFWCT18	2.85 x 18 x 1.5	70	3.50	.22	\$29
---------	-----------------	----	------	-----	-------------

Wire cable tray affixes to the underside of any surface with two screws. Includes all hardware to attach. Black finish only.

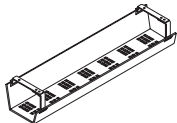

Flip Cable Tray

FFFCT2460	6.25 x 14.75 x 3.9	250	3.50	1.20	\$216
FFFCT3864	6.25 x 26.75 x 3.9	150	6.25	1.20	\$234

Flip cable tray is installed under one crossbeam between the motor on a "C-Foot" base and is attached behind the last cross beam. Easily access cables by flipping the tray down. Includes all hardware to attach. Black finish only.

- FFFCT2460 expands from 14.75" to 26.95".
- FFFCT3864 expands from 26.75" to 50.35".



Cable Channel Leg*

FFCCLE18	1.6 x 2.45 x 17.15	70	.75	.22	\$91
----------	--------------------	----	-----	-----	-------------

Affixes to the lower portion of FreeFit Table legs.

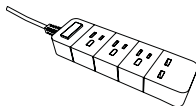

Power Bar with USB

BWAEGC00158GC	1 x 2.3 x 1.3	70	1	.50	\$106
---------------	---------------	----	---	-----	--------------

Power Bar with 3 receptacles + 2 USB and power switch. Standard with 6' cord. Rating 15A, 125V, AC 60Hz, 1875W. USB output 5V, 2.6A (max.) White case, white cord. Available to retrofit CTL/CTR or CTDHL/CTDHR.

Required specifications

Cable channel leg finish*

F FREEFIT BENCHING

ACCESSORIES

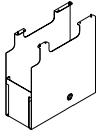

PC Holder

MODEL#	DIMENSIONS D x W x H	FREIGHT CLASS	WT./LBS.	CUBIC FT.	LIST PRICE
BWAPCH	20.5 x 8.21 x 20.32	85	3.50	.30	\$247

Accepts tower CPU's with a width range from 7.6" to 2.25"- and a maximum height of 18". Durable sheet metal construction. Available in standard panel frame painted finishes.

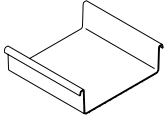

Under Worksurface Wire Manager

BWAWRM	5.55 x 5 x 1.5	70	.01	.01	\$21
--------	----------------	----	-----	-----	-------------

Extruded wire manger snaps on to the underside of any Freefit table to conceal wiring.

- 48" single table require 2 units
- 54" single table require 3 units
- 60" & 66" single table require 4 units
- 72" single table require 5 units
- For Back-to-back tables please double the quantity. NOTE: Already included in back-to-back table kits, additional can be added for single tables.

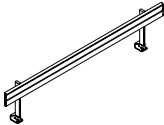

Single Table Accessory Rail

BRLBST36	2.95 x 33 x 16	65	5.90	.26	\$298
BRLBST42	2.95 x 39 x 16	70	6.44	.30	\$313
BRLBST48	2.95 x 45 x 16	70	6.98	.35	\$324
BRLBST54	2.95 x 51 x 16	70	7.52	.39	\$336
BRLBST60	2.95 x 57 x 16	70	8.07	.43	\$344

Table mounted accessory rail. Compatible with standard Bins, Trays and Sorters. Includes end caps and mounting hardware. Please specify paint finish. To ensure proper connection and clearance on tables 46" wide and up, choose accessory rail 13" smaller than the actual table width (70" wide table gets 57" wide rail). Tables 40" wide and smaller use 33" wide accessory rail.

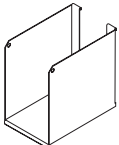

Binder Bin

BABB01	10.25 x 4 x 9	100	2	.21	\$50
--------	---------------	-----	---	-----	-------------

Load bar/accessory rail mounted metal binder bin.

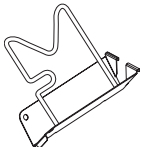

Flip Sorter

BAFS01	9.25 x 2.75 x 9.25	70	.06	.14	\$38
--------	--------------------	----	-----	-----	-------------

Load bar/accessory rail mounted metal flip sorter. Comes with chrome wire.

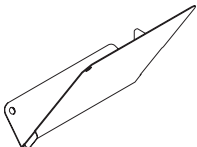

Slant Sorter

BASS01L (Left)	10.25 x 5 x 9.5	70	1	.28	\$31
BASS01R (Right)	10.25 x 5 x 9.5	70	1	.28	\$31

Load bar/accessory rail mounted metal slant sorter.

Required specifications

Metal finish

ACCESSORIES

MODEL# DIMENSIONS FREIGHT CLASS WT/LBS. CUBIC FT. LIST PRICE

D x W x H

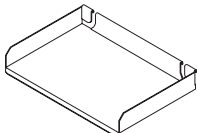

Letter/Legal Tray

BALTO1 (Letter)	9.25 x 13.5 x 2	70	.05	.15	\$41
BALTO1LGL (Legal)	9.25 x 15 x 2	70	.05	.15	\$51

Load bar/accessory rail mounted metal letter or legal tray.

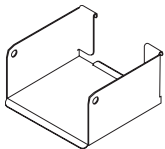

Media Bin

BAMB01	5.25 x 5.75 x 3	70	.08	.05	\$41
--------	-----------------	----	-----	-----	-------------

Load bar/accessory rail mounted metal media bin.

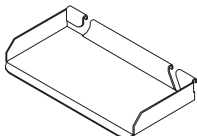

Utility Tray

BAUT01	3.75 x 5.75 x 3	70	.05	.02	\$27
--------	-----------------	----	-----	-----	-------------

Load bar/accessory rail mounted metal utility tray.

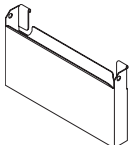

Mail Box

BAPP01	2.75 x 16 x 9	100	2	.25	\$64
--------	---------------	-----	---	-----	-------------

Load bar/accessory rail mounted metal mail box.

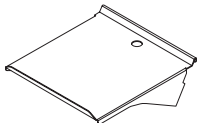

Telephone Holder

BATH01	10 x 9 x 2	125	2	.26	\$61
--------	------------	-----	---	-----	-------------

Load bar/accessory rail mounted metal telephone holder.

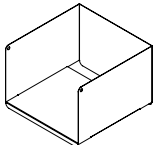

Elevated Shelf Binder Bin

BRTESBBIN	12 x 12 x 8	100	6	.66	\$132
-----------	-------------	-----	---	-----	--------------

Load bar/accessory rail mounted elevated shelf binder bin.

Required specifications

Finish

F FREEFIT BENCHING

PANTRY STORAGE

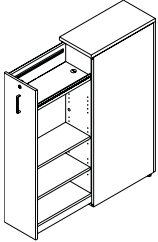

Pantry Storage

MODEL#	DIMENSIONS D x W x H	FREIGHT CLASS	WT/LBS.	CUBIC FT.	LIST PRICE	HP ADD
FFPO1224L	24 x 12 x 49.5	70	133	8	\$1553	\$348
FFPO1230L	30 x 12 x 49.5	85	148	10	\$1653	\$373
FFPO1236L	36 x 12 x 49.5	92.5	162	15	\$1757	\$398
FFPO1224R	24 x 12 x 49.5	70	133	8	\$1553	\$348
FFPO1230R	30 x 12 x 49.5	85	148	10	\$1653	\$373
FFPO1236R	36 x 12 x 49.5	92.5	162	15	\$1757	\$398
FFPO1824L	24 x 18 x 49.5	85	161	12	\$1782	\$403
FFPO1830L	30 x 18 x 49.5	92.5	177	15	\$1892	\$431
FFPO1836L	36 x 18 x 49.5	92.5	192	18	\$2004	\$480
FFPO1824R	24 x 18 x 49.5	85	161	12	\$1782	\$403
FFPO1830R	30 x 18 x 49.5	92.5	177	15	\$1892	\$431
FFPO1836R	36 x 18 x 49.5	92.5	192	18	\$2004	\$480

The pull out cabinet serves as a multifunctional, customizable storage unit that both defines space and enhances privacy in an open plan environment. Internal organization consists of two fixed shelves on the top and bottom. The two middle shelves are adjustable. Two accessory rails (each 18.25" long) are standard and will accept metal accessories (sold separately - see previous page). Interior cabinet shelves and back are standard in Designer White. Cabinet shell, drawer and top can be specified in any standard laminate.

- For Dual USB outlet kit, specify **USB** and **add \$408**. When specified, the top shelf will come with grey felt surface and grommet which allows for cable passage from the USB outlet (located below the top shelf). A 2-prong power cord exits the cabinet through the floor at the back.
- For Dry-erase marker board, specify **DE** and **add \$288**. If specified, the dry-erase marker laminate will be applied to the external surface of the pull-out drawer side wall.

Required specifications

Laminate finish

Optional specifications

HP laminate
Dual USB or Dry-erase board

WELLNESS SCREENS

MODEL# DIMENSIONS FREIGHT CLASS WT/LBS. CUBIC FT. LIST PRICE

D x W x H

FFTDP2436H24	31.75 x 34 x 24.6	125	26.55	3.94	\$831
FFTDP2442H24	31.75 x 40 x 24.6	125	28.10	4.59	\$857
FFTDP2448H24	31.75 x 46 x 24.6	150	29.65	5.25	\$881
FFTDP2454H24	31.75 x 52 x 24.6	150	31.20	5.94	\$907
FFTDP2460H24	31.75 x 58 x 24.6	150	32.75	6.56	\$932
FFTDP2466H24	31.75 x 64 x 24.6	150	34.30	7.22	\$956
FFTDP2472H24	31.75 x 70 x 24.6	150	35.85	7.88	\$982
FFTDP2478H24	31.75 x 76 x 24.6	150	37.40	8.53	\$1007
FFTDP2484H24	31.75 x 82 x 24.6	150	38.95	9.19	\$1033

FFTDP3036H24	37.75 x 34 x 24.6	100	40.50	4.72	\$890
FFTDP3042H24	37.75 x 40 x 24.6	125	42.05	5.51	\$916
FFTDP3048H24	37.75 x 46 x 24.6	125	43.60	6.29	\$941
FFTDP3054H24	37.75 x 52 x 24.6	125	45.15	7.08	\$967
FFTDP3060H24	37.75 x 58 x 24.6	150	46.70	7.85	\$991
FFTDP3066H24	37.75 x 64 x 24.6	150	48.25	8.65	\$1016
FFTDP3072H24	37.75 x 70 x 24.6	150	49.80	9.44	\$1042
FFTDP3078H24	37.75 x 76 x 24.6	150	51.35	10.22	\$1067
FFTDP3084H24	37.75 x 82 x 24.6	150	52.90	11.01	\$1092

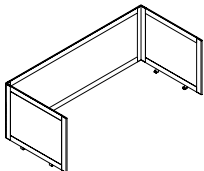

24" H Divider Screen

Powder coated aluminum frame, translucent ribbed polycarbonate. Includes all hardware to connect. Brackets are painted steel. Side dividers extend 7.25" from the front edge of each surface. Back divider extends over the back edge of the worksurface by 1.5", allowing for cable pass-through to trough. Width and depth are nominal sizes representing the sizes of the FreeFit table. Allow for .25" overhang at the sides, 1.5" at the back, and 7.25" at the front. Frame available in Black (BLK), Designer White (DWT) and Tungsten (TUN).

- FFTDP24xxH24 are for configurations with 23" deep surfaces.
- FFTDP30xxH24 are for configurations with 29" deep surfaces.

FFTDP2436H30	31.75 x 34 x 30.6	125	26.55	3.94	\$932
FFTDP2442H30	31.75 x 40 x 30.6	125	28.10	4.59	\$962
FFTDP2448H30	31.75 x 46 x 30.6	150	29.65	5.25	\$991
FFTDP2454H30	31.75 x 52 x 30.6	150	31.20	5.91	\$1019
FFTDP2460H30	31.75 x 58 x 30.6	150	32.75	6.56	\$1049
FFTDP2466H30	31.75 x 64 x 30.6	150	34.30	7.22	\$1077
FFTDP2472H30	31.75 x 70 x 30.6	150	35.85	7.88	\$1107
FFTDP2478H30	31.75 x 76 x 30.6	150	37.40	8.53	\$1135
FFTDP2484H30	31.75 x 82 x 30.6	150	38.95	9.19	\$1164

FFTDP3036H30	37.75 x 34 x 30.6	100	40.50	4.72	\$989
FFTDP3042H30	37.75 x 40 x 30.6	125	42.05	5.51	\$1019
FFTDP3048H30	37.75 x 46 x 30.6	125	43.60	6.29	\$1048
FFTDP3054H30	37.75 x 52 x 30.6	125	45.15	7.08	\$1075
FFTDP3060H30	37.75 x 58 x 30.6	150	46.70	7.87	\$1105
FFTDP3066H30	37.75 x 64 x 30.6	150	48.25	8.65	\$1134
FFTDP3072H30	37.75 x 70 x 30.6	150	49.80	9.44	\$1162
FFTDP3078H30	37.75 x 76 x 30.6	150	51.35	10.22	\$1192
FFTDP3084H30	37.75 x 82 x 30.6	150	52.90	11.01	\$1221

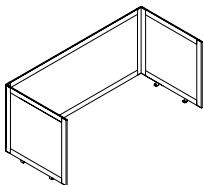

30" H Divider Screen

Powder coated aluminum frame, translucent ribbed polycarbonate. Includes all hardware to connect. Brackets are painted steel. Side dividers extend 7.25" from the front edge of each surface. Back divider extends over the back edge of the worksurface by 1.5", allowing for cable pass-through to trough. Width and depth are nominal sizes representing the sizes of the FreeFit table. Allow for .25" overhang at the sides, 1.5" at the back, and 7.25" at the front.

- FFTDP24xxH30 are for configurations with 23" deep surfaces.
- FFTDP30xxH30 are for configurations with 29" deep surfaces.

Required specifications

Frame finish



Sidebar is well suited to the modern workplace. The wide range of options within the series allow for the product to be specified as a collaborative work environment in an open floor plan, or in private and semi-private settings all while keeping a similar, leg based aesthetic. Fun, unique and functional storage items provide personal touches to the workspace all while maintaining a practical appeal.

Varying levels of benching, dividers and storage heights create unique visual planes within the workspace, providing a break from the monotonous “cube farms” of the past. Multiple leg and foot styles are available and convey transitional or contemporary overtones, allowing the product to fit well within a variety of environments.

Features and Benefits

- All worksurfaces are 1” thick, constructed of 45 lb. density particle board covered on both sides with high performance thermally fused laminate.
- Worksurfaces available in four detail options.
- Tapered legs feature adjustable glides and can be painted in Black (BK) or Silver (SI).
- Tiered storage enhances the visuals of any office setting

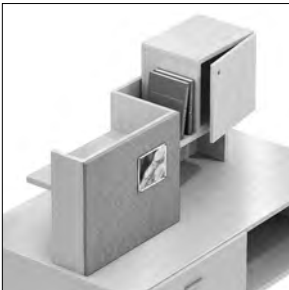

Shared storage



Wire pass-through



Low credenza storage with cushion

GENERAL INFORMATION

- SideBar features benching and desking components for use in open office, semi-private and private office settings.
- Melding the popular aesthetic of multiple series into a new series, SideBar is a great complement to Bungee & Bungee SL training tables as well as Zira Desking.
- Starter and add-on benching components are easy to specify and allow the end user a significant long term savings when reconfiguring products in the field.
- High pressure tops are available on all SideBar laminates at an extended lead time – please refer to model # for availability and pricing.
- Global laminate and seating products are in compliance with stringent emission guidelines set out by UL/Greenguard Environmental Institute under the standards for low emitting products and materials. www.greenguard.org
- **Level 3 Certified**

CONSTRUCTION

- Tops are 1” thick, available in a variety of edge details
- All finishes feature edging in matching color (i.e. wood grain surfaces feature edging with matching printed wood grain)
- High pressure tops are available in all SideBar laminate finishes at an extended lead time. Please see model # for availability and pricing
- Products specified with the high pressure laminate option are finished on the underside of the surface with a kraft paper backing.

DIVIDERS, FILLERS AND MODESTY PANELS

- 11/16” panels are finished with a matching edge
- Items feature pilot holes for attachment of hardware

STORAGE

- Tops of all storage units are 1” thick, available in a variety of edge details
- Drawer and open cavity heights are built on a common module of 13.5”. In open cavities, this height accommodates standard size binders.
- All lateral files feature a foolproof interlock device
- 75 lb. box – 150 lb. file drawer weight capacity with full height sides. Pencil tray included in box drawer.
- All storage is standard with handles unless otherwise noted
- All drawers are locking unless otherwise noted
- All shelves are fixed

CONSTRUCTION

- Constructed of 45 lb. density particleboard covered on both sides with high performance thermally fused laminate
- Levelling glides are standard on all floor units
- Premium full extension progressive ball bearing slides on file drawers and box drawers
- All drawer fronts are edge banded on all four sides

LEGS AND FEET

- Leg assemblies feature two tapered legs welded to a steel cross beam. Levelers are standard; casters not available.
- Levelers adjust up to 1”.
- Storage unit feet will coordinate with handle finish (brass handles will default to Black [BK] feet).
- If no handle selection is available, legs and feet are available in Silver (SI) or Black (BK)

LOCKS

- Locks are standard on all storage modules unless otherwise noted. Lock finish will coordinate with handle finish (brass handles will default to Black [BK] locks).

SHIPPING

- Most items are shipped assembled, 1 per carton, unless otherwise noted. Items are easy to assemble

1. SPECIFY MODEL NUMBER

2. SPECIFY FINISH

Top/Base/Door, Drawer and Cabinet Finishes:

ACJ	Absolute Acajou	HGT	Hayden Grey
ASN	Asian Night	QTM	Quartered Mahogany
AWC	Avant Cherry	SOG	Storm Grey
AWH	Avant Honey	TFW	Tiger Fruitwood
BLK	Black	TWL	Tiger Walnut
BRC	Brushed Cobalt	WHE	Walnut Heights
CMB	Clear Maple	WHC	White Chocolate
DES	Dark Espresso	WCR	Winter Cherry
DWT	Designer White	WGY	Willow Grey

Edge:

AB	Split color edge with Black Trim
AS	Split color edge with Silver Trim
A3	Standard edge
AR	Bicut edge

Legs:

Benching and Transition Desk Legs are available in Silver (SI) or Black (BK)

Feet:

Storage Feet are available in Silver (SI) or Black (BK)

3. SPECIFY OPTIONS

EDGE OPTIONS



A3 - square corner, standard edge



AR - square corner, bicut edge



AS - square corner, Silver



AB - square corner, Black

HANDLES

- Handles are standard on most drawers/storage modules. All other drawers, including mobile and hanging pedestals, can be ordered with a choice of nine handle options to be **factory installed**. Each handle is identified by the letters "HU", "HV", "HW", "HX", "HS", "HZ", "HO", "HQ", and "HR". To specify a handle, please specify the code after the model number. To order a handle as an option, please specify the code when ordering. List Price is **\$37**.



HS Flared Silver



HV Square Edge Silver



HO Crescent Black



HW Flared Brass



HU Square Edge Black



HZ Dimpled Nickel



HX Flared Black



HQ Bar Silver



HR Bar Black

GROMMETS

- Optional Grommets available in standard worksurface locations (left, center or right) on benching units, transitional work tables and pedestal returns. Order as: **AG1, AG2 or AG3. Add \$69 for each cut-out.**
- Grommet hole dimensions are 3 1/4" wide x 1 7/8" deep.
- Grommets may be placed at non-standard locations. Order as: **AGS - Add \$69.** A drawing must be supplied with vertical and horizontal dimensions to the center of the cut-out (as in drawing above). Please refer to CUSTOM GROMMET LOCATION FORM in the back reference section.

Grommet hole dimensions

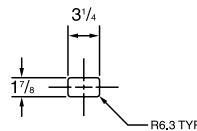

Grommet

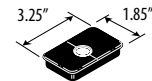

POWER BLOCK

- A Power block is a rectangular worksurface power/data module with one electrical duplex receptacle and two data (RJ45) receptacles. 9' black cord included. Power block dimensions are 3 1/2" deep x 6 1/2" wide x 2 3/4" high.
- Power block cutout dimensions are 2 3/4" deep x 6" wide.
- A Power block Cutout (model **PMSBDM**) are available in standard worksurface locations on benching units, transitional work tables and pedestal returns. Order as **E1, E2 or E3. Add \$69 for each cut-out.**
- To purchase a Power block, you must specify both the Power block cut-out location and the Power block model #. Order Power block separately as **PMSBDM, ADD \$261.**

Power block:

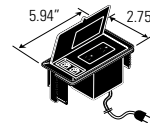

VILLA POWER BLOCK

- A Villa Power block (corded) is available in four options (see page 545 for Villa Corded details). Villa Power block (corded) dimensions vary by model. Villa cutout dimensions are 3" deep x 5 1/4" wide.
- Villa Power block Cutouts are available in standard worksurface locations on benching units, transitional work tables and pedestal returns. Order as: **V1, V2 or V3. Add \$69 for each cut-out.**
- To purchase a Villa Power block, you must specify both the Villa Power block cut-out location and the Villa Power block model #
- Order Villa Power block and Villa Grommet Cover separately, see page 545 for pricing and details.

Villa Power block:

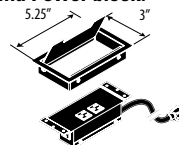

BENCHING UNITS

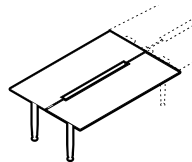

End of Run - 1 Leg

MODEL#	DIMENSIONS D x W x H	FREIGHT CLASS	WT/LBS.	CUBIC FT.	LIST PRICE	HP ADD
S4248CER	48 x 42 x 29.6	92.5	98	8.47	\$935	\$346
S4848CER	48 x 48 x 29.6	92.5	109	9.22	\$1004	\$395
S6048CER	48 x 60 x 29.6	85	131	10.48	\$1107	\$492
S7248CER	48 x 72 x 29.6	85	153	11.71	\$1229	\$576
S8448CER	48 x 84 x 29.6	85	175	12.96	\$1337	\$669
S4260CER	60 x 42 x 29.6	85	125	9.22	\$999	\$443
S4860CER	60 x 48 x 29.6	85	136	9.97	\$1052	\$492
S6060CER	60 x 60 x 29.6	85	158	10.96	\$1194	\$615
S7260CER	60 x 72 x 29.6	150	180	37.43	\$1332	\$738
S8460CER	60 x 84 x 29.6	85	202	13.47	\$1450	\$836

Back-to-back end of run benching unit consists of two tops with a center cutaway for wire pass thru and one SideBar leg assembly on one side. Support bars extend 3.25" below worksurface (one for each surface) and are shipped together in a separate carton. Leg assembly is shipped in a separate carton. **Not freestanding.**

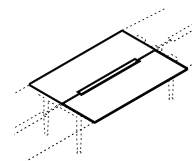

Middle - No Leg

S4248BE	48 x 42 x 4.25	70	81	5	\$645	\$346
S4848BE	48 x 48 x 4.25	70	97	5.76	\$709	\$395
S6048BE	48 x 60 x 4.25	70	114	7	\$832	\$395
S7248BE	48 x 72 x 4.25	70	141	8.26	\$940	\$395
S8448BE	48 x 84 x 4.25	70	158	9.50	\$1048	\$690
S4260BE	60 x 42 x 4.25	70	112	5	\$704	\$443
S4860BE	60 x 48 x 4.25	70	123	5.76	\$758	\$492
S6060BE	60 x 60 x 4.25	70	145	7	\$905	\$615
S7260BE	60 x 72 x 4.25	70	167	8.26	\$1038	\$738
S8460BE	60 x 84 x 4.25	70	189	9.50	\$1155	\$862

Back-to-back middle benching unit consists of two tops with a center cutaway for wire pass thru. Support bars extend 3.25" below worksurface (one for each surface) and are shipped together in a separate carton. **Not freestanding.**

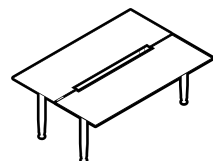

Standalone - 2 Legs

S4248CS	48 x 42 x 29.6	85	114	8.47	\$1194	\$346
S4848CS	48 x 48 x 29.6	85	125	9.22	\$1259	\$383
S6048CS	48 x 60 x 29.6	85	147	10.48	\$1367	\$477
S7248CS	48 x 72 x 29.6	85	169	11.71	\$1490	\$573
S8448CS	48 x 84 x 29.6	85	191	12.96	\$1592	\$669
S4260CS	60 x 42 x 29.6	70	142	9.22	\$1254	\$443
S4860CS	60 x 48 x 29.6	70	153	9.97	\$1314	\$492
S6060CS	60 x 60 x 29.6	70	175	10.96	\$1456	\$615
S7260CS	60 x 72 x 29.6	70	197	12.46	\$1592	\$738
S8460CS	60 x 84 x 29.6	70	219	13.47	\$1706	\$862

Back-to-back standalone benching units consist of two tops with a center cutaway for wire pass thru and two SideBar leg assemblies for freestanding applications. Support bars extend 3.25" below worksurface (one for each surface) and are shipped together in a separate carton. Leg assemblies are shipped in a separate carton. Freestanding.

Required Specifications

Top finish
Top/edge detail
Base finish

Optional Specifications

HP laminate
Additional grommet
Power/data management troughs

Accessories

Power block

STANDALONE STATIONS

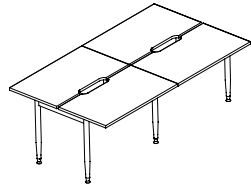

4 Pack

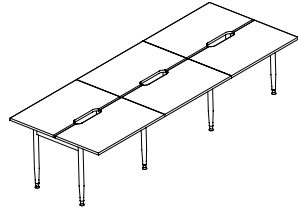

6 Pack

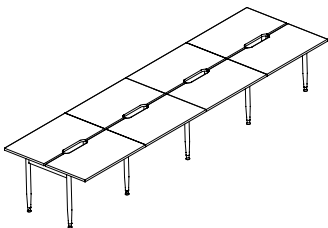

8 Pack

MODEL#	DIMENSIONS D x W x H	FREIGHT CLASS	WT/LBS.	CUBIC FT.	LIST PRICE	HP ADD
S4248CS4	48 x 84 x 29.6	250	198	90.30	\$2128	\$690
S4848CS4	48 x 96 x 29.6	150	454	96.41	\$2266	\$787
S6048CS4	48 x 120 x 29.6	150	542	108.6	\$2471	\$983
S7248CS4	48 x 144 x 29.6	150	630	120.9	\$2722	\$1181
S8448CS4	48 x 168 x 29.6	150	718	133.2	\$2939	\$1377
S4260CS4	60 x 84 x 29.6	150	520	98.98	\$2271	\$862
S4860CS4	60 x 96 x 29.6	150	564	105.0	\$2384	\$983
S6060CS4	60 x 120 x 29.6	150	652	117.3	\$2673	\$1229
S7260CS4	60 x 144 x 29.6	150	740	129.6	\$2939	\$1474
S8460CS4	60 x 168 x 29.6	150	828	141.9	\$3179	\$1721

Back-to-back standalone benching units consist of four tops with a center cutaway for wire pass thru and three SideBar leg assemblies for freestanding applications. Support bars extend 3.25" below worksurfaces (one for each surface) and are shipped together in a separate carton. Freestanding.

S4248CS6	48 x 126 x 29.6	300	303	160.7	\$3032	\$690
S4848CS6	48 x 144 x 29.6	300	336	173.6	\$3238	\$787
S6048CS6	48 x 180 x 29.6	250	402	199.4	\$3567	\$983
S7248CS6	48 x 216 x 29.6	250	468	225.2	\$3921	\$1181
S8448CS6	48 x 252 x 29.6	250	534	251.1	\$4250	\$1377
S4260CS6	60 x 126 x 29.6	250	385	172.8	\$3252	\$862
S4860CS6	60 x 144 x 29.6	250	418	185.8	\$3420	\$983
S6060CS6	60 x 180 x 29.6	250	484	211.6	\$3852	\$1229
S7260CS6	60 x 216 x 29.6	250	550	237.4	\$4255	\$1474
S8460CS6	60 x 252 x 29.6	250	616	263.2	\$4609	\$1721

Back-to-back standalone benching units consist of six tops with a center cutaway for wire pass thru and four SideBar leg assemblies for freestanding applications. Support bars extend 3.25" below worksurfaces (one for each surface) and are shipped together in a separate carton. Freestanding.

S4248CS8	48 x 168 x 29.6	300	410	307.8	\$3940	\$1377
S4848CS8	48 x 192 x 29.6	300	454	332.4	\$4211	\$1573
S6048CS8	48 x 240 x 29.6	300	542	379.1	\$4662	\$1966
S7248CS8	48 x 288 x 29.6	300	630	428.5	\$5120	\$2359
S8448CS8	48 x 336 x 29.6	300	718	475.2	\$5557	\$2752
S4260CS8	60 x 168 x 29.6	300	520	335.1	\$4231	\$1721
S4860CS8	60 x 192 x 29.6	300	564	357.1	\$4456	\$1966
S6060CS8	60 x 240 x 29.6	300	652	403.8	\$5031	\$2457
S7260CS8	60 x 288 x 29.6	300	740	453.3	\$5567	\$2948
S8460CS8	60 x 336 x 29.6	300	828	500	\$6042	\$3440

Back-to-back standalone benching units consist of eight tops with a center cutaway for wire pass thru and five SideBar leg assemblies for freestanding applications. Support bars extend 3.25" below worksurfaces (one for each surface) and are shipped together in a separate carton. Freestanding.

Required Specifications

Top finish
Top/edge detail
Base finish

Optional Specifications

HP laminate
Additional grommet
Power/data management troughs

Accessories

Power block

SINGLE SIDED STATIONS

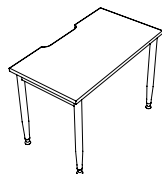

Single Sided Station

MODEL#	DIMENSIONS	FREIGHT CLASS	WT/LBS.	CUBIC FT.	LIST PRICE	HP ADD
D x W x H						
S4224SS1	24 x 42 x 29	250	53	22.16	\$959	\$174
S4824SS1	24 x 48 x 29	250	61	23.65	\$999	\$198
S6024SS1	24 x 60 x 29	250	71	26.95	\$1073	\$247
S7224SS1	24 x 72 x 29	250	82	29.94	\$1142	\$296
S8424SS1	24 x 84 x 29	250	92	32.93	\$1215	\$346
S4230SS1	30 x 42 x 29	250	67	22.46	\$1013	\$218
S4830SS1	30 x 48 x 29	250	75	24.25	\$1052	\$247
S6030SS1	30 x 60 x 29	250	86	27.69	\$1146	\$311
S7230SS1	30 x 72 x 29	250	99	30.69	\$1224	\$370
S8430SS1	30 x 84 x 29	250	110	33.68	\$1308	\$434

Single sided standalone benching units consist of one top with a center cutaway for wire pass thru and two SideBar leg assemblies for freestanding applications. A support bar extends 3.25" below worksurface and is shipped together in a separate carton. Freestanding.

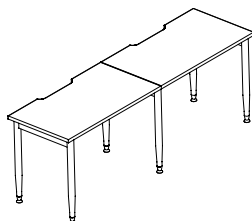

2 Single Sided Stations

S4224SS2	24 x 84 x 29	250	92	43.60	\$1646	\$346
S4824SS2	24 x 96 x 29	250	105	45.60	\$1730	\$395
S6024SS2	24 x 120 x 29	250	125	50	\$1872	\$492
S7224SS2	24 x 144 x 29	250	146	54	\$2015	\$591
S8424SS2	24 x 168 x 29	250	166	58	\$2157	\$690
S4230SS2	30 x 84 x 29	250	115	44	\$1750	\$434
S4830SS2	30 x 96 x 29	250	130	46.40	\$1829	\$492
S6030SS2	30 x 120 x 29	250	152	51	\$2015	\$615
S7230SS2	30 x 144 x 29	70	1075	55	\$2173	\$738
S8430SS2	30 x 168 x 29	250	198	59	\$2334	\$862

Single sided standalone benching units consist of two tops with a center cutaway for wire pass thru and three SideBar leg assemblies for freestanding applications. Support bars extend 3.25" below worksurfaces (one for each surface) and are shipped together in a separate carton. Freestanding.

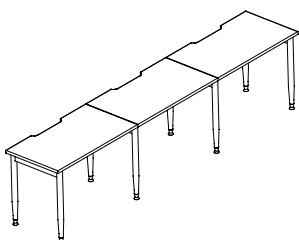

3 Single Sided Stations

S4224SS3	24 x 126 x 29	300	134	70	\$2334	\$518
S4824SS3	24 x 144 x 29	250	154	73.75	\$2462	\$591
S6024SS3	24 x 180 x 29	250	185	83.75	\$2678	\$738
S7224SS3	24 x 216 x 29	250	217	92.50	\$2890	\$886
S8424SS3	24 x 252 x 29	250	247	101.2	\$3105	\$1034
S4230SS3	30 x 126 x 29	250	167	71.25	\$2487	\$650
S4830SS3	30 x 144 x 29	250	192	75	\$2604	\$738
S6030SS3	30 x 180 x 29	250	226	85	\$2884	\$925
S7230SS3	30 x 216 x 29	250	261	93.75	\$3120	\$1107
S8430SS3	30 x 252 x 29	250	295	102.5	\$3361	\$1293

Single sided standalone benching units consist of three tops with a center cutaway for wire pass thru and four SideBar leg assemblies for freestanding applications. Support bars extend 3.25" below worksurfaces (one for each surface) and are shipped together in a separate carton. Freestanding.

Required Specifications

Top finish
Top/edge detail
Base finish

Optional Specifications

HP laminate
Additional grommet
Power/data management troughs

Accessories

Power block

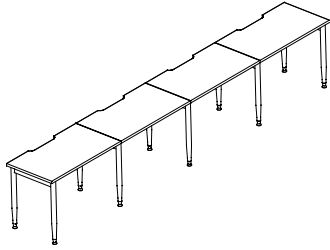

4 Single Sided Stations

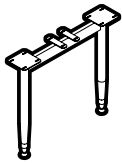

Legs

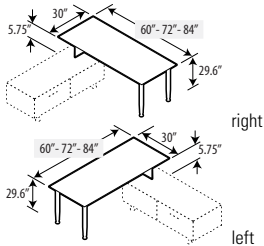

Transitional Work Tables

MODEL#	DIMENSIONS D x W x H	FREIGHT CLASS	WT/LBS.	CUBIC FT.	LIST PRICE	HP ADD
S4224SS4	24 x 168 x 29	300	172	109.2	\$3023	\$690
S4824SS4	24 x 192 x 29	300	198	116.7	\$3189	\$787
S6024SS4	24 x 240 x 29	300	239	128.7	\$3479	\$983
S7224SS4	24 x 288 x 29	300	281	140.7	\$3764	\$1181
S8424SS4	24 x 336 x 29	250	321	152.6	\$4048	\$1377
S4230SS4	30 x 168 x 29	300	217	110.7	\$3218	\$862
S4830SS4	30 x 192 x 29	250	247	118.2	\$3381	\$983
S6030SS4	30 x 240 x 29	250	292	130.2	\$3755	\$1229
S7230SS4	30 x 288 x 29	250	338	142.2	\$4063	\$1474
S8430SS4	30 x 336 x 29	250	383	155.6	\$4392	\$1721

Single sided standalone benching units consist of four tops with a center cutaway for wire pass thru and five SideBar leg assemblies for freestanding applications. Support bars extend 3.25" below worksurfaces (one for each surface) and are shipped together in a separate carton. Freestanding.

SXLEG48	6 x 26 x 28.6	150	18	3.60	\$262	n/a
SXLEG60	6 x 32 x 28.6	250	20	9	\$281	n/a

Leg assemblies for the structure of SideBar back-to-back tables. Used with SxxxxCER and SxxxxBE units to form extended runs of SideBar tables. Specify Black (BK) or Silver (SI). Tops sold separately.

- (1) SXLEG48 can be shared by four adjoining 24" d worksurfaces.
- (1) SXLEG60 can be shared by four adjoining 30" d worksurfaces.

S6030CLR	30 x 60 x 29.6	100	64	8	\$714	\$321
S7230CLR	30 x 72 x 29.6	100	74	9	\$783	\$370
S8430CLR	30 x 84 x 29.6	100	84	10	\$832	\$443
S6030CLL	30 x 60 x 29.6	100	64	8	\$714	\$321
S7230CLL	30 x 72 x 29.6	100	74	9	\$783	\$370
S8430CLL	30 x 84 x 29.6	100	84	10	\$832	\$443

Transitional table includes worksurface, SideBar leg assembly and laminate support base for use on **low credenzas**. Ships in two cartons.

Required Specifications

Top finish
Top/edge detail
Base finish

Optional Specifications

HP laminate
Additional grommet
Power/data management troughs

Accessories

Power block

TABLE DIVIDERS - LAMINATE

MODEL# DIMENSIONS FREIGHT CLASS WT/LBS. CUBIC FT. LIST PRICE HP ADD

D x W x H

S42FUL9	.69 x 42 x 6.75	70	16	.80	\$223	n/a
S48FUL9	.69 x 48 x 6.75	70	18	.90	\$242	n/a
S60FUL9	.69 x 60 x 6.75	70	21	1.10	\$266	n/a
S72FUL9	.69 x 72 x 6.75	70	23	1.20	\$287	n/a
S84FUL9	.69 x 84 x 6.75	70	26	1.40	\$311	n/a
S42FUL16	.69 x 42 x 13.5	70	19	1	\$266	n/a
S48FUL16	.69 x 48 x 13.5	70	22	1.20	\$287	n/a
S60FUL16	.69 x 60 x 13.5	70	27	1.40	\$306	n/a
S72FUL16	.69 x 72 x 13.5	70	32	1.60	\$331	n/a
S84FUL16	.69 x 84 x 13.5	70	37	1.80	\$350	n/a

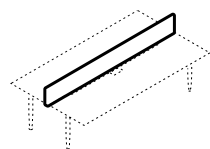

Full Width

Full width table dividers secure between **two back-to-back tables**, dividing space and providing varying levels of privacy. Specify the model # that corresponds to the overall surface width.

- SxxFUL9 dividers reach a finished height of 36.35", matching "Tier 2" units.
- SxxFUL16 dividers reach a finished height of 43.10", matching "Tier 2.5" units.

S42PAR9	.69 x 22 x 6.75	70	11	.50	\$188	n/a
S48PAR9	.69 x 28 x 6.75	70	12	.60	\$198	n/a
S60PAR9	.69 x 40 x 6.75	70	14	.80	\$218	n/a
S72PAR9	.69 x 52 x 6.75	100	16	2	\$242	n/a
S84PAR9	.69 x 64 x 6.75	70	19	1.10	\$262	n/a
S42PAR16	.69 x 22 x 13.5	70	14	.70	\$227	n/a
S48PAR16	.69 x 28 x 13.5	70	17	.80	\$242	n/a
S60PAR16	.69 x 40 x 13.5	70	22	1	\$262	n/a
S72PAR16	.69 x 52 x 13.5	70	26	1.20	\$281	n/a
S84PAR16	.69 x 64 x 13.5	70	14	.70	\$306	n/a

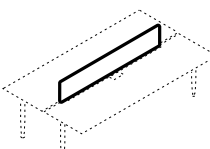

Partial Width

Partial width table dividers secure between **two back-to-back tables**, dividing space and providing varying levels of privacy. Partial width dividers are nominal and provide 10" of space on either side of the panel. Specify the model # that corresponds to the overall surface width.

- SxxPAR9 dividers reach a finished height of 36.35", matching "Tier 2" units.
- SxxPAR16 dividers reach a finished height of 43.10", matching "Tier 2.5" units.
- Gaps in between two adjacent panels can be filled with Separator Fillers and Shared Divider Storage Fillers. See page xx for details.

SS42FUL9	.69 x 42 x 25.75	85	29	2	\$350	n/a
SS48FUL9	.69 x 48 x 25.75	85	32	2.20	\$370	n/a
SS60FUL9	.69 x 60 x 25.75	85	36	2.80	\$414	n/a
SS72FUL9	.69 x 72 x 25.75	85	46	3.20	\$464	n/a
SS84FUL9	.69 x 84 x 25.75	85	53	3.80	\$503	n/a
SS42FUL16	.69 x 42 x 32.5	85	34	2.40	\$365	n/a
SS48FUL16	.69 x 48 x 32.5	85	38	2.60	\$404	n/a
SS60FUL16	.69 x 60 x 32.5	85	47	3.20	\$453	n/a
SS72FUL16	.69 x 72 x 32.5	85	55	3.80	\$507	n/a
SS84FUL16	.69 x 84 x 32.5	85	64	4.40	\$557	n/a

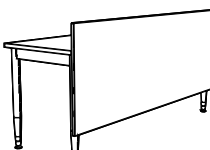

Full Width, for Single Sided Tables

Full width table dividers secure in front of **single sided tables**, dividing space and providing varying levels of privacy. Specify the model # that corresponds to the overall surface width.

- SSxxFUL9 dividers reach a finished height of 36.35", matching "Tier 2" units.
- SSxxFUL16 dividers reach a finished height of 43.10", matching "Tier 2.5" units.

Required Specifications

- Top finish
- Top/edge detail
- Base finish

Optional Specifications

- HP laminate
- Additional grommet
- Power/data management troughs

Accessories

- Power block

FILLERS

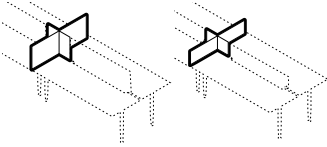

Middle Separating Filler

MODEL#	DIMENSIONS D x W x H	FREIGHT CLASS	WT./LBS.	CUBIC FT.	LIST PRICE	HP ADD
S2046S9	46 x 20 x 6.75	100	19	2.21	\$213	n/a
S2058S9	58 x 20 x 6.75	125	20	2.64	\$232	n/a
S2046S16	46 x 20 x 13.5	92.5	28	2.78	\$311	n/a
S2058S16	58 x 20 x 13.5	100	29	3.33	\$331	n/a

Middle separating fillers provide privacy and divide space between two users.

- To be used in conjunction with PARTIAL WIDTH table dividers
- SxxxxS9 dividers reach a finished height of 36.35", matching "Tier 2" units.
- SxxxxS16 dividers reach a finished height of 43.10", matching "Tier 2.5" units.

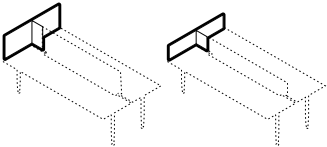

End Separating Filler

S1046E9	46 x 10 x 6.75	100	15	1.56	\$179	n/a
S1058E9	58 x 10 x 6.75	100	17	1.86	\$198	n/a
S1046E16	46 x 10 x 13.5	92.5	25	2.37	\$266	n/a
S1058E16	58 x 10 x 13.5	100	27	2.84	\$292	n/a

End separating fillers provide privacy at the end of a run of benching tables.

- To be used in conjunction with PARTIAL WIDTH table dividers
- SxxxxE9 dividers reach a finished height of 36.35", matching "Tier 2" units.
- SxxxxE16 dividers reach a finished height of 43.10", matching "Tier 2.5" units.

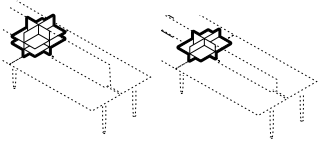

Middle Collator Filler

S2024C9	24 x 20 x 6.75	70	21	1.12	\$232	n/a
S2024C16	24 x 20 x 13.5	65	33	1.44	\$340	n/a

Middle collator fillers feature open storage between two users.

- To be used in conjunction with PARTIAL WIDTH table dividers
- SxxxxC9 dividers reach a finished height of 36.35", matching "Tier 2" units.
- SxxxxC16 dividers reach a finished height of 43.10", matching "Tier 2.5" units.

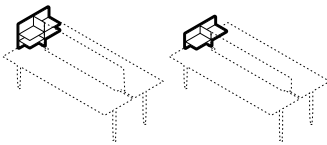

End Collator Filler

S1024EC9	24 x 10 x 6.75	70	14	.81	\$184	n/a
S1024EC16	24 x 10 x 13.5	70	22	1.30	\$257	n/a

End collator fillers feature open storage between two users.

- To be used in conjunction with PARTIAL WIDTH table dividers
- SxxxxEC9 dividers reach a finished height of 36.35", matching "Tier 2" units.
- SxxxxEC16 dividers reach a finished height of 43.10", matching "Tier 2.5" units.

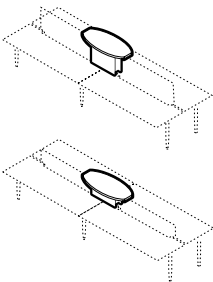

Transaction Top Filler

S3612T9	12 x 36 x 7.75	85	31	2.50	\$321	n/a
S3612T16	12 x 36 x 14.5	70	42	2	\$365	n/a

Transaction top filler feature an elevated worksurface between two users. Ships in two cartons.

- To be used in conjunction with PARTIAL WIDTH table dividers
- Product does not match any tier.
- S3612T9 dividers reach a finished height of 37.35".
- S3612T16 dividers reach a finished height of 44.10".

Required Specifications

Top finish
Top/edge detail (Transaction Shelf only)
Base finish

Optional Specifications

HP laminate (Transaction Top only)

FILLERS

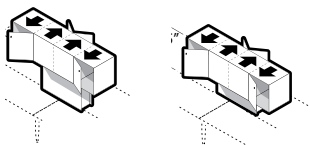

Shared Divider Storage Filler - Closed

MODEL#	DIMENSIONS D x W x H	FREIGHT CLASS	WT/LBS.	CUBIC FT.	LIST PRICE	HP ADD
S4813PCL	13.4 x 48 x 20.25	85	110	8.98	\$1249	n/a
S4813PCH	13.4 x 48 x 27	85	120	9.46	\$1337	n/a

Closed double sided storage units for users on opposite sides of back-to-back bench. Locking hinged doors. Openings will comfortably fit binders.

- To be used in conjunction with PARTIAL WIDTH table dividers
- S4813PCL storage fillers reach a finished height of 49.85", matches Tier 3 when placed on benching units.
- S4813PCH storage fillers reach a finished height of 56.6", matches Tier 3.5 when placed on benching units.

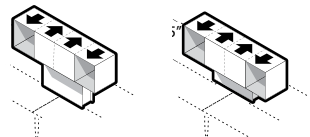

Shared Divider Storage Filler - Open

S4813POL	13.4 x 48 x 20.25	92.5	96	8.98	\$974	n/a
S4813POH	13.4 x 48 x 27	92.5	107	9.46	\$1068	n/a

Open double sided storage units for users on opposite sides of back-to-back bench. Ships in three cartons. Openings will comfortably fit binders.

- To be used in conjunction with PARTIAL WIDTH table dividers
- S4813POL storage fillers reach a finished height of 49.85", matches Tier 3 when placed on benching units.
- S4813POH storage fillers reach a finished height of 56.6", matches Tier 3.5 when placed on benching units.

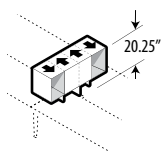

Shared Side Storage Filler - Open

S3613SSO	13.4 x 36 x 20.25	92.5	67	5.75	\$650	n/a
S4813SSO	13.4 x 48 x 20.25	100	77	7.75	\$729	n/a

Double sided storage units for users on both sides of a back-to-back bench. Openings will comfortably fit binders.

- To be used in conjunction with PARTIAL WIDTH table dividers
- Sxx13SSO side storage fillers reach a finished height of 49.85", matches Tier 3 when placed on benching units.

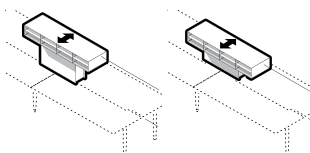

Shared Pigeon Hole Storage Filler

S4212GL	12 x 42 x 11.65	85	37	2.70	\$807	n/a
S4212GH	12 x 42 x 18.35	70	66	4.40	\$896	n/a

Pass thru pigeon hole storage for users on opposite sides of a back-to-back bench. Ships in three cartons.

- To be used in conjunction with PARTIAL WIDTH table dividers
- Product does not match any tier.
- S4212GL pigeon hole fillers reach a finished height of 41.25".
- S4212GH pigeon hole fillers reach a finished height of 47.95".

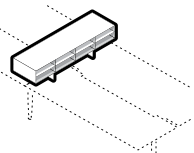

Shared Side Pigeon Hole Storage Filler

S4212SG	12 x 42 x 6.75	85	37	2.70	\$542	n/a
---------	----------------	----	----	------	--------------	-----

Pass thru pigeon hole storage for users on one side of a back-to-back bench.

- To be used in conjunction with PARTIAL WIDTH table dividers
- S4212SG reaches a finished height of 36.35", matches Tier 2 when placed on benching units.

Required Specifications

Top finish
Top/edge detail
Base finish

Door Fronts (Shared Divider Storage only)
Collator Finish (Pigeon Hole Storage only)
Lock Finish (Shared Divider w/Doors only)

RETURNS

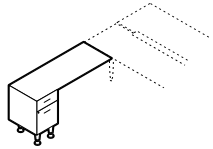

Pedestal Return - Left

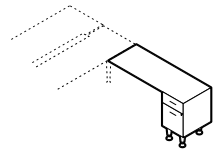

Pedestal Return - Right

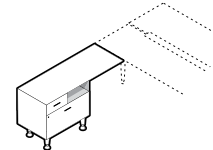

Mixed Storage Return - Left

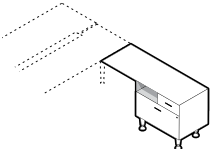

Mixed Storage Return - Right

MODEL#	DIMENSIONS D x W x H	FREIGHT CLASS	WT/LBS.	CUBIC FT.	LIST PRICE	HP ADD
S3620CZL	20 x 36 x 29.6	100	99	10.10	\$944	\$124
S4220CZL	20 x 42 x 29.6	100	103	10.50	\$965	\$149
S4820CZL	20 x 48 x 29.6	100	106	10.76	\$983	\$174
S5420CZL	20 x 54 x 29.6	100	110	11.10	\$999	\$198

S3624CZL	24 x 36 x 29.6	100	112	12	\$1004	\$149
S4224CZL	24 x 42 x 29.6	100	116	12.26	\$1028	\$174
S4824CZL	24 x 48 x 29.6	100	120	12.76	\$1048	\$198
S5424CZL	24 x 54 x 29.6	100	124	13	\$1068	\$223

Flush return with 16" w box/file pedestal on **LEFT** with handles. Lock secures both drawers. Ships in two cartons.

S3620CZR	20 x 36 x 29.6	100	99	10.10	\$944	\$124
S4220CZR	20 x 42 x 29.6	100	103	10.50	\$965	\$149
S4820CZR	20 x 48 x 29.6	100	106	10.76	\$983	\$174
S5420CZR	20 x 54 x 29.6	100	110	11.10	\$999	\$198

S3624CZR	24 x 36 x 29.6	100	112	12	\$1004	\$149
S4224CZR	24 x 42 x 29.6	100	116	12.26	\$1028	\$174
S4824CZR	24 x 48 x 29.6	100	120	12.76	\$1048	\$198
S5424CZR	24 x 54 x 29.6	100	124	13	\$1068	\$223

Flush return with 16" w box/file pedestal on **RIGHT** with handles. Lock secures both drawers. Ships in two cartons.

S4220CPL	20 x 42 x 29.6	100	140	16.40	\$1240	n/a
S4820CPL	20 x 48 x 29.6	100	144	16.76	\$1259	n/a
S5420CPL	20 x 54 x 29.6	100	148	17	\$1279	n/a
S6020CPL	20 x 60 x 29.6	100	151	17.30	\$1293	n/a

S4224CPL	24 x 42 x 29.6	100	158	19.26	\$1314	n/a
S4824CPL	24 x 48 x 29.6	100	162	19.60	\$1337	n/a
S5424CPL	24 x 54 x 29.6	100	166	20	\$1357	n/a
S6024CPL	24 x 60 x 29.6	100	170	20.40	\$1377	n/a

Flush return with 30" w mixed storage pedestal on **LEFT** with handles. Box drawer upper left, open shelf upper right and lateral file on bottom. Lock secures both drawers. Ships in two cartons.

S4220CPR	20 x 42 x 29.6	100	140	16.40	\$1240	n/a
S4820CPR	20 x 48 x 29.6	100	144	16.76	\$1259	n/a
S5420CPR	20 x 54 x 29.6	100	148	17	\$1279	n/a
S6020CPR	20 x 60 x 29.6	100	151	17.30	\$1293	n/a

S4224CPR	24 x 42 x 29.6	100	158	19.26	\$1314	n/a
S4824CPR	24 x 48 x 29.6	100	162	19.60	\$1337	n/a
S5424CPR	24 x 54 x 29.6	100	166	20	\$1357	n/a
S6024CPR	24 x 60 x 29.6	100	170	20.40	\$1377	n/a

Flush return with 30" w mixed storage pedestal on **RIGHT** with handles. Box drawer upper right, open shelf upper left and lateral file on bottom. Lock secures both drawers. Ships in two cartons.

Required Specifications

Top finish
Top/edge detail
Base finish
Handles, Drawer Fronts

Optional Specifications

HP laminate
Power block cut out grommet

Accessories

Power block

MODESTIES AND DIVIDERS

MODEL# DIMENSIONS FREIGHT CLASS WT/LBS. CUBIC FT. LIST PRICE HP ADD

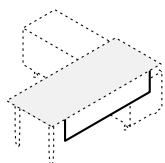

Modesty for Transitional Work Table

	D x W x H					
S60MPTC	.69 x 44 x 14	60	32	.80	\$179	n/a
S72MPTC	.69 x 56 x 14	60	38	1	\$202	n/a
S84MPTC	.69 x 68 x 14	60	45	1.10	\$218	n/a

Modesty attaches to Transitional Work Table. Modesty is inset .6875" (11/16") from the front edge and 8.25" from each side. Modesty clearance is 14.5" above finished floor. Specify the model # that corresponds to the overall surface width. Ships in two cartons.

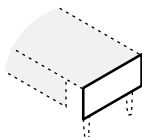

Flush End of Run Modesty Panel for Transitional Tables

S30SMP1	.69 x 30 x 21.25	70	13	.60	\$218	n/a
---------	------------------	----	----	-----	--------------	-----

Flush end of run modesty matches the height of the worksurface. End cap clearance is 8.25" above finished floor. Ships in two cartons.

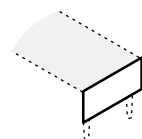

Flush End of Run Modesty Panel for Single Sided Benching Units

SS24SMP1	.69 x 24 x 21.25	70	21	1	\$159	n/a
SS30SMP1	.69 x 30 x 21.25	65	28	1.20	\$193	n/a

Flush end of run modesty matches the height of the worksurface. End cap clearance is 8.25" above finished floor. Ships in two cartons.

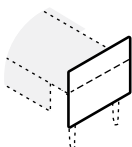

Partial Height End of Run Divider for Transitional Tables

S30SMP3	.69 x 30 x 25.75	70	19	.90	\$218	n/a
---------	------------------	----	----	-----	--------------	-----

Partial height end of run divider runs above and below the worksurface. Top of the panel is 6.75" above the worksurface. Clearance is 8.25" above finished floor. Ships in two cartons.

- S30SMP3 work table dividers reach a finished height of 36.35", matches Tier 2 when placed on work tables.

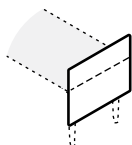

Partial Height End of Run Divider for Single Sided Benching Units

SS24SMP3	.69 x 24 x 25.75	70	25	1.20	\$198	n/a
SS30SMP3	.69 x 30 x 25.75	65	32	1.40	\$218	n/a

Partial height end of run divider runs above and below the worksurface. Top of the panel is 6.75" above the worksurface. Clearance is 8.25" above finished floor. Ships in two cartons.

- SS30SMP3 work table dividers reach a finished height of 36.35", matches Tier 2 when placed on work tables.

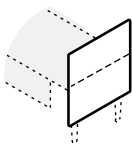

Full Height End of Run Divider for Transitional Tables

S30SMP2	.69 x 30 x 34.75	70	23	1.08	\$242	n/a
---------	------------------	----	----	------	--------------	-----

Full height end of run divider runs above and below the worksurface. Top of the panel is 13.5" above the worksurface. End cap clearance is 8.25" above finished floor. Ships in two cartons.

- S30SMP2 end of run dividers reach a finished height of 43.10", matches Tier 2.5 when placed on work tables.

Required Specifications

Modesty Panel / Divider Finish

MODESTIES AND DIVIDERS

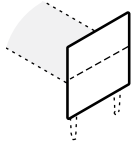

Full Height End of Run Divider for Single Sided Benching Units

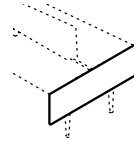

Flush End of Run Modesty

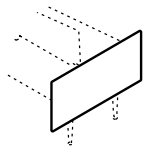

Partial Height End of Run Divider

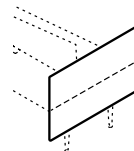

Full Height End of Run Divider

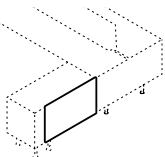

Flush Modesty for Returns

MODEL#	DIMENSIONS	FREIGHT CLASS	WT/LBS.	CUBIC FT.	LIST PRICE	HP ADD
--------	------------	---------------	---------	-----------	------------	--------

D x W x H

SS24SMP2	.69 x 24 x 32.5	70	28	1.40	\$184	n/a
SS30SMP2	.69 x 30 x 32.5	70	36	1.70	\$237	n/a

Full height end of run divider runs above and below the worksurface. Top of the panel is 13.5" above the worksurface. End cap clearance is 8.25" above finished floor. Ships in two cartons.

- SS30SMP2 end of run dividers reach a finished height of 43.10", matches Tier 2.5 when placed on work tables.

S48MPB1	.69 x 48 x 21.25	60	32	.90	\$202	n/a
S60MPB1	.69 x 60 x 21.25	60	42	1.10	\$208	n/a

Flush end of run modesty matches the height of the worksurface. End cap clearance is 8.25" above finished floor. Ships in two cartons.

- S48MPB1 to be used with 24"d back-to-back benching units.
- S60MPB1 to be used with 30"d back-to-back benching units.

S48MPB2	.69 x 48 x 25.75	60	37	1.16	\$247	n/a
S60MPB2	.69 x 60 x 25.75	60	47	1.40	\$253	n/a

Partial height end of run divider runs above and below the worksurface. Top of the panel is 6.75" above the worksurface. Clearance is 8.25" above finished floor. Ships in two cartons.

- S48MPB2 to be used with 24"d back-to-back benching units.
- S60MPB2 to be used with 30"d back-to-back benching units.
- SxxMPB2 end of run dividers reach a finished height of 36.35", matches Tier 2 when placed on benching units.

S48MPB5	.69 x 48 x 32.5	70	33	1.56	\$237	n/a
S60MPB5	.69 x 60 x 32.5	65	43	1.90	\$266	n/a

Full height end of run divider runs above and below the worksurface. Top of the panel is 13.5" above the worksurface. Clearance is 8.25" above finished floor. Ships in two cartons.

- S48MPB5 to be used with 24"d back-to-back benching units.
- S60MPB5 to be used with 30"d back-to-back benching units.
- SxxMPB5 end of run dividers reach a finished height of 43.10", matches Tier 2.5 when placed on benching units.

S36MPR1	.69 x 28.5 x 21.25	60	20	.60	\$188	n/a
S42MPR1	.69 x 34.5 x 21.25	60	21	.70	\$202	n/a
S48MPR1	.69 x 40.5 x 21.25	65	23	.80	\$218	n/a
S54MPR1	.69 x 46.5 x 21.25	65	24	.90	\$232	n/a
S60MPR1	.69 x 52.5 x 21.25	65	25	.90	\$247	n/a

Flush modesty panel for use on returns. Top of the modesty panel matches the height of the worksurface. Modesty panel is inset 7.5" from the pedestal end of the return. Modesty panel clearance is 8.5" above finished floor. Specify the model # that corresponds to the overall return width. Ships in two cartons.

Required Specifications

Modesty panel / divider finish

MODESTIES AND DIVIDERS

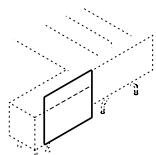

Partial Height Divider for Returns

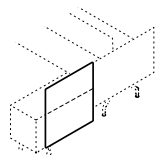

Full Height Divider for Returns



Mobile Pedestal

MODEL#	DIMENSIONS D x W x H	FREIGHT CLASS	WT/LBS.	CUBIC FT.	LIST PRICE	HP ADD
S36MPR5	.69 x 28.5 x 25.75	65	18	.76	\$179	n/a
S42MPR5	.69 x 34.5 x 25.75	65	21	.86	\$188	n/a
S48MPR5	.69 x 40.5 x 25.75	65	24	1.06	\$202	n/a
S54MPR5	.69 x 46.5 x 25.75	70	27	1.26	\$218	n/a
S60MPR5	.69 x 52.5 x 25.75	65	30	1.26	\$232	n/a

Partial height divider for use on returns. Modesty panel is inset 7.5" from the pedestal end of the return. Modesty panel clearance is 8.25" above finished floor. Specify the model # that corresponds to the overall return width. Ships in two cartons.

- SxxMPR5 pedestal return dividers reach a finished height of 36.35", matches Tier 2 when placed on returns.

S36MPR4	.69 x 28.5 x 32.5	70	22	1	\$202	n/a
S42MPR4	.69 x 34.5 x 32.5	70	25	1.16	\$218	n/a
S48MPR4	.69 x 40.5 x 32.5	70	28	1.32	\$232	n/a
S54MPR4	.69 x 46.5 x 32.5	70	31	1.48	\$247	n/a
S60MPR4	.69 x 52.5 x 32.5	70	34	1.66	\$262	n/a

Full height divider for use on returns. Modesty panel is inset 7.5" from the pedestal end of the return. Modesty panel clearance is 8.25" above finished floor. Specify the model # that corresponds to the overall return width. Ships in two cartons.

- SxxMPR4 end of run dividers reach a finished height of 43.10", matches Tier 2.5 when placed on returns.

S1619MP	19 x 16 x 25	85	76	6	\$743	n/a
S1623MP	23 x 16 x 25	92.5	82	7	\$772	n/a

Box/File drawers on fully progressive ball bearing slides, accommodate letter and legal size hanging files. Pedestal top is inset within side panels. Includes counterweight to prevent tipping. Drawers are locking. Handles are standard. Only front casters are locking.

- File drawer construction is for accommodating hanging files and NOT for stacking material on the drawer bottom.

Required Specifications

- Top finish / modesty + divider finish
- Drawer front finish (Mobile Pedestal only)
- Base finish (Mobile Pedestal only)
- Handles (Mobile Pedestal only)

STORAGE

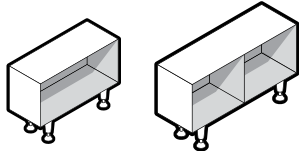

30" w

36" w

Low Bookcase

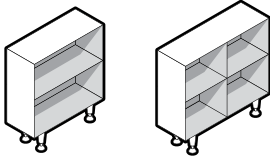

30" w

36" w

2 High Bookcase

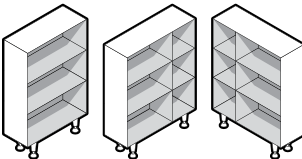

30" w

36" w - left

36" w - right

3 High Bookcase

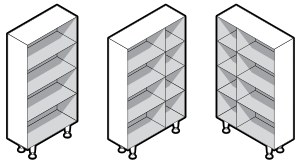

30" w

36" w - left

36" w - right

4 High Bookcase

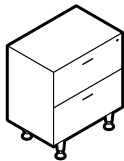

2 High Lateral File

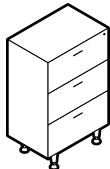

3 High Lateral File

MODEL#	DIMENSIONS	FREIGHT CLASS	WT/LBS.	CUBIC FT.	LIST PRICE	HP ADD
--------	------------	---------------	---------	-----------	------------	--------

D x W x H

S3012A0	12 x 30 x 22.85	125	49	7	\$464	n/a
S3612A0	12 x 36 x 22.85	125	61	8.25	\$537	n/a

Open bookcases accommodate binders in every cavity. One fixed shelf. 36" w units feature a fixed vertical divider.

S3012D0	12 x 30 x 36.35	125	77	10.50	\$640	n/a
S3612D0	12 x 36 x 36.35	125	94	12.50	\$743	n/a

Open bookcases accommodate binders in every cavity. Two fixed shelves. 36" w units feature a fixed vertical divider. Matches Tier 2.

S3012F0	12 x 30 x 49.85	125	102	14	\$772	n/a
S3612FOL	12 x 36 x 49.85	125	127	16.50	\$915	n/a
S3612FOR	12 x 36 x 49.85	125	127	16.50	\$915	n/a

Open bookcases accommodate binders in every cavity. Three fixed shelves. 36" w units feature a fixed vertical divider. Matches Tier 3.

S3012H0	12 x 30 x 63.35	125	129	17.50	\$915	n/a
S3612HOL	12 x 36 x 63.35	125	161	20.75	\$1103	n/a
S3612HOR	12 x 36 x 63.35	125	161	20.75	\$1103	n/a

Open bookcases accommodate binders in every cavity. Four fixed shelves. 36" w units feature a fixed vertical divider. Matches Tier 4.

S3020DZ	20 x 30 x 36.35	100	142	16.50	\$1254	n/a
S3024DZ	24 x 30 x 36.35	125	149	19.50	\$1323	n/a
S3620DZ	20 x 36 x 36.35	125	153	19.50	\$1357	n/a
S3624DZ	24 x 36 x 36.35	125	168	23.35	\$1431	n/a

Two file drawers. Handles are standard. Lock secures all drawers. Front-to-back and side-to-side letter/legal filing capability. Matches Tier 2.

- Lateral file drawer construction is for accommodating hanging files and NOT for stacking material on the drawer bottom.

S3020FZ	20 x 30 x 49.85	100	191	22	\$1543	n/a
S3024FZ	24 x 30 x 49.85	125	198	26	\$1622	n/a
S3620FZ	20 x 36 x 49.85	125	203	26	\$1672	n/a
S3624FZ	24 x 36 x 49.85	125	221	31	\$1760	n/a

Three file drawers. Handles are standard. Lock secures all drawers. Front-to-back and side-to-side letter/legal filing capability. Matches Tier 3.

- Lateral file drawer construction is for accommodating hanging files and NOT for stacking material on the drawer bottom.

Required Specifications

Top finish
Top/edge detail
Base finish
Drawer Front Finish (Units w/doors)

Handles
Leg Finish (Bookcases only)
Shelf Finish (Open Units)

STORAGE

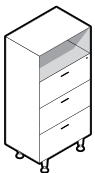

3 High Lateral File - Open

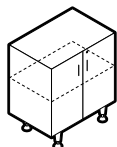

2 High Storage Cabinet

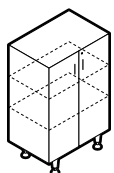

3 High Storage Cabinet

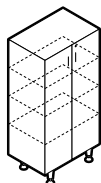

4 High Storage Cabinet

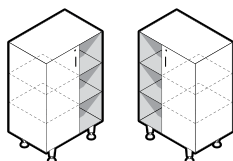

left right

3 High Mixed Storage Cabinet

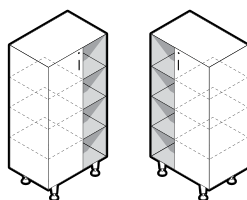

left right

4 High Mixed Storage Cabinet

MODEL#	DIMENSIONS D x W x H	FREIGHT CLASS	WT/LBS.	CUBIC FT.	LIST PRICE	HP ADD
S3020HZ	20 x 30 x 63.35	100	239	27.50	\$1898	n/a
S3024HZ	24 x 30 x 63.35	125	246	32.50	\$1990	n/a
S3620HZ	20 x 36 x 63.35	125	253	32.75	\$2055	n/a
S3624HZ	24 x 36 x 63.35	125	275	38.75	\$2157	n/a

Three file drawers. Handles are standard. Lock secures all drawers. Front-to-back and side-to-side letter/legal filing capability. Matches Tier 4.

- Lateral file drawer construction is for accommodating hanging files and NOT for stacking material on the drawer bottom.

S3020DX	20 x 30 x 36.35	125	122	16.50	\$974	n/a
S3024DX	24 x 30 x 36.35	125	139	19.50	\$1048	n/a
S3620DX	20 x 36 x 36.35	125	151	19.50	\$1142	n/a
S3624DX	24 x 36 x 36.35	125	173	23	\$1245	n/a

Laminate doors are standard. Handles are standard. Two fixed shelves. Standard with lock. Matches Tier 2.

S3020FX	20 x 30 x 49.85	125	167	22	\$1206	n/a
S3024FX	24 x 30 x 49.85	125	190	26	\$1302	n/a
S3620FX	20 x 36 x 49.85	100	209	23.75	\$1431	n/a
S3624FX	24 x 36 x 49.85	125	238	30.75	\$1564	n/a

Laminate doors are standard. Handles are standard. Three fixed shelves. Standard with lock. Matches Tier 3.

S3020HX	20 x 30 x 63.35	125	212	27.50	\$1446	n/a
S3024HX	24 x 30 x 63.35	125	241	32.50	\$1568	n/a
S3620HX	20 x 36 x 63.35	100	266	32.50	\$1760	n/a
S3624HX	24 x 36 x 63.35	125	303	38.50	\$1917	n/a

Laminate doors are standard. Handles are standard. Includes four fixed shelves. Standard with lock. Matches Tier 4.

S3020FXL	20 x 30 x 49.85	100	178	22	\$1215	n/a
S3024FXL	24 x 30 x 49.85	125	205	26	\$1332	n/a
S3020FXR	20 x 30 x 49.85	100	178	22	\$1215	n/a
S3024FXR	24 x 30 x 49.85	125	205	26	\$1332	n/a

Laminate door is standard. Handles are standard. Includes three fixed shelves. Specify left or right. Standard with lock. Matches Tier 3.

S3020HXL	20 x 30 x 63.35	100	226	27.50	\$1465	n/a
S3024HXL	24 x 30 x 63.35	100	261	32.50	\$1603	n/a
S3020HXR	20 x 30 x 63.35	100	226	27.50	\$1465	n/a
S3024HXR	24 x 30 x 63.35	100	261	32.50	\$1603	n/a

Laminate door is standard. Handles are standard. Includes four fixed shelves. Specify left or right. Standard with lock. Matches Tier 3.

Required Specifications

Top finish	Handles
Top/edge detail	
Base finish	
Door / Drawer Front Finish	

STORAGE

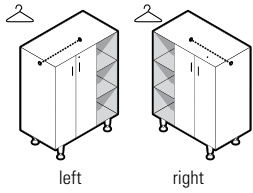

Wardrobe - Laminate Doors

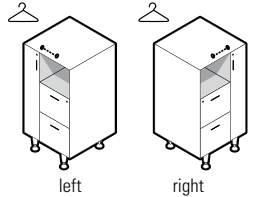

Wardrobe Tower - File/File

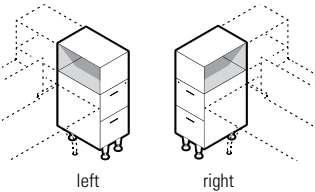

Side Towers - File/File

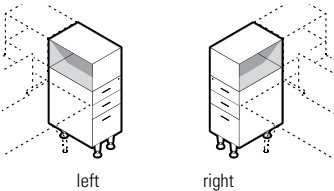

Side Towers - Box/Box/File

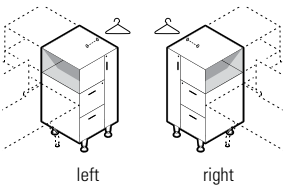

Wardrobe Side Tower - File/File

MODEL#	DIMENSIONS	FREIGHT CLASS	WT./LBS.	CUBIC FT.	LIST PRICE	HP ADD
--------	------------	---------------	----------	-----------	------------	--------

D x W x H

S3620FWL	20 x 36 x 49.85	125	178	26	\$1274	n/a
S3624FWL	24 x 36 x 49.85	125	203	30.75	\$1377	n/a
S3620FWR	20 x 36 x 49.85	125	178	26	\$1274	n/a
S3624FWR	24 x 36 x 49.85	125	203	30.75	\$1377	n/a

Laminate doors are standard. Handles are standard. Full length hanging rod included. Includes three fixed shelves. Specify left or right. Standard with lock. Matches Tier 3.

S2424FWL	24 x 24 x 49.85	100	189	21	\$1559	n/a
S2430FWL	30 x 24 x 49.85	100	221	26	\$1612	n/a
S2424FWR	24 x 24 x 49.85	100	189	21	\$1559	n/a
S2430FWR	30 x 24 x 49.85	100	221	26	\$1612	n/a

File/file drawers, open compartment, wardrobe cabinet with hanging rod, left or right handed. Handles are standard. Lock secures all drawers. Front-to-back and side-to-side letter/legal filing capability. Matches Tier 3.

- File drawer construction is for accommodating hanging files and NOT for stacking material on the drawer bottom.

S1624FZL	24 x 16 x 49.85	100	121	14.75	\$1151	n/a
S1630FZL	30 x 16 x 49.85	125	137	18	\$1234	n/a
S1624FZR	24 x 16 x 49.85	100	121	14.75	\$1151	n/a
S1630FZR	30 x 16 x 49.85	125	137	18	\$1234	n/a

File/file drawers, side facing open compartment, left or right handed. Handles are standard. Lock secures all drawers. Front-to-back and side-to-side letter/legal filing capability. Matches Tier 3.

- File drawer construction is for accommodating hanging files and NOT for stacking material on the drawer bottom.

S1624FYL	24 x 16 x 49.85	100	124	14.75	\$1298	n/a
S1630FYL	30 x 16 x 49.85	125	140	18	\$1387	n/a
S1624FYR	24 x 16 x 49.85	100	124	14.75	\$1298	n/a
S1630FYR	30 x 16 x 49.85	125	140	18	\$1387	n/a

Box/box/file drawers, side facing open compartment, left or right handed. Handles are standard. Lock secures all drawers. Front-to-back and side-to-side letter/legal filing capability. Matches Tier 3.

- File drawer construction is for accommodating hanging files and NOT for stacking material on the drawer bottom.

S2424FZL	24 x 24 x 49.85	100	171	21.25	\$1485	n/a
S2430FZL	30 x 24 x 49.85	125	195	25.75	\$1603	n/a
S2424FZR	24 x 24 x 49.85	100	171	21.25	\$1485	n/a
S2430FZR	30 x 24 x 49.85	125	195	25.75	\$1603	n/a

File/file drawers, side facing open compartment, wardrobe cabinet with hanging rod, left or right handed. Handles are standard. Lock secures all drawers. Front-to-back and side-to-side letter/legal filing capability. Matches Tier 3.

- File drawer construction is for accommodating hanging files and NOT for stacking material on the drawer bottom.

Required Specifications

Top finish
Top/edge detail
Base finish
Door / Drawer Front Finish

Handles

STORAGE

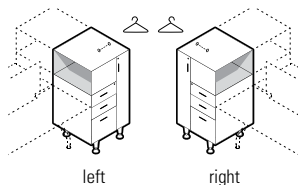

Wardrobe Side Tower - Box/Box/File

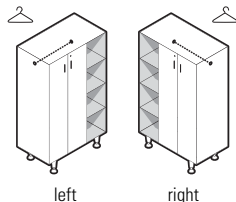

Wardrobe - Laminate Doors

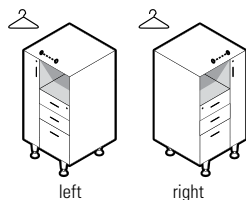

Wardrobe Tower - Box/Box/File

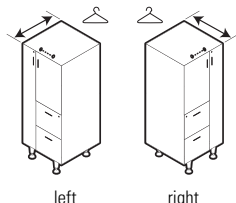

Wardrobe Tower - File/File

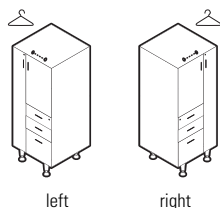

Wardrobe Tower - Box/Box/File

MODEL#	DIMENSIONS	FREIGHT CLASS	WT./LBS.	CUBIC FT.	LIST PRICE	HP ADD
--------	------------	---------------	----------	-----------	------------	--------

D x W x H

S2424FYL	24 x 24 x 49.85	100	174	21.30	\$1637	n/a
S2430FYL	30 x 24 x 49.85	125	198	25.75	\$1755	n/a
S2424FYR	24 x 24 x 49.85	100	174	21.30	\$1637	n/a
S2430FYR	30 x 24 x 49.85	125	198	25.75	\$1755	n/a

Box/box/file drawers, side facing open compartment, wardrobe cabinet with hanging rod, left or right handed. Handles are standard. Lock secures all drawers. Front-to-back and side-to-side letter/legal filing capability. Matches Tier 3.

- File drawer construction is for accommodating hanging files and NOT for stacking material on the drawer bottom.

S3620HWL	20 x 36 x 63.35	125	222	32.50	\$1519	n/a
S3624HWL	24 x 36 x 63.35	125	251	38.50	\$1642	n/a
S3620HWR	20 x 36 x 63.35	125	222	32.50	\$1519	n/a
S3624HWR	24 x 36 x 63.35	125	251	38.50	\$1642	n/a

Laminate doors are standard. Handles are standard. Full length hanging rod included. Includes four fixed shelves. Specify left or right. Standard with lock. Matches Tier 4.

S2424FVL	24 x 24 x 49.85	100	189	21	\$1686	n/a
S2430FVL	30 x 24 x 49.85	100	221	26	\$1736	n/a
S2424FVR	24 x 24 x 49.85	100	189	21	\$1686	n/a
S2430FVR	30 x 24 x 49.85	100	221	26	\$1736	n/a

Box/box/file drawers, open compartment, wardrobe cabinet with hanging rod, left or right handed. Handles are standard. Lock secures all drawers. Front-to-back and side-to-side letter/legal filing capability. Matches Tier 3.

- File drawer construction is for accommodating hanging files and NOT for stacking material on the drawer bottom.

S2424HWL	24 x 24 x 63.35	100	241	26.50	\$1883	n/a
S2430HWL	30 x 24 x 63.35	100	271	32.50	\$1932	n/a
S2424HWR	24 x 24 x 63.35	100	241	26.50	\$1932	n/a
S2430HWR	30 x 24 x 63.35	100	271	32.50	\$1932	n/a

File/file drawers, storage compartment with hinged doors, wardrobe cabinet with hanging rod, left or right handed. Handles are standard. Lock secures all drawers. Front-to-back and side-to-side letter/legal filing capability. Matches Tier 4.

- File drawer construction is for accommodating hanging files and NOT for stacking material on the drawer bottom.

S2424HVL	24 x 24 x 63.35	100	241	26.50	\$2010	n/a
S2430HVL	30 x 24 x 63.35	100	271	32.50	\$2055	n/a
S2424HVR	24 x 24 x 63.35	100	241	26.50	\$2010	n/a
S2430HVR	30 x 24 x 63.35	100	271	32.50	\$2055	n/a

Box/box/file drawers, storage compartment with hinged doors, wardrobe cabinet with hanging rod, left or right handed. Handles are standard. Lock secures all drawers. Front-to-back and side-to-side letter/legal filing capability. Matches Tier 4.

- File drawer construction is for accommodating hanging files and NOT for stacking material on the drawer bottom.

Required Specifications

Top finish	Handles
Top/edge detail	
Base finish	
Door / Drawer Front Finish	

STORAGE

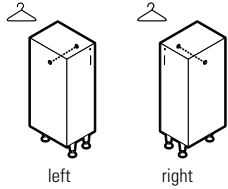

Wardrobe - Laminate Door

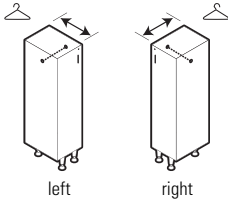

Wardrobe - Laminate Door

MODEL#	DIMENSIONS	FREIGHT CLASS	WT/LBS.	CUBIC FT.	LIST PRICE	HP ADD
--------	------------	---------------	---------	-----------	------------	--------

D x W x H

S1524FWL	24 x 15 x 49.85	125	108	13.75	\$876	n/a
S1530FWL	30 x 15 x 49.85	125	129	17	\$979	n/a
S1524FWR	24 x 15 x 49.85	125	108	13.75	\$876	n/a
S1530FWR	30 x 15 x 49.85	125	129	17	\$979	n/a

Laminate door is standard. Handles are standard. Full length hanging rod included. Specify left or right. Standard with lock. Matches Tier 3.

S1524HWL	24 x 15 x 63.35	125	135	17.25	\$1009	n/a
S1530HWL	30 x 15 x 63.35	125	159	21.25	\$1116	n/a
S1524HWR	24 x 15 x 63.35	125	135	17.25	\$1009	n/a
S1530HWR	30 x 15 x 63.35	125	159	21.25	\$1116	n/a

Laminate door is standard. Handles are standard. Full length hanging rod included. Specify left or right. Standard with lock. Matches Tier 4.

LOW CREDENZAS

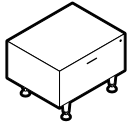

Low Credenza - Lateral Drawer

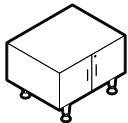

Low Credenza - Storage Cabinet

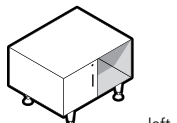

left

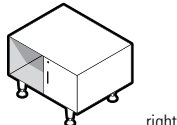

right

Low Credenza - Storage Compartment

S3020AZ	20 x 30 x 22.85	100	91	11	\$802	\$124
S3024AZ	24 x 30 x 22.85	125	101	12.75	\$856	\$124
S3620AZ	20 x 36 x 22.85	125	103	13	\$871	\$124
S3624AZ	24 x 36 x 22.85	125	116	15.25	\$930	\$149

One file drawer. Handles are standard. Lock secures all drawers. Front-to-back and side-to-side letter/legal filing capability.
 • Lateral file drawer construction is for accommodating hanging files and NOT for stacking material on the drawer bottom.

S3020AT	20 x 30 x 22.85	125	77	11	\$714	\$124
S3024AT	24 x 30 x 22.85	125	87	12.75	\$768	\$124
S3620AT	20 x 36 x 22.85	125	94	13	\$807	\$124
S3624AT	24 x 36 x 22.85	100	128	15.25	\$983	\$149

Laminate doors are standard. Handles are standard. Standard with lock.

S3020ATL	20 x 30 x 22.85	150	65	11	\$684	\$124
S3024ATL	24 x 30 x 22.85	125	91	12.75	\$743	\$124
S3620ATL	20 x 36 x 22.85	125	89	13	\$738	\$124
S3624ATL	24 x 36 x 22.85	100	123	15.25	\$915	\$149

S3020ATR	20 x 30 x 22.85	150	65	11	\$684	\$124
S3024ATR	24 x 30 x 22.85	125	91	12.75	\$743	\$124
S3620ATR	20 x 36 x 22.85	125	89	13	\$738	\$124
S3624ATR	24 x 36 x 22.85	100	123	15.25	\$915	\$149

Laminate door is standard on one side, open cavity on the other. Specify left or right handed. Standard with lock.

Required Specifications

Top finish
 Top/edge detail
 Base finish
 Door / Drawer Front Finish

Handles

Optional Specifications

HP Laminate (Low Credenzas only)

LOW CREDENZAS

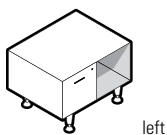

left

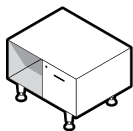

right

Low Credenza - File Drawer Storage

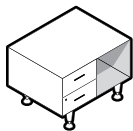

left

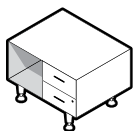

right

Low Credenza - Box/Box Storage

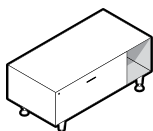

left

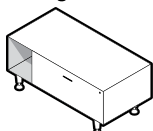

right

Low Credenza - Lateral Drawer

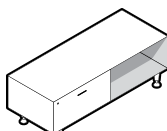

left

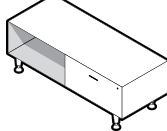

right

Low Credenza - Lateral Drawer

MODEL#	DIMENSIONS	FREIGHT CLASS	WT./LBS.	CUBIC FT.	LIST PRICE	HP ADD
--------	------------	---------------	----------	-----------	------------	--------

D x W x H

S3020ASL	20 x 30 x 22.85	125	84	11	\$748	\$124
S3024ASL	24 x 30 x 22.85	125	95	12.75	\$807	\$124
S3620ASL	20 x 36 x 22.85	125	93	13	\$797	\$124
S3624ASL	24 x 36 x 22.85	125	106	15.25	\$862	\$149

S3020ASR	20 x 30 x 22.85	125	84	11	\$748	\$124
S3024ASR	24 x 30 x 22.85	125	95	12.75	\$807	\$124
S3620ASR	20 x 36 x 22.85	125	93	13	\$797	\$124
S3624ASR	24 x 36 x 22.85	125	106	15.25	\$862	\$149

File drawer is standard on one side, open cavity on the other. Handles are standard. Specify left or right handed. Standard with lock. Front-to-back and side-to-side letter/legal filing capability.

- File drawer construction is for accommodating hanging files and NOT for stacking material on the drawer bottom.

S3020ARL	20 x 30 x 22.85	125	86	11	\$802	\$124
S3024ARL	24 x 30 x 22.85	125	98	12.75	\$862	\$124
S3620ARL	20 x 36 x 22.85	125	95	13	\$851	\$124
S3624ARL	24 x 36 x 22.85	125	108	15.25	\$915	\$149

S3020ARR	20 x 30 x 22.85	125	86	11	\$802	\$124
S3024ARR	24 x 30 x 22.85	125	98	12.75	\$862	\$124
S3620ARR	20 x 36 x 22.85	125	95	13	\$851	\$124
S3624ARR	24 x 36 x 22.85	125	108	15.25	\$915	\$149

Box/box drawer is standard on one side, open cavity on the other. Handles are standard. Specify left or right handed. Standard with lock. Front-to-back and side-to-side letter/legal filing capability.

S4220ASL	20 x 42 x 22.85	125	110	15	\$935	\$149
S4224ASL	24 x 42 x 22.85	125	123	17.50	\$1004	\$174
S4820ASL	20 x 48 x 22.85	125	121	17	\$1013	\$174
S4824ASL	24 x 48 x 22.85	125	136	20	\$1082	\$198

S4220ASR	20 x 42 x 22.85	125	110	15	\$935	\$149
S4224ASR	24 x 42 x 22.85	125	123	17.50	\$1004	\$174
S4820ASR	20 x 48 x 22.85	125	121	17	\$1013	\$174
S4824ASR	24 x 48 x 22.85	125	136	20	\$1082	\$198

Lateral file drawer is standard on one side, open cavity on the other. Handles are standard. Specify left or right handed. Standard with lock. Front-to-back and side-to-side letter/legal filing capability.

- 42" w cabinet has a 30" w lateral drawer.
- 48" w cabinet has a 36" w lateral drawer.
- Lateral file drawer construction is for accommodating hanging files and NOT for stacking material on the drawer bottom.

S6020ASL	20 x 60 x 22.85	125	138	21	\$1116	\$223
S6024ASL	24 x 60 x 22.85	125	156	24.75	\$1194	\$247
S7220ASL	20 x 72 x 22.85	125	159	20.75	\$1245	\$247
S7224ASL	24 x 72 x 22.85	125	179	25	\$1327	\$296

S6020ASR	20 x 60 x 22.85	125	138	21	\$1116	\$223
S6024ASR	24 x 60 x 22.85	125	156	24.75	\$1194	\$247
S7220ASR	20 x 72 x 22.85	125	159	20.75	\$1245	\$247
S7224ASR	24 x 72 x 22.85	125	179	25	\$1327	\$296

Lateral file drawer is standard on one side, open cavity on the other. Specify left or right handed. Standard with lock. Front-to-back and side-to-side letter/legal filing capability.

- 60" w cabinet has a 30" w lateral drawer.
- 72" w cabinet has a 36" w lateral drawer.
- Lateral file drawer construction is for accommodating hanging files and NOT for stacking material on the drawer bottom.

Required Specifications

Top finish
 Top/edge detail
 Base finish
 Door / Drawer Front Finish

Handles

Optional Specifications

HP laminate

LOW CREDENZAS

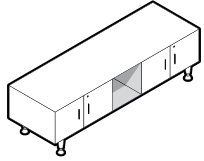

Low Credenza - Storage Cabinets

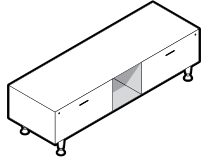

Low Credenza - Lateral Files

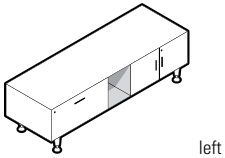

left

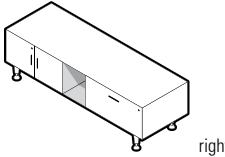

right

Low Credenza - Mixed Storage

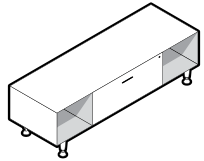

Low Credenza - Center Lateral File

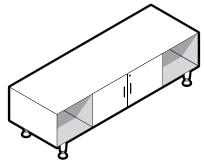

Low Credenza - Center Storage Cabinet

MODEL#	DIMENSIONS	FREIGHT CLASS	WT/LBS.	CUBIC FT.	LIST PRICE	HP ADD
--------	------------	---------------	---------	-----------	------------	--------

D x W x H

S7220AN	20 x 72 x 22.85	125	163	20.75	\$1342	\$247
S7224AN	24 x 72 x 22.85	125	189	25	\$1431	\$296
S8420AN	20 x 84 x 22.85	125	184	29	\$1377	\$296
S8424AN	24 x 84 x 22.85	125	211	34.50	\$1465	\$346

Laminate doors are standard on left and right, open cavity in the center. Handles are standard. Standard with locks.

- 72" w cabinet has two 30" w storage cabinets.
- 84" w cabinet has two 36" w storage cabinets.

S7220AP	20 x 72 x 22.85	100	183	20.75	\$1500	\$247
S7224AP	24 x 72 x 22.85	100	205	25	\$1588	\$296
S8420AP	20 x 84 x 22.85	125	205	29	\$1642	\$296
S8424AP	24 x 84 x 22.85	125	230	34.50	\$1755	\$346

Lateral files are standard on left and right, open cavity in the center. Handles are standard. Standard with locks.

- 72" w cabinet has two 30" w lateral drawers.
- 84" w cabinet has two 36" w lateral drawers.
- Lateral file drawer construction is for accommodating hanging files and NOT for stacking material on the drawer bottom.

S7220AML	20 x 72 x 22.85	100	170	20.75	\$1396	\$247
S7224AML	24 x 72 x 22.85	125	191	25	\$1485	\$296
S8420AML	20 x 84 x 22.85	125	191	29	\$1525	\$296
S8424AML	24 x 84 x 22.85	125	216	34.50	\$1633	\$346

S7220AMR	20 x 72 x 22.85	100	170	20.75	\$1396	\$247
S7224AMR	24 x 72 x 22.85	125	191	25	\$1485	\$296
S8420AMR	20 x 84 x 22.85	125	191	29	\$1525	\$296
S8424AMR	24 x 84 x 22.85	125	216	34.50	\$1633	\$346

Lateral file is standard on one side, laminate doors are standard on on side, open cavity in the center. Handles are standard. Specify left or right handed. Standard with locks.

- 72" w cabinet has one 30" w lateral drawer and one 30" w storage cabinet.
- 84" w cabinet has one 36" w lateral drawer and one 36" w storage cabinet.
- Lateral file drawer construction is for accommodating hanging files and NOT for stacking material on the drawer bottom.

S7220AS	20 x 72 x 22.85	125	162	20.75	\$1249	\$247
S7224AS	24 x 72 x 22.85	125	184	25	\$1342	\$296

Open cavities are standard on left and right, lateral file is standard in the center. Handles are standard. Standard with locks.

- 36" w lateral file
- Lateral file drawer construction is for accommodating hanging files and NOT for stacking material on the drawer bottom.

S7220AT	20 x 72 x 22.85	125	155	20.75	\$1155	\$247
S7224AT	24 x 72 x 22.85	125	180	24.50	\$1240	\$296

Open cavities are standard on left and right, laminate doors are standard in the center. Handles are standard. Standard with locks.

- 36" w storage cabinet

Required Specifications

Top finish
Top/edge detail
Base finish
Door / Drawer Front Finish

Handles

Optional Specifications

HP laminate

LOW CREDENZAS

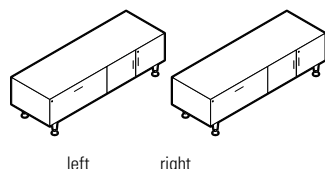

Low Credenza - Mixed Storage

MODEL#	DIMENSIONS D x W x H	FREIGHT CLASS	WT/LBS.	CUBIC FT.	LIST PRICE	HP ADD
S7220AKL	20 x 72 x 22.85	100	170	20.75	\$1431	\$247
S7224AKL	24 x 72 x 22.85	125	191	25	\$1519	\$296
S7220AKR	20 x 72 x 22.85	100	170	20.75	\$1431	\$247
S7224AKR	24 x 72 x 22.85	125	191	25	\$1519	\$296

Lateral file is standard on one side, laminate doors are standard on the other side. Handles are standard. Specify left or right handed. Standard with locks.

- 36" w storage cabinet
- 36" w lateral file
- Lateral file drawer construction is for accommodating hanging files and NOT for stacking material on the drawer bottom.

MEDIUM CREDENZAS

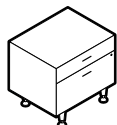

Medium Credenza - Box/File

S3020BZ	20 x 30 x 29.6	100	113	13.75	\$994	\$124
S3024BZ	24 x 30 x 29.6	125	126	16.25	\$1057	\$124
S3620BZ	20 x 36 x 29.6	125	128	16.25	\$1087	\$124
S3624BZ	24 x 36 x 29.6	100	142	16.75	\$1151	\$149

Wide box and lateral file. Handles are standard. Lock secures both drawers.

- Lateral file drawer construction is for accommodating hanging files and NOT for stacking material on the drawer bottom.

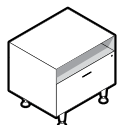

Medium Credenza w/Lateral File

S3020BY	20 x 30 x 29.6	100	116	13.75	\$944	\$124
S3024BY	24 x 30 x 29.6	100	131	16.25	\$1018	\$124
S3620BY	20 x 36 x 29.6	100	132	16.25	\$1038	\$124
S3624BY	24 x 36 x 29.6	100	149	16.75	\$1116	\$149

Open cavity and lateral file. Handles are standard. Standard with lock.

- Lateral file drawer construction is for accommodating hanging files and NOT for stacking material on the drawer bottom.

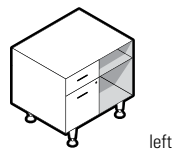

left

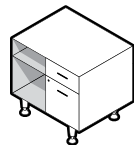

right

Medium Credenza - Box/File

S3020BRL	20 x 30 x 29.6	100	129	13.75	\$944	\$124
S3024BRL	24 x 30 x 29.6	100	134	16.25	\$1028	\$124
S3620BRL	20 x 36 x 29.6	100	131	16.25	\$1013	\$124
S3624BRL	24 x 36 x 29.6	100	149	16.75	\$1096	\$149

S3020BRR	20 x 30 x 29.6	100	129	13.75	\$944	\$124
S3024BRR	24 x 30 x 29.6	100	134	16.25	\$1028	\$124
S3620BRR	20 x 36 x 29.6	100	131	16.25	\$1013	\$124
S3624BRR	24 x 36 x 29.6	100	149	16.75	\$1096	\$149

Box/file is standard on one side, open cavity with one fixed shelf on the other. Handles are standard. Specify left or right handed. Standard with lock. Front-to-back and side-to-side letter/legal filing capability.

- File drawer construction is for accommodating hanging files and NOT for stacking material on the drawer bottom.

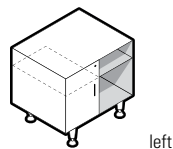

left

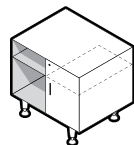

right

Medium Credenza - Storage Compartment

S3020BNL	20 x 30 x 29.6	100	113	13.75	\$837	\$124
S3024BNL	24 x 30 x 29.6	125	129	16.25	\$919	\$124
S3620BNL	20 x 36 x 29.6	125	116	16.25	\$905	\$124
S3624BNL	24 x 36 x 29.6	125	133	16.75	\$999	\$149

S3020BNR	20 x 30 x 29.6	100	113	13.75	\$837	\$124
S3024BNR	24 x 30 x 29.6	125	129	16.25	\$919	\$124
S3620BNR	20 x 36 x 29.6	125	116	16.25	\$905	\$124
S3624BNR	24 x 36 x 29.6	125	133	16.75	\$999	\$149

Laminate door is standard on one side, open cavity with one fixed shelf on the other. Handles are standard. Specify left or right handed. Standard with lock.

Required Specifications

Top finish
Top/edge detail
Base finish
Door / Drawer Front Finish

Handles

Optional Specifications

HP laminate

MEDIUM CREDENZAS

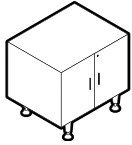

Medium Credenza - Storage Cabinet

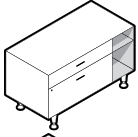

left

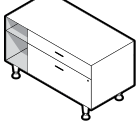

right

Medium Credenza - Box/Lateral File



left

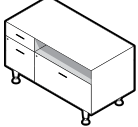

right

Medium Credenza - Mixed Drawers

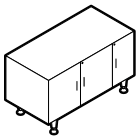

left

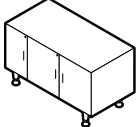

right

Medium Credenza - 3 Doors

MODEL#	DIMENSIONS D x W x H	FREIGHT CLASS	WT/LBS.	CUBIC FT.	LIST PRICE	HP ADD
S3020BT	20 x 30 x 29.6	125	106	13.50	\$753	\$124
S3024BT	24 x 30 x 29.6	125	122	16	\$935	\$124
S3620BT	20 x 36 x 29.6	100	131	16.25	\$1004	\$124
S3624BT	24 x 36 x 29.6	100	150	16.25	\$1091	\$149

Laminate doors are standard. Includes one fixed shelf. Handles are standard. Standard with lock.

S4220BSL	20 x 42 x 29.6	125	142	18.75	\$1176	\$149
S4224BSL	24 x 42 x 29.6	125	160	22	\$1254	\$174
S4820BSL	20 x 48 x 29.6	125	155	21.25	\$1274	\$174
S4824BSL	24 x 48 x 29.6	125	173	25	\$1357	\$198

S4220BSR	20 x 42 x 29.6	125	142	18.75	\$1176	\$149
S4224BSR	24 x 42 x 29.6	125	160	22	\$1254	\$174
S4820BSR	20 x 48 x 29.6	125	155	21.25	\$1274	\$174
S4824BSR	24 x 48 x 29.6	125	173	25	\$1357	\$198

Wide box and lateral file is standard on one side, open cavity with fixed shelf on the other. Handles are standard. Specify left or right handed. Standard with lock. Front-to-back and side-to-side letter/legal filing capability.

- 42" w credenza has a 30" w box/lateral file
- 48" w credenza has a 36" w box/lateral file
- Lateral file drawer construction is for accommodating hanging files and NOT for stacking material on the drawer bottom.

S4220BQL	20 x 42 x 29.6	100	165	18.75	\$1495	\$149
S4224BQL	24 x 42 x 29.6	100	184	22	\$1588	\$174
S4820BQL	20 x 48 x 29.6	100	179	21.25	\$1592	\$174
S4824BQL	24 x 48 x 29.6	100	184	22	\$1588	\$198

S4220BQR	20 x 42 x 29.6	100	165	18.75	\$1495	\$149
S4224BQR	24 x 42 x 29.6	100	184	22	\$1588	\$174
S4820BQR	20 x 48 x 29.6	100	179	21.25	\$1592	\$174
S4824BQR	24 x 48 x 29.6	100	184	22	\$1588	\$198

Box/file is standard on one side, open cavity and lateral file on the other side. Specify left or right handed. Handles are standard. Standard with locks. Front-to-back and side-to-side letter/legal filing capability.

- 42" w credenza has a 30" w lateral drawer
- 48" w credenza has a 36" w lateral drawer
- Lateral file drawer construction is for accommodating hanging files and NOT for stacking material on the drawer bottom.

S4220BTL	20 x 42 x 29.6	125	140	18.75	\$1142	\$149
S4224BTL	24 x 42 x 29.6	125	161	22.25	\$1240	\$174
S4820BTL	20 x 48 x 29.6	125	154	22.25	\$1229	\$174
S4824BTL	24 x 48 x 29.6	125	176	25.25	\$1337	\$198

S4220BTR	20 x 42 x 29.6	125	140	18.75	\$1142	\$149
S4224BTR	24 x 42 x 29.6	125	161	22.25	\$1240	\$174
S4820BTR	20 x 48 x 29.6	125	154	22.25	\$1229	\$174
S4824BTR	24 x 48 x 29.6	125	176	25.25	\$1337	\$198

Laminate doors are standard. Includes one fixed shelf. Specify left or right handed. Handles are standard. Standard with locks.

- 42" w credenza has a 30" w storage cabinet
- 48" w credenza has a 36" w storage cabinet

Required Specifications

Top finish
Top/edge detail
Base finish
Door / Drawer Front Finish

Handles

Optional Specifications

HP laminate

MEDIUM CREDENZAS

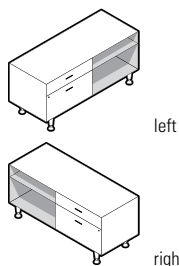

Medium Credenza - Box/Lateral

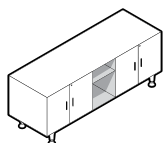

Medium Credenza - Storage Cabinets

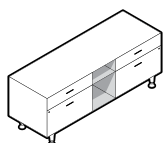

Medium Credenza - Box/Lateral Files

MODEL# DIMENSIONS FREIGHT CLASS WT/LBS. CUBIC FT. LIST PRICE HP ADD

D x W x H

S6020BRL	20 x 60 x 29.6	125	182	26.50	\$1411	\$223
S6024BRL	24 x 60 x 29.6	125	205	31	\$1504	\$247
S7220BRL	20 x 72 x 29.6	125	208	31.50	\$1573	\$247
S7224BRL	24 x 72 x 29.6	125	234	37	\$1676	\$296
S6020BRR	20 x 60 x 29.6	125	182	26.50	\$1411	\$223
S6024BRR	24 x 60 x 29.6	125	205	31	\$1504	\$247
S7220BRR	20 x 72 x 29.6	125	208	31.50	\$1573	\$247
S7224BRR	24 x 72 x 29.6	125	234	37	\$1676	\$296

Wide box and lateral file is standard on one side, open cavity with fixed shelf on the other. Handles are standard. Specify left or right handed. Standard with lock. Front-to-back and side-to-side letter/legal filing capability.

- 60" w cabinet has a 30" w box/file drawer.
- 72" w cabinet has a 36" w box/file drawer.
- Lateral file drawer construction is for accomodating hanging files and NOT for stacking material on the drawer bottom.

S7220BN	20 x 72 x 29.6	125	230	31.50	\$1646	\$247
S7224BN	24 x 72 x 29.6	125	265	37.50	\$1794	\$296
S8420BN	20 x 84 x 29.6	125	262	38.75	\$1814	\$296
S8424BN	24 x 84 x 29.6	100	300	37.50	\$1976	\$346

Laminate doors are standard on left and right, open cavity with fixed shelf in the center. Handles are standard. Standard with locks.

- 72" w cabinet has two 30" w storage cabinets.
- 84" w cabinet has two 36" w storage cabinets.

S7220BS	20 x 72 x 29.6	125	235	31.50	\$1902	\$247
S7224BS	24 x 72 x 29.6	125	260	37	\$2005	\$296
S8420BS	20 x 84 x 29.6	125	261	36.50	\$2089	\$296
S8424BS	24 x 84 x 29.6	125	290	37.25	\$2187	\$346

Wide box and lateral files are standard on left and right, open cavity with fixed shelf in the center. Handles are standard. Standard with locks.

- 72" w cabinet has two 30" w box/lateral file drawers.
- 84" w cabinet has two 36" w box/lateral file drawers.

BACK-TO-BACK CREDENZAS

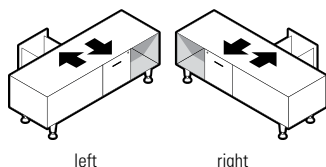

Back-to-Back Low Credenza - File Drawer

S6020ANL	20 x 60 x 22.85	100	172	21.25	\$1314	\$223
S7220ANL	20 x 72 x 22.85	125	190	25.25	\$1377	\$247
S6020ANR	20 x 60 x 22.85	100	172	21.25	\$1314	\$223
S7220ANR	20 x 72 x 22.85	125	190	25.25	\$1377	\$247

File drawers and open cavities are standard on either side of the credenza. For use between two adjacent workstations. Handles are standard. Standard with locks.

- 60" w cabinet has a 14" w open cavity.
- 72" w cabinet has a 20" w open cavity.
- File drawer construction is for accomodating hanging files and NOT for stacking material on the drawer bottom.

Required Specifications

Top finish
Top/edge detail
Base finish
Door / Drawer Front Finish

Handles

Optional Specifications

HP laminate

BACK-TO-BACK CREDENZAS

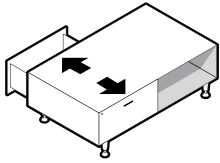

Back-to-Back Low, Deep Credenza - Lateral File

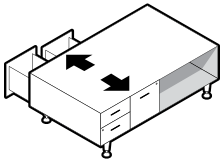

Back-to-Back Low, Deep Credenza - Mixed Drawers

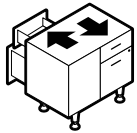

Back-to-Back Medium Credenza - Box/File

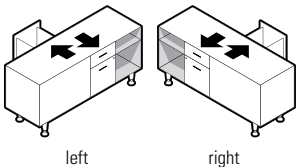

Back-to-Back Medium Credenza - Box/File

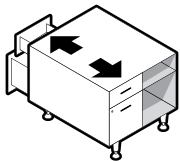

Back-to-Back Medium, Deep Credenza - Box/File

MODEL#	DIMENSIONS D x W x H	FREIGHT CLASS	WT/LBS.	CUBIC FT.	LIST PRICE	HP ADD
S6037AS	37.4 x 60 x 22.85	125	247	37.75	\$1681	\$395
S7237AS	37.4 x 72 x 22.85	125	285	44.75	\$1878	\$468

Lateral file drawers and open cavities are standard on either side of the credenza. For use between two adjacent workstations. Handles are standard. Standard with locks.

- 60" w credenza has a 30" w lateral drawer.
- 72" w credenza has a 36" w lateral drawer.
- Lateral file drawer construction is for accomodating hanging files and NOT for stacking material on the drawer bottom.

S6037AQ	37.4 x 60 x 22.85	125	281	37.75	\$2031	\$395
S7237AQ	37.4 x 72 x 22.85	125	314	44.75	\$2168	\$468

Box/File, file drawers and open cavities are standard on either side of the credenza. For use between two adjacent workstations. Handles are standard. Standard with locks.

- 60" w credenza has a 28" w open cavity.
- 72" w credenza has a 40" w open cavity.
- File drawer construction is for accomodating hanging files and NOT for stacking material on the drawer bottom.

S3320BU	20 x 33.25 x 29.6	92.5	148	14.75	\$1318	\$124
---------	-------------------	------	-----	-------	---------------	--------------

Box/file drawers standard on either side of the credenza. For use between two adjacent workstations. Handles are standard. Standard with locks.

- File drawer construction is for accomodating hanging files and NOT for stacking material on the drawer bottom.

S6020BPL	20 x 60 x 29.6	100	228	26.50	\$1750	\$223
S7220BPL	20 x 72 x 29.6	100	254	31.50	\$1844	\$247

S6020BPR	20 x 60 x 29.6	100	228	26.50	\$1750	\$223
S7220BPR	20 x 72 x 29.6	100	254	31.50	\$1844	\$247

Box/file drawers and open cavities with one fixed shelf are standard on either side of the credenza. For use between two adjacent workstations. Handles are standard. Standard with locks.

- File drawer construction is for accomodating hanging files and NOT for stacking material on the drawer bottom.

S3037BR	37.4 x 30 x 29.6	100	205	24.50	\$1549	\$198
---------	------------------	-----	-----	-------	---------------	--------------

Box/File drawers and open cavities with one fixed shelf are standard on either side of the credenza. For use between two adjacent workstations. Handles are standard. Standard with locks.

- File drawer construction is for accomodating hanging files and NOT for stacking material on the drawer bottom.

Required Specifications

Top finish
Top/edge detail
Base finish
Door / Drawer Front Finish

Handles

Optional Specifications

HP laminate

BACK-TO-BACK CRENZAS

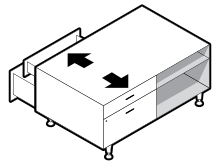

Back-to-Back Medium, Deep Credenza - Box/Lateral File

MODEL#	DIMENSIONS D x W x H	FREIGHT CLASS	WT/LBS.	CUBIC FT.	LIST PRICE	HP ADD
S6037BR	37.4 x 60 x 29.6	125	311	47	\$2177	\$383
S7237BR	37.4 x 72 x 29.6	125	358	56.25	\$2437	\$454

Wide box and lateral file drawers and open cavities with one fixed shelf are standard on either side of the credenza. For use between two adjacent workstations. Handles are standard. Standard with locks.

- 60" w credenza has 30" w box/file drawers.
- 72" w credenza has 36" w box/file drawers.
- File drawer construction is for accomodating hanging files and NOT for stacking material on the drawer bottom.

STACK-ON STORAGE

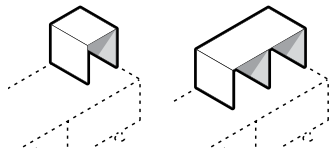

Stack-On Bookcases

S1214AO	14.3 x 12 x 13.5	92.5	23	2.20	\$184	n/a
S2414AO	14.3 x 24 x 13.5	100	37	4	\$281	n/a
S3014AO	14.3 x 30 x 13.5	100	41	5	\$311	n/a
S3614AO	14.3 x 36 x 13.5	125	46	5.90	\$340	n/a

Designed to be placed on top of credenzas. Open cavity. Unit rests directly on credenza top.

- Sxx14AO Stack-On bookcases add 1 tier when placed on any storage unit.

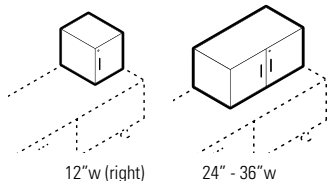

Stack-On Storage Cabinet

S1215ATL	15 x 12 x 13.5	92.5	26	2.30	\$257	n/a
S1215ATR	15 x 12 x 13.5	92.5	26	2.30	\$257	n/a

S2415AT	15 x 24 x 13.5	92.5	43	4.20	\$424	n/a
S3015AT	15 x 30 x 13.5	100	49	5.20	\$464	n/a
S3615AT	15 x 36 x 13.5	100	55	6.20	\$507	n/a

Designed to be placed on top of credenzas. Laminate doors are standard on one side, open cavity on the other side. Specify left or right handed. Handles are standard. Standard with locks. Unit rests directly on credenza top.

- Sxx15AT/ATL/ATR Stack-On storage cabinets add 1 tier when placed on any storage unit.

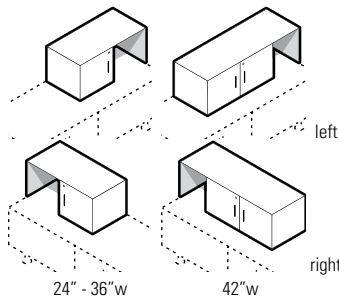

Stack-On Mixed Storage Cabinet

S2415ANL	15 x 24 x 13.5	100	40	4.20	\$356	n/a
S3015ANL	15 x 30 x 13.5	100	45	5.20	\$385	n/a
S3615ANL	15 x 36 x 13.5	100	51	6.20	\$424	n/a
S4215ANL	15 x 42 x 13.5	100	63	7.25	\$561	n/a

S2415ANR	15 x 24 x 13.5	100	40	4.20	\$356	n/a
S3015ANR	15 x 30 x 13.5	100	45	5.20	\$385	n/a
S3615ANR	15 x 36 x 13.5	100	51	6.20	\$424	n/a
S4215ANR	15 x 42 x 13.5	100	63	7.25	\$561	n/a

Designed to be placed on top of credenzas. Laminate doors are standard on one side, open cavity on the other side. Specify left or right handed. Handles are standard. Standard with locks. Unit rests directly on credenza top.

- Sxx15ANL/ANR Stack-On mixed storage cabinets add 1 tier when placed on any storage unit.

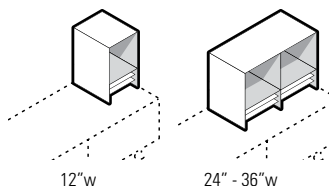

Stack-On Bookcase w/Collators

S1214B0	14.3 x 12 x 20.25	92.5	35	3.10	\$266	n/a
S2414B0	14.3 x 24 x 20.25	92.5	59	5.75	\$439	n/a
S3014B0	14.3 x 30 x 20.25	100	68	7	\$492	n/a
S3614B0	14.3 x 36 x 20.25	100	77	8.50	\$566	n/a

Designed to be placed on top credenzas. Open cavity with collator below. Unit rests directly on credenza top.

- Sxx14B0 Stack-On bookcases add 1.5 tiers when placed on any storage unit.

Required Specifications

Top finish
Top/edge detail
Base finish
Door/Drawer Front Finish (Storage Cabinets only)

Handles (Storage Cabinets only)
Collator Finish (Bookcase with Collator only)

Optional Specifications

HP laminate

STACK-ON STORAGE

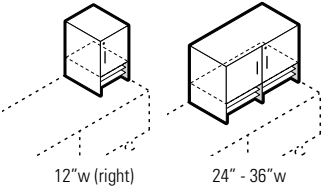

Stack-On Closed Storage Cabinet w/Collators

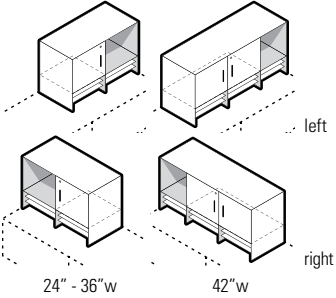

Stack-On Mixed Storage Cabinet w/Collators

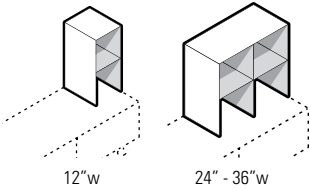

Stack-On Bookcases

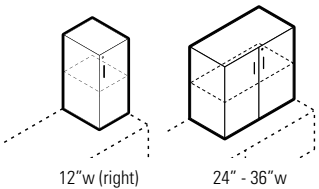

Stack-On Storage Cabinet

MODEL#	DIMENSIONS D x W x H	FREIGHT CLASS	WT/LBS.	CUBIC FT.	LIST PRICE	HP ADD
S1215BTL	15 x 12 x 20.25	92.5	38	3.30	\$335	n/a
S1215BTR	15 x 12 x 20.25	92.5	38	3.30	\$335	n/a
S2415BT	15 x 24 x 20.25	92.5	66	6	\$581	n/a
S3015BT	15 x 30 x 20.25	92.5	75	7.50	\$645	n/a
S3615BT	15 x 36 x 20.25	100	86	9	\$733	n/a

Designed to be placed on top of credenzas. Laminate doors are standard with collator below. For 12" w units specify left or right handed. Handles are standard. Standard with locks. Unit rests directly on credenza top.

- Sxx15BTL/BTR Stack-On storage cabinets add 1.5 tiers when placed on any storage unit.

S2415BNL	15 x 24 x 20.25	92.5	63	6	\$512	n/a
S3015BNL	15 x 30 x 20.25	100	72	7.50	\$566	n/a
S3615BNL	15 x 36 x 20.25	100	81	9	\$650	n/a
S4215BNL	15 x 42 x 20.25	100	100	10.25	\$811	n/a
S2415BNR	15 x 24 x 20.25	92.5	63	6	\$512	n/a
S3015BNR	15 x 30 x 20.25	100	72	7.50	\$566	n/a
S3615BNR	15 x 36 x 20.25	100	81	9	\$650	n/a
S4215BNR	15 x 42 x 20.25	100	100	10.25	\$811	n/a

Designed to be placed on top of credenzas. Laminate doors are standard one side, open cavity on the other side with collator below. Specify left or right handed. Handles are standard. Standard with locks. Unit rests directly on credenza top.

- Sxx15BNL/BNR Stack-On mixed storage cabinets add 1.5 tiers when placed on any storage unit.

S1214DO	14.3 x 12 x 27	92.5	41	4	\$301	n/a
S2414DO	14.3 x 24 x 27	100	68	7.50	\$473	n/a
S3014DO	14.3 x 30 x 27	100	76	9.25	\$518	n/a
S3614DO	14.3 x 36 x 27	125	85	11	\$576	n/a

Designed to be placed on top of credenzas. Open cavities with fixed shelf. Unit rests directly on credenza top.

- Sxx14DO Stack-On bookcases add 2 tiers when placed on any storage unit.

S1215DTL	15 x 12 x 27	92.5	47	4.20	\$395	n/a
S1215DTR	15 x 12 x 27	92.5	47	4.20	\$395	n/a
S2415DT	15 x 24 x 27	92.5	79	7.75	\$660	n/a
S3015DT	15 x 30 x 27	100	91	9.50	\$724	n/a
S3615DT	15 x 36 x 27	100	103	11.25	\$807	n/a

Designed to be placed on top of credenzas. Laminate doors are standard. Includes fixed shelf. For 12" w units specify left or right handed. Handles are standard. Standard with locks. Unit rests directly on credenza top.

- Sxx15DT/DTL/DTR Stack-On storage cabinets add 2 tiers when placed on any storage unit.

Required Specifications

Top finish
Top/edge detail
Base finish
Door/Drawer Front Finish (Storage Cabinets only)

Handles (Storage Cabinets only)
Collator Finish (Units with Collator only)

STACK-ON STORAGE

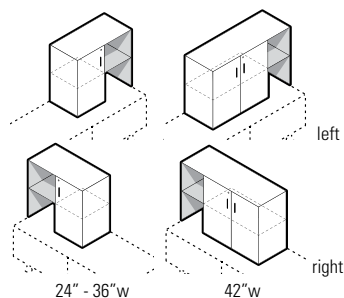

Stack-On Mixed Storage Cabinet

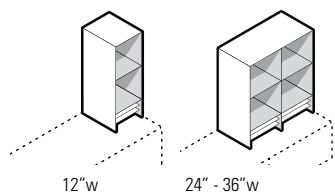

Stack-On Bookcase w/Collators

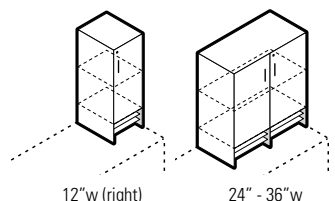

Stack-On Closed Storage Cabinet w/Collators

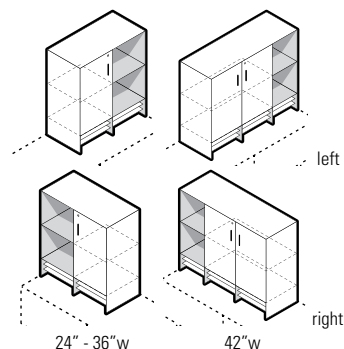

Stack-On Mixed Storage Cabinet w/Collators

MODEL#	DIMENSIONS	FREIGHT CLASS	WT/LBS.	CUBIC FT.	LIST PRICE	HP ADD
D x W x H						
S2415DNL	15 x 24 x 27	100	73	7.75	\$566	n/a
S3015DNL	15 x 30 x 27	100	83	9.50	\$621	n/a
S3615DNL	15 x 36 x 27	100	94	11.25	\$694	n/a
S4215DNL	15 x 42 x 27	100	117	13	\$890	n/a
S2415DNR	15 x 24 x 27	100	73	7.75	\$566	n/a
S3015DNR	15 x 30 x 27	100	83	9.50	\$621	n/a
S3615DNR	15 x 36 x 27	100	94	11.25	\$694	n/a
S4215DNR	15 x 42 x 27	100	117	13	\$890	n/a

Designed to be placed on top of credenzas. Laminate doors are standard on one side with one fixed shelf. Open cavity with one fixed shelf on the other side. Specify left or right handed. Handles are standard. Standard with locks. Unit rests directly on credenza top.

- Sxx15DNL/DNR Stack-On mixed storage cabinets add 2 tiers when placed on any storage unit.

S1214EO	14.3 x 12 x 33.75	92.5	53	5	\$389	n/a
S2414EO	14.3 x 24 x 33.75	100	90	9.25	\$645	n/a
S3014EO	14.3 x 30 x 33.75	100	102	11.25	\$714	n/a
S3614EO	14.3 x 36 x 33.75	100	115	13.25	\$811	n/a

Designed to be placed on top of credenzas. Open cavities with one fixed shelf and collator below. Unit rests directly on credenza top.

- Sxx14EO Stack-On bookcases add 2.5 tiers when placed on any storage unit.

S1215ETL	15 x 12 x 33.75	92.5	59	5.25	\$483	n/a
S1215ETR	15 x 12 x 33.75	92.5	59	5.25	\$483	n/a
S2415ET	15 x 24 x 33.75	92.5	102	9.50	\$827	n/a
S3015ET	15 x 30 x 33.75	100	117	11.75	\$915	n/a
S3615ET	15 x 36 x 33.75	100	133	14	\$1038	n/a

Designed to be placed on top of credenzas. Laminate doors are standard with one fixed shelf and collator below. For 12\"/>

- Sxx15ET/ETL/ETR Stack-On storage cabinets add 2.5 tiers when placed on any storage unit.

S2415ENL	15 x 24 x 33.75	92.5	96	9.50	\$733	n/a
S3015ENL	15 x 30 x 33.75	100	110	11.75	\$817	n/a
S3615ENL	15 x 36 x 33.75	100	124	14	\$925	n/a
S4215ENL	15 x 42 x 33.75	100	154	16	\$1155	n/a
S2415ENR	15 x 24 x 33.75	92.5	96	9.50	\$733	n/a
S3015ENR	15 x 30 x 33.75	100	110	11.75	\$817	n/a
S3615ENR	15 x 36 x 33.75	100	124	14	\$925	n/a
S4215ENR	15 x 42 x 33.75	100	154	16	\$1155	n/a

Designed to be placed on top of credenzas. Laminate doors are standard on one side with one fixed shelf. Open cavities on the other side, with one fixed shelf and collator below. Specify left or right handed. Handles are standard. Standard with locks. Unit rests directly on credenza top.

- Sxx15ENL/ENR Stack-On mixed storage cabinets add 2.5 tiers when placed on any storage unit.

Required Specifications

Top finish	Handles (Storage Cabinets only)
Top/edge detail	Collator Finish (Units with Collator only)
Base finish	
Door/Drawer Front Finish (Storage Cabinets only)	

STACK-ON STORAGE

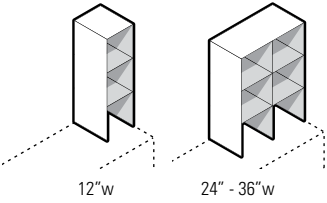

Stack-On Bookcases

MODEL#	DIMENSIONS D x W x H	FREIGHT CLASS	WT/LBS.	CUBIC FT.	LIST PRICE	HP ADD
S1214FO	14.3 x 12 x 40.5	100	59	6	\$419	n/a
S2414FO	14.3 x 24 x 40.5	100	98	10.75	\$655	n/a
S3014FO	14.3 x 30 x 40.5	100	110	13.25	\$718	n/a
S3614FO	14.3 x 36 x 40.5	125	123	15.75	\$797	n/a

Designed to be placed on top of credenzas. Open cavities with two fixed shelves. Unit rests directly on credenza top.

- Sxx14FO Stack-On bookcases add 3 tiers when placed on any storage unit.

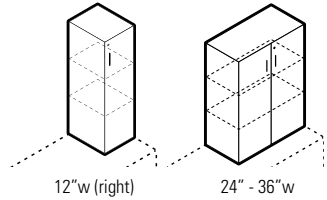

Stack-On Storage Cabinet

S1215FTL	15 x 12 x 40.5	92.5	68	6.25	\$537	n/a
S1215FTR	15 x 12 x 40.5	92.5	68	6.25	\$537	n/a
S2415FT	15 x 24 x 40.5	92.5	116	11.25	\$896	n/a
S3015FT	15 x 30 x 40.5	100	132	14	\$983	n/a
S3615FT	15 x 36 x 40.5	100	150	16.50	\$1096	n/a

Designed to be placed on top of credenzas. Laminate doors are standard, with two fixed shelves. Handles are standard. Standard with locks. Unit rests directly on credenza top.

- Sxx15FT/FTL/FTR Stack-On storage cabinets add 3 tiers when placed on any storage unit.

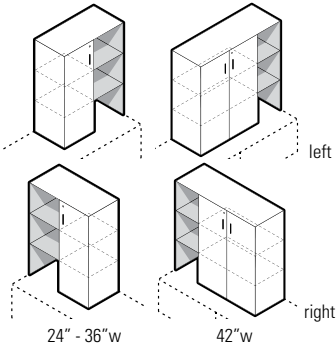

Stack-On Mixed Storage Cabinet

S2415FNL	15 x 24 x 40.5	100	107	11.25	\$777	n/a
S3015FNL	15 x 30 x 40.5	100	121	14	\$851	n/a
S3615FNL	15 x 36 x 40.5	100	137	16.50	\$949	n/a
S4215FNL	15 x 42 x 40.5	100	171	19	\$1215	n/a

Designed to be placed on top of credenzas. Laminate doors are standard on one side, with two fixed shelves. Open cavities on the other side, with two fixed shelves. Specify left or right handed. Handles are standard. Standard with locks. Unit rests directly on credenza top.

- Sxx15FNL/FNR Stack-On mixed storage cabinets add 3 tiers when placed on any storage unit.

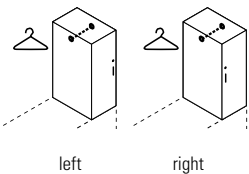

Stack-On Wardrobe Cabinet

S1224FTL	24 x 12 x 40.5	100	83	9.50	\$635	n/a
S1224FTR	24 x 12 x 40.5	100	83	9.50	\$635	n/a

Designed to be placed on top of credenzas. Laminate doors are standard. Includes hanging rod. Specify left or right handed. Handles are standard. Standard with locks. Unit rests directly on credenza top.

- S1224FTL/FTR Stack-On wardrobe cabinets add 3 tiers when placed on any storage unit.

Required Specifications

Top finish

Top/edge detail

Base finish

Door/Drawer Front Finish (Storage Cabinets only)

Handles (Storage Cabinets only)

STACK-ON STORAGE

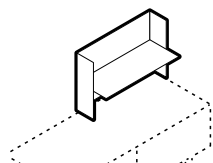

Stack-On Open Shelf - Single Sided

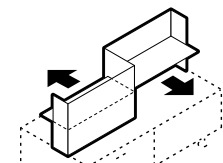

Stack-On Open Shelf - Back to Back

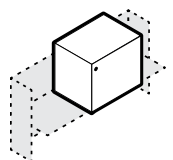

16.4-22.4" w (left)

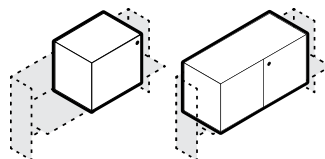

16.4-22.4" w (right)

27.9" - 33.9" w

Stack-On Closed Shelf Add-On Storage

MODEL# DIMENSIONS FREIGHT CLASS WT/LBS. CUBIC FT. LIST PRICE HP ADD

	D x W x H					
S3013BH	13.2 x 30 x 20.25	85	33	2.75	\$321	n/a
S3613BH	13.2 x 36 x 20.25	92.5	38	3.25	\$350	n/a
S4213BH	13.2 x 42 x 20.25	85	43	3.50	\$380	n/a
S4813BH	13.2 x 48 x 20.25	85	48	4	\$409	n/a

Credenza mounted open shelf. Unit rests directly on credenza top.

- Accepts **OPEN SHELF ADD-ON STORAGE**
- Sxx13BH Stack-On open shelves add 1.5 tiers when placed on any storage unit.

S3614BH2	14 x 36 x 20.25	150	45	8	\$374	n/a
S4214BH2	14 x 42 x 20.25	150	51	9	\$404	n/a
S4814BH2	14 x 48 x 20.25	150	56	10.50	\$424	n/a
S6014BH2	14 x 60 x 20.25	150	65	12.75	\$478	n/a
S7214BH2	14 x 72 x 20.25	150	75	15.25	\$537	n/a

Credenza mounted open shelf. For use with back-to-back shared credenzas. Unit rests directly on credenza top.

- Accepts **OPEN SHELF ADD-ON STORAGE**
- Sxx14BH2 Stack-On open shelves add 1.5 tiers when placed on any storage unit.

S1613AHL	13.2 x 16.4 x 14.76	100	26	2.90	\$271	n/a
S1913AHL	13.2 x 19.4 x 14.76	100	29	3.40	\$281	n/a
S2213AHL	13.2 x 22.4 x 14.76	125	32	4.10	\$306	n/a

S1613AHR	13.2 x 16.4 x 14.76	100	26	2.90	\$271	n/a
S1913AHR	13.2 x 19.4 x 14.76	100	29	3.40	\$281	n/a
S2213AHR	13.2 x 22.4 x 14.76	125	32	4.10	\$306	n/a

S2813AH	13.2 x 27.9 x 14.76	100	41	4.70	\$424	n/a
S3413AH	13.2 x 33.9 x 14.76	100	46	5.70	\$464	n/a

Add-on storage must be affixed to open shelf credenza hutches. For 16", 19" and 22" w units, specify left or right handed.

Unit is NOT freestanding.

- Sxx13AH/AHL/AHR add-on storage adds 1 tier when placed on stack-on open shelves.

HUTCHES

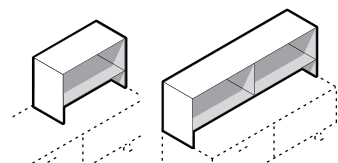

30" - 48" w

60" - 84" w

Low Hutch, Open

S3014BHO	14.3 x 30 x 20.25	125	55	7.25	\$356	n/a
S3614BHO	14.3 x 36 x 20.25	125	62	8.50	\$414	n/a
S4214BHO	14.3 x 42 x 20.25	125	69	10	\$453	n/a
S4814BHO	14.3 x 48 x 20.25	125	76	11.50	\$492	n/a
S6014BHO	14.3 x 60 x 20.25	125	95	14	\$606	n/a
S7214BHO	14.3 x 72 x 20.25	125	110	16.75	\$690	n/a
S8414BHO	14.3 x 84 x 20.25	125	124	19.50	\$768	n/a

Credenza mounted open hutch. Unit rests directly on credenza top.

- Sxx14BHO low hutches add 1.5 tiers when placed on any storage unit.

Required Specifications

Top finish

Top/edge detail

Base finish

Door / Drawer Front Finish

Lock Finish (Add-On Storage only)

HUTCHES

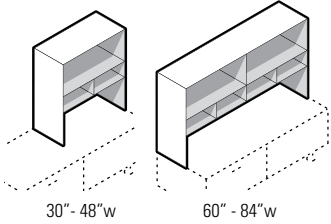

High Hutch, Open w/Pigeon Hole

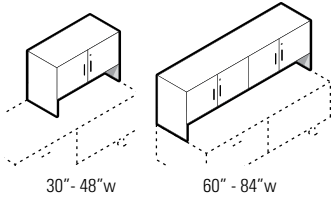

Low Hutch, Closed

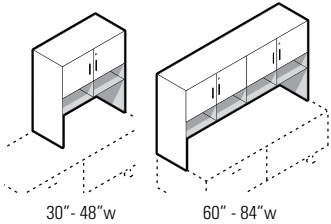

High Hutch, Closed w/Pigeon Hole

MODEL#	DIMENSIONS D x W x H	FREIGHT CLASS	WT/LBS.	CUBIC FT.	LIST PRICE	HP ADD
S3014EHO	14.3 x 30 x 33.75	125	85	11.50	\$581	n/a
S3614EHO	14.3 x 36 x 33.75	125	96	13.75	\$640	n/a
S4214EHO	14.3 x 42 x 33.75	125	107	16	\$699	n/a
S4814EHO	14.3 x 48 x 33.75	125	118	18	\$758	n/a
S6014EHO	14.3 x 60 x 33.75	125	148	22.25	\$965	n/a
S7214EHO	14.3 x 72 x 33.75	125	170	26.50	\$1082	n/a
S8414EHO	14.3 x 84 x 33.75	125	192	31	\$1199	n/a

Credenza mounted open hutch with pigeon hole storage. Unit rests directly on credenza top.

- Sxx14EHO high hutches add 2.5 tiers when placed on any storage unit.

S3015BHT	15 x 30 x 20.25	100	63	7.25	\$464	n/a
S3615BHT	15 x 36 x 20.25	100	71	8.50	\$531	n/a
S4215BHT	15 x 42 x 20.25	100	81	10	\$591	n/a
S4815BHT	15 x 48 x 20.25	125	89	11.50	\$630	n/a
S6015BHT	15 x 60 x 20.25	100	112	14	\$822	n/a
S7215BHT	15 x 72 x 20.25	125	130	16.75	\$930	n/a
S8415BHT	15 x 84 x 20.25	125	130	16.75	\$1034	n/a

Credenza mounted closed hutch. Handles are standard. Standard with locks. Unit rests directly on credenza top.

- Sxx15BHT low hutches add 1.5 tiers when placed on any storage unit.

S3015EHT	15 x 30 x 33.75	100	93	11.50	\$684	n/a
S3615EHT	15 x 36 x 33.75	125	105	13.75	\$758	n/a
S4215EHT	15 x 42 x 33.75	125	118	16	\$837	n/a
S4815EHT	15 x 48 x 33.75	125	131	18	\$896	n/a
S6015EHT	15 x 60 x 33.75	125	165	22.25	\$1176	n/a
S7215EHT	15 x 72 x 33.75	125	190	26.50	\$1323	n/a
S8415EHT	15 x 84 x 33.75	125	215	31	\$1470	n/a

Credenza mounted closed hutch with pigeon hole storage. Handles are standard. Standard with locks. Unit rests directly on credenza top.

- Sxx15EHT high hutches add 2.5 tiers when placed on any storage unit.

Required Specifications

Top finish	Handles
Top/edge detail	
Base finish	
Door / Drawer Front Finish	

CUSHIONS

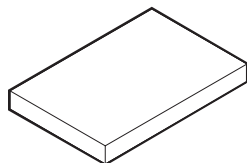

Cushion for Mobile Pedestals

MODEL#	DIMENSIONS	FREIGHT CLASS	WT/LBS.	CUBIC FT.	GRADE	LIST	GRADE	LIST
D x W x H								
CU1517	17 x 15 x 1.5	125	6	.90	1	\$105	7	\$301
					2	\$133	8	\$369
					3	\$155	9	\$422
					4	\$189	10	\$480
					5	\$235	11	\$600
					6	\$258	12	\$730
CU1520	20 x 15 x 1.5	70	1	1	1	\$113	7	\$308
					2	\$141	8	\$376
					3	\$162	9	\$429
					4	\$196	10	\$488
					5	\$244	11	\$608
					6	\$265	12	\$737

Cushion attaches with Velcro strips.

- CU1517 for use on S1619MP. CU1520 for use on S1623MP.

CU3020	20 x 30 x 1.5	150	6	1.30	1	\$168	7	\$364
					2	\$196	8	\$432
					3	\$218	9	\$485
					4	\$252	10	\$543
					5	\$299	11	\$664
					6	\$321	12	\$793
CU3620	20 x 36 x 1.5	150	7	1.60	1	\$189	7	\$386
					2	\$217	8	\$453
					3	\$239	9	\$505
					4	\$272	10	\$564
					5	\$320	11	\$684
					6	\$341	12	\$813
CU4220	20 x 42 x 1.5	70	1	1	1	\$214	7	\$410
					2	\$243	8	\$478
					3	\$264	9	\$531
					4	\$298	10	\$590
					5	\$345	11	\$709
					6	\$367	12	\$839
CU4820	20 x 48 x 1.5	70	1	1	1	\$233	7	\$576
					2	\$283	8	\$696
					3	\$322	9	\$788
					4	\$380	10	\$889
					5	\$463	11	\$1101
					6	\$501	12	\$1325
CU6020	20 x 60 x 1.5	70	1	1	1	\$325	7	\$668
					2	\$374	8	\$787
					3	\$414	9	\$880
					4	\$471	10	\$981
					5	\$555	11	\$1192
					6	\$593	12	\$1417
CU7220	20 x 72 x 1.5	70	1	1	1	\$385	7	\$727
					2	\$433	8	\$846
					3	\$472	9	\$939
					4	\$531	10	\$1041
					5	\$613	11	\$1251
					6	\$651	12	\$1476

Required Specifications

Fabric

CUSHIONS

MODEL#	DIMENSIONS	FREIGHT CLASS	WT/LBS.	CUBIC FT.	GRADE	LIST	GRADE	LIST
	D x W x H							
CU8420	20 x 84 x 1.5	70	1	1	1	\$416	7	\$759
					2	\$465	8	\$878
					3	\$504	9	\$970
					4	\$562	10	\$1072
					5	\$645	11	\$1283
					6	\$683	12	\$1507
CU3024	24 x 30 x 1.5	70	1	1	1	\$186	7	\$430
					2	\$221	8	\$515
					3	\$249	9	\$581
					4	\$290	10	\$655
					5	\$350	11	\$805
					6	\$376	12	\$965
CU3624	24 x 36 x 1.5	70	1	1	1	\$216	7	\$461
					2	\$251	8	\$545
					3	\$280	9	\$612
					4	\$321	10	\$685
					5	\$380	11	\$835
					6	\$407	12	\$995
CU4224	24 x 42 x 1.5	70	1	1	1	\$236	7	\$482
					2	\$271	8	\$567
					3	\$300	9	\$633
					4	\$341	10	\$706
					5	\$400	11	\$855
					6	\$428	12	\$1016
CU4824	24 x 48 x 1.5	70	1	1	1	\$255	7	\$647
					2	\$312	8	\$784
					3	\$356	9	\$888
					4	\$423	10	\$1006
					5	\$517	11	\$1247
					6	\$561	12	\$1503
CU6024	24 x 60 x 1.5	70	1	1	1	\$385	7	\$776
					2	\$440	8	\$913
					3	\$485	9	\$1017
					4	\$552	10	\$1135
					5	\$646	11	\$1376
					6	\$690	12	\$1632
CU7224	24 x 72 x 1.5	70	1	1	1	\$418	7	\$810
					2	\$473	8	\$946
					3	\$519	9	\$1051
					4	\$586	10	\$1169
					5	\$680	11	\$1410
					6	\$724	12	\$1666
CU8424	24 x 84 x 1.5	70	1	1	1	\$439	7	\$831
					2	\$495	8	\$968
					3	\$539	9	\$1072
					4	\$606	10	\$1189
					5	\$700	11	\$1430
					6	\$744	12	\$1687

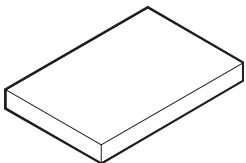

Cushion for Low Storage Cabinets

Cushion attaches with Velcro strips. For use on cabinets of coordinating size..

Required Specifications
Fabric

CUSHIONS

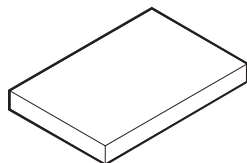

Cushion for Low Storage Cabinets

MODEL#	DIMENSIONS	FREIGHT CLASS	WT./LBS.	CUBIC FT.	GRADE	LIST	GRADE	LIST
	D x W x H							
CU3037	30 x 37 x 1.5	70	1	1	1	\$265	7	\$559
					2	\$307	8	\$662
					3	\$340	9	\$740
					4	\$391	10	\$828
					5	\$462	11	\$1009
					6	\$495	12	\$1200
CU3637	36 x 37 x 1.5	70	1	1	1	\$335	7	\$629
					2	\$377	8	\$732
					3	\$410	9	\$810
					4	\$461	10	\$898
					5	\$532	11	\$1079
					6	\$564	12	\$1270

Cushion attaches with Velcro strips. For use on back-to-back low, deep credenzas.

Required Specifications

Fabric

TACKBOARDS

MODEL# DIMENSIONS FREIGHT CLASS WT/LBS. CUBIC FT. FABRIC GRD. LIST PRICE

D x W x H

TACKBOARD Notes: Tackboards can be upholstered in all of the following fabrics:

Grade 1: Agate II, Hudson, Jenny, Quilt, Terrace, Urban, Waterfall

Grade 2: Crescent, Imprint, Lola, Match, Renewal, Replay, Silhouette

Grade 3: Anchorage, Brinx, Mariposa, Merge

Grade 4: Accent

Grade 5: Meander, Tracery, Universe

TACKBOARDS FOR DIVIDERS - SxxFUL9

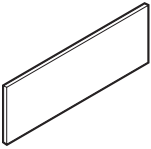

Tackboard for Dividers

STB4206	.62 x 42 x 6.5	150	2.28	.43	1	\$334
					2	\$376
					3	\$409
					4	\$460
					5	\$531

For use with **S42FUL9** divider. Covers entire side of divider. Velcro included for attachment.

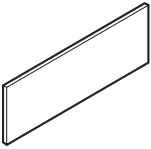

Tackboard for Dividers

STB4806	.62 x 48 x 6.5	150	2.60	.49	1	\$357
					2	\$399
					3	\$432
					4	\$483
					5	\$554

For use with **S48FUL9** divider. Covers entire side of divider. Velcro included for attachment.

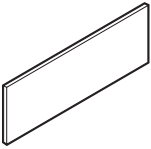

Tackboard for Dividers

STB6006	.62 x 60 x 6.5	150	3.25	.61	1	\$446
					2	\$502
					3	\$546
					4	\$613
					5	\$707

For use with **S60FUL9** divider. Covers entire side of divider. Velcro included for attachment.

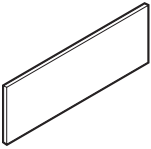

Tackboard for Dividers

STB7206	.62 x 72 x 6.5	150	3.90	.73	1	\$517
					2	\$578
					3	\$629
					4	\$703
					5	\$810

For use with **S72FUL9** divider. Covers entire side of divider. Velcro included for attachment.

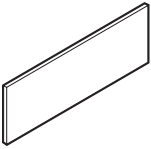

Tackboard for Dividers

STB8406	.62 x 84 x 6.5	150	4.55	.85	1	\$605
					2	\$675
					3	\$731
					4	\$813
					5	\$932

For use with **S84FUL9** divider. Covers entire side of divider. Velcro included for attachment.

Required Specifications

Fabric

TACKBOARDS FOR DIVIDERS - SxxFUL16

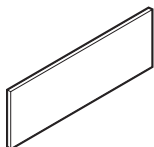

Tackboard for Dividers

MODEL#	DIMENSIONS D x W x H	FREIGHT CLASS	WT/LBS.	CUBIC FT.	FABRIC GRD.	LIST PRICE
STB4213	.62 x 42 x 13.25	150	4.64	.78	1	\$364
					2	\$407
					3	\$440
					4	\$490
					5	\$561

For use with **S42FUL16** divider. Covers entire side of divider. Velcro included for attachment.

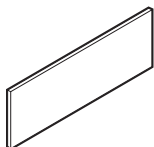

Tackboard for Dividers

STB4813	.62 x 48 x 13.25	125	5.30	.88	1	\$389
					2	\$431
					3	\$464
					4	\$514
					5	\$586

For use with **S48FUL16** divider. Covers entire side of divider. Velcro included for attachment.

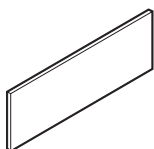

Tackboard for Dividers

STB6013	.62 x 60 x 13.25	125	6.63	1.09	1	\$488
					2	\$543
					3	\$589
					4	\$655
					5	\$749

For use with **S60FUL16** divider. Covers entire side of divider. Velcro included for attachment.

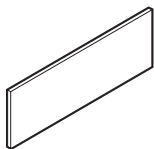

Tackboard for Dividers

STB7213	.62 x 72 x 13.25	125	7.95	1.31	1	\$562
					2	\$625
					3	\$675
					4	\$749
					5	\$855

For use with **S72FUL16** divider. Covers entire side of divider. Velcro included for attachment.

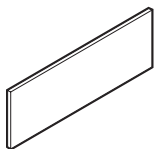

Tackboard for Dividers

STB8413	.62 x 84 x 13.25	125	9.28	1.52	1	\$655
					2	\$725
					3	\$780
					4	\$864
					5	\$981

For use with **S84FUL16** divider. Covers entire side of divider. Velcro included for attachment.

TACKBOARDS FOR DIVIDERS - SxxPAR9

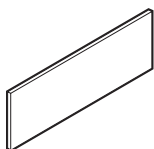

Tackboard for Dividers

STB2206	.62 x 22 x 6.5	70	1.19	.24	1	\$226
					2	\$254
					3	\$277
					4	\$309
					5	\$357

For use with **S42PAR9** divider. Covers entire side of divider. Velcro included for attachment.

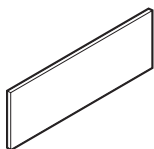

Tackboard for Dividers

STB2806	.62 x 28 x 6.5	70	1.52	.30	1	\$248
					2	\$277
					3	\$298
					4	\$332
					5	\$379

For use with **S48PAR9** divider. Covers entire side of divider. Velcro included for attachment.

Required Specifications

Fabric

S SIDEBAR

TACKBOARDS FOR DIVIDERS - SxxPAR9

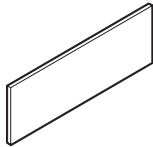

Tackboard for Dividers

MODEL#	DIMENSIONS D x W x H	FREIGHT CLASS	WT/LBS.	CUBIC FT.	FABRIC GRD.	LIST PRICE
STB4006	.62 x 40 x 6.5	150	2.17	.41	1	\$301
					2	\$343
					3	\$376
					4	\$427
					5	\$498

For use with **S60PAR9** divider. Covers entire side of divider. Velcro included for attachment.

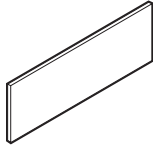

Tackboard for Dividers

STB5206	.62 x 52 x 6.5	150	2.82	.53	1	\$388
					2	\$435
					3	\$475
					4	\$533
					5	\$615

For use with **S72PAR9** divider. Covers entire side of divider. Velcro included for attachment.

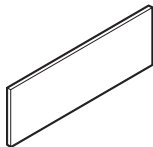

Tackboard for Dividers

STB6406	.62 x 64 x 6.5	150	3.47	.65	1	\$462
					2	\$518
					3	\$562
					4	\$629
					5	\$723

For use with **S84PAR9** divider. Covers entire side of divider. Velcro included for attachment.

TACKBOARDS FOR DIVIDERS - SxxPAR16

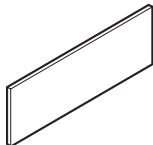

Tackboard for Dividers

STB2213	.62 x 22 x 13.25	150	2.43	.41	1	\$240
					2	\$261
					3	\$278
					4	\$302
					5	\$338

For use with **S42PAR16** divider. Covers entire side of divider. Velcro included for attachment.

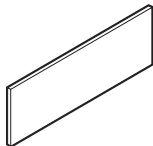

Tackboard for Dividers

STB2813	.62 x 28 x 13.25	150	3.09	.53	1	\$268
					2	\$297
					3	\$319
					4	\$353
					5	\$399

For use with **S48PAR16** divider. Covers entire side of divider. Velcro included for attachment.

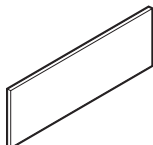

Tackboard for Dividers

STB4013	.62 x 40 x 13.25	150	4.42	.74	1	\$325
					2	\$368
					3	\$400
					4	\$451
					5	\$522

For use with **S60PAR16** divider. Covers entire side of divider. Velcro included for attachment.

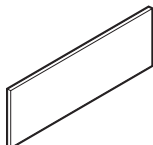

Tackboard for Dividers

STB5213	.62 x 52 x 13.25	125	5.74	.95	1	\$422
					2	\$469
					3	\$508
					4	\$567
					5	\$649

For use with **S72PAR16** divider. Covers entire side of divider. Velcro included for attachment.

Required Specifications

Fabric

TACKBOARDS FOR DIVIDERS - SxxPAR16

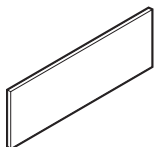

Tackboard for Dividers

MODEL#	DIMENSIONS D x W x H	FREIGHT CLASS	WT/LBS.	CUBIC FT.	FABRIC GRD.	LIST PRICE
STB6413	.62 x 64 x 13.25	125	7.07	1.16	1	\$504
					2	\$560
					3	\$605
					4	\$671
					5	\$765

For use with **S84PAR16** divider. Covers entire side of divider. Velcro included for attachment.

PARTIAL TACKBOARDS FOR DIVIDERS - SxxFUL9

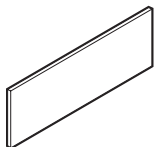

Tackboard for Dividers

STB2106	.62 x 21 x 6.5	70	1.14	.23	1	\$218
					2	\$239
					3	\$255
					4	\$281
					5	\$317

For use with **S42FUL9** divider. Covers **half** of divider. Velcro included for attachment.

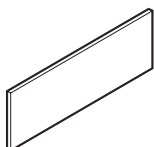

Tackboard for Dividers

STB2406	.62 x 24 x 6.5	70	1.30	.26	1	\$232
					2	\$261
					3	\$283
					4	\$317
					5	\$363

For use with **S48FUL9** divider. Covers **half** of divider. Velcro included for attachment.

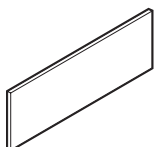

Tackboard for Dividers

STB3006	.62 x 30 x 6.5	70	1.63	.31	1	\$255
					2	\$284
					3	\$305
					4	\$339
					5	\$387

For use with **S60FUL9** divider. Covers **half** of divider. Velcro included for attachment.

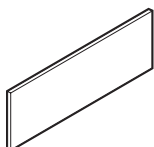

Tackboard for Dividers

STB3606	.62 x 36 x 6.5	70	1.95	.37	1	\$283
					2	\$318
					3	\$345
					4	\$387
					5	\$445

For use with **S72FUL9** divider. Covers **half** of divider. Velcro included for attachment.

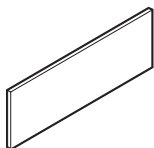

Tackboard for Dividers

STB4206	.62 x 42 x 6.5	150	2.28	.43	1	\$334
					2	\$376
					3	\$409
					4	\$460
					5	\$531

For use with **S84FUL9** divider. Covers **half** of divider. Velcro included for attachment.

Required Specifications

Fabric

S SIDEBAR

PARTIAL TACKBOARDS FOR DIVIDERS - SxxFUL16

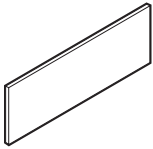

Tackboard for Dividers

MODEL#	DIMENSIONS D x W x H	FREIGHT CLASS	WT/LBS.	CUBIC FT.	FABRIC GRD.	LIST PRICE
STB2113	.62 x 21 x 13.25	150	2.32	.41	1	\$235
					2	\$257
					3	\$272
					4	\$298
					5	\$334

For use with **S42FUL16** divider. Covers **half** of divider. Velcro included for attachment.

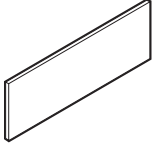

Tackboard for Dividers

STB2413	.62 x 24 x 13.25	250	2.65	.78	1	\$252
					2	\$281
					3	\$302
					4	\$336
					5	\$383

For use with **S48FUL16** divider. Covers **half** of divider. Velcro included for attachment.

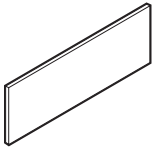

Tackboard for Dividers

STB3013	.62 x 30 x 13.25	150	3.31	.56	1	\$277
					2	\$304
					3	\$326
					4	\$360
					5	\$407

For use with **S60FUL16** divider. Covers **half** of divider. Velcro included for attachment.

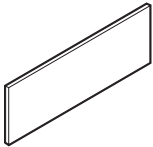

Tackboard for Dividers

STB3613	.62 x 36 x 13.25	150	3.98	.67	1	\$305
					2	\$340
					3	\$368
					4	\$409
					5	\$468

For use with **S72FUL16** divider. Covers **half** of divider. Velcro included for attachment.

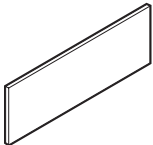

Tackboard for Dividers

STB4213	.62 x 42 x 13.25	150	4.64	.78	1	\$364
					2	\$407
					3	\$440
					4	\$490
					5	\$561

For use with **S84FUL16** divider. Covers **half** of divider. Velcro included for attachment.

PARTIAL TACKBOARDS FOR DIVIDERS - SxxPAR9

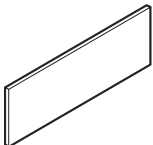

Tackboard for Dividers

STB1106	.62 x 11 x 6.5	70	.60	.13	1	\$176
					2	\$190
					3	\$200
					4	\$218
					5	\$242

For use with **S42PAR9** divider. Covers **half** of divider. Velcro included for attachment.

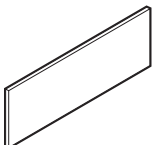

Tackboard for Dividers

STB1406	.62 x 14 x 6.5	70	.76	.16	1	\$192
					2	\$213
					3	\$229
					4	\$254
					5	\$290

For use with **S48PAR9** divider. Covers **half** of divider. Velcro included for attachment.

Required Specifications

Fabric

PARTIAL TACKBOARDS FOR DIVIDERS - SxxPAR9

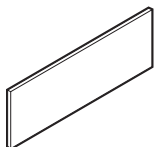

Tackboard for Dividers

MODEL#	DIMENSIONS D x W x H	FREIGHT CLASS	WT/LBS.	CUBIC FT.	FABRIC GRD.	LIST PRICE
STB2006	.62 x 20 x 6.5	70	1.08	.22	1	\$215
					2	\$235
					3	\$252
					4	\$278
					5	\$314

For use with **S60PAR9** divider. Covers **half** of divider. Velcro included for attachment.

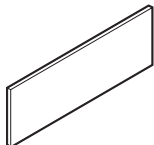

Tackboard for Dividers

STB2606	.62 x 26 x 6.5	70	1.41	.28	1	\$240
					2	\$268
					3	\$290
					4	\$324
					5	\$371

For use with **S72PAR9** divider. Covers **half** of divider. Velcro included for attachment.

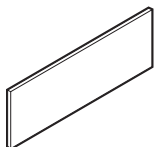

Tackboard for Dividers

STB3206	.62 x 32 x 6.5	70	1.73	.33	1	\$267
					2	\$302
					3	\$330
					4	\$371
					5	\$430

For use with **S84PAR9** divider. Covers **half** of divider. Velcro included for attachment.

PARTIAL TACKBOARDS FOR DIVIDERS - SxxPAR16

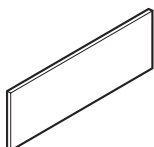

Tackboard for Dividers

STB1113	.62 x 11 x 13.25	70	1.21	.23	1	\$190
					2	\$204
					3	\$215
					4	\$232
					5	\$255

For use with **S42PAR16** divider. Covers **half** of divider. Velcro included for attachment.

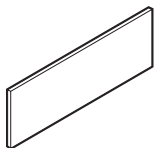

Tackboard for Dividers

STB1413	.62 x 14 x 13.25	70	1.55	.28	1	\$208
					2	\$228
					3	\$245
					4	\$269
					5	\$305

For use with **S48PAR16** divider. Covers **half** of divider. Velcro included for attachment.

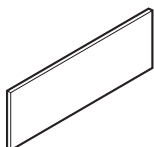

Tackboard for Dividers

STB2013	.62 x 20 x 13.25	150	2.21	.39	1	\$231
					2	\$252
					3	\$268
					4	\$294
					5	\$330

For use with **S60PAR16** divider. Covers **half** of divider. Velcro included for attachment.

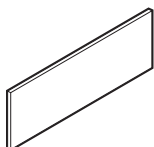

Tackboard for Dividers

STB2613	.62 x 26 x 13.25	150	2.87	.49	1	\$260
					2	\$288
					3	\$309
					4	\$343
					5	\$391

For use with **S72PAR16** divider. Covers **half** of divider. Velcro included for attachment.

Required Specifications

Fabric

PARTIAL TACKBOARDS FOR DIVIDERS - SxxPAR16

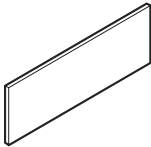

Tackboard for Dividers

MODEL#	DIMENSIONS D x W x H	FREIGHT CLASS	WT./LBS.	CUBIC FT.	FABRIC GRD.	LIST PRICE
STB3213	.62 x 32 x 13.25	150	3.53	.60	1	\$289
					2	\$324
					3	\$352
					4	\$393
					5	\$452

For use with **S84PAR16** divider. Covers **half** of divider. Velcro included for attachment.

TACKBOARDS FOR TRANSACTION TOP FILLERS

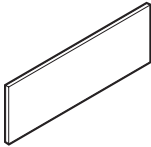

Tackboard for Transaction Top Filler

STB2306	.62 x 22.25 x 6.5	70	1.21	.24	1	\$226
					2	\$254
					3	\$277
					4	\$309
					5	\$357

For use with **S3612T9** transaction top filler. Covers entire area below transaction top. Velcro included for attachment.

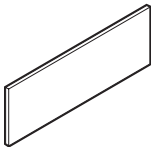

Tackboard for Transaction Top Filler

STB2313	.62 x 23 x 13.25	150	2.54	.44	1	\$248
					2	\$277
					3	\$298
					4	\$332
					5	\$379

For use with **S3612T16** transaction top filler. Covers entire area below transaction top. Velcro included for attachment.

TACKBOARDS FOR SHARED DIVIDER STORAGE FILLERS

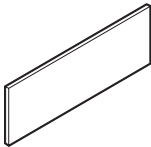

Tackboard for Shared Storage Filler

STB2306	.62 x 22.25 x 6.5	70	1.21	.24	1	\$226
					2	\$254
					3	\$277
					4	\$309
					5	\$357

Velcro included for attachment.

- Use with **S4813PCL/S4813POL** shared divider storage filler. Covers entire area below storage.
- Use with **S4813PCH/S4813POH** shared divider storage filler. Covers entire area below storage.
- Use with **S4212GL** shared pigeon hole storage filler. Covers entire area below pigeon hole storage.

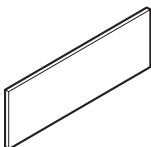

Tackboard for Shared Storage Filler

STB2313	.62 x 23 x 13.25	150	2.54	.44	1	\$248
					2	\$277
					3	\$298
					4	\$332
					5	\$379

Velcro included for attachment.

- Use with **S4813PCL/S4813POL** shared divider storage filler. Covers entire area on the back of the storage upper.
- Use with **S4813PCH/S4813POH** shared divider storage filler. Covers entire area on the back of the storage upper.
- Use with **S4212GH** shared pigeon hole storage filler. Covers entire area below pigeon hole storage.

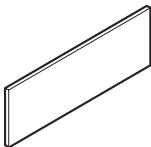

Tackboard for Shared Divider Storage Filler

STB1113	.62 x 11 x 13.25	70	1.21	.23	1	\$190
					2	\$204
					3	\$215
					4	\$232
					5	\$255

For use with **S4813PCL/S4813POL** shared divider storage filler. Covers small area on the back of the storage upper.

Velcro included for attachment.

Also for use with **S4813PCH/S4813POH** shared divider storage filler. Covers small area on the back of the storage upper

Required Specifications

Fabric

TACKBOARDS FOR STACK-ON OPEN SHELVES

MODEL# DIMENSIONS FREIGHT CLASS WT/LBS. CUBIC FT. FABRIC GRD. LIST PRICE

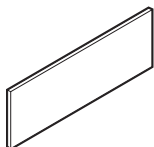

Tackboard for Stack-On Open Shelf

		D x W x H				
STB3020	.62 x 30 x 20	125	5	.81	1	\$297
					2	\$325
					3	\$348
					4	\$381
					5	\$428

For use with **S3013BH** stack-on open shelf. Covers entire back panel. Velcro included for attachment.

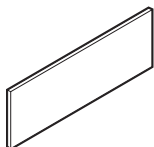

Tackboard for Stack-On Open Shelf

STB3620	.62 x 36 x 20	125	6	.97	1	\$328
					2	\$363
					3	\$391
					4	\$432
					5	\$491

For use with **S3613BH** stack-on open shelf. Covers entire back panel. Velcro included for attachment.

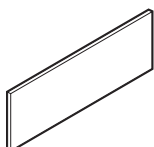

Tackboard for Stack-On Open Shelf

STB4220	.62 x 42 x 20	125	7	1.12	1	\$374
					2	\$417
					3	\$450
					4	\$500
					5	\$571

For use with **S4213BH** stack-on open shelf. Covers entire back panel. Velcro included for attachment.

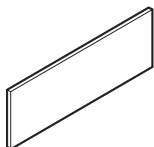

Tackboard for Stack-On Open Shelf

STB4820	.62 x 48 x 20	125	8	1.27	1	\$422
					2	\$464
					3	\$497
					4	\$546
					5	\$617

For use with **S4813BH** stack-on open shelf. Covers entire back panel. Velcro included for attachment.

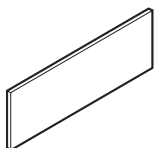

Tackboard for Stack-On Open Shelf

STB1820	.62 x 18 x 20	150	3	.51	1	\$240
					2	\$261
					3	\$278
					4	\$302
					5	\$338

For use with **S3614BH2** stack-on open shelf. Covers entire back panel. Velcro included for attachment.

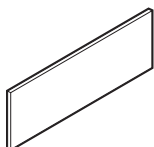

Tackboard for Stack-On Open Shelf

STB2120	.62 x 21 x 20	150	3.50	.59	1	\$253
					2	\$273
					3	\$290
					4	\$316
					5	\$352

For use with **S4214BH2** stack-on open shelf. Covers entire back panel. Velcro included for attachment.

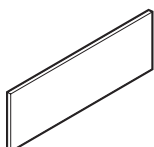

Tackboard for Stack-On Open Shelf

STB2420	.62 x 24 x 20	125	4	.66	1	\$270
					2	\$299
					3	\$321
					4	\$355
					5	\$402

For use with **S4814BH2** stack-on open shelf. Covers entire back panel. Velcro included for attachment.

Required Specifications

Fabric

TACKBOARDS FOR STACK-ON OPEN SHELVES

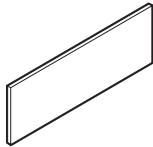

Tackboard for Stack-On Open Shelf

MODEL#	DIMENSIONS D x W x H	FREIGHT CLASS	WT./LBS.	CUBIC FT.	FABRIC GRD.	LIST PRICE
STB3020	.62 x 30 x 20	125	5	.81	1	\$297
					2	\$325
					3	\$348
					4	\$381
					5	\$428

For use with **S6014BH2** stack-on open shelf. Covers entire back panel. Velcro included for attachment.

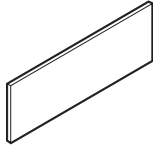

Tackboard for Stack-On Open Shelf

STB3620	.62 x 36 x 20	125	6	.97	1	\$328
					2	\$363
					3	\$391
					4	\$432
					5	\$491

For use with **S7214BH2** stack-on open shelf. Covers entire back panel. Velcro included for attachment.

TACKBOARDS FOR HUTCHES

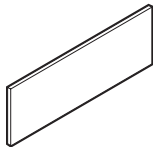

Tackboard for Hutches

STB2812	.62 x 28 x 12	150	2.80	.49	1	\$264
					2	\$293
					3	\$315
					4	\$349
					5	\$395

For use on **S3014EHO/S3015EHT** hutches. Velcro included for attachment.

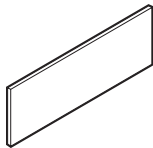

Tackboard for Hutches

STB3412	.62 x 34 x 12	150	3.40	.58	1	\$294
					2	\$328
					3	\$356
					4	\$397
					5	\$457

For use on **S3614EHO/S3615EHT** hutches. Velcro included for attachment.

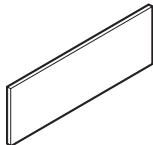

Tackboard for Hutches

STB4012	.62 x 40 x 12	150	4	.68	1	\$321
					2	\$363
					3	\$396
					4	\$446
					5	\$518

For use on **S4214EHO/S4215EHT** hutches. Velcro included for attachment.

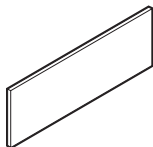

Tackboard for Hutches

STB4612	.62 x 46 x 12	150	4.60	.78	1	\$374
					2	\$417
					3	\$450
					4	\$500
					5	\$571

For use on **S4814EHO/S4815EHT** hutches. Velcro included for attachment.

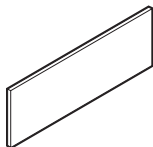

Tackboard for Hutches

STB5812	.62 x 58 x 12	150	5.80	.97	1	\$452
					2	\$507
					3	\$553
					4	\$618
					5	\$713

For use on **S6014EHO/S6015EHT** hutches. Velcro included for attachment.

Required Specifications

Fabric

TACKBOARDS FOR HUTCHES

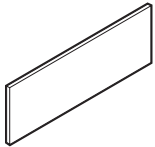

Tackboard for Hutches

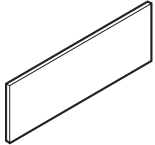

Tackboard for Hutches

MODEL#	DIMENSIONS	FREIGHT CLASS	WT/LBS.	CUBIC FT.	FABRIC GRD.	LIST PRICE
--------	------------	---------------	---------	-----------	-------------	------------

	D x W x H					
STB7012	.62 x 70 x 12	150	7	1.17	1	\$525
					2	\$588
					3	\$637
					4	\$712
					5	\$818

For use on **S7214EHO/S7215EHT** hutches. Velcro included for attachment.

STB8212	.62 x 82 x 12	125	8.20	1.36	1	\$637
					2	\$707
					3	\$763
					4	\$846
					5	\$964

For use on **S8414EHO/S8415EHT** hutches. Velcro included for attachment.

Required Specifications

Fabric

POWER DELIVERY / CABLE MANAGEMENT

D x W x H

At the basic level, table and floor based office equipment is serviced by a wall or floor power supply. As the operation grows, there might be a need to organize excessive cable clutter.

(1) **Cable Snake JBPS** installed in proximity of floor monument to manage vertical cable clutter.

Table clamped, single circuit (2) **Desk Top Power Data Modules** deliver services to desk height, while tapping into wall or floor power supply. Excessive cables can be managed with (3) **Wire Management Clamps BWMS5**.

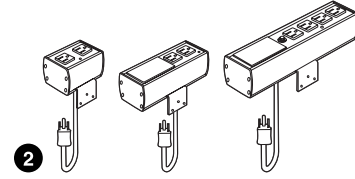

(4) **Below Worksurface Power/Data Troughs** can be installed between back-to-back tables for extended below desk height power/data distribution.

- 8 wire, 4-circuit system. (2 + 2 circuit configuration)

To specify electrical, utilize the following steps:

- For each back-to-back worksurface, specify (1) **SEDBKIT**
 - SEDBKIT is centered below the wire pass thru on the surface
 - Unlike other wiring systems, Sidebar's electrical can have individual simplex outlets on different circuits
- Specify a total of (4) simplex outlets per user - up to four different circuits can be specified for a single user
- Jumpers (SExxFFJ) will bring power from one SEDBKIT to another - subtract 6" from the worksurface length to calculate the necessary length jumper
- Currently, Sidebar can only accommodate basefeeds from a floor or wall
- Basefeeds (SEBFxx) are available in multiple lengths and can be positioned at the end of a run or the middle of a run
- Global recommends the use of a vertical cable manager (such as the JBPS or PCSN01) to manage the basefeed and data cable from floor or wall to the underside of a worksurface

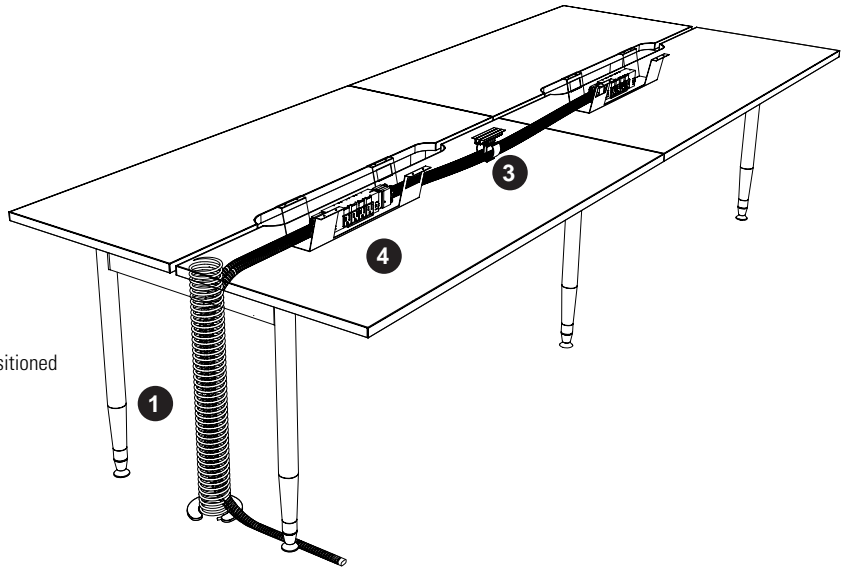

4-2-2 Wiring Schematic

8-Wire Shared Neutral

"2 + 2" - 2 Utility Circuits, 2 Dedicated

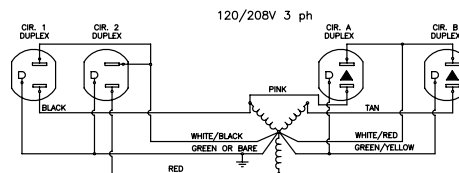
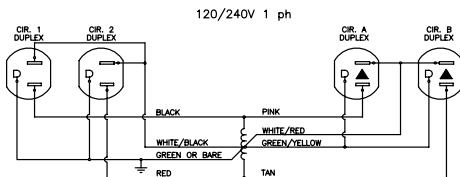

8 Wires

4 lines (12 ga.)
2 Neutrals (10 ga.)
2 Grounds (12 ga.)

4 Circuits

2 Utility circuits
2 Dedicated Circuits

Receptacles

Duplex - Up to 12 duplex receptacles per circuit
(Up to 48 per infeed)

Specifications

System rated for connection to a grounded 120/240 V single phase, 20A, 60Hz or 120/208 V, 3 phase, 20A, 60Hz branch circuit for U.S. and 15A if product is marked with a C-UL Mark. Outlets rated 15A max.

POWER DELIVERY / CABLE MANAGEMENT

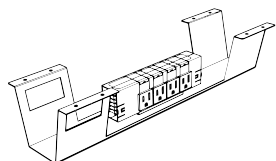

Below Worksurface Double Power/Data Trough

MODEL# DIMENSIONS FREIGHT CLASS WT/LBS. CUBIC FT. LIST PRICE

	D x W x H				
SEDBKIT	7 x 20 x 6	250	3	.80	\$263

Formed steel trough with double sided Power block is secured below worksurface, centered. Four simplex outlets can be specified on each side (sold separately). One trough size can be used on all worksurface sizes. Specify jumpers between tables separately. Base feed entry can be made at either end of trough. Each trough has one opening at 1.37" x 2.68" (one per side) for data/communication terminal plates. Specify Silver (SI) or Black (BK) finish.

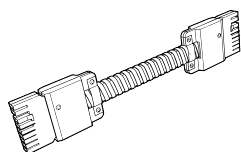

Jumper Cable

SE36FFJ	3 x 36 x 3	70	1.37	.50	\$108
SE39FFJ	3 x 39 x 3	70	1.52	.50	\$112
SE42FFJ	3 x 42 x 3	70	1.60	.50	\$115
SE45FFJ	3 x 45 x 3	70	1.75	.50	\$119
SE48FFJ	3 x 48 x 3	70	1.82	.50	\$122
SE51FFJ	3 x 51 x 3	70	1.98	.50	\$126
SE54FFJ	3 x 54 x 3	150	2.05	.50	\$129
SE57FFJ	3 x 57 x 3	150	2.20	.50	\$132
SE60FFJ	3 x 60 x 3	150	2.28	.50	\$136
SE63FFJ	3 x 63 x 3	150	2.43	.50	\$140
SE66FFJ	3 x 66 x 3	150	2.51	.50	\$144
SE69FFJ	3 x 69 x 3	150	2.66	.50	\$147
SE72FFJ	3 x 72 x 3	150	2.74	.50	\$151
SE75FFJ	3 x 75 x 3	150	2.89	.50	\$154
SE78FFJ	3 x 78 x 3	150	2.96	.50	\$158

Flexible metal conduit is used to distribute electrical power from one trough to another. To calculate the length needed between power troughs, take the measurement of the center of one trough to another and subtract 6".
Example: Two 72" workstations would necessitate a 66" jumper.

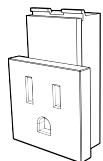

Simplex Receptacle

SE8R1	1 x 1.5 x 2	70	.04	.01	\$14
SE8R2	1 x 1.5 x 2	70	.04	.01	\$14
SE8RA	1 x 1.5 x 2	70	.04	.01	\$14
SE8RB	1 x 1.5 x 2	70	.04	.01	\$14

Snaps into Power block. Up to 13 duplex receptacles per circuit. Black finish for Circuits 1 and 2. Orange finish for Circuits A and B.

- SE8R1 - Circuit #1 (utility circuit)
- SE8R2 - Circuit #2 (utility circuit)
- SE8RA - Circuit A (dedicated circuit)
- SE8RB - Circuit B (dedicated circuit)

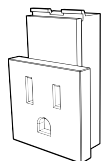

Controlled Circuit Simplex Receptacle

SE8R1CA	1 x 1.5 x 2	70	.04	.01	\$19
SE8R2CA	1 x 1.5 x 2	70	.04	.01	\$19
SE8RACA	1 x 1.5 x 2	70	.04	.01	\$19
SE8RBCA	1 x 1.5 x 2	70	.04	.01	\$19

Snaps into Power block. Up to 13 duplex receptacles per circuit. Black finish for Circuits 1 and 2. Orange finish for Circuits A and B. Meets California Title 24, Federal and LEED Certification.

- SE8R1CA - Circuit #1 (utility circuit)
- SE8R2CA - Circuit #2 (utility circuit)
- SE8RACA - Circuit A (dedicated circuit)
- SE8RBCA - Circuit B (dedicated circuit)

Required Specifications

Finish (SEDBKIT)

POWER DELIVERY / CABLE MANAGEMENT

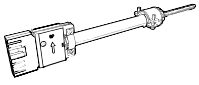

Base Feed

MODEL#	DIMENSIONS D x W x H	FREIGHT CLASS	WT/LBS.	CUBIC FT.	LIST PRICE
SEBF72	5 x 72 x 5	250	2.74	.80	\$140
SEBF120	5 x 120 x 5	150	4.56	.80	\$196
SEBF144	5 x 144 x 5	125	5.47	.80	\$225

Provides single power entry from floor or wall located building power supply. Connects to Power block. Must be hard wired to the building power supply by a licensed electrician.

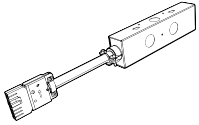

Base Feed - New York Electrical

SEBFNYC	5 x 120 x 5	125	5	.80	\$250
---------	-------------	-----	---	-----	--------------

Provides single power entry from floor or wall located building power supply. Connects to Power block. Must be hard wired to the building power supply by a licensed electrician.

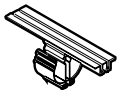

Wire Management - 5" Track

BWMS5	2 x 5 x 3.5	70	1	.10	\$11
-------	-------------	----	---	-----	-------------

Retrofittable track mounts to the underside of worksurface. Includes one wire clamp that can route data and voice wires separately. Black only.

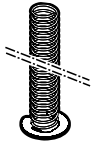

Power Snake

JBPS	4 x 4 x 34	100	2	.25	\$77
------	------------	-----	---	-----	-------------

Attaches to the underside of worksurface with supplied wood screws. Used to organize and channel wires from the power/data management trough down to the floor infeed. Black finish only.



Cable Snake

PCSN01	-- x -- x --	92.5	2.10	.20	\$106
--------	--------------	------	------	-----	--------------

Flexible cable management. Provides access to power/data from floor to underside of worksurface where it attaches. Two pathways within Cable Snake. Length under desk is 31.25". Silver (**SIL**) plastic only.

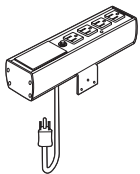

4 Outlet, 1 Telecom Blank Plate

PGDPS41	2.5 x 10.25 x 2.22	70	1.50	.02	\$189
---------	--------------------	----	------	-----	--------------

4 power receptacles and 1 telecom blank plate. Available for mounting behind pull-out shelf or open space credenza. Tungsten (TUN) finish. 12 foot black cord.

POWER DELIVERY / CABLE MANAGEMENT

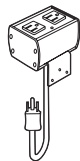

2 Outlet Power block

MODEL#	DIMENSIONS	FREIGHT CLASS	WT/LBS.	CUBIC FT.	LIST PRICE
D x W x H					
PGDPS20	2.5 x 3.58 x 2.22	70	1	.01	\$135

2 power receptacles. Available for side mounted installation. Tungsten (TUN) finish. 12 foot black cord.

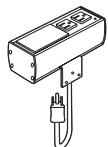

2 Outlet, 1 Telecom Blank Plate

PGDPS21	2.5 x 6.75 x 2.22	70	1.25	.01	\$175
---------	-------------------	----	------	-----	--------------

2 power receptacles and 1 telecom blank plate. Available for side mounted installation. Tungsten (TUN) finish. 12 foot black cord.

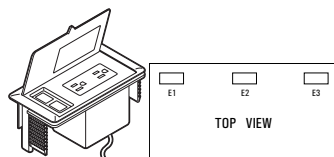

Power/Data Block

PMSPDM	3.5 x 6.5 x 2.75	70	2	.10	\$261
--------	------------------	----	---	-----	--------------

Worksurface power and data module. Two power receptacles and two data receptacles. Specify position and add **\$65.00** for cutout in worksurface. See diagram E1/E2/E3 for specification location. Black (**BLK**) only.

VILLA I SERIES CORDED UNITS

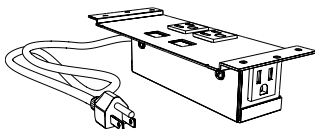

Data Knockouts, No Data Ports

VIL-C-DKO--108	10 x 11 x 7	100	4	.45	\$192
VIL-C-DKO--72	10 x 11 x 7	100	4	.45	\$192

Villa I with 3-prong plug. Includes **two power receptacles** and two knockouts for data. A third convenience receptacle is provided below the worksurface. **V1, V2 or V3 cutout(s) must be specified on training table** (see product notes section for more details and cutout upcharge). **Grommet cover is required and sold separate** (see next page). UL/CUL listed.

- Replace _ with **B** for **Black**
- Replace _ with **S** for **Silver Pearl**

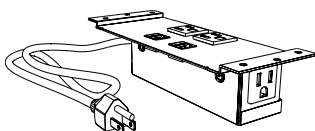

Data Knockouts, Data Ports Included

VIL-C-D--108	10 x 11 x 7	100	4	.45	\$311
VIL-C-D--72	10 x 11 x 7	100	4	.45	\$311

Villa I with 3-prong plug. Includes **two power receptacles** and **two RJ45** Cat 6 data. A third convenience receptacle is provided below the worksurface. **V1, V2 or V3 cutout(s) must be specified on training table** (see product notes section for more details and cutout upcharge). **Grommet cover is required and sold separate** (see next page). UL/CUL listed.

- Replace _ with **B** for **Black**
- Replace _ with **S** for **Silver Pearl**

S SIDEBAR

VILLA GROMMET COVERS

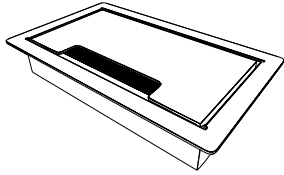

Villa Grommet Cover

MODEL#	DIMENSIONS D x W x H	FREIGHT CLASS	WT/LBS.	CUBIC FT.	LIST PRICE
VIL-GROM-F-__	5 x 7 x 4	70	1	.08	\$96

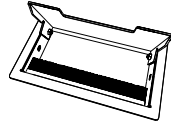

Powder coated flush metal grommet to be used with Villa I **corded** series Power blocks. Cutouts in tables must be specified separately. **V1, V2 or V3 cutout(s) must be specified on training table** (see product notes section for more details and cutout upcharge). **Grommet cover remains open while in use.**

- **Cannot be used with PMSPDM.**
- Replace __ with **B** for **Black**
- Replace __ with **S** for **Silver Pearl**

TOP TELECOM PLATES

For use with SEDBKIT - not compatible with Villa units.



A-__-A-B

Telecom plate with RJ11 Cat 3 Phone and RJ45 Cat 6 Data

\$83



A-__-B-B

(2) RJ45 Cat 6 Connectors

\$109



A-__-B-B-B

(3) RJ45 Cat 6 Connectors

\$159



A-__-B-B-B-B

(4) RJ45 Cat 6 Connectors

\$211



A-__-B-C51-L

RJ45 Cat 6 Data, Mini-Stereo Inline and 15 pin HD VGA Female/Female with 72" patch cord attached.

\$188



A-__-B-B-C51

(2) RJ45 Cat 6 Data and (1) 15 pin HD VGA Female/Female with 72" patch cord attached.

\$196



A-__-A-B-102

RJ11 Cat 3 phone, RJ45 Cat 6 Data and USB with 72" patch cord attached.

\$188



A-__-B

RJ45 Cat 6 Data

\$57









A-__-C51-L

Mini Stereo Inline and 15 pin HD VGA Female/Female with 72" patch cord attached.

\$147

Required Specifications

- Finish
- Power Infeed
- Cutout location

TOP TELECOM PLATES	MODEL	CONFIGURATION	LIST PRICE
	A-__-CRDMINDER	D x W x H Cordminder Plate - 2 5/8" holes and 1 7/8" holes	\$32
	A-__-C45-C51-L	HDMI Female/Female with 36" patch cord attached. Mini Stereo Inline and 15 Pin HD VGA Female/Female with 72" patch cord attached.	\$257
	A-__-C45	HDMI Female/Female with 36" patch cord attached.	\$126
	A-__-A-B-B	(1) RJ11 Cat 3 Phone and (2) RJ45 Cat 6 data.	\$137
	A-__	Blank telecom plate	\$7
	A-__-102	USB with 72" patch cord attached.	\$57
	A-__-C51	15 pin HD VGA Female/Female with 72" patch cord attached.	\$94

- Replace _ with **BL** for **Black**
- Replace _ with **GR** for **Grey**

Required Specifications

Finish
Power Infeed
Cutout location



Intelli Beam™ brings forward a new era of open workspaces, combining the robust capabilities of panel systems with the flexibility and style demanded in today's office and education environments.

Integrate Intelli Beam with FreeFit and Foli height adjustable tables, Bungee, Junction or 2gether tables, or pair with Global metal or laminate storage to optimize your workspace while supporting both collaborative and individual needs. Extension kits offer privacy and height options for sitting and/or standing variations. Extension kits are available in tackable fabrics, laminate, and frosted or clear tempered glass. Laminate end-of-run panels add a finishing touch.

Intelli Beam's modular design make it easy to specify. Simply start the run and "add-on" with two leg choices - post or t-leg. Run power/data from a base feed kit up and into the Intelli Beam system. Punch outs on beam provide easy access for power and a center knockout for data.

Features and Benefits

- Delivers power at 3 heights - 24", 30", 36"
- Extension modules offered in fabric, laminate or glass
- Leg options: infeed with post leg, infeed with t-leg, or t-leg
- Integrates with FreeFit and Foli height adjustable tables, Bungee, Junction or 2gether tables
- Pair with Global metal or laminate storage
- Made from recycled materials and is 100% recyclable



Duplex receptacles snap into raceway.



Optional cable chain manages power from the raceway to any table.



Tackable fabric extension kits and optional privacy glass.

GENERAL INFORMATION

- Freestanding beam delivers power at 3 heights - 24", 30", 36"
- Extensions add fabric, laminate or glass division (available in 6", 12" and 18"H)
- Frameless privacy glass available at 6", 9" and 12"H
- For use with height adjustable or fixed tables
- Global laminate products are in compliance with stringent emission guidelines set out by the Greenguard Environmental Institute under the standards for low emitting products and materials. www.greenguard.org.
- **Level 3 Certified**

BEAM INFORMATION

- All metal components are painted with environmentally friendly epoxy powder
- Raceway interiors are coated with recycled epoxy powder
- The entire Intelli Beam product line and the processes used to manufacture it are designed to save and protect the environment. Intelli Beam is made from recycled materials and is 100% recyclable.
- Modules conform to CGSB and ANSI/BIFMA standards
- Modules have a steel frame and are 2.875" thick
- Leveling glides extend 1.25" long

INTELLI BEAM OPTIONS

- Powered raceway modules are available in the following heights: 24", 30", 36"
- All raceways come in (7) sizes: 36", 42", 48", 54", 60", 66" and 72"
- 66"w modules include (1) 30" and (1) 36" Intelli Beam raceway
- 72"w modules include (2) 36" Intelli Beam raceways

EXTENSION MODULES

- Attaches to the top of the beam
- Offered in 6", 12" and 18" heights
- Can be stacked up to 42" H above a finished floor (A.F.F.)

EXTENSION MODULE OPTIONS

- Tackable fabric
- Glazed - clear or frosted tempered glass
- Laminate

FRAMELESS PRIVACY GLASS

- Integrated into top trim
- Available in clear or frosted tempered glass
- 6", 9" and 12" high

RECONFIGURATION

- Extension modules can be modified on site by replacing fabric modules with Glazed or Laminate at any time after the initial installation
- Fabric can be replaced easily; using pre-cut segments of fabric, a drawstring (C-Jex) is sewn in around the edges. Then a rubber spline is used to 'screen' the fabric in place. Contact Customer Care for part #'s and pricing if required.

VOICE/DATA AND ELECTRICAL POWER

- NOTE: module and electric components are CSA/UL approved. Tools are not required to install electrical in the Evolve Panel System.

Voice and Data can be run at the following level:

- Power beam - 24", 30" or 36" H
- Dealer to provide data components

ADDITIONAL DATA AND ELECTRIC OPTIONS

- Desktop modules are available to install on the worksurface for electric, data and USB (via Productivity Solutions - see page 516)
- Vertical basefeed cover provides entry for the standard or NY infeed

ELECTRIC INFORMATION

- Electric can be run in the power beam module:
 - 8-Wire, 4-Circuit Capability
 - 2 Utility + 2 Dedicated Circuits
 - 10 Gauge (oversized) Neutrals.
- All circuits can support up to 20 amps (15 CSA). Controlled circuit duplexes and USB duplexes available.
- New York and Chicago electrical options available, see page 500

RACEWAY INFORMATION

- Raceway knockouts sizes conform to the ANSI/TIA/EIA Furniture Opening Standard of 1.38" x 2.71" at the base and Beltline.
- Power beam modules 36"-60" wide include raceway covers with three knockouts.
- Power beam modules 66" wide include raceway covers with five knockouts.
- Power beam modules 72" wide include raceway covers with six knockouts.
- Standard data face mount plates can be used without the need of adapter plates (supplied by others).
- Center knockouts in raceway covers are for data only.

Cabling Capacities

(calculations below are based on CAT5 cables)

Power Beam Module

- Without Electric – 65 Cables
- With Electric – 54 Cables

WORKSURFACES

- Foli height adjustable table (24" H beam)
- Bungee, Junction or 2gether tables (30" or 36" H beam)

STORAGE

- Global metal or laminate storage can be paired with Intelli Beam

LAMINATE FINISHES

ACJ	Absolute Acajou	HGT	Hayden Grey
ASN	Asian Night	QTM	Quartered Mahogany
AWC	Avant Cherry	SOG	Storm Grey
AWH	Avant Honey	TFW	Tiger Fruitwood
BLK	Black	TWL	Tiger Walnut
BRC	Brushed Cobalt	WHE	Walnut Heights
CMB	Clear Maple	WHC	White Chocolate
DES	Dark Espresso	WCR	Winter Cherry
DWT	Designer White	WGY	Willow Grey

METAL FINISHES:

BLK	Black
DWT	Designer White
TUN	Tungsten

FABRIC

Anchorage panel fabric only.

STARTER BEAM KITS

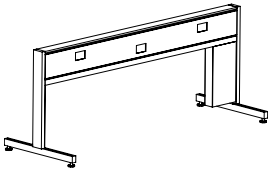

24" H Starter Beam Kits

MODEL#	DIMENSIONS D x W x H	FREIGHT CLASS	WT/LBS.	CUBIC FT.	LIST PRICE
IBBSU2436	2.87 x 36 x 24	85	32.50	2.57	\$976
IBBSU2442	2.87 x 42 x 24	85	34.10	2.65	\$998
IBBSU2448	2.87 x 48 x 24	85	50	4	\$1038
IBBSU2454	2.87 x 54 x 24	85	37.20	2.81	\$1067
IBBSU2460	2.87 x 60 x 24	85	38.80	2.89	\$1082
IBBSU2466	2.87 x 66 x 24	70	48	3	\$1566
IBBSU2472	2.87 x 72 x 24	70	49	3.09	\$1599

24"H starter beam kit with (2) T-legs - one T-leg is slotted for the vertical basefeed cover. Includes Intelli Beam raceway, vertical base feed cover, power distribution housing, 17" electrical jumper cable and (2) end of run trims. Each raceway includes (2) knockouts for duplexes and (1) center knockout for data. Can be used as a freestanding two pack or used as the start of a longer run. For add-on beam kits, see page 484.

- 66"W Intelli Beam starter kits include (1) 30"W and (1) 36"W raceway, (1) inline connector and (1) extra 17" electrical jumper cable.
- 72"W Intelli Beam kits include (2) 36"W raceways, (1) inline connector and (1) extra 17" electrical jumper cable.

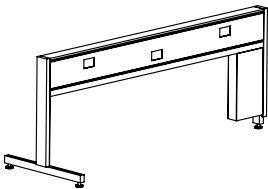

24" H Starter Beam Kits

IBBSP2436	2.87 x 36 x 24	85	32.50	2.57	\$942
IBBSP2442	2.87 x 42 x 24	85	34.10	2.65	\$964
IBBSP2448	2.87 x 48 x 24	85	35.60	2.73	\$1004
IBBSP2454	2.87 x 54 x 24	85	37.20	2.81	\$1034
IBBSP2460	2.87 x 60 x 24	85	38.80	2.89	\$1049
IBBSP2466	2.87 x 66 x 24	70	48	3	\$1533
IBBSP2472	2.87 x 72 x 24	70	49	3.09	\$1565

24"H starter beam kit with (1) T-leg and (1) post leg with slotting for vertical basefeed cover. Includes Intelli Beam raceway, vertical base feed cover, power distribution housing, 17" electrical jumper cable and (2) end of run trims. Each raceway includes (2) knockouts for duplexes and (1) center knockout for data. Can be used as a freestanding two pack or used as the start of a longer run. For add-on beam kits, see page 484.

- 66"W Intelli Beam starter kits include (1) 30"W and (1) 36"W raceway, (1) inline connector and (1) extra 17" electrical jumper cable.
- 72"W Intelli Beam kits include (2) 36"W raceways, (1) inline connector and (1) extra 17" electrical jumper cable.
- Vertical basefeed cover must be installed on post leg.

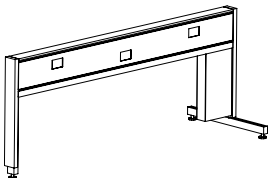

24" H Starter Beam Kits

IBBST2436	2.87 x 36 x 24	85	32.50	2.57	\$976
IBBST2442	2.87 x 42 x 24	85	34.10	2.65	\$998
IBBST2448	2.87 x 48 x 24	85	50	4	\$1038
IBBST2454	2.87 x 54 x 24	85	37.20	2.81	\$1067
IBBST2460	2.87 x 60 x 24	85	38.80	2.89	\$1082
IBBST2466	2.87 x 66 x 24	70	48	3	\$1566
IBBST2472	2.87 x 72 x 24	70	49	3.09	\$1599

24"H starter beam kit with (1) T-leg with slotting for vertical basefeed cover and (1) post leg. Includes Intelli Beam raceway, vertical base feed cover, power distribution housing, 17" electrical jumper cable and (2) end of run trims. Each raceway includes (2) knockouts for duplexes and (1) center knockout for data. Can be used as a freestanding two pack or used as the start of a longer run. For add-on beam kits, see page 484.

- 66"W Intelli Beam starter kits include (1) 30"W and (1) 36"W raceway, (1) inline connector and (1) extra 17" electrical jumper cable.
- 72"W Intelli Beam kits include (2) 36"W raceways, (1) inline connector and (1) extra 17" electrical jumper cable.
- Vertical basefeed cover must be installed on T-leg.

Required Specifications

Paint finish

STARTER BEAM KITS

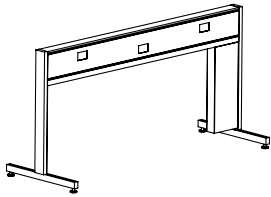

30" H Starter Beam Kits

MODEL# DIMENSIONS FREIGHT CLASS WT./LBS. CUBIC FT. LIST PRICE

D x W x H

IBBSU3036	2.87 x 36 x 30	92.5	33.90	3.04	\$1041
IBBSU3042	2.87 x 42 x 30	92.5	35.50	3.12	\$1064
IBBSU3048	2.87 x 48 x 30	92.5	37	3.20	\$1105
IBBSU3054	2.87 x 54 x 30	92.5	38.60	3.28	\$1133
IBBSU3060	2.87 x 60 x 30	85	50	4	\$1149
IBBSU3066	2.87 x 66 x 30	60	49.40	.38	\$1633
IBBSU3072	2.87 x 72 x 30	65	50.40	2.18	\$1666

30"H starter beam kit with (2) T-legs - one T-leg is slotted for the vertical basefeed cover. Includes Intelli Beam raceway, vertical base feed cover, power distribution housing, 17" electrical jumper cable and (2) end of run trims. Each raceway includes (2) knockouts for duplexes and (1) center knockout for data. Can be used as a freestanding two pack or used as the start of a longer run. For add-on beam kits, see page 484.

- 66"W Intelli Beam starter kits include (1) 30"W and (1) 36"W raceway, (1) inline connector and (1) extra 17" electrical jumper cable.
- 72"W Intelli Beam kits include (2) 36"W raceways, (1) inline connector and (1) extra 17" electrical jumper cable.

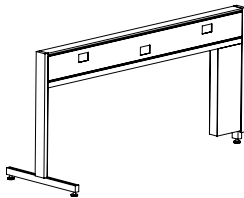

30" H Starter Beam Kits

IBBSP3036	2.87 x 36 x 30	92.5	33.90	3.04	\$1007
IBBSP3042	2.87 x 42 x 30	92.5	35.50	3.12	\$1029
IBBSP3048	2.87 x 48 x 30	92.5	37	3.20	\$1070
IBBSP3054	2.87 x 54 x 30	92.5	38.60	3.28	\$1100
IBBSP3060	2.87 x 60 x 30	92.5	40.20	3.36	\$1115
IBBSP3066	2.87 x 66 x 30	85	49.40	3.47	\$1599
IBBSP3072	2.87 x 72 x 30	85	50.40	3.56	\$1631

30"H starter beam kit with (1) T-leg and (1) post leg with slotting for vertical basefeed cover. Includes Intelli Beam raceway, vertical base feed cover, power distribution housing, 17" electrical jumper cable and (2) end of run trims. Each raceway includes (2) knockouts for duplexes and (1) center knockout for data. Can be used as a freestanding two pack or used as the start of a longer run. For add-on beam kits, see page 484.

- 66"W Intelli Beam starter kits include (1) 30"W and (1) 36"W raceway, (1) inline connector and (1) extra 17" electrical jumper cable.
- 72"W Intelli Beam kits include (2) 36"W raceways, (1) inline connector and (1) extra 17" electrical jumper cable.
- Vertical basefeed cover must be installed on post leg.

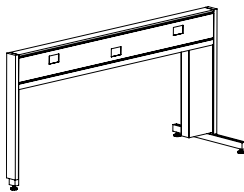

30" H Starter Beam Kits

IBBST3036	2.87 x 36 x 30	92.5	33.90	3.04	\$1041
IBBST3042	2.87 x 42 x 30	92.5	35.50	3.12	\$1064
IBBST3048	2.87 x 48 x 30	92.5	37	3.20	\$1105
IBBST3054	2.87 x 54 x 30	92.5	38.60	3.28	\$1133
IBBST3060	2.87 x 60 x 30	85	50	4	\$1149
IBBST3066	2.87 x 66 x 30	60	49.40	.38	\$1633
IBBST3072	2.87 x 72 x 30	65	50.40	2.18	\$1666

30"H starter beam kit with (1) T-leg with slotting for vertical basefeed cover and (1) post leg. Includes Intelli Beam raceway, vertical base feed cover, power distribution housing, 17" electrical jumper cable and (2) end of run trims. Each raceway includes (2) knockouts for duplexes and (1) center knockout for data. Can be used as a freestanding two pack or used as the start of a longer run. For add-on beam kits, see page 484.

- 66"W Intelli Beam starter kits include (1) 30"W and (1) 36"W raceway, (1) inline connector and (1) extra 17" electrical jumper cable.
- 72"W Intelli Beam kits include (2) 36"W raceways, (1) inline connector and (1) extra 17" electrical jumper cable.
- Vertical basefeed cover must be installed on T-leg.

Required Specifications

Paint finish

STARTER BEAM KITS

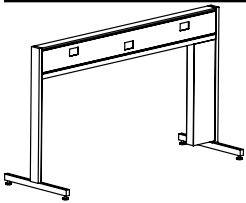

36" H Starter Beam Kits

MODEL#	DIMENSIONS D x W x H	FREIGHT CLASS	WT/LBS.	CUBIC FT.	LIST PRICE
IBBSU3636	2.87 x 36 x 36	92.5	36.30	3.55	\$1080
IBBSU3642	2.87 x 42 x 36	92.5	37.90	3.63	\$1103
IBBSU3648	2.87 x 48 x 36	92.5	39.40	3.71	\$1136
IBBSU3654	2.87 x 54 x 36	92.5	41	3.79	\$1164
IBBSU3660	2.87 x 60 x 36	60	42.60	.56	\$1180
IBBSU3666	2.87 x 66 x 36	60	51.80	.45	\$1664
IBBSU3672	2.87 x 72 x 36	70	52.80	2.62	\$1697

36"H starter beam kit with (2) T-legs-one T-leg is slotted for the vertical basefeed cover. Includes Intelli Beam raceway, vertical base feed cover, power distribution housing, 17" electrical jumper cable and (2) end of run trims. Each raceway includes (2) knockouts for duplexes and (1) center knockout for data. Can be used as a freestanding two pack or used as the start of a longer run. For add-on beam kits, see page 484.

- 66"W Intelli Beam starter kits include (1) 30"W and (1) 36"W raceway, (1) inline connector and (1) extra 17" electrical jumper cable.
- 72"W Intelli Beam kits include (2) 36"W raceways, (1) inline connector and (1) extra 17" electrical jumper cable.

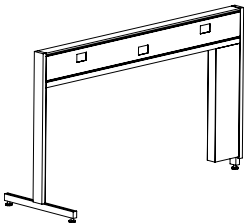

36" H Starter Beam Kits

IBBSP3636	2.87 x 36 x 36	92.5	36.30	3.55	\$1045
IBBSP3642	2.87 x 42 x 36	92.5	37.90	3.63	\$1069
IBBSP3648	2.87 x 48 x 36	92.5	39.40	3.71	\$1101
IBBSP3654	2.87 x 54 x 36	92.5	41	3.79	\$1130
IBBSP3660	2.87 x 60 x 36	92.5	42.60	3.87	\$1146
IBBSP3666	2.87 x 66 x 36	85	51.80	3.98	\$1630
IBBSP3672	2.87 x 72 x 36	85	52.80	4.07	\$1662

36"H starter beam kit with (1) T-leg and (1) post leg with slotting for vertical basefeed cover. Includes Intelli Beam raceway, vertical base feed cover, power distribution housing, 17" electrical jumper cable and (2) end of run trims. Each raceway includes (2) knockouts for duplexes and (1) center knockout for data. Can be used as a freestanding two pack or used as the start of a longer run. For add-on beam kits, see page 484.

- 66"W Intelli Beam starter kits include (1) 30"W and (1) 36"W raceway, (1) inline connector and (1) extra 17" electrical jumper cable.
- 72"W Intelli Beam kits include (2) 36"W raceways, (1) inline connector and (1) extra 17" electrical jumper cable.
- Vertical basefeed cover must be installed on post leg.

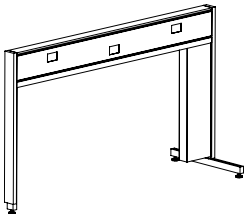

36" H Starter Beam Kits

IBBST3636	2.87 x 36 x 36	92.5	36.30	3.55	\$1080
IBBST3642	2.87 x 42 x 36	92.5	37.90	3.63	\$1103
IBBST3648	2.87 x 48 x 36	92.5	39.40	3.71	\$1136
IBBST3654	2.87 x 54 x 36	92.5	41	3.79	\$1164
IBBST3660	2.87 x 60 x 36	60	42.60	.56	\$1180
IBBST3666	2.87 x 66 x 36	60	51.80	.45	\$1664
IBBST3672	2.87 x 72 x 36	70	52.80	2.62	\$1697

36"H starter beam kit with (1) T-leg with slotting for vertical basefeed cover and (1) post leg. Includes Intelli Beam raceway, vertical base feed cover, power distribution housing, 17" electrical jumper cable and (2) end of run trims. Each raceway includes (2) knockouts for duplexes and (1) center knockout for data. Can be used as a freestanding two pack or used as the start of a longer run. For add-on beam kits, see page 484.

- 66"W Intelli Beam starter kits include (1) 30"W and (1) 36"W raceway, (1) inline connector and (1) extra 17" electrical jumper cable.
- 72"W Intelli Beam kits include (2) 36"W raceways, (1) inline connector and (1) extra 17" electrical jumper cable.
- Vertical basefeed cover must be installed on T-leg.

Required Specifications

Paint finish

ADD-ON BEAM KITS

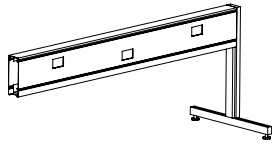

24" H Add-On Beam Kits - T Leg

MODEL#	DIMENSIONS	FREIGHT CLASS	WT/LBS.	CUBIC FT.	LIST PRICE
--------	------------	---------------	---------	-----------	------------

D x W x H

IBBAT2436	2.87 x 36 x 24	65	21.40	.78	\$655
IBBAT2442	2.87 x 42 x 24	65	23	.86	\$675
IBBAT2448	2.87 x 48 x 24	65	24.50	.94	\$715
IBBAT2454	2.87 x 54 x 24	65	26.10	1.02	\$744
IBBAT2460	2.87 x 60 x 24	65	27.70	1.10	\$757
IBBAT2466	2.87 x 66 x 24	60	36.90	1.21	\$1229
IBBAT2472	2.87 x 72 x 24	65	37.90	1.30	\$1261

24"H add-on beam kit with T-leg includes Intelli Beam raceway, power distribution housing and 17" electrical jumper cable. Each raceway includes (2) knockouts for duplexes and (1) center knockout for data. Must be used in conjunction with starter beam kits, beginning on page 486.

- 66"W Intelli Beam kits include (1) 30"W and (1) 36"W raceway, (1) inline connector and (1) extra 17" electrical jumper cable.
- 72"W Intelli Beam kits include (2) 36"W raceways, (1) inline connector and (1) extra 17" electrical jumper cable.

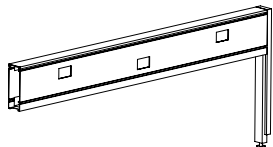

24" H Add-on Beam Kits - Post Leg

IBBAP2436	2.87 x 36 x 24	60	15.50	.48	\$621
IBBAP2442	2.87 x 42 x 24	60	17.10	.56	\$641
IBBAP2448	2.87 x 48 x 24	65	18.60	.64	\$680
IBBAP2454	2.87 x 54 x 24	65	20.20	.72	\$709
IBBAP2460	2.87 x 60 x 24	65	21.80	.80	\$721
IBBAP2466	2.87 x 66 x 24	60	31	.91	\$1194
IBBAP2472	2.87 x 72 x 24	60	32	1	\$1226

24"H add-on beam kit with (1) post leg includes Intelli Beam raceway, vertical base feed cover, power distribution housing, 17" electrical jumper cable and (2) end of run trims. Each raceway includes (2) knockouts for duplexes and (1) center knockout for data. Must be used in conjunction with starter beam kits, beginning on page 486.

- 66"W Intelli Beam kits include (1) 30"W and (1) 36"W raceway, (1) inline connector and (1) extra 17" electrical jumper cable.
- 72"W Intelli Beam kits include (2) 36"W raceways, (1) inline connector and (1) extra 17" electrical jumper cable.

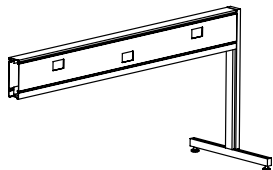

30" H Add-On Beam Kits - T Leg

IBBAT3036	2.87 x 36 x 30	65	22.70	.86	\$660
IBBAT3042	2.87 x 42 x 30	65	24.30	.94	\$680
IBBAT3048	2.87 x 48 x 30	65	25.80	1.02	\$720
IBBAT3054	2.87 x 54 x 30	65	27.40	1.10	\$749
IBBAT3060	2.87 x 60 x 30	65	29	1.18	\$762
IBBAT3066	2.87 x 66 x 30	65	38.20	1.29	\$1234
IBBAT3072	2.87 x 72 x 30	65	39.20	1.38	\$1266

30"H add-on beam kit with T-leg includes Intelli Beam raceway, power distribution housing and 17" electrical jumper cable. Each raceway includes (2) knockouts for duplexes and (1) center knockout for data. Must be used in conjunction with starter beam kits, beginning on page 486.

- 66"W Intelli Beam kits include (1) 30"W and (1) 36"W raceway, (1) inline connector and (1) extra 17" electrical jumper cable.
- 72"W Intelli Beam kits include (2) 36"W raceways, (1) inline connector and (1) extra 17" electrical jumper cable.

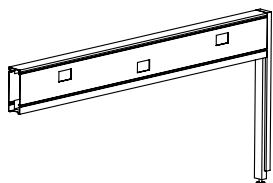

30" H Add-on Beam Kits - Post Leg

IBBAP3036	2.87 x 36 x 30	60	15.50	.48	\$627
IBBAP3042	2.87 x 42 x 30	60	17.10	.56	\$647
IBBAP3048	2.87 x 48 x 30	65	18.60	.64	\$688
IBBAP3054	2.87 x 54 x 30	65	20.20	.72	\$715
IBBAP3060	2.87 x 60 x 30	65	21.80	.80	\$729
IBBAP3066	2.87 x 66 x 30	60	31	.91	\$1200
IBBAP3072	2.87 x 72 x 30	60	32	1	\$1233

30"H add-on beam kit with (1) post leg includes Intelli Beam raceway, vertical base feed cover, power distribution housing, 17" electrical jumper cable and (2) end of run trims. Each raceway includes (2) knockouts for duplexes and (1) center knockout for data. Must be used in conjunction with starter beam kits, beginning on page 486.

- 66"W Intelli Beam kits include (1) 30"W and (1) 36"W raceway, (1) inline connector and (1) extra 17" electrical jumper cable.
- 72"W Intelli Beam kits include (2) 36"W raceways, (1) inline connector and (1) extra 17" electrical jumper cable.

Required Specifications

Paint finish

ADD-ON BEAM KITS

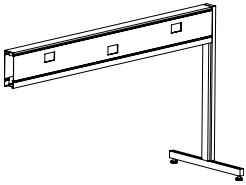

36" H Add-On Beam Kits - T Leg

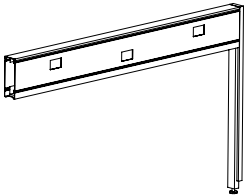

36" H Add-on Beam Kits - Post Leg

MODEL#	DIMENSIONS	FREIGHT CLASS	WT/LBS.	CUBIC FT.	LIST PRICE
--------	------------	---------------	---------	-----------	------------

	D x W x H				
IBBAT3636	2.87 x 36 x 36	65	24	.93	\$665
IBBAT3642	2.87 x 42 x 36	65	25.60	1.01	\$685
IBBAT3648	2.87 x 48 x 36	65	27.10	1.09	\$726
IBBAT3654	2.87 x 54 x 36	65	28.70	1.17	\$754
IBBAT3660	2.87 x 60 x 36	65	30.30	1.25	\$767
IBBAT3666	2.87 x 66 x 36	65	39.50	1.36	\$1240
IBBAT3672	2.87 x 72 x 36	65	40.50	1.45	\$1272

36"H add-on beam kit with T-leg includes Intelli Beam raceway, power distribution housing and 17" electrical jumper cable. Each raceway includes (2) knockouts for duplexes and (1) center knockout for data. Must be used in conjunction with starter beam kits, beginning on page 486.

- 66"W Intelli Beam kits include (1) 30"W and (1) 36"W raceway, (1) inline connector and (1) extra 17" electrical jumper cable.
- 72"W Intelli Beam kits include (2) 36"W raceways, (1) inline connector and (1) extra 17" electrical jumper cable.

IBBAP3636	2.87 x 36 x 36	60	15.50	.48	\$665
IBBAP3642	2.87 x 42 x 36	60	17.10	.56	\$685
IBBAP3648	2.87 x 48 x 36	65	18.60	.64	\$726
IBBAP3654	2.87 x 54 x 36	65	20.20	.72	\$754
IBBAP3660	2.87 x 60 x 36	65	21.80	.80	\$767
IBBAP3666	2.87 x 66 x 36	60	31	.91	\$1240
IBBAP3672	2.87 x 72 x 36	60	32	1	\$1272

36"H add-on beam kit with (1) post leg includes Intelli Beam raceway, vertical base feed cover, power distribution housing, 17" electrical jumper cable and (2) end of run trims. Each raceway includes (2) knockouts for duplexes and (1) center knockout for data. Must be used in conjunction with starter beam kits, beginning on page 486.

- 66"W Intelli Beam kits include (1) 30"W and (1) 36"W raceway, (1) inline connector and (1) extra 17" electrical jumper cable.
- 72"W Intelli Beam kits include (2) 36"W raceways, (1) inline connector and (1) extra 17" electrical jumper cable.

Required Specifications

Paint finish

STARTER EXTENSION KITS

6"



12"



18"

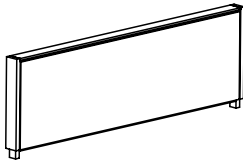

Starter Extension Kit - Fabric

MODEL# DIMENSIONS FREIGHT CLASS WT/LBS. CUBIC FT. LIST PRICE

D x W x H

MODEL#	DIMENSIONS	FREIGHT CLASS	WT/LBS.	CUBIC FT.	LIST PRICE
IBSFE0636	2.87 x 36 x 6	92.5	10.29	1.01	\$354
IBSFE0642	2.87 x 42 x 6	92.5	11.72	1.09	\$381
IBSFE0648	2.87 x 48 x 6	92.5	13.15	1.16	\$400
IBSFE0654	2.87 x 54 x 6	92.5	14.59	1.23	\$420
IBSFE0660	2.87 x 60 x 6	85	16.02	1.31	\$427
IBSFE0666	2.87 x 66 x 6	92.5	18.20	1.60	\$592
IBSFE0672	2.87 x 72 x 6	92.5	19.64	1.67	\$615
IBSFE1236	2.87 x 36 x 12	92.5	14.42	1.42	\$354
IBSFE1242	2.87 x 42 x 12	92.5	15.42	1.42	\$381
IBSFE1248	2.87 x 48 x 12	92.5	16.42	1.61	\$400
IBSFE1254	2.87 x 54 x 12	150	11.42	2.19	\$420
IBSFE1260	2.87 x 60 x 12	92.5	19.42	1.74	\$427
IBSFE1266	2.87 x 66 x 12	70	25.42	1.50	\$592
IBSFE1272	2.87 x 72 x 12	70	26.42	1.54	\$615
IBSFE1836	2.87 x 36 x 18	70	44.50	2.02	\$449
IBSFE1842	2.87 x 42 x 18	70	46.50	2.21	\$476
IBSFE1848	2.87 x 48 x 18	70	48	2.35	\$504
IBSFE1854	2.87 x 54 x 18	70	50	2.43	\$533
IBSFE1860	2.87 x 60 x 18	70	52.50	2.53	\$564
IBSFE1866	2.87 x 66 x 18	70	61	3.41	\$740
IBSFE1872	2.87 x 72 x 18	70	62	3.62	\$777

Fabric starter extension kit attaches on top of a starter beam kit of the same width. Includes fabric extension panel, (2) extension connectors and (2) extension trims. Must be used in conjunction with starter beam kits, beginning on page 486.

- 66"W fabric starter extension kits include (1) 30"W extension panel, (1) 36"W extension panel, and (1) extra extension connector.
- 72"W fabric starter extension kits include (2) 36"W extension panels and (1) extra extension connector.
- Full end of run trim can be specified separate to equal the total height (up to 42"H) of the beam
- **For stability, panels may be stacked no higher than 42" above the floor.**

Required Specifications

Paint finish
Fabric

STARTER EXTENSION KITS

6"



12"

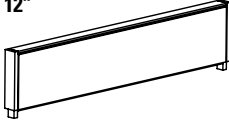

18"

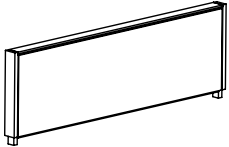

Starter Extension Kit - Laminate

MODEL#	DIMENSIONS D x W x H	FREIGHT CLASS	WT/LBS.	CUBIC FT.	LIST PRICE
IBSLE0636	2.87 x 36 x 6	92.5	10.29	1.01	\$539
IBSLE0642	2.87 x 42 x 6	92.5	11.72	1.09	\$593
IBSLE0648	2.87 x 48 x 6	85	13.15	1.06	\$644
IBSLE0654	2.87 x 54 x 6	92.5	14.59	1.23	\$725
IBSLE0660	2.87 x 60 x 6	85	16.02	1.31	\$739
IBSLE0666	2.87 x 66 x 6	92.5	18.20	1.60	\$935
IBSLE0672	2.87 x 72 x 6	92.5	19.64	1.67	\$986
IBSLE1236	2.87 x 36 x 12	70	28.42	1.42	\$539
IBSLE1242	2.87 x 42 x 12	70	32.42	1.47	\$593
IBSLE1248	2.87 x 48 x 12	65	40.42	1.53	\$644
IBSLE1254	2.87 x 54 x 12	65	48.42	1.67	\$725
IBSLE1260	2.87 x 60 x 12	60	54.42	1.74	\$739
IBSLE1266	2.87 x 66 x 12	70	50.42	2.36	\$935
IBSLE1272	2.87 x 72 x 12	70	54.42	2.54	\$986
IBSLE1836	2.87 x 36 x 18	70	45.40	2.14	\$772
IBSLE1842	2.87 x 42 x 18	70	46.70	2.14	\$849
IBSLE1848	2.87 x 48 x 18	70	47.12	2.53	\$938
IBSLE1854	2.87 x 54 x 18	70	48.75	2.57	\$1014
IBSLE1860	2.87 x 60 x 18	70	51.25	2.93	\$1079
IBSLE1866	2.87 x 66 x 18	70	60.90	3.62	\$1342
IBSLE1872	2.87 x 72 x 18	70	63.80	3.86	\$1424

Laminate starter extension kit attaches on top of a starter beam kit of the same width. Includes laminate extension panel, (2) extension connectors and (2) extension trims. Must be used in conjunction with starter beam kits, beginning on page 486.

- 66"W laminate starter extension kits include (1) 30"W extension panel, (1) 36"W extension panel, and (1) extra extension connector.
- 72"W laminate starter extension kits include (2) 36"W extension panels and (1) extra extension connector.
- Full end of run trim can be specified separate to equal the total height (up to 42"H) of the beam
- **For stability, panels may be stacked no higher than 42" above the floor.**

Required Specifications

Paint finish
Laminate finish

STARTER EXTENSION KITS

6"



12"

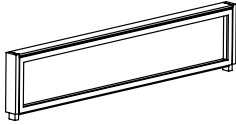

18"

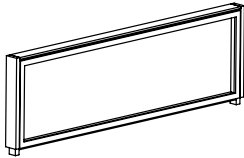

Starter Extension Kit - Glazed

MODEL#	DIMENSIONS D x W x H	FREIGHT CLASS	WT/LBS.	CUBIC FT.	LIST PRICE	FRST ADD
IBSGE0636	2.87 x 36 x 6	85	11.69	.95	\$596	\$168
IBSGE0642	2.87 x 42 x 6	85	12.69	1.01	\$696	\$204
IBSGE0648	2.87 x 48 x 6	92.5	12.69	1.08	\$763	\$229
IBSGE0654	2.87 x 54 x 6	85	13.69	1.14	\$821	\$250
IBSGE0660	2.87 x 60 x 6	85	14.69	1.21	\$873	\$268
IBSGE0666	2.87 x 66 x 6	85	21.44	1.49	\$1077	\$328
IBSGE0672	2.87 x 72 x 6	85	22.40	1.55	\$1100	\$334
IBSGE1236	2.87 x 36 x 12	85	14.42	1.11	\$596	\$168
IBSGE1242	2.87 x 42 x 12	85	15.42	1.22	\$696	\$204
IBSGE1248	2.87 x 48 x 12	92.5	16.42	1.42	\$763	\$229
IBSGE1254	2.87 x 54 x 12	92.5	22.78	2.19	\$821	\$250
IBSGE1260	2.87 x 60 x 12	85	19.42	1.57	\$873	\$260
IBSGE1266	2.87 x 66 x 12	85	25.42	1.80	\$1077	\$328
IBSGE1272	2.87 x 72 x 12	85	26.19	1.86	\$1100	\$334
IBSGE1836	2.87 x 36 x 18	65	50.16	1.74	\$782	\$222
IBSGE1842	2.87 x 42 x 18	65	52.83	1.90	\$865	\$253
IBSGE1848	2.87 x 48 x 18	65	55.54	2.08	\$948	\$283
IBSGE1854	2.87 x 54 x 18	65	58.10	2.26	\$1014	\$307
IBSGE1860	2.87 x 60 x 18	65	60.80	2.46	\$1075	\$329
IBSGE1866	2.87 x 66 x 18	65	70.66	2.84	\$1393	\$508
IBSGE1872	2.87 x 72 x 18	65	73.32	3.06	\$1445	\$443

Glazed starter extension kit attaches on top of a starter beam kit of the same width. Includes glass extension panel, (2) extension connectors and (2) extension trims. Must be used in conjunction with starter beam kits, beginning on page 486. Standard in Clear (CLR) glass. Frosted (FRST) glass is available at an upcharge.

- 66"W glass starter extension kits include (1) 30"W extension panel, (1) 36"W extension panel, and (1) extra extension connector.
- 72"W glass starter extension kits include (2) 36"W extension panels and (1) extra extension connector.
- Full end of run trim can be specified separate to equal the total height (up to 42"H) of the beam
- **For stability, panels may be stacked no higher than 42" above the floor.**

Required Specifications
Paint finish

Optional Specifications
Frosted glass

I INTELLI BEAM™

ADD-ON EXTENSION KITS

6"



12"



18"

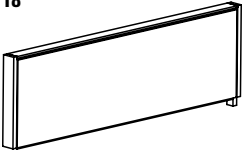

Add-On Extension Kit - Fabric

MODEL#	DIMENSIONS D x W x H	FREIGHT CLASS	WT/LBS.	CUBIC FT.	LIST PRICE
IBAFE0636	2.87 x 36 x 6	85	9.35	.66	\$262
IBAFE0642	2.87 x 42 x 6	85	10.78	.74	\$289
IBAFE0648	2.87 x 48 x 6	70	12.21	.81	\$308
IBAFE0654	2.87 x 54 x 6	70	13.65	.88	\$328
IBAFE0660	2.87 x 60 x 6	70	15.08	.96	\$335
IBAFE0666	2.87 x 66 x 6	85	17.26	1.25	\$500
IBAFE0672	2.87 x 72 x 6	85	18.70	1.32	\$524
IBAFE1236	2.87 x 36 x 12	92.5	12	1.12	\$262
IBAFE1242	2.87 x 42 x 12	92.5	13	1.12	\$289
IBAFE1248	2.87 x 48 x 12	92.5	16	1.50	\$308
IBAFE1254	2.87 x 54 x 12	150	9	1.89	\$328
IBAFE1260	2.87 x 60 x 12	92.5	17	1.44	\$335
IBAFE1266	2.87 x 66 x 12	70	23	1.50	\$500
IBAFE1272	2.87 x 72 x 12	92.5	14	1.24	\$524
IBAFE1836	2.87 x 36 x 18	92.5	17.60	1.60	\$329
IBAFE1842	2.87 x 42 x 18	92.5	19.50	1.79	\$356
IBAFE1848	2.87 x 48 x 18	92.5	21	1.93	\$385
IBAFE1854	2.87 x 54 x 18	92.5	23	2.01	\$412
IBAFE1860	2.87 x 60 x 18	92.5	25.50	2.14	\$443
IBAFE1866	2.87 x 66 x 18	92.5	34	2.99	\$621
IBAFE1872	2.87 x 72 x 18	100	35	3.62	\$658

Fabric add-on extension kit attaches on top of an add-on beam kit of the same width. Includes fabric extension panel and (1) extension connector. Must be used in conjunction with add-on beam kits - see page 484.

- 66"W fabric add-on extension kits include (1) 30"W extension panel, (1) 36"W extension panel, and (1) extra extension connector.
- 72"W fabric add-on extension kits include (2) 36"W extension panels and (1) extra extension connector.
- **For stability, panels may be stacked no higher than 42" above the floor.**

Required Specifications

Paint finish
Fabric

ADD-ON EXTENSION KITS

6"



12"

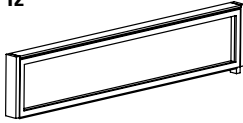

18"

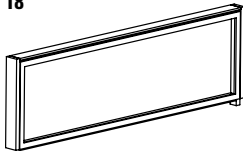

Add-On Extension Kit - Glass

MODEL#	DIMENSIONS D x W x H	FREIGHT CLASS	WT/LBS.	CUBIC FT.	LIST PRICE	FRST ADD
IBAGE0636	2.87 x 36 x 6	70	10.75	.60	\$504	\$168
IBAGE0642	2.87 x 42 x 6	70	11.75	.66	\$605	\$204
IBAGE0648	2.87 x 48 x 6	70	11.75	.73	\$672	\$229
IBAGE0654	2.87 x 54 x 6	70	12.75	.79	\$730	\$250
IBAGE0660	2.87 x 60 x 6	70	13.75	.86	\$781	\$268
IBAGE0666	2.87 x 66 x 6	70	20.50	1.14	\$986	\$328
IBAGE0672	2.87 x 72 x 6	70	21.50	1.20	\$1008	\$334
IBAGE1236	2.87 x 36 x 12	85	12	.81	\$504	\$168
IBAGE1242	2.87 x 42 x 12	85	13	.92	\$605	\$204
IBAGE1248	2.87 x 48 x 12	85	14	1.12	\$672	\$229
IBAGE1254	2.87 x 54 x 12	92.5	20.36	1.89	\$730	\$250
IBAGE1260	2.87 x 60 x 12	85	17	1.27	\$781	\$268
IBAGE1266	2.87 x 66 x 12	70	23	1.50	\$986	\$328
IBAGE1272	2.87 x 72 x 12	85	24	1.62	\$1008	\$334
IBAGE1836	2.87 x 36 x 18	70	23.16	1.32	\$663	\$222
IBAGE1842	2.87 x 42 x 18	70	25.83	1.48	\$745	\$253
IBAGE1848	2.87 x 48 x 18	70	28.54	1.66	\$829	\$283
IBAGE1854	2.87 x 54 x 18	70	31.10	1.84	\$895	\$307
IBAGE1860	2.87 x 60 x 18	70	33.80	2.04	\$955	\$329
IBAGE1866	2.87 x 66 x 18	70	43.66	2.42	\$1273	\$508
IBAGE1872	2.87 x 72 x 18	70	46.32	2.64	\$1324	\$443

Glass add-on extension kit attaches on top of an add-on beam kit of the same width. Includes glass extension panel and (1) extension connector. Must be used in conjunction with add-on beam kits - see page 484. Standard in Clear (CLR) glass. Frosted (FRST) glass is available at an upcharge.

- 66"W glass add-on extension kits include (1) 30"W extension panel, (1) 36"W extension panel, and (1) extra extension connector.
- 72"W fabric add-on extension kits include (2) 36"W extension panels and (1) extra extension connector.
- **For stability, panels may be stacked no higher than 42" above the floor.**

Required Specifications
Paint finish

Optional Specifications
Frosted glass

I INTELLI BEAM™

ADD-ON EXTENSION KITS

6"



12"



18"

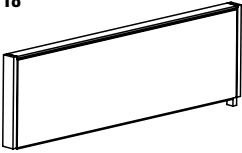

Add-On Extension Kit - Laminate

MODEL#	DIMENSIONS D x W x H	FREIGHT CLASS	WT/LBS.	CUBIC FT.	LIST PRICE
IBALE0636	2.87 x 36 x 6	85	9.35	.66	\$448
IBALE0642	2.87 x 42 x 6	85	10.78	.74	\$502
IBALE0648	2.87 x 48 x 6	70	12.21	.71	\$554
IBALE0654	2.87 x 54 x 6	70	13.65	.88	\$633
IBALE0660	2.87 x 60 x 6	70	15.08	.96	\$647
IBALE0666	2.87 x 66 x 6	85	17.26	1.25	\$843
IBALE0672	2.87 x 72 x 6	85	18.70	1.32	\$895
IBALE1236	2.87 x 36 x 12	65	26	1.12	\$448
IBALE1242	2.87 x 42 x 12	65	30	1.17	\$502
IBALE1248	2.87 x 48 x 12	60	38	1.23	\$554
IBALE1254	2.87 x 54 x 12	60	46	1.37	\$633
IBALE1260	2.87 x 60 x 12	60	52	1.44	\$647
IBALE1266	2.87 x 66 x 12	65	48	2.06	\$843
IBALE1272	2.87 x 72 x 12	65	52	2.24	\$895
IBALE1836	2.87 x 36 x 18	92.5	18.40	1.72	\$652
IBALE1842	2.87 x 42 x 18	92.5	19.70	1.72	\$730
IBALE1848	2.87 x 48 x 18	100	20.12	2.11	\$818
IBALE1854	2.87 x 54 x 18	92.5	21.75	2.15	\$895
IBALE1860	2.87 x 60 x 18	92.5	21.75	2.15	\$958
IBALE1866	2.87 x 66 x 18	92.5	33.90	3.20	\$1221
IBALE1872	2.87 x 72 x 18	92.5	36.80	3.44	\$1303

Laminate add-on extension kit attaches on top of an add-on beam kit of the same width. Includes laminate extension panel and (1) extension connector. Must be used in conjunction with add-on beam kits - see page 484.

- 66"W laminate add-on extension kits include (1) 30"W extension panel, (1) 36"W extension panel, and (1) extra extension connector.
- 72"W laminate add-on extension kits include (2) 36"W extension panels and (1) extra extension connector.
- **For stability, panels may be stacked no higher than 42" above the floor.**

Required Specifications

Paint finish
Laminate finish

PRIVACY GLASS KITS

MODEL# DIMENSIONS FREIGHT CLASS WT./LBS. CUBIC FT. LIST PRICE FRST ADD

D x W x H

IBPGK0636	2.87 x 36 x 6	125	3.58	.50	\$298	\$41
IBPGK0642	2.87 x 42 x 6	125	3.72	.60	\$319	\$29
IBPGK0648	2.87 x 48 x 6	125	3.72	.60	\$333	\$49
IBPGK0654	2.87 x 54 x 6	125	3.75	.62	\$353	\$61
IBPGK0660	2.87 x 60 x 6	125	3.75	.62	\$365	\$82
IBPGK0666	2.87 x 66 x 6	92.5	7.30	.65	\$616	\$70
IBPGK0672	2.87 x 72 x 6	125	7.44	1.20	\$636	\$57



6" H Privacy Glass*

6"H privacy glass kit attaches on top of any module of the same width. Privacy glass is integrated into the aluminum top trim. Attaching hardware is included. Standard in Clear (CLR) glass. Frosted (FRST) glass is available at an upcharge.

- 66"W privacy glass kits include (1) 30"W privacy glass screen and trim and (1) 36"W privacy glass screen and trim.
- 72"W privacy glass kits include (2) 36"W privacy glass screens and trims.
- **May be placed on Intelli Beam configuration of any height.**

IBPGK0936	2.87 x 36 x 9	125	3.58	.50	\$298	\$41
IBPGK0942	2.87 x 42 x 9	125	3.72	.60	\$319	\$29
IBPGK0948	2.87 x 48 x 9	60	36.72	.60	\$333	\$49
IBPGK0954	2.87 x 54 x 9	125	3.75	.62	\$353	\$62
IBPGK0960	2.87 x 60 x 9	125	3.75	.62	\$365	\$82
IBPGK0966	2.87 x 66 x 9	92.5	7.30	.65	\$616	\$70
IBPGK0972	2.87 x 72 x 9	125	7.44	1.20	\$636	\$57



9" H Privacy Glass*

9"H privacy glass kit attaches on top of any module of the same width. Privacy glass is integrated into the aluminum top trim. Attaching hardware is included. Standard in Clear (CLR) glass. Frosted (FRST) glass is available at an upcharge.

- 66"W privacy glass kits include (1) 30"W privacy glass screen and trim and (1) 36"W privacy glass screen and trim.
- 72"W privacy glass kits include (2) 36"W privacy glass screens and trims.
- **May be placed on Intelli Beam configuration of any height.**

IBPGK1236	2.87 x 36 x 12	125	3.58	.50	\$298	\$41
IBPGK1242	2.87 x 42 x 12	125	3.72	.60	\$319	\$29
IBPGK1248	2.87 x 48 x 12	125	3.72	.60	\$333	\$49
IBPGK1254	2.87 x 54 x 12	125	3.75	.62	\$353	\$62
IBPGK1260	2.87 x 60 x 12	125	3.75	.62	\$365	\$82
IBPGK1266	2.87 x 66 x 12	92.5	7.30	.65	\$616	\$70
IBPGK1272	2.87 x 72 x 12	125	7.44	1.20	\$636	\$57



12" H Privacy Glass*

12"H privacy glass kit attaches on top of any module of the same width. Privacy glass is integrated into the aluminum top trim. Attaching hardware is included. Standard in Clear (CLR) glass. Frosted (FRST) glass is available at an upcharge.

- 66"W privacy glass kits include (1) 30"W privacy glass screen and trim and (1) 36"W privacy glass screen and trim.
- 72"W privacy glass kits include (2) 36"W privacy glass screens and trims.
- **May be placed on Intelli Beam configuration of any height.**

IPBLERT24	-- x 24 x 2.87	70	1	.05	\$50	
IPBLERT30	-- x 30 x 2.87	70	1.20	.05	\$67	
IPBLERT36	-- x 36 x 2.87	70	1.50	.08	\$72	
IPBLERT42	-- x 42 x 2.87	70	2	.10	\$77	



End of Run Trim

End of run trim can be used to replace the trim included with Intelli Beam kits for a cleaner, finished look. Specify model # that corresponds with the overall height of the Intelli Beam + Extension Kits (if applicable).

Optional Specifications

Frosted glass*

LAMINATE END PANELS

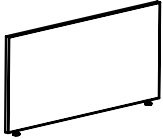

24"H Laminate End Panel

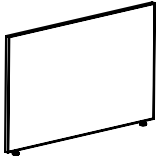

30"H Laminate End Panel

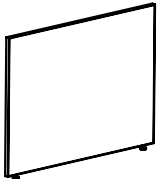

36"H Laminate End Panel

MODEL#	DIMENSIONS D x W x H	FREIGHT CLASS	WT/LBS.	CUBIC FT.	LIST PRICE
IBLEP2451	1 x 51 x 24	60	33.20	.95	\$265
IBLEP2463	1 x 63 x 24	60	33.20	.95	\$324

24"H laminate end panels attach to T-Legs and end trim at the end of any run of 24"H Intelli Beam stations.

- **Laminate end panel must be used with T-legs at the end of a run**
- Use 51" w panels for applications with 24" d surfaces on either side of Intelli Beam
- Use 63" w panels for applications with 30" d surfaces on either side of Intelli Beam

IBLEP3051	1 x 51 x 30	60	33.20	.95	\$331
IBLEP3063	1 x 63 x 30	60	33.20	.95	\$404

30"H laminate end panels attach to T-Legs and end trim at the end of any run of 30"H Intelli Beam stations.

- **Laminate end panel must be used with T-legs at the end of a run**
- Use 51" w panels for applications with 24" d surfaces on either side of Intelli Beam
- Use 63" w panels for applications with 30" d surfaces on either side of Intelli Beam

IBLEP3651	1 x 51 x 36	60	33.20	.95	\$401
IBLEP3663	1 x 63 x 36	60	33.20	.95	\$480

36"H laminate end panels attach to T-Legs and end trim at the end of any run of 36"H Intelli Beam stations.

- **Laminate end panel must be used with T-legs at the end of a run**
- Use 51" w panels for applications with 24" d surfaces on either side of Intelli Beam
- Use 63" w panels for applications with 30" d surfaces on either side of Intelli Beam

Required Specifications

Laminate finish

4-2-2 Wiring Schematic

8-Wire Shared Neutral

"2 + 2" - 2 Utility Circuits, 2 Dedicated

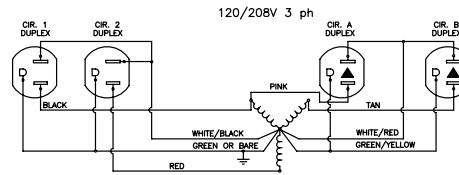
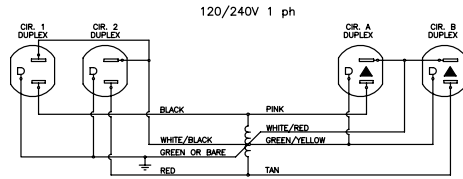

8 Wires

4 Lines (12 ga.)
2 Neutrals (10 ga.)
2 Grounds (12 ga.)

4 Circuits

2 Utility circuits
2 Dedicated Circuits

Receptacles

Duplex - Up to 12 duplex receptacles per circuit
(Up to 48 per infeed)

Specifications

System rated for connection to a grounded 120/240 V single phase, 20A, 60Hz or 120/208 V, 3 phase, 20A, 60Hz branch circuit for U.S. and 15A if product is marked with a C-UL Mark. Outlets rated 15A max.

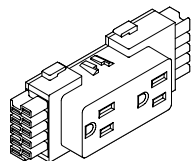

Duplex Receptacle

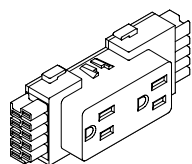

Controlled Circuit Duplex Receptacle

Black

IBE8RD1	1 x 1.5 x 2	70	.01	.01	\$32
IBE8RD2	1 x 1.5 x 2	70	.01	.01	\$32
IBE8RDA	1 x 1.5 x 2	70	.01	.01	\$32
IBE8RDB	1 x 1.5 x 2	70	.01	.01	\$32

White

IBE8RD1WT	1 x 1.5 x 2	70	.01	.01	\$46
IBE8RD2WT	1 x 1.5 x 2	70	.01	.01	\$46
IBE8RDAWT	1 x 1.5 x 2	70	.01	.01	\$46
IBE8RDBWT	1 x 1.5 x 2	70	.01	.01	\$46

Snaps into the power distribution housing located within the Intelli Beam raceway. White duplexes end in WT; all others are standard in Black. For 30"-60" Intelli Beam, specify (2) duplexes per side. For 66" and 72" Intelli Beam, you may specify up to (4) duplexes per side.

- IBE8RD1 / IBE8RD1WT - Circuit #1 (utility circuit)
- IBE8RD2 / IBE8RD2WT - Circuit #2 (utility circuit)
- IBE8RDA / IBE8RDAWT - Circuit A (dedicated circuit)
- IBE8RDB / IBE8RDBWT - Circuit B (dedicated circuit)

Black

IBE8RD1CA	1 x 1.5 x 2	70	.01	.01	\$36
IBE8RD2CA	1 x 1.5 x 2	70	.01	.01	\$36
IBE8RDACA	1 x 1.5 x 2	70	.01	.01	\$36
IBE8RDBCA	1 x 1.5 x 2	70	.01	.01	\$36

Snaps into power distribution housing located within the Intelli Beam raceway. To be used when California Title 24 energy savings standards are required. For 36"-60" Intelli Beam, specify (2) duplexes per side. For 66" and 72" Intelli Beam, you may specify up to (4) duplexes per side.

- IBE8RD1CA - Circuit #1 (utility circuit)
- IBE8RD2CA - Circuit #2 (utility circuit)
- IBE8RDACA - Circuit A (dedicated circuit)
- IBE8RDBCA - Circuit B (dedicated circuit)

INTELLI BEAM ELECTRICAL

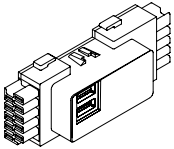

USB Duplex Module

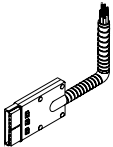

Base Feed

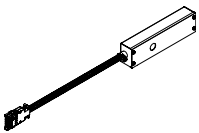

Base Feed - New York

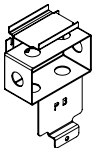

Hardwire Junction Box - Chicago

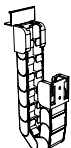

Cable Chain with Bracket

MODEL#	DIMENSIONS D x W x H	FREIGHT CLASS	WT/LBS.	CUBIC FT.	LIST PRICE
IBEUSB01W	-- x -- x --	70	.01	.01	\$194
IBEUSB01B	-- x -- x --	70	.01	.01	\$194

Snaps into the power distribution housing located within the Intelli Beam raceway. Can be used in lieu of a standard duplex receptacle. Specify model # ending in "W" for White and "B" for Black.

IBE8FR3PB	-- x 84 x --	60	4.90	.01	\$420
-----------	--------------	----	------	-----	--------------

Provides single power entry from floor or wall located building power supply. Connects to end of power distribution housing through any Intelli Beam Starter Kit. 84" length. Must be hardwired to the building power supply by a licensed electrician.

IBEENY2PB	-- x 32 x --	60	4.90	.01	\$406
-----------	--------------	----	------	-----	--------------

Provides single power entry from floor or wall located building power supply. Connects to end of power distribution housing through any Intelli Beam Starter Kit. Includes junction box for hardwire connection per NYC code. 32" length. Must be hardwired by a licensed electrician.

- Junction box is mounted within the vertical raceway on any Intelli Beam Starter Kit, in middle between Intelli Beam raceways.

IBEJBC1PB	-- x -- x --	60	4.90	.01	\$91
-----------	--------------	----	------	-----	-------------

To be retrofitted into open receptacle location. Gives access to one side at each location only. Customer supplies conduit, wiring, receptacle and face plate. Must be hardwired by a licensed electrician.

IBPBECH34	2 x 41 x 1	70	.60	.04	\$361
-----------	------------	----	-----	-----	--------------

Cable chain provides cables management from Intelli Beam to height adjustable table. Includes bracket to attach to bottom trim of Intelli Beam. Cables fit easily. Cable chain is 34 links long and includes mounting brackets. Includes two metal screws and two wood screws. Available in black only.

panels and components



Divide

page 450





Divide is a modular desk-mounted panel system that can be retro installed on many Global Desks. The panels can be vertically stacked to provide varying degrees of privacy. The panels are available in laminate or fabric tackboards as well as glazed panels that allow light to pass through. Divide's off-desk accessories help to organize paperwork and free up the workspace. Divide is offered in many laminate and fabric color options to complement any office environment.



Features and Benefits

- Available as Fabric, Glazed or Laminate partitioning panels in an array of heights and widths
- Easy to specify: choose the desired panel height and width and its corresponding height divider post(s)
- A built-in accessory management rail (on fabric and glazed panels) is designed to accommodate off-desk accessories for workspace organization.
- Laminate panels offer an optional wire access cutout at the bottom of each panel (order as SCP2)
- Laminate Transaction Tops are offered in various shapes and sizes, and are standard as either 1" thick or 1½" thick to match
- All Adaptabilities, Genoa, Halton and Zira laminate colors are offered as well as a wide variety of fabrics

GENERAL INFORMATION

- Divide is a desk mounted panel system that can be field installed at any time on many Global desks
- Vertical stacking of varying heights provides semi-private to private work areas
- Designed for use on the Adaptabilities, Genoa, Halton, and Zira laminate desk series', and may be retrofitted onto non-Global square edged product if necessary.
- Panels are available in 12", 18", 24" and 36" heights and can be stacked to produce heights of 24", 30", 36" and 42" for a virtually limitless variety of configurations
- Progressive, desk mounted partition system consisting of three major categories:
 - Divide posts - to support the partitions
 - Partitioning screens - a variety of widths and heights to create personalized privacy; offered in laminate, glaze or select fabrics
 - Transaction tops - laminate tops ideal for creating reception stations
- Global laminate and seating products are in compliance with stringent emission guidelines set out by the Greenguard Environmental Institute under the standards for low emitting products and materials. www.greenguard.org
- Model numbers reflect total width of panel and posts

DIVIDE POSTS

- Available in 6 standard heights:
 - 12" high - to create **semi-private** spaces and to support Transaction Tops
 - 18" high - to create **semi-private** spaces and to support Transaction Tops
 - 24" high - to create **semi-private** spaces
 - 30" high - to create **semi-private** spaces
 - 36" high - to create **private** spaces and to match the height of 36" high hutches and/or 65" high Adaptabilities, Genoa and Zira cabinets
 - 42" high - to create **private** spaces and to match the height of 42" high hutches and/or 72" high Zira cabinets
- Posts are field installed. Each plate divider includes: 1 post mounting plate, 1 threaded rod, 3 cover strips and 1 top cap plus mounting hardware (contains 8 screws, 1 washer, 1 locking nut). 2 divide posts are required per partitioning panel.
- Available in Black (**BK**) or Silver (**SI**) finish, please specify.

PARTITIONING SCREENS

- Available in 4 standard heights: 12", 18", 24" and 36" and can be used in combinations to create systems consisting of 12", 18", 24", 30", 36" and 42" heights.
- Available in 3 materials:
 - **Laminate** - available in all laminate colors used on Adaptabilities, Genoa, Halton and Zira (see right). Standard black accent edging at top and bottom. Optional wire access scoop cut-out is offered, centered at the bottom of the panel - order as **SCP2** after model #.
 - **Glazed** - choice of **clear, ribbed** or **frosted** glazing. Top and bottom rail standard in Black (**BK**) or Silver (**SI**), please specify. Top rail is designed to accommodate off-desk accessories. Glazed panels with document pass-through feature a 4" gap at the bottom.
 - **Fabric** - available in all Grade 1, 2, 3 and 4 panel fabrics and select Grade 1, 2, 3 and 4 seating fabrics (see right). Top and bottom rail standard in Black (**BK**) or Silver (**SI**), please specify. Top rail is designed to accommodate off-desk accessories.
- Filler panels are included with each Divide panel. To be used between two posts in a straight run from worksurface to worksurface.

TRANSACTION TOPS

- Tops are available in 1" or 1.5" thick thermally fused laminate
- Tops are sealed with Global's preferred edging in matching color
- Woodgrain surfaces feature edging in matching printed woodgrain
- Transaction tops are available with optional edges at no upcharge. Please specify (see right column).



A3 1" top, standard



AR 1" top, bicut edge



C3 1.5" top, standard



CR 1.5" top, bicut edge



CF 1.5" top, fluted edge

- Includes all necessary flat mounting plates and joining plates.
- Features pre-drilled locating holes to allow for quick alignment with the divide post
- Available with a radius cut on one or both ends (each radius adds a 6" overhang).
- Woodgrain surfaces feature edging with matching printed woodgrain
- Products specified with the high pressure laminate option are finished on the underside of the surface with a kraft paper backing.

LAMINATE AND EDGE FINISHES (laminate panels and transaction tops)

ACJ	Absolute Acajou	HGT	Hayden Grey
ASN	Asian Night	QTM	Quartered Mahogany
AWC	Avant Cherry	SOG	Storm Grey
AWH	Avant Honey	TFW	Tiger Fruitwood
BLK	Black	TWL	Tiger Walnut
BRC	Brushed Cobalt	WHE	Walnut Heights
CMB	Clear Maple	WHC	White Chocolate
DES	Dark Espresso	WCR	Winter Cherry
DWT	Designer White	WGY	Willow Grey

FABRICS (fabric screens)

- Grade 1:** Agate II
- Grade 2:** Jenny, Lola, Quilt, Urban
- Grade 3:** Anchorage, Brinx, Crescent, Imprint, Mariposa, Match, Merge, Renewal, Replay, Silhouette
- Grade 4:** Accent, Couture
- Momentum Grade 5:** Meander and Universe

D DIVIDE™ - NOTES

PLEASE NOTE:

- Divide screens cannot be centered between two back to back worksurfaces.
- Screens must be installed on one worksurface or the other.
- Divide cannot be used with Adaptabilities reception units.
- When panels are mounted on a 30" deep worksurface from Adaptabilities, Genoa or Zira, please specify 29" wide panel

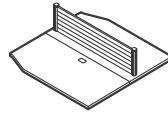

Correct Installation

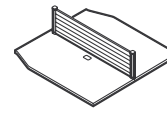

Incorrect Installation

HOW TO ORDER DIVIDE SCREENS

example: DTB 1236 GN31

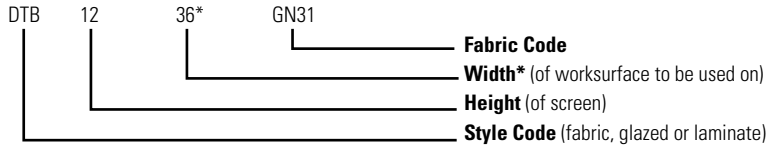

*NOTE: Number denotes width of worksurface to use - please see dimensions in price book for actual dimensions of the screen.

PARTS AND COMPONENTS

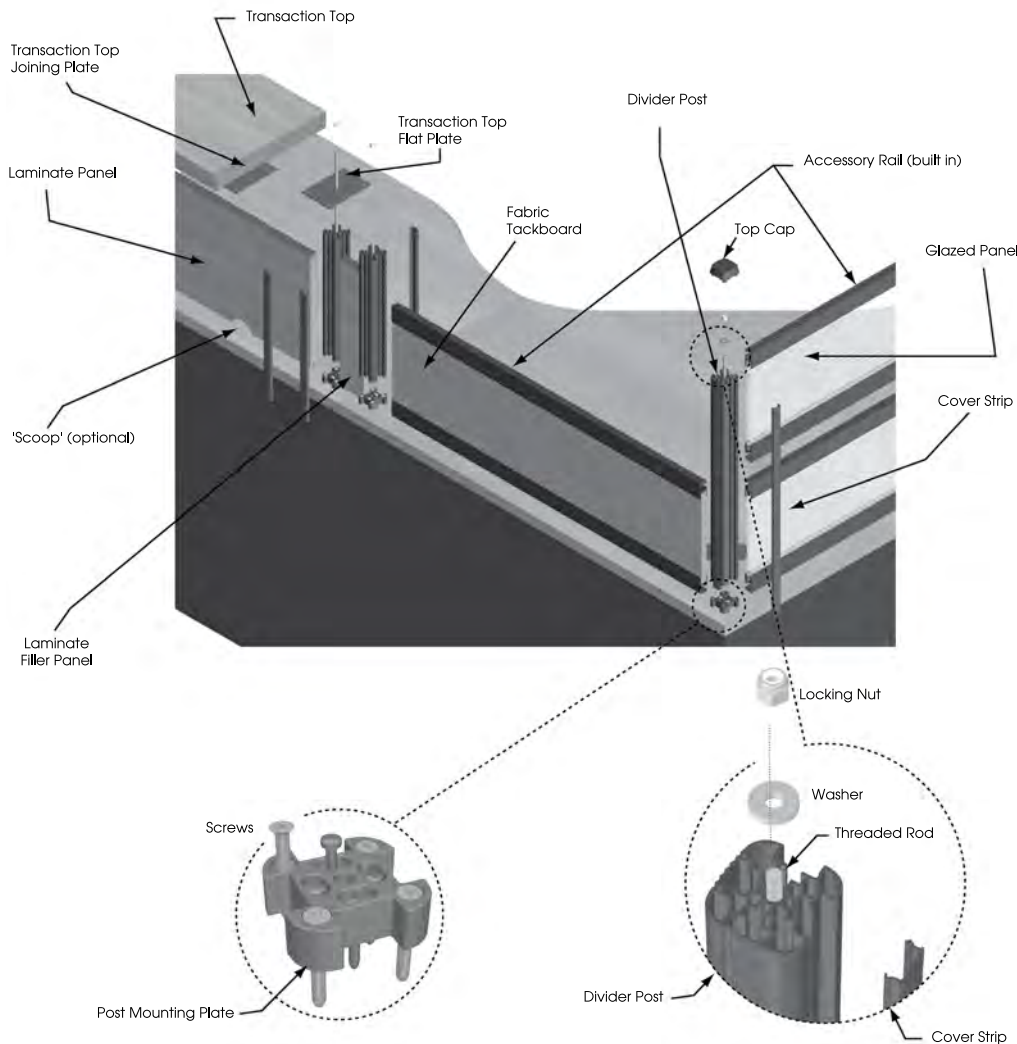

INSTALLATION IS AS SIMPLE AS 1...2...3

- 1) Attach the threaded **Post Mounting Plate** with enclosed screws to the top side of the worksurface.
- 2) **Divider Post** is bolted to the Mounting Plate.
- 3) **Top Cap** is attached to the top of the Divider Post.

12”H System

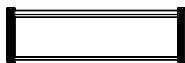

12” panel



12” raised panel

18”H System



18” panel

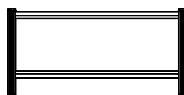

18” raised panel

24”H System



24” panel

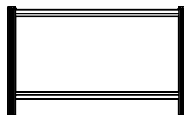

24” raised panel

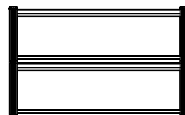

(2) 12” panels

30”H System

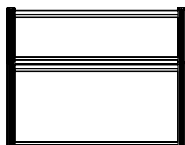

12” panel + 18” panel

36”H System

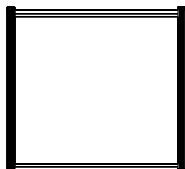

36” panel

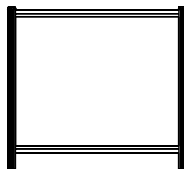

36” raised panel

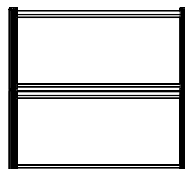

(2) 18” panels

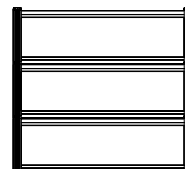

(3) 12” panels

42”H System

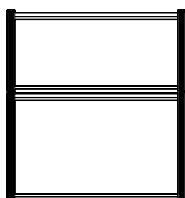

18” panel + 24” panel

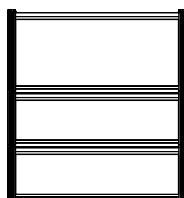

(1) 18” panel
(2) 12” panels

FABRIC PANELS

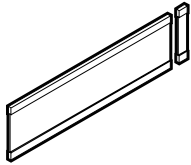

Fabric Panel - 12" High

MODEL#	DIMENSIONS D x W x H	FREIGHT CLASS	WT/LBS.	CUBIC FT.	GR. 1	GR. 2	GR. 3	GR. 4	GR. 5
DTB1220	.68 x 14.8 x 12	92.5	3	.30	\$201	\$224	\$243	\$272	\$312
DTB1224	.68 x 18.9 x 12	85	4	.30	\$211	\$233	\$252	\$279	\$319
DTB1229	.68 x 24.5 x 12	92.5	4	.40	\$223	\$248	\$264	\$294	\$332
DTB1230	.68 x 24.8 x 12	85	5	.40	\$223	\$248	\$264	\$294	\$332
DTB1236	.68 x 30.8 x 12	85	5	.40	\$248	\$271	\$289	\$317	\$356
DTB1242	.68 x 36.8 x 12	85	6	.50	\$289	\$312	\$329	\$357	\$397
DTB1248	.68 x 42.8 x 12	92.5	7	.60	\$313	\$334	\$353	\$380	\$420
DTB1260	.68 x 54.8 x 12	85	9	.70	\$334	\$358	\$375	\$404	\$443
DTB1266	.68 x 60.8 x 12	85	10	.80	\$354	\$376	\$396	\$423	\$463
DTB1272	.68 x 66.8 x 12	85	11	.80	\$376	\$400	\$418	\$445	\$485

Features built-in accessory rail. Includes matching filler panel. Ships 1 set per carton. **Specify DTB1229 for panels placed along the depth side of a 30" deep worksurface. Top and bottom rail are offered in Black (BK) or Silver (SI), please specify.**

- Model # depicts size of worksurface to be used on - see NOTES on page 504 for additional ordering information.
- When specifying a Grade 1, 2, 3, 4 or 5 seating fabric, please note fabric pattern will run horizontally
- Divider Post **MUST** be ordered separately. Two posts are required per panel.

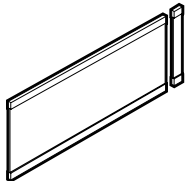

Fabric Panel - 18" High

DTB1820	.68 x 14.8 x 18	85	4	.30	\$223	\$248	\$264	\$294	\$332
DTB1824	.68 x 18.9 x 18	85	5	.40	\$235	\$257	\$276	\$302	\$342
DTB1829	.68 x 24.5 x 18	85	6	.50	\$248	\$271	\$289	\$317	\$356
DTB1830	.68 x 24.8 x 18	85	6	.50	\$248	\$271	\$289	\$317	\$356
DTB1836	.68 x 30.8 x 18	92.5	7	.60	\$289	\$312	\$329	\$357	\$397
DTB1842	.68 x 36.8 x 18	92.5	8	.70	\$315	\$337	\$354	\$382	\$421
DTB1848	.68 x 42.8 x 18	85	10	.80	\$334	\$358	\$375	\$404	\$443
DTB1860	.68 x 54.8 x 18	85	12	.90	\$354	\$376	\$396	\$423	\$463
DTB1866	.68 x 60.8 x 18	85	14	1	\$376	\$400	\$418	\$445	\$485
DTB1872	.68 x 66.8 x 18	85	14	1.10	\$421	\$444	\$463	\$491	\$530

Features built-in accessory rail. Includes matching filler panel. Ships 1 set per carton. **Specify DTB1829 for panels placed along the depth side of a 30" deep worksurface. Top and bottom rail are offered in Black (BK) or Silver (SI), please specify.**

- Model # depicts size of worksurface to be used on - see NOTES on page 504 for additional ordering information.
- When specifying a Grade 1, 2, 3, 4 or 5 seating fabric, please note fabric pattern will run horizontally
- Divider Post **MUST** be ordered separately. Two posts are required per panel.

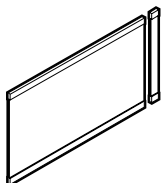

Fabric Panel - 24" High

DTB2420	.68 x 14.8 x 24	92.5	4	.40	\$248	\$271	\$289	\$317	\$356
DTB2424	.68 x 18.9 x 24	100	4	.50	\$248	\$271	\$289	\$317	\$356
DTB2429	.68 x 24.5 x 24	92.5	6	.60	\$289	\$312	\$329	\$357	\$397
DTB2430	.68 x 24.8 x 24	92.5	6	.60	\$289	\$312	\$329	\$357	\$397
DTB2436	.68 x 30.8 x 24	92.5	7	.70	\$313	\$334	\$353	\$380	\$420
DTB2442	.68 x 36.8 x 24	92.5	8	.80	\$334	\$358	\$375	\$404	\$443
DTB2448	.68 x 42.8 x 24	92.5	9	.90	\$354	\$376	\$396	\$423	\$463
DTB2460	.68 x 54.8 x 24	92.5	11	1.10	\$376	\$400	\$418	\$445	\$485
DTB2466	.68 x 60.8 x 24	92.5	12	1.20	\$421	\$444	\$463	\$491	\$530
DTB2472	.68 x 66.8 x 24	92.5	14	1.40	\$458	\$482	\$501	\$527	\$568

Features built-in accessory rail. Includes matching filler panel. Ships 1 set per carton. **Specify DTB2429 for panels placed along the depth side of a 30" deep worksurface. Top and bottom rail are offered in Black (BK) or Silver (SI), please specify.**

- Model # depicts size of worksurface to be used on - see NOTES on page 504 for additional ordering information.
- When specifying a Grade 1, 2, 3, 4 or 5 seating fabric, please note fabric pattern will run horizontally
- Divider Post **MUST** be ordered separately. Two posts are required per panel.

Required Specifications

Fabric
Rail Finish

FABRIC PANELS

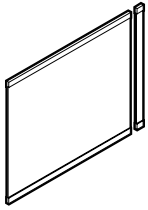

Fabric Panel - 36" High*

MODEL#	DIMENSIONS	FREIGHT CLASS	WT/LBS.	CUBIC FT.	GR.1	GR.2	GR.3	GR.4	GR.5	
D x W x H										
DTB3620	.68 x 14.8 x 36	92.5	6	.60	\$289	\$312	\$329	\$357	\$397	
DTB3624	.68 x 18.9 x 36	92.5	7	.70	\$298	\$322	\$339	\$367	\$406	
DTB3629	.68 x 24.5 x 36	92.5	9	.90	\$313	\$334	\$353	\$380	\$420	
DTB3630	.68 x 24.8 x 36	92.5	9	.90	\$313	\$334	\$353	\$380	\$420	
DTB3636	.68 x 30.8 x 36	92.5	10	1	\$334	\$358	\$375	\$404	\$443	
DTB3642	.68 x 36.8 x 36	92.5	12	1.20	\$354	\$376	\$396	\$423	\$463	
DTB3648	.68 x 42.8 x 36	92.5	14	1.30	\$376	\$400	\$418	\$445	\$485	
DTB3660	.68 x 54.8 x 36	92.5	17	1.60	\$421	\$444	\$463	\$491	\$530	
DTB3666	.68 x 60.8 x 36	92.5	19	1.80	\$458	\$482	\$501	\$527	\$568	
DTB3672	.68 x 66.8 x 36	92.5	21	1.90	\$495	\$519	\$535	\$563	\$603	

Features built-in accessory rail. Includes matching filler panel. Ships 1 set per carton. **Specify DTB3629 for panels placed along the depth side of a 30" deep worksurface. Top and bottom rail are offered in Black (BK) or Silver (SI), please specify.**

- Model # depicts size of worksurface to be used on - see NOTES on page 504 for additional ordering information.
- When specifying a Grade 1, 2, 3, 4 or 5 seating fabric, please note fabric pattern will run horizontally
- Divider Post **MUST** be ordered separately. Two posts are required per panel.

GLAZED PANELS

LIST PRICE

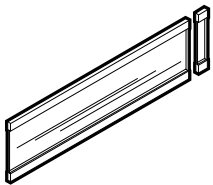

Glazed Panel - 12" High**

DGP1220	.68 x 14.8 x 12	125	2	.30	\$199
DGP1224	.68 x 18.9 x 12	92.5	3	.30	\$211
DGP1229	.68 x 24.5 x 12	125	3	.40	\$251
DGP1230	.68 x 24.8 x 12	92.5	4	.40	\$251
DGP1236	.68 x 30.8 x 12	92.5	4	.40	\$291
DGP1242	.68 x 36.8 x 12	92.5	5	.50	\$331
DGP1248	.68 x 42.8 x 12	100	5	.60	\$391
DGP1260	.68 x 54.8 x 12	92.5	7	.70	\$458
DGP1266	.68 x 60.8 x 12	100	7	.80	\$502
DGP1272	.68 x 66.8 x 12	92.5	8	.80	\$543

Features built-in accessory rail. Includes matching filler panel. Ships 1 set per carton. **Specify DGP1229 for panels placed along the depth side of a 30" deep worksurface. Top and bottom rail are offered in Black (BK) or Silver (SI), please specify.**

- Model # depicts size of worksurface to be used on - see NOTES on page 504 for additional ordering information.
- Divide Post **MUST** be ordered separately. Two posts are required per panel.
- Glazing is available in Frosted (**GF**), Clear (**GC**) or Ribbed (**RG**).

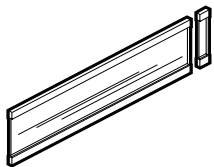

Glazed Panel - 12" High, Raised**

DRGP1220	.68 x 14.8 x 12	60	2	.02	\$176
DRGP1224	.68 x 18.9 x 12	60	3	.03	\$204
DRGP1229	.68 x 24.5 x 12	60	3	.03	\$241
DRGP1230	.68 x 24.8 x 12	60	4	.03	\$241
DRGP1236	.68 x 30.8 x 12	60	4	.04	\$283
DRGP1242	.68 x 36.8 x 12	60	5	.05	\$320
DRGP1248	.68 x 42.8 x 12	60	5	.05	\$380
DRGP1260	.68 x 54.8 x 12	60	7	.07	\$450
DRGP1266	.68 x 60.8 x 12	60	7	.07	\$491
DRGP1272	.68 x 66.8 x 12	60	8	.08	\$533

4" gap at bottom. Features built-in accessory rail. Includes matching filler panel. Ships 1 set per carton. Raised glazed panels to be offered on the lower level only. **Specify DRGP1229 for panels placed along the depth side of a 30" deep worksurface. Top and bottom rail are offered in Black (BK) or Silver (SI), please specify.**

- Model # depicts size of worksurface to be used on - see NOTES on page 504 for additional ordering information.
- Divide Post **MUST** be ordered separately. Two posts are required per panel.
- Glazing is available in Frosted (**GF**), Clear (**GC**) or Ribbed (**RG**).

Required Specifications

- Fabric*
- Glaze**
- Rail Finish

GLAZED PANELS

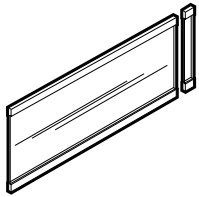

Glazed Panel - 18" High

MODEL#	DIMENSIONS D x W x H	FREIGHT CLASS	WT./LBS.	CUBIC FT.	LIST PRICE
DGP1820	.68 x 14.8 x 18	92.5	3	.30	\$221
DGP1824	.68 x 18.9 x 18	125	3	.40	\$239
DGP1829	.68 x 24.5 x 18	100	4	.50	\$280
DGP1830	.68 x 24.8 x 18	100	4	.50	\$280
DGP1836	.68 x 30.8 x 18	100	5	.60	\$324
DGP1842	.68 x 36.8 x 18	125	5	.70	\$361
DGP1848	.68 x 42.8 x 18	125	6	.80	\$434
DGP1860	.68 x 54.8 x 18	100	8	.90	\$518
DGP1866	.68 x 60.8 x 18	100	8	1	\$560
DGP1872	.68 x 66.8 x 18	100	9	1.10	\$606

Features built-in accessory rail. Includes matching filler panel. Ships 1 set per carton. **Specify DGP1829 for panels placed along the depth side of a 30" deep worksurface. Top and bottom rail are offered in Black (BK) or Silver (SI), please specify.**

- Model # depicts size of worksurface to be used on - see NOTES on page 504 for additional ordering information.
- Divide Post **MUST** be ordered separately. Two posts are required per panel.
- Glazing is available in Frosted (GF), Clear (GC) or Ribbed (RG).

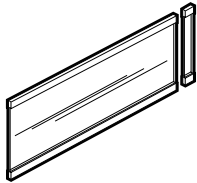

Glazed Panel - 18" High, Raised

DRGP1820	.68 x 14.8 x 18	60	3	.03	\$204
DRGP1824	.68 x 18.9 x 18	60	3	.04	\$232
DRGP1829	.68 x 24.5 x 18	60	4	.05	\$269
DRGP1830	.68 x 24.8 x 18	60	4	.05	\$269
DRGP1836	.68 x 30.8 x 18	60	5	.06	\$315
DRGP1842	.68 x 36.8 x 18	60	5	.06	\$352
DRGP1848	.68 x 42.8 x 18	60	6	.07	\$422
DRGP1860	.68 x 54.8 x 18	60	8	.09	\$505
DRGP1866	.68 x 60.8 x 18	100	8	1	\$547
DRGP1872	.68 x 66.8 x 18	100	9	1.10	\$593

4" gap at bottom. Features built-in accessory rail. Includes matching filler panel. Ships 1 set per carton. Raised glazed panels to be offered on the lower level only. **Specify DRGP1829 for panels placed along the depth side of a 30" deep worksurface. Top and bottom rail are offered in Black (BK) or Silver (SI), please specify.**

- Model # depicts size of worksurface to be used on - see NOTES on page 504 for additional ordering information.
- Divide Post **MUST** be ordered separately. Two posts are required per panel.
- Glazing is available in Frosted (GF), Clear (GC) or Ribbed (RG).

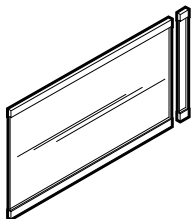

Glazed Panel - 24" High

DGP2420	.68 x 14.8 x 24	125	3	.40	\$239
DGP2424	.68 x 18.9 x 24	100	4	.50	\$268
DGP2429	.68 x 24.5 x 24	125	4	.60	\$322
DGP2430	.68 x 24.8 x 24	100	5	.60	\$322
DGP2436	.68 x 30.8 x 24	125	5	.70	\$371
DGP2442	.68 x 36.8 x 24	125	6	.80	\$421
DGP2448	.68 x 42.8 x 24	125	7	.90	\$495
DGP2460	.68 x 54.8 x 24	100	9	1.10	\$601
DGP2466	.68 x 60.8 x 24	100	10	1.20	\$656
DGP2472	.68 x 66.8 x 24	125	10	1.40	\$706

Features built-in accessory rail. Includes matching filler panel. Ships 1 set per carton. **Specify DGP2429 for panels placed along the depth side of a 30" deep worksurface. Top and bottom rail are offered in Black (BK) or Silver (SI), please specify.**

- Model # depicts size of worksurface to be used on - see NOTES on page 504 for additional ordering information.
- Divide Post **MUST** be ordered separately. Two posts are required per panel.
- Glazing is available in Frosted (GF), Clear (GC) or Ribbed (RG).

Required Specifications

Fabric
Finish

Optional Specifications

Glazing

GLAZED PANELS

MODEL# DIMENSIONS FREIGHT CLASS WT./LBS. CUBIC FT. LIST PRICE

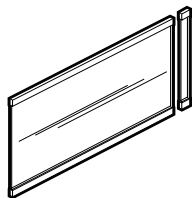

Glazed Panel - 24" High, Raised

	D x W x H				
DRGP2420	.68 x 14.8 x 24	60	3	.04	\$232
DRGP2424	.68 x 18.9 x 24	60	4	.05	\$260
DRGP2429	.68 x 24.5 x 24	60	4	.06	\$311
DRGP2430	.68 x 24.8 x 24	60	5	.06	\$311
DRGP2436	.68 x 30.8 x 24	60	5	.07	\$362
DRGP2442	.68 x 36.8 x 24	60	6	.08	\$413
DRGP2448	.68 x 42.8 x 24	60	7	.09	\$482
DRGP2460	.68 x 54.8 x 24	100	9	1.10	\$588
DRGP2466	.68 x 60.8 x 24	100	10	1.20	\$644
DRGP2472	.68 x 66.8 x 24	125	10	1.30	\$695

4" gap at bottom. Features built-in accessory rail. Includes matching filler panel. Ships 1 set per carton. Raised glazed panels to be offered on the lower level only. **Specify DRGP2429 for panels placed along the depth side of a 30" deep worksurface. Top and bottom rail are offered in Black (BK) or Silver (SI), please specify.**

- Model # depicts size of worksurface to be used on - see NOTES on page 504 for additional ordering information.
- Divide Post **MUST** be ordered separately. Two posts are required per panel.
- Glazing is available in Frosted (GF), Clear (GC) or Ribbed (RG).

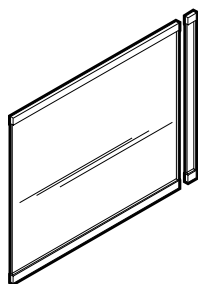

Glazed Panel - 36" High

DGP3620	.68 x 14.8 x 36	125	4	.60	\$291
DGP3624	.68 x 18.9 x 36	150	4	.70	\$322
DGP3629	.68 x 24.5 x 36	150	5	.90	\$384
DGP3630	.68 x 24.8 x 36	125	6	.90	\$384
DGP3636	.68 x 30.8 x 36	125	7	1	\$454
DGP3642	.68 x 36.8 x 36	125	8	1.20	\$518
DGP3648	.68 x 42.8 x 36	125	9	1.30	\$606
DGP3660	.68 x 54.8 x 36	125	11	1.60	\$731
DGP3666	.68 x 60.8 x 36	125	12	1.80	\$797
DGP3672	.68 x 66.8 x 36	125	13	1.90	\$861

Features built-in accessory rail. Includes matching filler panel. Ships 1 set per carton. **Specify DGP3629 for panels placed along the depth side of a 30" deep worksurface. Top and bottom rail are offered in Black (BK) or Silver (SI), please specify.**

- Model # depicts size of worksurface to be used on - see NOTES on page 504 for additional ordering information.
- Divide Post **MUST** be ordered separately. Two posts are required per panel.
- Glazing is available in Frosted (GF), Clear (GC) or Ribbed (RG).

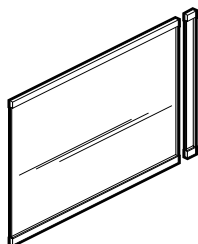

Glazed Panel - 36" High, Raised

DRGP3620	.68 x 14.8 x 36	60	4	.06	\$283
DRGP3624	.68 x 18.9 x 36	60	4	.07	\$311
DRGP3629	.68 x 24.5 x 36	60	5	.08	\$375
DRGP3630	.68 x 24.8 x 36	60	6	.08	\$375
DRGP3636	.68 x 30.8 x 36	125	7	1	\$445
DRGP3642	.68 x 36.8 x 36	125	8	1.10	\$505
DRGP3648	.68 x 42.8 x 36	125	9	1.30	\$593
DRGP3660	.68 x 54.8 x 36	125	11	1.60	\$713
DRGP3666	.68 x 60.8 x 36	125	12	1.70	\$778
DRGP3672	.68 x 66.8 x 36	125	13	1.90	\$843

4" gap at bottom. Features built-in accessory rail. Includes matching filler panel. Ships 1 set per carton. Raised glazed panels to be offered on the lower level only. **Specify DRGP3629 for panels placed along the depth side of a 30" deep worksurface. Top and bottom rail are offered in Black (BK) or Silver (SI), please specify.**

- Model # depicts size of worksurface to be used on - see NOTES on page 504 for additional ordering information.
- Divide Post **MUST** be ordered separately. Two posts are required per panel.
- Glazing is available in Frosted (GF), Clear (GC) or Ribbed (RG).

Required Specifications
Finish

Optional Specifications
Glazing

LAMINATE PANELS

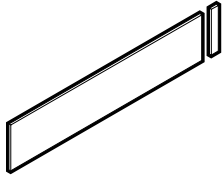

Laminate Panel - 12" High

MODEL#	DIMENSIONS	FREIGHT CLASS	WT/LBS.	CUBIC FT.	LIST PRICE
D x W x H					
DLP1220	.68 x 14.8 x 12	70	5	.30	\$65
DLP1224	.68 x 18.9 x 12	70	5	.30	\$76
DLP1229	.68 x 24.5 x 12	70	7	.40	\$97
DLP1230	.68 x 24.8 x 12	70	7	.40	\$97
DLP1236	.68 x 30.8 x 12	70	8	.40	\$107
DLP1242	.68 x 36.8 x 12	70	10	.50	\$122
DLP1248	.68 x 42.8 x 12	70	11	.60	\$137
DLP1260	.68 x 54.8 x 12	70	14	.70	\$148
DLP1266	.68 x 60.8 x 12	70	16	.80	\$163
DLP1272	.68 x 66.8 x 12	70	17	.80	\$184

Includes matching filler panel. Scoop option (**SCP2**) available, **ADD \$31.00**. Ships 1 set per carton. **Specify DLP1229 for panels placed along the depth side of a 30" deep worksurface.**

- Model # depicts size of worksurface to be used on - see NOTES on page 504 for additional ordering information.
- Divide Post **MUST** be ordered separately. Two posts are required per panel.

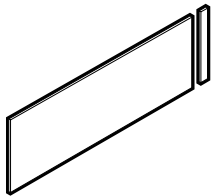

Laminate Panel - 18" High

DLP1820	.68 x 14.8 x 18	65	7	.30	\$78
DLP1824	.68 x 18.9 x 18	70	8	.40	\$89
DLP1829	.68 x 24.5 x 18	70	10	.50	\$105
DLP1830	.68 x 24.8 x 18	70	10	.50	\$105
DLP1836	.68 x 30.8 x 18	70	12	.60	\$120
DLP1842	.68 x 36.8 x 18	70	15	.70	\$137
DLP1848	.68 x 42.8 x 18	70	17	.80	\$159
DLP1860	.68 x 54.8 x 18	65	21	.90	\$173
DLP1866	.68 x 60.8 x 18	65	23	1	\$191
DLP1872	.68 x 66.8 x 18	65	25	1.10	\$211

Includes matching filler panel. Scoop option (**SCP2**) available, **ADD \$31.00**. Ships 1 set per carton. **Specify DLP1829 for panels placed along the depth side of a 30" deep worksurface.**

- Model # depicts size of worksurface to be used on - see NOTES on page 504 for additional ordering information.
- Divide Post **MUST** be ordered separately. Two posts are required per panel.

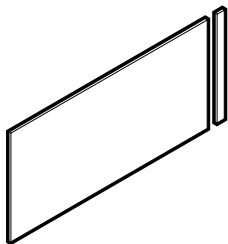

Laminate Panel - 24" High

DLP2420	.68 x 14.8 x 24	65	9	.40	\$89
DLP2424	.68 x 18.9 x 24	70	11	.50	\$96
DLP2429	.68 x 24.5 x 24	70	13	.60	\$120
DLP2430	.68 x 24.8 x 24	70	13	.60	\$120
DLP2436	.68 x 30.8 x 24	65	16	.70	\$132
DLP2442	.68 x 36.8 x 24	65	19	.80	\$154
DLP2448	.68 x 42.8 x 24	65	22	.90	\$176
DLP2460	.68 x 54.8 x 24	65	28	1.10	\$199
DLP2466	.68 x 60.8 x 24	65	30	1.20	\$220
DLP2472	.68 x 66.8 x 24	65	33	1.40	\$242

Includes matching filler panel. Scoop option (**SCP2**) available, **ADD \$31.00**. Ships 1 set per carton. **Specify DLP2429 for panels placed along the depth side of a 30" deep worksurface.**

- Model # depicts size of worksurface to be used on - see NOTES on page 504 for additional ordering information.
- Divide Post **MUST** be ordered separately. Two posts are required per panel.

Required Specifications

- Glaze (Glazed Panels)
- Finish (Laminate Panels)
- Rail Finish (glazed panels)

LAMINATE PANELS

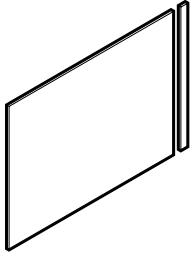

Laminate Panel - 36" High

MODEL# DIMENSIONS FREIGHT CLASS WT/LBS. CUBIC FT. LIST PRICE

	D x W x H				
DLP3620	.68 x 14.8 x 36	70	13	.60	\$109
DLP3624	.68 x 18.9 x 36	65	16	.70	\$120
DLP3629	.68 x 24.5 x 36	70	20	.90	\$146
DLP3630	.68 x 24.8 x 36	70	20	.90	\$146
DLP3636	.68 x 30.8 x 36	65	24	1	\$170
DLP3642	.68 x 36.8 x 36	65	28	1.20	\$196
DLP3648	.68 x 42.8 x 36	65	33	1.30	\$220
DLP3660	.68 x 54.8 x 36	65	41	1.60	\$254
DLP3666	.68 x 60.8 x 36	65	45	1.80	\$280
DLP3672	.68 x 66.8 x 36	65	50	1.90	\$308

Includes matching filler panel. Scoop option (**SCP2**) available, **ADD \$31.00**. Ships 1 set per carton. **Specify DLP3629 for panels placed along the depth side of a 30" deep worksurface.**

- Model # depicts size of worksurface to be used on - see *NOTES* on page 504 for additional ordering information.
- Divide Post **MUST** be ordered separately. Two posts are required per panel.

Required Specifications

Finish

ACCESSORY RAIL ORGANIZERS

MODEL# DIMENSIONS FREIGHT CLASS WT/LBS. CUBIC FT. LIST PRICE

D x W x H

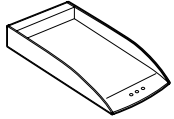

Paper Tray

EEPT	14 x 9.5 x 2	70	.90	.18	\$51
------	--------------	----	-----	-----	-------------

Mounts on the off-desk accessory rail. ABS plastic.
 • Cannot be used on Divide Laminate Panels
 • MUST Specify Black (**BLK**) or Frosted (**FR**) finish.

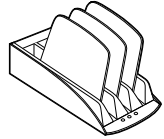

Slanted File Holder

EESFH	12.5 x 7.25 x 7	70	1.10	.15	\$66
-------	-----------------	----	------	-----	-------------

Mounts on the off-desk accessory rail. ABS plastic.
 • Cannot be used on Divide Laminate Panels
 • MUST Specify Black (**BLK**) or Frosted (**FR**) finish.

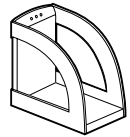

Binder Holder

EEBH	10.5 x 5 x 9	70	.50	.34	\$42
------	--------------	----	-----	-----	-------------

Mounts on the off-desk accessory rail. ABS plastic.
 • Cannot be used on Divide Laminate Panels
 • MUST Specify Black (**BLK**) or Frosted (**FR**) finish.

Required Specifications

Finish

DIVIDE POSTS



Divide Post

MODEL# DIMENSIONS FREIGHT CLASS WT/LBS. CUBIC FT. LIST PRICE

D x W x H

DPOST12	1.68 x 1.68 x 12	70	2	.10	\$90
DPOST18	1.68 x 1.68 x 18	70	2	.10	\$122
DPOST24	1.68 x 1.68 x 24	60	3	.10	\$160
DPOST30	1.68 x 1.68 x 30	60	4	.10	\$221
DPOST36	1.68 x 1.68 x 36	70	4	.20	\$254
DPOST42	1.68 x 1.68 x 42	65	5	.20	\$283

For supporting panels. Includes one post mounting plate, one top cap, three cover strips, threaded rod and all mounting hardware. Installation templates are supplied with each project. Black (BK) or Silver (SI) - please specify.

- Requires 2 Divider Posts per panel
- Divider Post is mounted 1 1/16" from worksurface edge.



Post-to-Wall Filler Strip

DFS12	1.43 x .75 x 12	150	2	.50	\$49
DFS18	1.43 x .75 x 18	150	2	.50	\$49
DFS24	1.43 x .75 x 24	150	2	.50	\$49
DFS30	1.43 x .75 x 30	150	2	.50	\$52
DFS36	1.43 x .75 x 36	150	2	.50	\$52
DFS42	1.43 x .75 x 42	150	3	.60	\$52

Used to fill gap between Divider Post and an adjacent wall, wardrobe unit, or hutch. Ships 1 per carton. Black only.

Required Specifications

Finish

TRANSACTION TOPS

D x W x H

- To order a radius end on one side of a transaction top, add the suffix "D" to the model number (ex. DATT30D). Add a **15% upcharge**.
- To order a radius end on both sides of a transaction top, add the suffix "DD" to the model number (ex. DATT30DD). Add a **20% upcharge**.
- Each radius end adds a 6" overhang per side (see illustrations below).

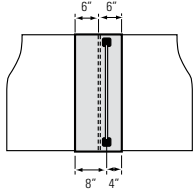

Transaction top is offset 6" from edge of worksurface in both directions.

Transaction top is offset 4" from the center of divider post towards the inside and 8" towards the outside.

Transaction Top Offset

- 4" from the center of the Divider Post to the inside of worksurface
- 8" from the center of the Divider Post to the outside of worksurface

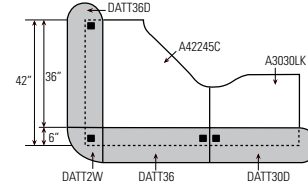

Two Way Connector Transaction Top (DATT2W/DCTT2W)

Use with a corner worksurface to link transaction tops together.

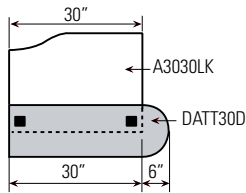

Radius End Transaction Top - one side

Add suffix "D" to model number for radius end on one side.

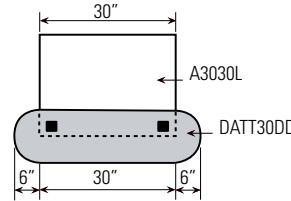

Radius End Transaction Top - two sides

Add suffix "DD" to model number for radius end on both sides.

STRAIGHT TRANSACTION TOPS

MODEL# DIMENSIONS FREIGHT CLASS WT./LBS. CUBIC FT. LIST PRICE

DATT14	12 x 14 x 1	65	7	.30	\$198
DATT18	12 x 18 x 1	70	8	.40	\$198
DATT20	12 x 20 x 1	70	9	.50	\$198
DATT23	12 x 23 x 1	70	10	.50	\$224
DATT24	12 x 24 x 1	70	10	.50	\$224
DATT29	12 x 29 x 1	70	12	.60	\$240
DATT30	12 x 30 x 1	70	12	.60	\$240
DATT36	12 x 36 x 1	70	14	.70	\$254
DATT42	12 x 42 x 1	70	16	.80	\$268
DATT48	12 x 48 x 1	70	18	.90	\$268
DATT54	12 x 54 x 1	70	21	1	\$303
DATT60	12 x 60 x 1	70	23	1.10	\$303
DATT66	12 x 66 x 1	70	25	1.20	\$338
DATT72	12 x 72 x 1	70	27	1.30	\$338



Straight Transaction Top - 1" thick

12" deep x 1" thick top. Includes all necessary Flat Plates, Joining Plates and screws. Thickness matches Adaptabilities, Genoa, Halton and Zira Series worksurfaces. Ships 1 set per carton.

- Add "D" to model number for radius end on one side, ADD **15% upcharge**.
- Add "DD" to model number for radius end on both sides, ADD **20% upcharge**.
- Each radius adds 6" overhang per side.

Required Specifications

Laminate Finish
Edge Detail

Optional Specifications

Radius End

TRANSACTION TOPS

MODEL# DIMENSIONS FREIGHT CLASS WT/LBS. CUBIC FT. LIST PRICE

D x W x H

DCTT14	12 x 14 x 1.5	60	9	.30	\$274
DCTT18	12 x 18 x 1.5	65	11	.40	\$274
DCTT20	12 x 14.8 x 1.5	65	12	.50	\$274
DCTT23	12 x 23 x 1.5	65	14	.50	\$319
DCTT24	12 x 18.9 x 1.5	65	14	.50	\$319
DCTT29	12 x 24.5 x 1.5	65	17	.60	\$340
DCTT30	12 x 30 x 1.5	65	17	.60	\$340
DCTT36	12 x 36 x 1.5	65	20	.70	\$356
DCTT42	12 x 42 x 1.5	65	23	.80	\$356
DCTT48	12 x 48 x 1.5	65	26	.90	\$356
DCTT54	12 x 54 x 1.5	65	29	1	\$405
DCTT60	12 x 60 x 1.5	65	32	1.10	\$405
DCTT66	12 x 66 x 1.5	65	35	1.20	\$444
DCTT72	12 x 72 x 1.5	65	38	1.30	\$444



Straight Transaction Top - 1½" thick

12" deep x 1½" thick top. Includes all necessary Flat Plates, Joining Plates and screws. Thickness matches Zira worksurfaces. Ships 1 set per carton.

- Add "D" to model number for radius end on one side, ADD **15% upcharge**.
- Add "DD" to model number for radius end on both sides, ADD **20% upcharge**.
- Each radius adds 6" overhang per side.

GALLERY CORNER TRANSACTION TOPS

MODEL# DIMENSIONS FREIGHT CLASS WT/LBS. CUBIC FT. LIST PRICE

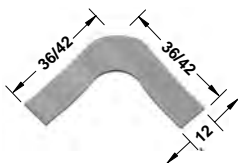

Gallery Corner Transaction Top - 1" thick

DA1GC36	36 x 36 x 1	125	32	5	\$605
DA1GC42	42 x 42 x 1	150	38	6.50	\$605

One piece corner top to be used on 36" and 42" 5-sided corners. Cut-out maximizes use of worksurface space allowing for computer screen. Includes all necessary Flat Plates, Joining Plates and screws. Thickness matches Adaptabilities, Genoa, Halton and Zira Series worksurfaces. Ships 1 set per carton.

- Woodgrain runs in one direction.

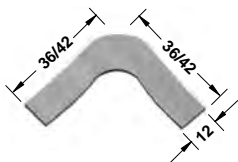

Gallery Corner Transaction Top - 1½" thick

DC1GC36	36 x 36 x 1.5	100	43	5	\$753
DC1GC42	42 x 42 x 1.5	125	50	6.50	\$753

One piece corner top to be used on 36" and 42" 5-sided corners. Cut-out maximizes use of worksurface space allowing for computer screen. Includes all necessary Flat Plates, Joining Plates and screws. Thickness matches Zira worksurfaces. Ships 1 set per carton.

- Woodgrain runs in one direction.

2 PIECE GALLERY CORNER TRANSACTION TOPS

MODEL# DIMENSIONS FREIGHT CLASS WT/LBS. CUBIC FT. LIST PRICE



2 Piece Gallery Corner Transaction Top - 1" thick

DA2GC36	36 x 36 x 1	70	29	1.90	\$429
DA2GC42	42 x 42 x 1	70	33	1.90	\$429

Two piece corner top to be used on 36" and 42" 5-sided corners. Cut-out maximizes use of worksurface space allowing for computer screen. Includes all necessary Flat Plates, Joining Plates and screws. Thickness matches Adaptabilities, Genoa, Halton and Zira Series worksurfaces. Ships 1 set per carton.

- Woodgrain runs in two directions.

Required Specifications

Laminate Finish
Edge Detail

Optional Specifications

Radius End (DCTT models)

2 PIECE GALLERY CORNER TRANSACTION TOPS



**2 Piece Gallery Corner
Transaction Top - 1½" thick**

MODEL#	DIMENSIONS	FREIGHT CLASS	WT/LBS.	CUBIC FT.	LIST PRICE
D x W x H					
DC2GC36	36 x 36 x 1.5	70	39	1.90	\$577
DC2GC42	42 x 42 x 1.5	65	45	1.90	\$577

Two piece corner top to be used on 36" and 42" 5-sided corners. Cut-out maximizes use of worksurface space allowing for computer screen. Includes all necessary Flat Plates, Joining Plates and screws. Thickness matches Zira worksurfaces. Ships 1 set per carton.

- Woodgrain runs in two directions.

2-WAY CONNECTOR TRANSACTION TOPS



**2-Way Connector
Transaction Top - 1" thick**

MODEL#	DIMENSIONS	FREIGHT CLASS	WT/LBS.	CUBIC FT.	LIST PRICE
DATT2W	12 x 12 x 1	70	6	.30	\$271

Used as a corner piece to link two transaction tops. Deduct 6" from each side adjoining the corner piece. Includes all necessary Flat Plates, Joining Plates and screws. Thickness matches Adaptabilities, Genoa, Halton and Zira Series worksurfaces. Ships 1 set per carton.

- Woodgrain runs diagonally.

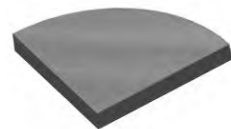

**2-Way Connector
Transaction Top - 1½" thick**

DCTT2W	12 x 12 x 1.5	65	7	.30	\$315
--------	---------------	----	---	-----	--------------

Used as a corner piece to link two transaction tops. Deduct 6" from each side adjoining the corner piece. Includes all necessary Flat Plates, Joining Plates and screws. Thickness matches Zira worksurfaces. Ships 1 set per carton.

- Woodgrain runs diagonally.

4-WAY CONNECTOR TRANSACTION TOPS

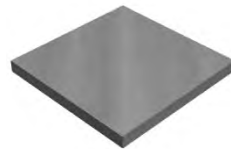

**4-Way Connector
Transaction Top - 1" thick**

DATT4W	12 x 12 x 1	65	8	.30	\$288
--------	-------------	----	---	-----	--------------

Used as a corner piece to link four transaction tops. Deduct 6" from each side adjoining the corner piece. Includes all necessary Flat Plates, Joining Plates and screws. Thickness matches Adaptabilities, Genoa, Halton and Zira Series worksurfaces. Ships 1 set per carton.

- Woodgrain runs diagonally.

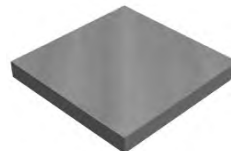

**4-Way Connector
Transaction Top - 1½" thick**

DCTT4W	12 x 12 x 1.5	60	10	.30	\$370
--------	---------------	----	----	-----	--------------

Used as a corner piece to link four transaction tops. Deduct 6" from each side adjoining the corner piece. Includes all necessary Flat Plates, Joining Plates and screws. Thickness matches Zira worksurfaces. Ships 1 set per carton.

- Woodgrain runs diagonally.

Required Specifications

Laminate Finish
Edge Detail

wellness solutions



Wellness Solutions

518

LAMINATE PANELS	MODEL#	DIMENSIONS	FREIGHT CLASS	WT/LBS.	CUBIC FT.	LIST PRICE	HP ADD
		D x W x H	Laminate Finishes (for GCBMSGxxxxLP):				
• Surface mounted wellness guard provides a physical divider			ACJ	Absolute Acajou	HGT	Hayden Grey	
• Acrylic glazing is clear and support rails are painted Designer White (DWT).			ASN	Asian Night	QTM	Quartered Mahogany	
• Kit includes all hardware to install on an existing surface			AWC	Avant Cherry	SOG	Storm Grey	
• Aluminum extruded posts			AWH	Avant Honey	TFW	Tiger Fruitwood	
			BLK	Black	TWL	Tiger Walnut	
			BRC	Brushed Cobalt	WHE	Walnut Heights	
			CMB	Clear Maple	WHC	White Chocolate	
			DES	Dark Espresso	WCR	Winter Cherry	
			DWT	Designer White	WGY	Willow Grey	

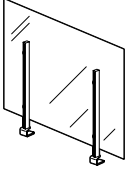
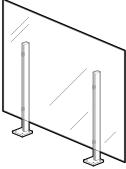
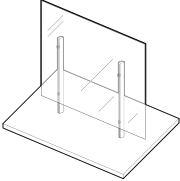
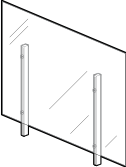
WELLNESS SCREENS	MODEL#	DIMENSIONS	FREIGHT CLASS	WT/LBS.	CUBIC FT.	LIST PRICE	
		D x W x H					
 <p>Wellness Screen - Clamp Mount</p>	GCTCSG3636LP	3 x 36 x 36	300	20.20	2.92	\$447	
	GCTCSG3648LP	3 x 48 x 36	300	22.80	3.98	\$558	
	GCTCSG3636W	3 x 36 x 36	300	20.20	2.92	\$459	
	GCTCSG3648W	3 x 48 x 36	300	22.80	3.98	\$569	
Includes clamp mount brackets, for use with existing worksurface or transaction top. Select model ending in LP for tops up to 1-1/8" thick or W for tops up to 1 1/2" thick							
 <p>Wellness Screen - Surface Mount</p>	GCBMSG3636LP	5 x 36 x 36	300	20.20	2.92	\$447	
	GCBMSG3648LP	5 x 48 x 36	300	22.80	3.98	\$558	
Includes flat face surface mounting brackets, for use with existing worksurface or transaction top.							
 <p>Wellness Screen - Freestanding*</p>	GCBMSG3636LP	12 x 36 x 36	250	28.45	2.92	\$496	
	GCBMSG3648LP	12 x 48 x 36	250	34.17	3.98	\$639	
12"D, board mounted. Available in all standard Global laminate finishes.							
 <p>Wellness Screen - Under Mount</p>	GCAMSG3636LP	2 x 36 x 36	300	20.20	2.92	\$365	
	GCAMSG3648LP	2 x 48 x 36	300	22.80	3.98	\$475	
No mounting hardware included; drilling required. For use with existing worksurface or transaction top.							
Sold individually:							
		GCFSGS1618-1	15 x 18 x 15.75	150	5.15	0.97	\$363
		GCFSGA1923-1	15.75 x 23 x 19	92.5	7.30	0.67	\$417
Sold in packs of 5:							
		GCFSGS1618-5	15 x 18 x 15.75	150	25.75	4.86	\$1737
		GCFSGA1923-5	15.75 x 23 x 19	92.5	36.50	3.37	\$2014
Self-supported tri-fold wellness screens create a physical divider. Lightweight and foldable for easy transport or storage. Acrylic glazing is 3mm with clear finish. Includes support feet and integrated handles.							
<ul style="list-style-type: none"> • Models ending in -1 are a single unit, individually packed • Models ending in -5 are a bundle of 5 units, bulk packed. 							

Required Specifications
Finish*

UNIVERSAL PRIVACY PANELS	MODEL#	DIMENSIONS	FREIGHT CLASS	WT/LBS.	CUBIC FT.	LIST PRICE
--------------------------	--------	------------	---------------	---------	-----------	------------

D x W x H

- Divide space with flexibility.
- Lightweight and easy to clean partitions
- Minimal footprint for storage
- Fluted solid white polypropylene screens are surrounded by a 0.5" x 2.5" powder coated aluminum frame in Designer White (**DWT**) or Tungsten (**TUN**)
- Charcoal soft touch radius end trim
- 7" panel opening at panel bottom for easy cleaning and cable pass-through
- Includes all connecting hardware and 1" leveling glide
- Stations are 60" wide by 42" deep by 66" high.

UNIVERSAL PRIVACY PANELS	MODEL#	DIMENSIONS	FREIGHT CLASS	WT/LBS.	CUBIC FT.	LIST PRICE
--------------------------	--------	------------	---------------	---------	-----------	------------

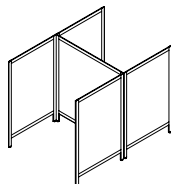

H-Configuration

GCPPH666085	85 x 60 x 66	150	90	18.74	\$1754
-------------	--------------	-----	----	-------	---------------

Pre-configured in a back-to-back "H", with ability to add stations with a "T" configuration. Includes four 42" w panels and one 60" w panel and all connecting hardware. Accepts "T-Configuration" to create longer runs of stations.

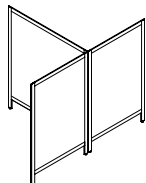

T-Configuration

GCPPT666085	85 x 60 x 66	125	73	11.82	\$1118
-------------	--------------	-----	----	-------	---------------

Includes two 42" w panels and one 60" w panel and all connecting hardware. Connects to "H-Configurations" to create longer runs of stations.

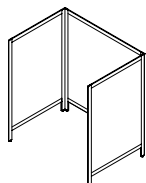

U-Configuration

GCPPU666043	43 x 60 x 66	125	73	11.82	\$1121
-------------	--------------	-----	----	-------	---------------

Pre-configured in a back-to-back "U", with ability to add stations with an "L" configuration. Includes two 42" w panels and one 60" w panel and all connecting hardware. Accepts "L-Configuration" to create longer runs of stations.

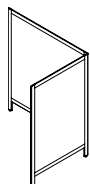

L-Configuration

GCPPL666043	43 x 60 x 66	125	58	8.36	\$799
-------------	--------------	-----	----	------	--------------

Includes two 42" w panels and one 60" w panel and all connecting hardware. Connects to "U-Configurations" to create longer runs of stations.

Required Specifications

Frame finish

LINKING PANELS - SEGMENTED	MODEL#	DIMENSIONS	FREIGHT CLASS	WT./LBS.	CUBIC FT.	LIST PRICE
----------------------------	--------	------------	---------------	----------	-----------	------------

D x W x H

- Segmented panels offer a thermally fused laminate lower and high pressure upper pressed on a lightweight core
- Minimal footprint for storage
- Easy to connect
- Easy to reconfigure
- Easy to clean
- Panels available in Designer White (**DWT**) or Absolute Acajou (**ACJ**) laminates
- Frames available in Designer White (**DWT**) or Tungsten (**TUN**)
- Width options: 36", 42", 48", 60" wide
- 66" high
- 1.3" thick.

LINKING PANELS - SEGMENTED	MODEL#	DIMENSIONS	FREIGHT CLASS	WT./LBS.	CUBIC FT.	LIST PRICE
----------------------------	--------	------------	---------------	----------	-----------	------------

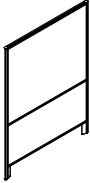

Segmented Linking Panel*

DLSP6636	1.3 x 36 x 66	92.5	35	3	\$623
DLSP6642	1.3 x 42 x 66	92.5	41	3.46	\$641
DLSP6648	1.3 x 48 x 66	92.5	47	3.93	\$654
DLSP6660	1.3 x 60 x 66	85	59	4.90	\$1004

Segmented panels offer a thermally fused laminate lower and high pressure upper pressed on a lightweight core. Minimal footprint for storage. Laminate core available in Designer White (**DWT**) or Absolute Acajou (**ACJ**). Aluminum extrusion comes in powder coated paint finish in Designer White (**DWT**) or Absolute Acajou (**ACJ**). Comes complete with hinge kits and levelers on both legs.

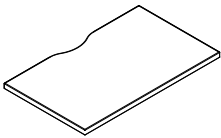

Worksurface, for Segmented Panel**

DLSPWS1830SCPLP	18 x 30 x 1	60	15	.50	\$144
-----------------	-------------	----	----	-----	--------------

Straight rectangular laminate worksurface, non handed, can be interchanged on site, and features a scoop for cable pass-through. Available in Designer White (**DWT**) or Absolute Acajou (**ACJ**). Edging available in Designer White (**DWE**) or Absolute Acajou (**ACJ**).

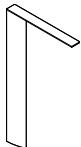

Worksurface Off-Module Cantilever*

DLSPHOMC	12 x 3 x 21	100	4	.42	\$114
----------	-------------	-----	---	-----	--------------

For use with fabric bottom panels. Installs on horizontal rails of panels to provide worksurface support. Frees up space under the worksurface. Powder coated paint finish in Designer White (**DWT**) or Tungsten (**TUN**).

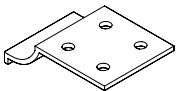

Worksurface Bracket*

DLSPHBRKT	3 x 2.25 x 0.75	70	.10	.05	\$9
-----------	-----------------	----	-----	-----	------------

Extruded aluminum bracket that is bolted to the underside of the worksurface. Bracket supports worksurface at any location along the middle rail of the panel. Includes mounting hardware. Powder coated paint finish in Designer White (**DWT**) or Tungsten (**TUN**).

Required Specifications

- Frame finish*
- Laminate finish**

LINKING PANELS	MODEL#	DIMENSIONS	FREIGHT CLASS	WT./LBS.	CUBIC FT.	LIST PRICE
----------------	--------	------------	---------------	----------	-----------	------------

D x W x H

- Laminate linking panels provide privacy.
- Standard height of 54" or 66", width in 6" increments from 24" to 60".
- Aluminum extrusion comes in powder coated paint finish: Designer White (DWT) or Tungsten (TUN).
- Laminate core offered in Designer White (DWT) or Absolute Acajou (ACJ).
- Edge banded to match laminate finish.
- Panels come complete with hinge kits

Planning Diagrams

- When supported on one side (by 90° turn, supporting "T" legs or wall mounting), panels can run two long OR a maximum of 8'.
- When supported on both sides (by 90° turn, supporting "T" legs or wall mounting), panels can run three long OR a maximum of 13'.

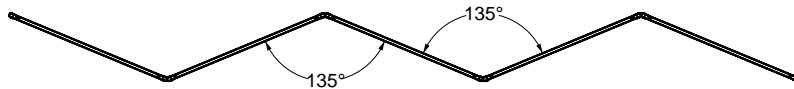
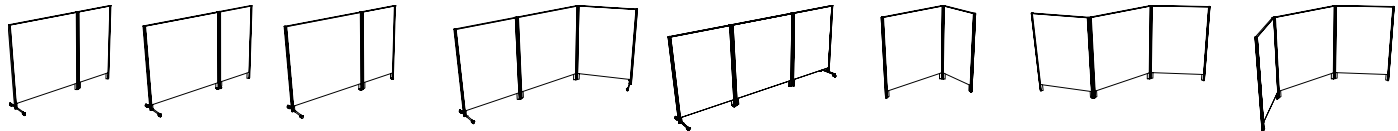

For longer, unsupported runs, panels must maintain a 135° angle (or less) to remain stable.

LAMINATE LINKING PANELS	MODEL#	DIMENSIONS	FREIGHT CLASS	WT./LBS.	CUBIC FT.	LIST PRICE
-------------------------	--------	------------	---------------	----------	-----------	------------

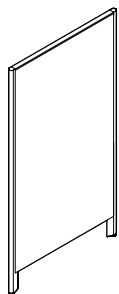

Laminate Panel - Leveler/Leveler

DPL5424	1.3 x 24 x 54	92.5	18	1.62	\$473	
DPL5430	1.3 x 30 x 54	92.5	23	2.08	\$525	
DPL5436	1.3 x 36 x 54	92.5	27	2.47	\$577	
DPL5442	1.3 x 42 x 54	92.5	32	2.85	\$629	
DPL5448	1.3 x 48 x 54	92.5	37	3.25	\$681	
DPL5454	1.3 x 54 x 54	92.5	42	3.63	\$733	
DPL5460	1.3 x 60 x 54	92.5	47	4.02	\$786	
DPL6624	1.3 x 24 x 66	92.5	23	2.04	\$537	
DPL6630	1.3 x 30 x 66	92.5	29	2.52	\$594	
DPL6636	1.3 x 36 x 66	92.5	35	3	\$651	
DPL6642	1.3 x 42 x 66	92.5	41	3.46	\$708	
DPL6648	1.3 x 48 x 66	92.5	47	3.93	\$766	
DPL6654	1.3 x 54 x 66	92.5	53	4.40	\$824	
DPL6660	1.3 x 60 x 66	92.5	59	4.90	\$880	

Levelers on both legs.

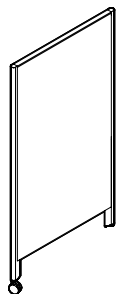

Laminate Panel - Caster/Leveler

DPLSCH5424	1.3 x 24 x 54	92.5	18	1.62	\$567	
DPLSCH5430	1.3 x 30 x 54	92.5	23	2.08	\$622	
DPLSCH5436	1.3 x 36 x 54	92.5	27	2.47	\$676	
DPLSCH5442	1.3 x 42 x 54	92.5	32	2.85	\$731	
DPLSCH5448	1.3 x 48 x 54	92.5	37	3.25	\$786	
DPLSCH5454	1.3 x 54 x 54	92.5	42	3.63	\$840	
DPLSCH5460	1.3 x 60 x 54	92.5	47	4.02	\$894	
DPLSCH6624	1.3 x 24 x 66	92.5	23	2.04	\$631	
DPLSCH6630	1.3 x 30 x 66	92.5	29	2.52	\$691	
DPLSCH6636	1.3 x 36 x 66	92.5	35	3	\$752	
DPLSCH6642	1.3 x 42 x 66	92.5	41	3.46	\$812	
DPLSCH6648	1.3 x 48 x 66	92.5	47	3.93	\$871	
DPLSCH6654	1.3 x 54 x 66	92.5	53	4.40	\$953	
DPLSCH6660	1.3 x 60 x 66	92.5	59	4.90	\$991	

Single locking caster on one leg, leveler on the other.

Required Specifications

Finish

LAMINATE PANELS

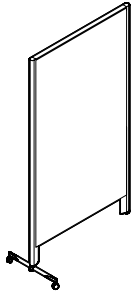

Laminate Panel

MODEL#	DIMENSIONS D x W x H	FREIGHT CLASS	WT/LBS.	CUBIC FT.	LIST PRICE	HP ADD
DPLDCH5424	1.3 x 24 x 54	92.5	18	1.62	\$580	
DPLDCH5430	1.3 x 30 x 54	92.5	23	2.08	\$635	
DPLDCH5436	1.3 x 36 x 54	92.5	27	2.47	\$689	
DPLDCH5442	1.3 x 42 x 54	92.5	32	2.85	\$743	
DPLDCH5448	1.3 x 48 x 54	92.5	37	3.25	\$798	
DPLDCH5454	1.3 x 54 x 54	92.5	42	3.63	\$852	
DPLDCH5460	1.3 x 60 x 54	92.5	47	4.02	\$906	
DPLDCH6624	1.3 x 24 x 66	92.5	23	2.04	\$644	
DPLDCH6630	1.3 x 30 x 66	92.5	29	2.52	\$704	
DPLDCH6636	1.3 x 36 x 66	92.5	35	3	\$764	
DPLDCH6642	1.3 x 42 x 66	92.5	41	3.46	\$824	
DPLDCH6648	1.3 x 48 x 66	92.5	47	3.93	\$883	
DPLDCH6654	1.3 x 54 x 66	92.5	53	4.40	\$943	
DPLDCH6660	1.3 x 60 x 66	92.5	59	4.90	\$1003	

Leveler on one leg and double locking caster base on the other. Freestanding.

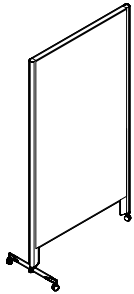

Laminate Panel

DPLDCM5424	1.3 x 24 x 54	92.5	18	1.62	\$616	
DPLDCM5430	1.3 x 30 x 54	92.5	23	2.08	\$672	
DPLDCM5436	1.3 x 36 x 54	92.5	27	2.47	\$726	
DPLDCM5442	1.3 x 42 x 54	92.5	32	2.85	\$780	
DPLDCM5448	1.3 x 48 x 54	92.5	37	3.25	\$834	
DPLDCM5454	1.3 x 54 x 54	92.5	42	3.63	\$889	
DPLDCM5460	1.3 x 60 x 54	92.5	47	4.02	\$943	
DPLDCM6624	1.3 x 24 x 66	92.5	23	2.04	\$681	
DPLDCM6630	1.3 x 30 x 66	92.5	29	2.52	\$741	
DPLDCM6636	1.3 x 36 x 66	92.5	35	3	\$801	
DPLDCM6642	1.3 x 42 x 66	92.5	41	3.46	\$860	
DPLDCM6648	1.3 x 48 x 66	92.5	47	3.93	\$920	
DPLDCM6654	1.3 x 54 x 66	92.5	53	4.40	\$980	
DPLDCM6660	1.3 x 60 x 66	92.5	59	4.90	\$1040	

Single locking caster on one leg and double locking caster base on the other. Freestanding.

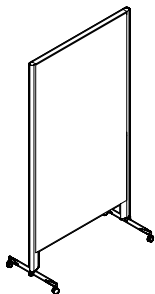



Laminate Panel

DPLM5424	1.3 x 24 x 54	92.5	18	1.62	\$626	
DPLM5430	1.3 x 30 x 54	92.5	23	2.08	\$680	
DPLM5436	1.3 x 36 x 54	92.5	27	2.47	\$735	
DPLM5442	1.3 x 42 x 54	92.5	32	2.85	\$789	
DPLM5448	1.3 x 48 x 54	92.5	37	3.25	\$843	
DPLM5454	1.3 x 54 x 54	92.5	42	3.63	\$897	
DPLM5460	1.3 x 60 x 54	92.5	47	4.02	\$952	
DPLM6624	1.3 x 24 x 66	92.5	23	2.04	\$692	
DPLM6630	1.3 x 30 x 66	92.5	29	2.52	\$752	
DPLM6636	1.3 x 36 x 66	92.5	35	3	\$812	
DPLM6642	1.3 x 42 x 66	92.5	41	3.46	\$871	
DPLM6648	1.3 x 48 x 66	92.5	47	3.93	\$931	
DPLM6654	1.3 x 54 x 66	92.5	53	4.40	\$992	
DPLM6660	1.3 x 60 x 66	92.5	59	4.90	\$1052	

Double locking caster base on both legs. Freestanding.

Required Specifications

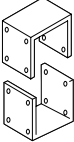
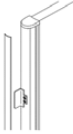
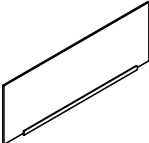
Finish

LINKING PANEL ACCESSORIES	MODEL#	DIMENSIONS	FREIGHT CLASS	WT/LBS.	CUBIC FT.	LIST PRICE
 <p>Wall Connection</p>	D x W x H					
	DPLWA54	2 x 2 x 54	70	2.3	0.13	\$122
	DPLWA66	2 x 2 x 66	65	3.5	0.15	\$139
<p>Connects linking panels to walls. Available in Designer White (DWT) or Tungsten (TUN) paint finish. Kit consists of vertical extrusion, charcoal PVC cover and hinge kits.</p>						
 <p>Expanding Kit</p>	DPLEKIT	2 x 2 x 3	70	1	.05	\$214
	<p>Connects two linking panels in a straight line. This kit will accommodate any special width by overlapping the panels. Available in Designer White (DWT) or Tungsten (TUN) paint finish. Kit consists of a top and bottom bracket and all necessary hardware.</p>					
 <p>Door and Door Catch Kit</p>	DPDC01	1.3 x 3 x 6	60	2	.05	\$133
	<p>Converts any linking panel into a door. Available in Designer White (DWT) or Tungsten (TUN) paint finish. Kit consists of striker plate, two hinge kits, single caster foot assembly and 1" caster.</p>					
 <p>PET Felt Over Panel</p>	DPLOP24	1.05 x 24 x 16.8	70	1.74	.39	\$110
	DPLOP30	1.05 x 30 x 16.8	150	2.20	.49	\$130
	DPLOP36	1.05 x 36 x 16.8	150	2.67	.59	\$153
	DPLOP42	1.05 x 42 x 16.8	150	3.14	.70	\$170
	DPLOP48	1.05 x 48 x 16.8	150	3.60	.80	\$254
	DPLOP54	1.05 x 54 x 16.8	150	4.07	.90	\$274
	DPLOP60	1.05 x 60 x 16.8	150	4.53	1.01	\$297
<p>For laminate panels. Sits atop laminate panel and bridges the gap between the 66"H laminate linking panel and top of the consultation booth. Available in Designer White (DWT) or Tungsten (TUN) paint finish. Kit contains aluminum extrusion and felt insert.</p>						
 <p>Booth to Panel Connector</p>	DEBPA	1.3 x 3 x 66	65	3.5	.15	\$95
	<p>Facilitates the connection of a linking panel to the back gable edge of the consultation booth. Aluminum extrusion available in Designer White (DWT) or Tungsten (TUN) paint finish. Kit includes a vertical extrusion, charcoal PVC cover and all necessary hardware.</p>					

Required Specifications
Finish

CONSULTATION BOOTHS MODEL# DIMENSIONS FREIGHT CLASS WT/LBS. CUBIC FT. LIST PRICE

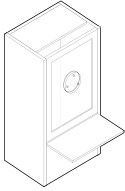

Consultation Booth

	D x W x H					
L2RSB	36 x 36 x 82	250	238.81	61.50	\$2890	

Ideal for hospitals, clinics, reception areas, or anywhere a safe, self-contained environment is required. Consultation booth has a protected speaker hold, a paper space above the worksurface, an interior and exterior worksurface. Gap between the worksurface and glazed frame can be changed during assembly, from 1.5" to 4", based on the direction of the screen. Available in Designer White (**DWT**) only. Can be closed or connected with Linking Laminate Panels. Ships knocked down.

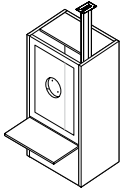

Ceiling Feed Pole*

L2SBCF	1.5 x 4.5 x 75	65	8.69	.29	\$163	
--------	----------------	----	------	-----	--------------	--

Can be used to bring power and/or data from the ceiling to the booth. Aluminum extrusion available in Designer White (**DWT**) or Tungsten (**TUN**) paint finish. Kit includes aluminum extrusions, spacer, trim kit and double-sided adhesive tape.

Required Specifications

Finish

productivity solutions



Productivity Solutions

526



Productivity Solutions™ by Global is a comprehensive series of ergonomically sound products, naturally connecting people with technology to enhance comfort and productivity. Designed to Fit you and your technology and fully integrate with Global Furniture Group products to create complete office solutions that meet the needs of today's diverse workplaces.

Designed with human capabilities and comfort in mind, Productivity Solutions by Global provide a good Fit for today's workers and meet or exceed ergonomics standards, guidelines and ANSI/BIFMA standards for performance, durability and safety.

FIT = Move + Match + Support

Features and Benefits

- Foli Height Adjustable Table with 18.4" height range
- Manual Height Adjustable Table has counterbalanced spring mechanism
- 4 keyboard support mechanisms
- 5 keyboard trays
- New monitor arm options
- Wire management and power/data options
- Meets ANSI-BIFMA, Greenguard Indoor Air Quality, Greenguard Gold Certified
- Height Adjustable Tables are BIFMA level 2 certified



Monitor Arms



Power/Data Module



Lift n Lock Keyboard Tray



Foli Electric Height Adjustable Table



Manual Height Adjustable Desk

MANUAL HEIGHT ADJUSTABLE TABLES

- Manually operated height adjustable tables with counterbalanced spring mechanism
 - Exceptional ergonomic alternative to traditional desking
 - Sit-Stand design promotes increased circulation, improving performance and comfort
 - Can be used alone or in conjunction with Global desks.
- Please note:** Global desks are 1" or 1.5" thick.
- Meets ANSI/BIFMA requirements

TOP FINISHES

ACJ	Absolute Acajou	HGT	Hayden Grey
ASN	Asian Night	QTM	Quartered Mahogany
AWC	Avant Cherry	SOG	Storm Grey
AWH	Avant Honey	TFW	Tiger Fruitwood
BLK	Black	TWL	Tiger Walnut
BRC	Brushed Cobalt	WHE	Walnut Heights
CMB	Clear Maple	WHC	White Chocolate
DES	Dark Espresso	WCR	Winter Cherry
DWT	Designer White	WGY	Willow Grey

CONSTRUCTION

- 1" thick tops constructed of 45 lb. density particle board with high performance thermally fused laminate

DIMENSIONS

- When designing workstations, leave 1" clearance on either side to prevent finger pinch

EDGE

- Preferred matching edge

BASE

- Heavy duty steel formed legs with radius detail are available in BLACK only
- Easy to reach tension control supports loads up to 100 lbs.
- Environmentally friendly, recyclable epoxy powder coating provides a very durable finish
- Black plastic leveling glides offer 1/2" adjustability

GROMMETS

- Grommets available in standard worksurface locations (left, center or right)
- Order as: **AG1, AG2 or AG3. ADD \$69.**



- Grommet hole dimensions are 3 1/4" wide x 1 7/8" deep

MECHANISM

- Counterbalanced height adjustable base supports weights up to 100 lbs.
- Height range from floor to underside of modesty shroud is 17" when surface height is 26"
- 7 year warranty

SHIPPING

- Shipped RTA (Ready to Assemble)
- Easy to assemble with Phillips or Robertson screwdriver

MODEL#	DIMENSIONS	FREIGHT CLASS	WT./LBS.	CUBIC FT.	LIST PRICE
D x W x H					
Rectangular Tops:					
HTM3058T	30 x 58 x 1	70	50	2.50	\$404
HTM3046T	30 x 46 x 1	70	40	2	\$337
HTM2458T	24 x 58 x 1	70	40	2	\$309
HTM2446T	24 x 46 x 1	70	32	1.50	\$287
Base:					
KEZLIFT	24 x 34.5 x 26-46	70	88	5.40	\$2178

Paddle activated height adjustable base. Height adjustable from 26" to 46". Keyboard tray and mechanism not necessary

- **Specify base separately from top**

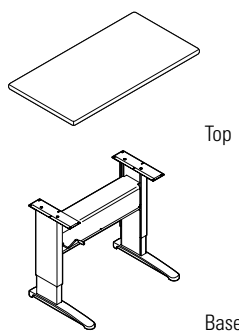

Rectangular Table

Required Specifications

Top Finish

FOLI ELECTRIC HEIGHT ADJUSTABLE TABLES

D x W x H

- Electric height adjustment allows for easy movement from sitting to standing and back throughout the day. Foli's work surface moves with you and your work without interruption.
- Foli offers a universal free-standing design and finish options to easily integrate with existing Global workstation configurations, becoming a natural part of your office space
- Whether in a private or general office, touch-down space, collaborative area or home office, Foli supports a more active and healthy work style
- Can be used alone or in conjunction with Global desks. Please note Global desks are 1" or 1.5" thick.

TOP FINISHES

ACJ	Absolute Acajou	HGT	Hayden Grey
ASN	Asian Night	QTM	Quartered Mahogany
AWC	Avant Cherry	SOG	Storm Grey
AWH	Avant Honey	TFW	Tiger Fruitwood
BLK	Black	TWL	Tiger Walnut
BRC	Brushed Cobalt	WHE	Walnut Heights
CMB	Clear Maple	WHC	White Chocolate
DES	Dark Espresso	WCR	Winter Cherry
DWT	Designer White	WGY	Willow Grey

EDGE

- Preferred matching edge

CONSTRUCTION

- Tops are 1" thick, constructed of 45 lb. density particle board covered on both sides with high performance thermally fused laminate. Optional high pressure laminate tops are 1-1/16" thick.
- Steel constructed leg tubing, feet and cross bar
- Table frame designed with 3.15" x 2.35" rectangular outer leg with large tubing facing down
- "T" leg, flat foot design with adjustable glides
- Expandable cross bars for table widths of 48", 54", 60", 66" and 72"
- Available table depths of 24" and 30"
- Products specified with the high pressure laminate option are finished on the underside of the surface with a kraft paper backing.

BASE

- Provides height adjustment from 22.6" to 48.6" (26" adjustability with 1" top)
- Leveling glides offer 1" adjustability
- Operates at 1.3" per second
- Lifts 220 lbs.
- Shadow power draw 0.5 watts
- Base available in a Silver powder coated finish, will never mar during adjustment
- Open front cross bar to accommodate articulating keyboard platforms.
- Easy to use, push button controller with digital readout.
- Dual motors are concealed within column.

SHIPPING

- Shipped unassembled in 1 carton
- Easy to assemble.

GROMMETS

- Grommets available in standard table top locations (left, center or right). Order as: **AG1, AG2 or AG3 - Add \$69**
- Grommet hole dimensions are 3 1/4" wide x 1 7/8" deep.
- Grommets may be placed at non-standard locations. Order as: **AGS - Add \$69**. A drawing must be supplied with vertical and horizontal dimensions to the center of the cut-out (as in drawing below). Please refer to CUSTOM GROMMET LOCATION FORM in the back reference section.

Grommet hole dimensions:

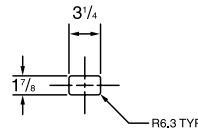

Grommet:

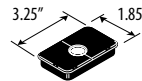

Grommet Locations:

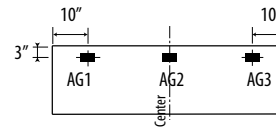

POWER BLOCK

- A power block (model **PMSPDM**) may be installed on all Foli tables
- The power block module includes one electrical duplex receptacle and two data (RJ45) receptacles. 9' Black cord with NEMA plug. Power block dimensions are 6.5"W x 3.5"D x 2.75"H.
- Power block cutout dimensions are 2.75"D x 6"W.
- Specify the power block cut-out location when ordering the table. The power block is ordered separately. Order power block separately as **PMSPDM, ADD \$261**. Power blocks are available in standard worksurface locations (left, center or right). Specify **E1, E2 or E3 cutout location. Add \$69.**

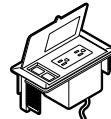

Power Block **PMSPDM. Add \$261**

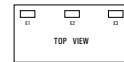

Specify location **E1, E2 or E3. Add \$69**

FOLI ELECTRIC HEIGHT ADJUSTABLE TABLES

MODEL# DIMENSIONS FREIGHT CLASS WT/LBS. CUBIC FT. LIST PRICE HP ADD

D x W x H

Rectangular Tops:

PHAT2970T	29 x 70 x 1	65	70	2.50	\$429	\$215
PHAT2964T	29 x 64 x 1	65	64	2.26	\$408	\$204
PHAT2958T	29 x 58 x 1	65	59	2.10	\$391	\$196
PHAT2952T	29 x 52 x 1	65	52	1.90	\$383	\$192
PHAT2946T	29 x 46 x 1	65	44	1.70	\$374	\$187
PHAT2370T	23 x 70 x 1	65	57	2	\$425	\$213
PHAT2364T	23 x 64 x 1	65	52	1.82	\$393	\$197
PHAT2358T	23 x 58 x 1	65	47	1.67	\$375	\$188
PHAT2352T	23 x 52 x 1	65	42	1.52	\$336	\$168
PHAT2346T	23 x 46 x 1	65	35	1.40	\$314	\$157

Base:

PH3T6601	10 x -- x 26.8	70	59.5	2.83	\$973	n/a
----------	----------------	----	------	------	--------------	-----



Top

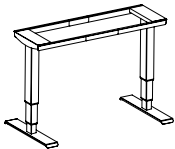

Base

Foli Rectangular Table

All table frames are easy to assemble with few parts. Lifts 220 lbs. Base manufactured so that leg paint will never mar during height adjustment. Leg assembly tubing, feet and upper structure assemblies constructed of steel. Table frame designed with 3.15" x 2.36" rectangular outer leg with the large tube facing down. Flat foot design with adjustable glides. I-profile crossbars that are expandable in fixed steps to create a variety of size table widths. Height range is 22.6" to 48.6" (26" adjustability with 1" top). Operates at 1.3" per second. Shadow power draw is 0.5 watts. Maximum power draw is 1.5A. Base finish in Silver powder coat only.

- **Specify base separately from top**
- **Recommended torque range for installing all fasteners is 3-5 foot pounds and should not be exceeded. In addition, no impact drivers or high-torque equipment are to be used for any fasteners included in the table assembly kits, as this creates a high risk for damage that is not covered under warranty. The use of hand tools is highly recommended.**

Return Tops:

PHAR2947T	29 x 47 x 1	60	104	2.30	\$374	\$187
PHAR2941T	29 x 41 x 1	65	40	1.70	\$370	\$185
PHAR2935T	29 x 35 x 1	65	34	1.50	\$370	\$185
PHAR2347T	23 x 47 x 1	60	94.5	2.10	\$314	\$157
PHAR2341T	23 x 41 x 1	65	40	1.60	\$299	\$150
PHAR2335T	23 x 35 x 1	65	34	1.40	\$271	\$136

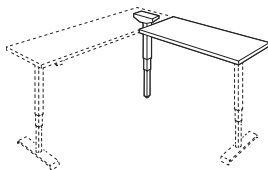

Return Kit

Third Leg Kit:

PH3TLK6601	10 x -- x 26.8	85	19	1.30	\$667	n/a
------------	----------------	----	----	------	--------------	-----

Third leg kit to be used with a Foli freestanding table to create an electric height adjustable L station. Post leg with return kit replaces one of the T-legs on freestanding table; the T-leg from the freestanding table is then moved to support one side of the return top. Cross bar is included to connect and support the return top to the freestanding table top. May be configured for left or right hand returns. All three legs plug into the freestanding table's controller and the three motors will electronically synchronize. The overall footprint with a return kit is not to exceed 72"W x 72"D. The 48"W return kit is only to be used with a 24"D primary table. 36" and 42"W return kits may be used with either 24"D or 30"D primary tables.

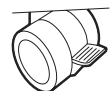

1.5" Dual Wheel Casters

P79100014	- x - x 1.5	60	2	0.4	\$58	N/A
-----------	-------------	----	---	-----	-------------	-----

Pack of four casters, two locking and two non-locking. Interchangeable on site with levelers on Foli electric height adjustable table PHATxxxx models only.

- **Cannot be used with Third Leg Kit**

Required Specifications

Top Finish

Optional Specifications

High Pressure Laminate
Grommet

P PRODUCTIVITY SOLUTIONS™ BY GLOBAL

PET FELT PANELS

- 9mm thick panels offered in 9 finishes
- Made from 100% PET (polyester) fiber with a high content (50%) of post-recycled material, free of added chemicals, binders and adhesives
- Lightweight panels are tackable, impact and tear resistant, bacteria resistant, moisture resistant, and installation friendly
- Variation in fiber mix and color are inherent to the character of the product
- Clamps are included. Available in satin anodized finish only.
- Privacy screen clamps for use on 1" surfaces only.

FELT COLORS

BLK	Black	MTS	Mist
BRI	Brick	PWT	Pewter
DEN	Denim	SHR	Shamrock
GPH	Graphite	WHT	White
HVT	Harvest		

PET FELT PRIVACY SCREENS

MODEL#	DIMENSIONS D x W x H	FREIGHT CLASS	WT/LBS.	CUBIC FT.	LIST PRICE
PT9PP3013-1	.36 x 30 x 12.5	250	2.12	.57	\$131
PT9PP3613-1	.36 x 36 x 12.5	250	2.38	.69	\$139
PT9PP4213-1	.36 x 42 x 12.5	250	2.63	.80	\$186
PT9PP4813-1	.36 x 48 x 12.5	250	3.31	.91	\$194
PT9PP5413-1	.36 x 54 x 12.5	250	3.57	1.03	\$243
PT9PP6013-1	.36 x 60 x 12.5	250	3.82	1.14	\$250
PT9PP6613-1	.36 x 66 x 12.5	250	4.50	1.25	\$298
PT9PP7213-1	.36 x 72 x 12.5	250	4.76	1.36	\$305
PT9PP7813-1	.36 x 78 x 12.5	250	5.01	1.48	\$312

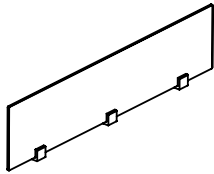

PET Felt Privacy Screen - 1 pk.

PET Felt Privacy Screen available in 9 finishes, please specify. 2, 3 or 4 clamps are included depending on screen size. Clamps available in satin anodized finish only. Privacy screen clamps for use on 1" surfaces only.

- Up to 42" w - 2 clamps per panel
- 48"-60" w - 3 clamps per panel
- 66"-78" w - 4 clamps per panel

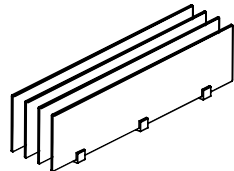

PET Felt Privacy Screen - 4 pk.

PT9PP3013-4	0.36 x 30 x 12.5	85	7.64	.60	\$501
PT9PP3613-4	0.36 x 36 x 12.5	85	8.56	.71	\$530
PT9PP4213-4	0.36 x 42 x 12.5	92.5	9.48	.83	\$716
PT9PP4813-4	0.36 x 48 x 12.5	85	11.90	.98	\$744
PT9PP5413-4	0.36 x 54 x 12.5	92.5	12.80	1.09	\$932
PT9PP6013-4	0.36 x 60 x 12.5	92.5	13.80	1.20	\$957
PT9PP6613-4	0.36 x 66 x 12.5	85	16.20	1.32	\$1143
PT9PP7213-4	0.36 x 72 x 12.5	92.5	17.10	1.43	\$1169
PT9PP7813-4	0.36 x 78 x 12.5	92.5	18	1.54	\$1193

PET Felt Privacy Screen available in 9 finishes, please specify. 2, 3 or 4 clamps are included depending on screen size. Clamps available in satin anodized finish only. Privacy screen clamps for use on 1" surfaces only.

- Up to 42" w - 2 clamps per panel
- 48"-60" w - 3 clamps per panel
- 66"-78" w - 4 clamps per panel

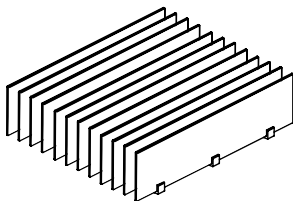

PET Felt Privacy Screen - 12 pk.

PT9PP3013-12	0.36 x 30 x 12.5	92.5	21.60	1.92	\$1472
PT9PP3613-12	0.36 x 36 x 12.5	92.5	24.30	2.26	\$1551
PT9PP4213-12	0.36 x 42 x 12.5	60	26.90	.80	\$2103
PT9PP4813-12	0.36 x 48 x 12.5	92.5	33.80	3.05	\$2180
PT9PP5413-12	0.36 x 54 x 12.5	92.5	36.40	3.39	\$2741
PT9PP6013-12	0.36 x 60 x 12.5	92.5	39	3.72	\$2809
PT9PP6613-12	0.36 x 66 x 12.5	92.5	45.90	4.18	\$3361
PT9PP7213-12	0.36 x 72 x 12.5	92.5	48.50	4.51	\$3430
PT9PP7813-12	0.36 x 78 x 12.5	92.5	51.10	4.85	\$3498

PET Felt Privacy Screen available in 9 finishes, please specify. 2, 3 or 4 clamps are included depending on screen size. Clamps available in satin anodized finish only. Privacy screen clamps for use on 1" surfaces only.

- Up to 42" w - 2 clamps per panel
- 48"-60" w - 3 clamps per panel
- 66"-78" w - 4 clamps per panel

Required Specifications

Finish

PET FELT MODESTY PANELS

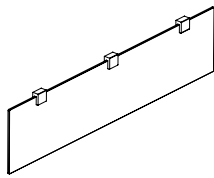

PET Felt Modesty Panel - 1 pk.

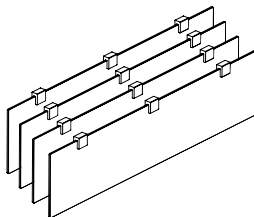

PET Felt Modesty Panel - 4 pk.

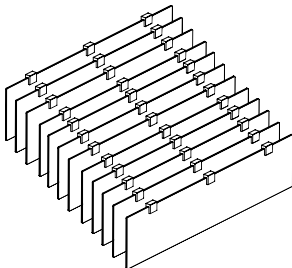

PET Felt Modesty Panel - 12 pk.

MODEL#	DIMENSIONS	FREIGHT CLASS	WT./LBS.	CUBIC FT.	LIST PRICE
PT9MP3013-1	.36 x 30 x 12.5	250	2.12	.57	\$115
PT9MP3613-1	.36 x 36 x 12.5	250	2.38	.69	\$123
PT9MP4213-1	.36 x 42 x 12.5	250	2.63	.80	\$162
PT9MP4813-1	.36 x 48 x 12.5	250	3.31	.91	\$170
PT9MP5413-1	.36 x 54 x 12.5	250	3.57	1.03	\$219
PT9MP6013-1	.36 x 60 x 12.5	250	3.82	1.14	\$226
PT9MP6613-1	.36 x 66 x 12.5	250	4.50	1.25	\$265
PT9MP7213-1	.36 x 72 x 12.5	250	4.76	1.36	\$273
PT9MP7813-1	.36 x 78 x 12.5	250	5.01	1.48	\$280

PET Felt Modesty Panel available in 9 finishes, please specify. 2, 3 or 4 clamps are included depending on screen size. Clamps available in satin anodized finish only. **Specify a nominal size 6" shorter than worksurface size.**

- Up to 42" w - 2 clamps per panel
- 48"-60" w - 3 clamps per panel
- 66"-78" w - 4 clamps per panel

PT9MP3013-4	0.36 x 30 x 12.5	85	7.64	.60	\$437
PT9MP3613-4	0.36 x 36 x 12.5	85	8.56	.71	\$465
PT9MP4213-4	0.36 x 42 x 12.5	92.5	9.48	.83	\$619
PT9MP4813-4	0.36 x 48 x 12.5	85	11.90	.98	\$647
PT9MP5413-4	0.36 x 54 x 12.5	92.5	12.80	1.09	\$836
PT9MP6013-4	0.36 x 60 x 12.5	92.5	13.80	1.20	\$861
PT9MP6613-4	0.36 x 66 x 12.5	85	16.20	1.32	\$1014
PT9MP7213-4	0.36 x 72 x 12.5	92.5	17.10	1.43	\$1040
PT9MP7813-4	0.36 x 78 x 12.5	92.5	18	1.54	\$1064

PET Felt Modesty Panel available in 9 finishes, please specify. 2, 3 or 4 clamps are included depending on screen size. Clamps available in satin anodized finish only. **Specify a nominal size 6" shorter than worksurface size.**

- Up to 42" w - 2 clamps per panel
- 48"-60" w - 3 clamps per panel
- 66"-78" w - 4 clamps per panel

PT9MP3013-12	0.36 x 30 x 12.5	92.5	21.60	1.92	\$1278
PT9MP3613-12	0.36 x 36 x 12.5	92.5	24.30	2.26	\$1358
PT9MP4213-12	0.36 x 42 x 12.5	92.5	26.90	2.60	\$1813
PT9MP4813-12	0.36 x 48 x 12.5	92.5	33.80	3.05	\$1890
PT9MP5413-12	0.36 x 54 x 12.5	92.5	36.40	3.39	\$2451
PT9MP6013-12	0.36 x 60 x 12.5	92.5	39	3.72	\$2519
PT9MP6613-12	0.36 x 66 x 12.5	92.5	45.90	4.18	\$2974
PT9MP7213-12	0.36 x 72 x 12.5	92.5	48.50	4.51	\$3043
PT9MP7813-12	0.36 x 78 x 12.5	92.5	51.10	4.85	\$3111

PET Felt Modesty Panel available in 9 finishes, please specify. 2, 3 or 4 clamps are included depending on screen size. Clamps available in satin anodized finish only. **Specify a nominal size 6" shorter than worksurface size.**

- Up to 42" w - 2 clamps per panel
- 48"-60" w - 3 clamps per panel
- 66"-78" w - 4 clamps per panel

Required Specifications

Finish

MONITOR ARMS	MODEL#	DIMENSIONS D x W x H	FREIGHT CLASS	WT./LBS.	CUBIC FT.	LIST PRICE
--------------	--------	-------------------------	---------------	----------	-----------	------------

- Free up valuable space on surfaces
- Attach to any standard surface with flush edge by a desk clamp or through a grommet. Grommets above support panels cannot be used for mounting. Mounting hardware included.
- Clamps on worksurfaces 1/2" to 2 5/8" thick
- 9" vertical height adjustment on 12" post
- For use in grommets up to 3.5" wide
- Built-in cable management
- Quick connect option is standard with hole patterns to meet Video Electronics Standards Association (VESA) standards (75mm x 75mm or 100mm x 100mm)
- Monitor arm components are 100% recycled aluminum die cast material, providing stability and durability
- Available finishes: Silver (**SIL**) standard; Black (**BLK**) and White (**WTE**)

MONITOR ARMS	MODEL#	DIMENSIONS	FREIGHT CLASS	WT./LBS.	CUBIC FT.	LIST PRICE
--------------	--------	------------	---------------	----------	-----------	------------

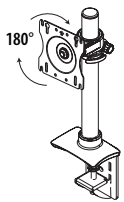

Single Screen Pole Position

MON1SPP	-- x -- x --	150	5.80	1.20	\$253
---------	--------------	-----	------	------	--------------

No extension arms. Minor assembly required. Supports 20 lb. load capacity. No maximum monitor width.

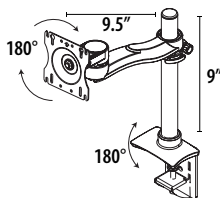

Single Screen Single Extension Arm

MON1SSE	-- x -- x --	150	6.20	1.20	\$341
---------	--------------	-----	------	------	--------------

9.5" horizontal reach from center of pole to front of monitor mounting plate. Displays are able to tilt 180°, swing 180° side-to-side and rotate from landscape to portrait. Minor assembly required. Supports 20 lb. load capacity. No maximum monitor width.

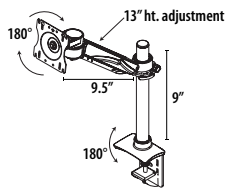

Single Screen Single Extension Arm with Height Adjustment

MON1SSEH	-- x -- x --	125	7.20	1.10	\$437
----------	--------------	-----	------	------	--------------

Counterbalanced arm provides an additional 13" of height adjustment. Easy to use Allen wrench allows user to adjust the counterbalance mechanism for easy movement of the monitor. 9.5" horizontal reach from center of pole to front of monitor mounting plate. Displays are able to tilt 180°, swing 180° side-to-side and rotate from landscape to portrait. Minor assembly required. Supports 20 lb. load capacity. No maximum monitor width.

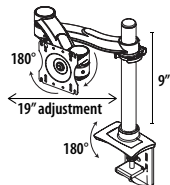

Single Screen Double Extension Arm

MON1SDE	-- x -- x --	125	7.50	1.20	\$427
---------	--------------	-----	------	------	--------------

Double extension allows 19" of horizontal back and forth movement. Arm folds back to post for more desk space. Displays are able to tilt 180°, swing 180° side-to-side and rotate from landscape to portrait. Minor assembly required. Supports 20 lb. load capacity. No maximum monitor width.

Required Specifications
Finish*

MONITOR ARMS

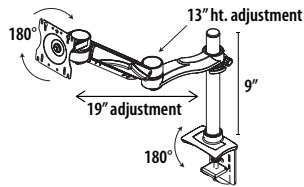

Single Screen Double Extension Arm with Height Adjustment

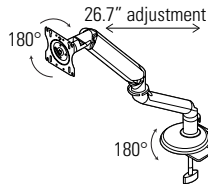

Single Screen Double Extension Arm - Light Duty

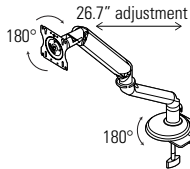

Single Screen Double Extension Arm - Medium Duty

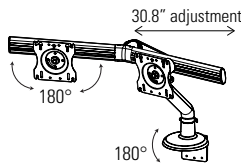

Dual Screen Double Extension Arm

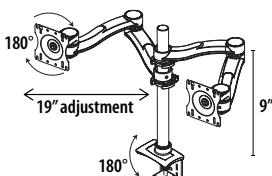

Dual Screen Double Extension Arm

MODEL# DIMENSIONS FREIGHT CLASS WT./LBS. CUBIC FT. LIST PRICE

MODEL#	D x W x H			FREIGHT CLASS	WT./LBS.	CUBIC FT.	LIST PRICE
MON1SDEH	29.3	x 9.5	x 12.5	125	8.20	1.10	\$514

Counterbalanced arm provides an additional 12.4" of height adjustment. Double extension allows 19" of horizontal back and forth movement. Easy to use Allen wrench allows user to adjust the counterbalance mechanism for easy movement of the monitor. Displays are able to tilt 180°, swing 180° side-to-side and rotate from landscape to portrait. Cable manager comes on extension arm and hides all cables. Minor assembly required. Supports 20 lb. load capacity. No maximum monitor width.

M7750LD	5.5	x --	x --	100	10.34	1.12	\$587
---------	-----	------	------	-----	-------	------	--------------

For use with monitors weighing 5 to 20 lbs. Adjustable counterbalance provides free floating fingertip control. Maximum of 26.7" extension from rear of desk to back of monitor; folds to 4.5". Monitor can rotate 180° for portrait or landscape viewing with -90° to 45° tilt adjustment. Integral monitor weight adjustment gauge. Aluminum die cast construction. VESA plate edge clamp and grommet mount included. Silver finish. Some assembly required. Supports 20 lb. load capacity. No maximum monitor width.

• Also available in **Black finish** #M7750LDB or **White finish** #M7750LDW.

M7755MD	5.5	x --	x --	100	10.34	1.12	\$626
---------	-----	------	------	-----	-------	------	--------------

For use with monitors weighing 10 to 30 lbs. Adjustable counterbalance provides free floating fingertip control. Maximum of 26.7" extension from rear of desk to back of monitor; folds to 4.5". Monitor can rotate 180° for portrait or landscape viewing with -90° to 45° tilt adjustment. Integral monitor weight adjustment gauge. Aluminum die cast construction. VESA plate edge clamp and grommet mount included. Silver finish. Some assembly required. Supports 20 lb. load capacity. No maximum monitor width. • Also available in **Black finish** #M7755MDB or **White finish** #M7755MDW.

M7760DSS	26	x 8.4	-30.75 x 24.4	92.5	14.75	1.3	\$812
----------	----	-------	---------------	------	-------	-----	--------------

For use with monitors weighing 6 to 28 lbs. total and maximum width of 24" diagonal. Adjustable counterbalance provides free floating fingertip control. Maximum of 30.8" extension from rear of desk to back of monitor; folds to 8.4". Monitor can rotate 180° for portrait or landscape viewing with -90° to 45° tilt adjustment. Integral monitor weight adjustment gauge. Aluminum die cast construction. VESA plate edge clamp and grommet mount included. Silver finish. Some assembly required. Supports 20 lb. load capacity. No maximum monitor width.

• Also available in **Black finish** #M7760DSB or **White finish** #M7760DSW.

MON2SDE	--	x --	x 12.5	100	10.70	1.20	\$755
---------	----	------	--------	-----	-------	------	--------------

For dual monitor applications. 32" maximum monitor width. Supports a 20lb. load capacity per screen. Double extension arms reach out up to 19". Top of mounting pole is 12.5" from worksurface. Easy to use Allen wrench allows user to adjust the counterbalance mechanism for easy movement of the monitor. Displays are able to tilt 180°, swing 180° side-to-side and rotate from landscape to portrait. Minor assembly required.

Required Specifications

Finish

MONITOR ARMS

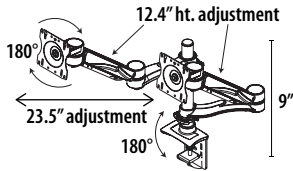

Dual Screen Double Extension Arm with Height Adjustment

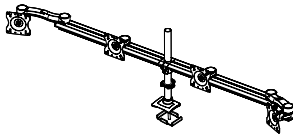

Parabolic Quad Screen Beam Mount*

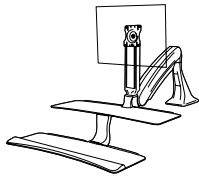

Single Screen Sit-Stand Workstation with Keyboard Tray and Shelf

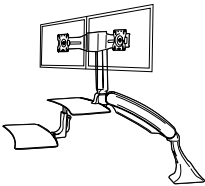

Dual Screen Sit-Stand Workstation with Keyboard Tray and Shelf

MODEL#	DIMENSIONS D x W x H	FREIGHT CLASS	WT./LBS.	CUBIC FT.	LIST PRICE
MON2SDEH	-- x -- x 12.5	150	6	1.20	\$936

For dual monitor applications. 35" maximum monitor width. Supports a 20 lb. load capacity per screen. Counterbalanced arms provide an additional 12.4" of height adjustment. Double extension arms reach out up to 23.5". Easy to use Allen wrench allows user to adjust the counterbalance mechanism for easy movement of the monitor. Displays are able to tilt 180°, swing 180° side-to-side and rotate from landscape to portrait. Cable manager comes on extension arm and hides all cables. Minor assembly required. Supports 20 lb. load capacity.

MONQSBM	-- x -- x --	65	18.30	.70	\$1225
---------	--------------	----	-------	-----	---------------

Supports four monitors. Two outside single extension arms tilt 180° and swing 180° side-to-side. All displays can be rotated from landscape to portrait. Beam is 63.9"w. Minor assembly required. Supports 20 lb. load capacity. 21" maximum monitor width. Bracket for grommet mount only included.

M6011WS	28 x -- x --	125	36	4.8	\$2491
---------	--------------	-----	----	-----	---------------

Desktop edge (rear, side or corner) or grommet mount on 24" or 30" deep worksurfaces. Transition between seated and standing positions, HFES compliant. Over 22" of gas assisted height adjustment plus independent height adjustable mechanism for the keyboard tray. Additional 9.5" of independent counterbalance height adjustment for the monitor. 45° of tilt and 90° of portrait to landscape rotation. Monitor weight limit from 5 to 25 lbs. Silver/Grey (SG) finish. Assembly required.

- Also available in **Black/Black (B/B) finish** #M6011WSBB or **White/Grey (WG) finish** #M6011WSWG.

M6021WS	28 x -- x --	100	42	4.8	\$2759
---------	--------------	-----	----	-----	---------------

Desktop edge (rear, side or corner) or grommet mount on 24" or 30" deep worksurfaces. Transition between seated and standing positions, HFES compliant. Over 22" of gas assisted height adjustment plus independent height adjustable mechanism for the keyboard tray. Additional 9.5" of independent counterbalance height adjustment for the monitor. 45° of tilt and 90° of portrait to landscape rotation. Accommodates most 24" monitors weighing up to 8 lbs. each and offers independent screen adjustments. Silver/Grey (SG) finish. Assembly required.

- Also available in **Black/Black (B/B) finish** #M6021WSBB or **White/Grey (WG) finish** #M6021WSWG.

Required Specifications
Finish

KEYBOARD TRAYS

MODEL# DIMENSIONS FREIGHT CLASS WT/LBS. CUBIC FT. LIST PRICE

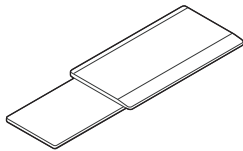

Tray with Sliding Mouse Support

	D x W x H				
KT01	10.5 x 21.3 x 2	70	7	.40	\$207

Mouse surface slides below support for left or right mouse positioning. Keyboard surface is 21" w x 11" d. Mouse surface extends 9" beyond the side of the tray. Compatible with all Global keyboard mechanisms. ABS plastic tray and sliding mouse tray.

- Specify mechanism separately (see next page)

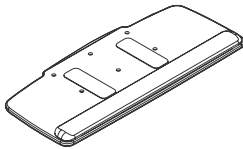

27" HDPE Tray

KT27M02	11.5 x 27.5 x 1	70	6	.40	\$267
---------	-----------------	----	---	-----	-------

Allows mouse to be easily positioned at the same height as, and to the left or right of, the keyboard. Palm rest is easily removable. Includes Mouse Fence with Cable Manager to secure the mouse when the tray is tilted. Includes anti-slip strips. High Density Polyethylene (HDPE) surface material. Plug-in gel-feel foam palm rest. Compatible with all Global keyboard mechanisms.

- Specify mechanism separately (see next page)

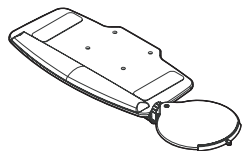

Tray with Height Adjustable Mouse Support - Black

KTMT03	11.5 x 23 x 2.8	100	5.80	.60	\$288
--------	-----------------	-----	------	-----	-------

Low profile tray with highly adjustable Mouse Support that allows the user to position the mouse surface according to their needs and preferences. Mouse support features include: height adjustment, swivel and tilt. User can easily mount on left or right side of keyboard tray, easily swivel and adjust the height position to maintain neutral postures, and independently adjust the mouse surface tilt so mouse stays on the support when the keyboard tray is tilted. Compatible with all Global keyboard mechanisms. Palm rest is easily removable. Includes Mouse Fence with Cable Manager and anti-slip strips. Keyboard tray is 20.5" w x 11" d and mouse support is 11" in diameter. Tray support material is a compact phenolic panel; mouse tray in ABS plastic. Plug-in gel-feel foam palm rest.

- Specify mechanism separately (see next page)

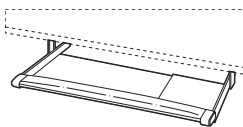

Retractable Keyboard

PKBT-27	17.5 x 28.75 x 4.75	65	10.50	.40	\$252
PKBT-27A	17.5 x 28.75 x 4.75	125	11	1.45	\$255

PKBT-27 - Retractable Keyboard. PKBT-27A - Retractable Keyboard - Assembled. High density polyethylene (HDPE) surface material. Firm feel palm rest.

Required Specifications

Finish*

KEYBOARD MECHANISMS

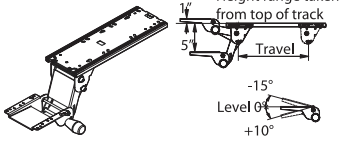

Soft Touch Keyboard Support Mechanism

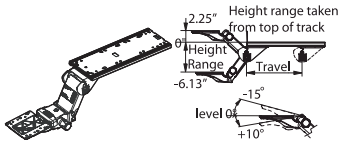

Lift-N-Lock Keyboard Support Mechanism

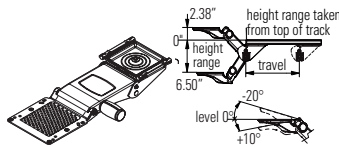

Slim Fit Keyboard Support Mechanism

MODEL#	DIMENSIONS D x W x H	FREIGHT CLASS	WT./LBS.	CUBIC FT.	LIST PRICE
KSM01-21	23.8 x 9 x 4.3	85	9.20	.70	\$205
KSM01-18	19.7 x 7.4 x 3.6	85	7.60	.60	\$205
KSM01-12	13 x 5 x 2.4	85	5.10	.40	\$205

Soft Touch Knob for simultaneous height and tilt adjustment. Spring-assist mechanism. Optional positive tilt lockout available. Add "-L" to end of model number. Compatible with all Global keyboard mechanisms. Good for single users who do not adjust their keyboard often.

- KSM01-21 requires 21.75" of depth clearance under the surface for installation.
- KSM01-18 requires 18" of depth clearance under the surface for installation.
- KSM01-12 requires 12" of depth clearance under the surface for installation.
- **Specify keyboard tray separately (see previous page)**

KSM02-21	23.8 x 9 x 9.7	85	9.70	.70	\$270
KSM02-18	19.7 x 7.4 x 8.2	85	8	.60	\$270
KSM02-12	13 x 5 x 5.4	85	5.40	.40	\$270

Knobless height adjustment and independent tilt adjustment. Locks automatically into position with release of tray. Positive tilt lockout available. Compatible with all Global keyboard mechanisms. Good for single users who frequently change positions and for multiple users.

- KSM02-21 requires 21.75" of depth clearance under the surface for installation.
- KSM02-18 requires 18" of depth clearance under the surface for installation.
- KSM02-12 requires 12" of depth clearance under the surface for installation.
- **Specify keyboard tray separately (see previous page)**

Black:					
KSFK-21	17.5 x 7.5 x 4.75	70	9	.60	\$270
KSFK-18	17.5 x 7.5 x 4.75	70	8.30	.50	\$270
KSFK-12	17.5 x 7.5 x 4.75	85	7.30	.50	\$270

Warm White:					
KSFK-21-W	17.5 x 7.5 x 4.75	85	9	0.7	\$321

Super slim profile accommodates leg clearance requirements of more users. Knobless height adjustment and independent tilt adjustment. Positive tilt lockout available. Height and depth indicators together in dashboard. Compatible with all Global keyboard mechanisms. Good for single users who frequently change positions and for multiple users. Swivels 360°.

- KSFK-21 requires 21.75" of depth clearance under the surface for installation.
- KSFK-18 requires 18" of depth clearance under the surface for installation.
- KSFK-12 requires 12" of depth clearance under the surface for installation.
- **Specify keyboard tray separately (see previous page)**

KEYBOARD MECHANISMS

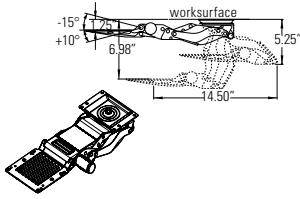

Trackless Keyboard Support Mechanism

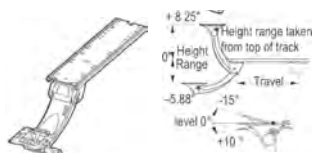

Lift-N-Lock Sit-Stand Mechanism

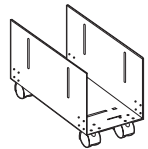

CPU Holder on Casters

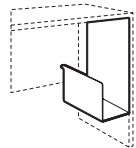

Power Park CPU Holder



CPU Holder on Glide Track

MODEL# DIMENSIONS FREIGHT CLASS WT./LBS. CUBIC FT. LIST PRICE

D x W x H

Black:

KSTRKLS-B	14.5 x 7.5 x 5.25	70	6	0.3	\$379
-----------	-------------------	----	---	-----	--------------

Super slim profile trackless keyboard mechanism designed to fit worksurfaces such as height adjustable tables and benching systems, where space is limited and conventional track mounted keyboard mechanisms will not fit. Knobless height adjustment and independent tilt adjustment. Positive tilt lockout available by special order with extended lead time. Compatible with all Global keyboard trays.

- **Specify keyboard tray separately (see previous page)**

KSM03-21	23.8 x 9 x 9.7	85	11.80	.90	\$434
KSM03-18	19.7 x 7.4 x 8	85	9.70	.70	\$434
KSM03-12	13 x 5 x 5.3	85	6.50	.50	\$434

Ergonomic support for both seated and standing positions. Curved neck allows user closer access to the desk. Positive tilt lockout available. Compatible with all Global keyboard mechanisms. Recommended for single users who alternate between sitting and standing.

- KSM03-21 requires 21.75" of depth clearance under the surface for installation.
- KSM03-18 requires 18" of depth clearance under the surface for installation.
- KSM03-12 requires 12" of depth clearance under the surface for installation.
- **Specify keyboard tray separately (see previous page)**

PCPU-HC	15 x 5 x 10.37	70	8	.45	\$150
---------	----------------	----	---	-----	--------------

Adjusts 5" - 9" in width. Front locking casters. Assembly hardware included. Height without CPU is 10.4". Depth without CPU is 15". Black only.

PCPU-HO	15 x 5-11 x 18	92.5	11.50	1.06	\$131
---------	----------------	------	-------	------	--------------

Desk mounted CPU Holder. Adjusts 5" - 11" in width. Mounting hardware included. Height without CPU is 18". Depth without CPU is 15". Black only.

PCPU-GT	-- x -- x --	100	12.60	1.40	\$309
---------	--------------	-----	-------	------	--------------

Accepts tower CPUs with widths from 3.5" to 9.3" and heights from 12.5" to 22.5". 17" glide track and 360° swivel for easy access to rear of CPU. Steel and engineered resin construction.

LAPTOP STANDS



Laptop Desk

MODEL#	DIMENSIONS	FREIGHT CLASS	WT/LBS.	CUBIC FT.	LIST PRICE
PNT30	D x W x H 15.25 x 26 x 24-29	92.5	17	1.60	\$354

Height adjustable from 24" to 29". Surface is angle adjustable with a palm rest. Can be used for keyboards. Locking casters and leveling glides. Top is 24" w x 13.5" d. Top surface is available in Granite (GPT) only. Black frame only.

DOCUMENT HOLDERS

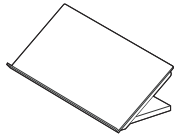

Desktop Document Holder

MODEL#	DIMENSIONS	FREIGHT CLASS	WT/LBS.	CUBIC FT.	LIST PRICE
PDHC200	8 x 16 x 10	85	4.30	.30	\$149

Heavy duty steel document holder. Magnetic line guide. Angle adjustable. Black (BLK) only.



In Line Document Holder*

PMAILDH	-- x -- x --	70	.20	.30	\$151
---------	--------------	----	-----	-----	--------------

Supports letter or legal size documents. Use with Monitor Arms. **Available in Black (BLK) or Silver (SIL).**

TASK LIGHTING

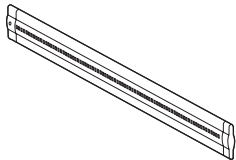

LED Task Light

MODEL#	DIMENSIONS	FREIGHT CLASS	WT/LBS.	CUBIC FT.	LIST PRICE
PLED30	1.5 x 15.5 x .5	150	2	.50	\$392
PLED50	1.5 x 23.5 x .5	150	2	.50	\$451
PLED100	1.5 x 43.5 x .5	125	3	.50	\$523

Energy efficient LED. Ultra slim design. Suitable for hanging under hutch or wallhung units. 6' power cord.

TASK LIGHTING

MODEL# DIMENSIONS FREIGHT CLASS WT/LBS. CUBIC FT. LIST PRICE

D x W x H

Mounting Options for Voyage and Revo Lights:

- Freestanding Base (**FS**)
- Freestanding Base with USB charge port (**FSUSB**) - Add **\$84**.
- Surface Mount (**SM**)
- Clamp Mount (**CM**)

REVO + VOYAGE

MODEL# DIMENSIONS FREIGHT CLASS WT/LBS. CUBIC FT. LIST PRICE

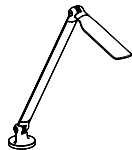

Voyage - Single Arm

LINLAMPS	6 x 6 x 14.1	60	2.66	.01	\$521
----------	--------------	----	------	-----	--------------

Fully articulating body with single arm. 6' power cord. Touch and hold dimming capability, with auto shut-off after 10 hours. Brightness adjustment from 100% to 15%. 18 fractional LEDs, 337 lumens, 3500K color temperature. 85 CRI. 94% post consumer recyclability by weight. Available in Black (BLK), White (WHT) and Silver (SLV). Mounting accessories sold separately (see above). Optional integrated USB port in base (**FSUSB**) allows for charging of mobile devices.

- Occupancy Sensor (**OS**) - Add \$62

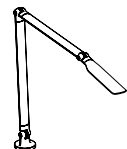

Voyage - Double Arm

LINLAMPD	6 x 6 x 21.6	60	2.66	.01	\$532
----------	--------------	----	------	-----	--------------

Fully articulating body with double arm. 6' power cord. Touch and hold dimming capability, with auto shut-off after 10 hours. Brightness adjustment from 100% to 15%. 18 fractional LEDs, 337 lumens, 3500K color temperature. 85 CRI. 94% post consumer recyclability by weight. Available in Black (BLK), White (WHT) and Silver (SLV). Mounting accessories sold separately (see above). Optional integrated USB port in base (**FSUSB**) allows for charging of mobile devices.

- Occupancy Sensor (**OS**) - Add \$62

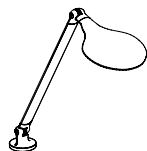

Revo - Single Arm

RNDLAMPS	6 x 6 x 14.1	60	2.66	.01	\$521
----------	--------------	----	------	-----	--------------

Fully articulating body with single arm. 6' power cord. Touch and hold dimming capability, with auto shut-off after 10 hours. Brightness adjustment from 100% to 15%. 18 fractional LEDs, 294 lumens, 3500K color temperature. 85 CRI. 94% post consumer recyclability by weight. Available in Black (BLK), White (WHT) and Silver (SLV). Mounting accessories sold separately (see above). Optional integrated USB port in base (**FSUSB**) allows for charging of mobile devices.

- Occupancy Sensor (**OS**) - Add \$62

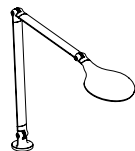

Revo - Double Arm

RNDLAMPD	6 x 6 x 21.6	60	2.66	.01	\$532
----------	--------------	----	------	-----	--------------

Fully articulating body with double arm. 6' power cord. Touch and hold dimming capability, with auto shut-off after 10 hours. Brightness adjustment from 100% to 15%. 18 fractional LEDs, 294 lumens, 3500K color temperature. 85 CRI. 94% post consumer recyclability by weight. Available in Black (BLK), White (WHT) and Silver (SLV). Mounting accessories sold separately (see above). Optional integrated USB port in base (**FSUSB**) allows for charging of mobile devices.

- Occupancy Sensor (**OS**) - Add \$62

Required Specifications

Finish
Mount

Optional Specifications

Occupancy Sensor

POWER / DATA	MODEL#	DIMENSIONS D x W x H	FREIGHT CLASS	WT./LBS.	CUBIC FT.	LIST PRICE
--------------	--------	-------------------------	---------------	----------	-----------	------------



Cable Snake

PCSN01	-- x -- x --	92.5	2.10	.20	\$106
--------	--------------	------	------	-----	--------------

Flexible cable management. Provides access to power/data from floor to underside of worksurface where it attaches. Two pathways within Cable Snake. Length under desk is 31.25". Silver (**SIL**) plastic only.

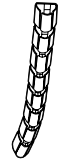

Cable Snake Extension

PCSN01E	- x - x -	92.5	2.1	0.2	\$84
---------	-----------	------	-----	-----	-------------

Extension kit to use with cable snake PCSN01. Additional 8 links extend cable snake up to 49" in length. Ideal for height adjustable tables. Silver plastic only.

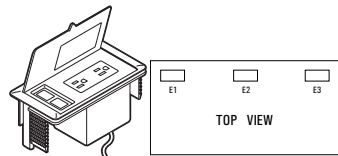

Power/Data Block

PMSPDM	3.5 x 6.5 x 2.75	70	2	.10	\$261
--------	------------------	----	---	-----	--------------

Worksurface power and data module. Two power receptacles and two data receptacles. Specify position and add **\$69** for cutout in worksurface. See diagram E1/E2/E3 for specification location. Black (**BLK**) only.



Mini Adapt Power Module

PEUTEM	3 x 3.8 x 2	70	1	.18	\$175
--------	-------------	----	---	-----	--------------

Two power receptacles. Attaches to edge of table or desk through grommet hole. 6' black cord. Black (**BLK**) only.

Required Specifications
Finish

POWER TOWERS

MODEL# DIMENSIONS FREIGHT CLASS WT/LBS. CUBIC FT. LIST PRICE

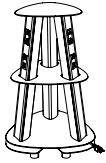

Isle Power Tower

	D x W x H				
PTISL96GB	18 x 18 x 25.5	92.5	68	6.50	\$2147
PTISL96GW	18 x 18 x 25.5	92.5	68	6.50	\$2147
PTISL96SP	18 x 18 x 25.5	92.5	68	6.50	\$2147

Includes twelve (12) 110V power outlets and six (6) rapid charge USB ports. 9' cord with molded plug. Available in Gloss Black (**GB**), Gloss White (**GW**) and Silver Pearl (**SP**) as indicated by last letter of model number.

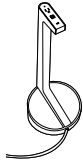

Vesta Portable Power Tower

PPVST1WF	12 x 12 x 28.25	250	10	4.30	\$1737
----------	-----------------	-----	----	------	---------------

Includes one 110V power outlet, two USB-A and one USB-C charging ports. 10' cord with plug. Matte White finish with Fog inserts.

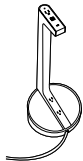

Vesta Portable Power Tower

PPVST3WF	12 x 12 x 28.25	250	10	4.30	\$1737
----------	-----------------	-----	----	------	---------------

Includes three 110V power outlets (one on top, two on base), two USB-A and one USB-C charging ports. 10' cord with plug. Matte White finish with Fog inserts.

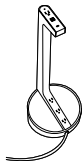

Vesta Portable Power Tower

PPVST4WF	12 x 12 x 28.25	250	10	4.30	\$1737
----------	-----------------	-----	----	------	---------------

Includes four 110V power outlets (one on top, three on base), two USB-A and one USB-C charging ports. 10' cord with plug. Matte White finish with Fog inserts.

Required Specifications

Finish

POWER / DATA - COVE MINI

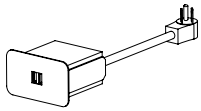

Cove Mini - Charging USB

MODEL#	DIMENSIONS D x W x H	FREIGHT CLASS	WT./LBS.	CUBIC FT.	LIST PRICE
COV-SM-U-_-108	--	70	1.5	.25	\$292

Retrofits into any AG or POG grommet cutout (grommet cover must be removed). Includes two 2.1 AMP USB charging ports. Requires 2" clearance below the worksurface. 9' black cord.

- This unit utilizes the entire grommet, eliminating available wire pass thru
- Replace _ with **B** for **Black**
- Replace _ with **S** for **Silver**

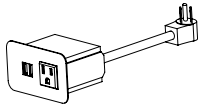

Cove Mini - Power & Charging USB

COV-SM-1U-_-108	--	70	1.5	.25	\$311
-----------------	----	----	-----	-----	--------------

Retrofits into any AG or POG grommet cutout (grommet cover must be removed). Includes one power outlet and two 2.1 AMP USB charging ports. Requires 2" clearance below the worksurface. 9' black cord.

- This unit utilizes the entire grommet, eliminating available wire pass thru
- Replace _ with **B** for **Black**
- Replace _ with **S** for **Silver**

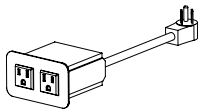

Cove Mini - Power

COV-SM-2-_-108	--	70	1.5	.25	\$192
----------------	----	----	-----	-----	--------------

Retrofits into any AG or POG grommet cutout (grommet cover must be removed). Includes two power outlets. Requires 2" clearance below the worksurface. 9' black cord.

- This unit utilizes the entire grommet, eliminating available wire pass thru
- Replace _ with **B** for **Black**
- Replace _ with **S** for **Silver**

POWER / DATA

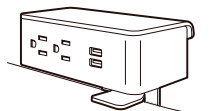

Edge Mounted 2 Power/USB

MODEL#	DIMENSIONS	FREIGHT CLASS	WT./LBS.	CUBIC FT.	LIST PRICE
PS305057	5.5 x 3.2 x 3	60	3.01	0.05	\$298
PS305002	5.5 x 3.2 x 3	60	3.01	0.05	\$298

Edge mounted power module with two power outlets and two 2.1 amp USB ports. Edge clamp accommodates worksurfaces 0.5" to 1.5" thick; fastened with thumb screws. 6' cord.

- PS305057 - White module with Silver bracket.
- PS305002 - Black module with Silver bracket



Under Mounted 2 Power/USB

PS305157	5.5 x 2.8 x 1.8	60	3.2	0.05	\$258
PS305102	5.5 x 2.8 x 1.8	60	3.2	0.05	\$258

Under mount power module with two power outlets and two 2.1 amp USB ports. Mountable under most worksurfaces. Installation template provided. 6' cord.

- PS305157 - White module with Silver bracket
- PS305102 - Black module with Silver bracket.

Required Specifications

Finish

POWER / DATA

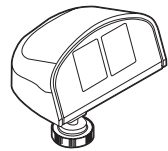

Power/Data Module

MODEL# DIMENSIONS FREIGHT CLASS WT/LBS. CUBIC FT. LIST PRICE

	D x W x H				
PEUTDM	3 x 3.75 x 2	92.5	2	.18	\$148

Spaces for two data plugs (not included) with Common Adaptors. Attaches to edge of table or desk through grommet hole. 6' black cord. Black (BLK) only.

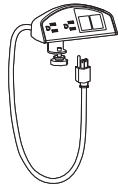

Power/Data Module

PEUEDM	4 x 6.5 x 2.5	92.5	2	.18	\$270
--------	---------------	------	---	-----	-------

Consisting of two electrical outlets, spaces for two data plugs with Adaptors, 6' power cord. Black (BLK) only.

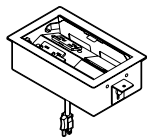

Voice/Data Block

PLRTM202B	11 x 6.8 x 3.5	92.5	7	0.67	\$477
PLRTM202T	11 x 6.8 x 3.5	92.5	7	0.67	\$477

Power only included, specify telecom options separately. Includes four simplex outlets on top and one on bottom. 10' cord. Includes two telecom knockouts. Available in Black (B) and Tungsten (T) - indicated by last letter of model number. Surface access door. Cut-out option U1, U2 or U3 to be specified when ordering. Available on Zira Boardroom, Kadin and Zook tables only.

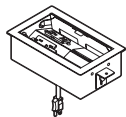

Power/USB Block

PM202USBB	11 x 6.8 x 3.5	92.5	7	0.67	\$669
PM202USBT	11 x 6.8 x 3.5	92.5	7	0.67	\$669

Conference table power module with recessed door. Includes two AC power simplexes (two receptacles), one USB duplex (USB charging), two telecom knock outs and one simplex on the bottom and 10' power cord. Box available in Black (B) or Tungsten (T) as indicated by last character of model number. Duplexes finish White only. Cut-out option U1, U2 or U3 to be specified when ordering. Available on Zira Boardroom, Kadin and Zook tables only.

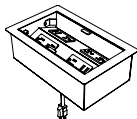

Power/USB Block

PFPD400RB	11 x 6.8 x --	92.5	7	0.67	\$683
PFPD400RT	11 x 6.8 x --	92.5	7	0.67	\$683

Conference table power module with recessed door. Includes two duplexes, two USB duplexes (USB charging), and one simplex on the bottom and 10' power cord. Box available in Black (B) or Tungsten (T) as indicated by last character of model number. Duplexes finish White only. Cut-out option U1, U2 or U3 to be specified when ordering. Available on Zira Boardroom, Kadin and Zook tables only.

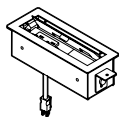

Voice/Data Block

PLRTM101B	11 x 4.3 x 3.5	125	4.65	0.67	\$411
PLRTM101T	11 x 4.3 x 3.5	125	4.65	0.67	\$411

Power only included, specify telecom options separately. Includes two simplex outlets on top and one on bottom. 10' cord. Includes one telecom knockout. Available in Black (B) and Tungsten (T) - indicated by last letter of model number. Surface access door. Cut-out option K1, K2 or K3 to be specified when ordering.

Required Specifications

Finish

POWER / DATA

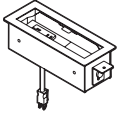

Power/USB Block

MODEL#	DIMENSIONS D x W x H	FREIGHT CLASS	WT./LBS.	CUBIC FT.	LIST PRICE
PM101USBB	11 x 4.3 x 3.5	70	6	0.3	\$506
PM101USBT	11 x 4.3 x 3.5	70	6	0.3	\$506

Conference table power module with recessed door. Includes one AC power simplex (one receptacle), one USB duplex (USB charging), one telecom knock out and one simplex on the bottom and 10' power cord. Box available in Black (**B**) or Tungsten (**T**) as indicated by last character of model number. Duplexes finish White only. Cut-out option **K1**, **K2** or **K3** to be specified when ordering.

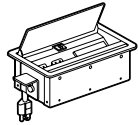

Power/Data Block

PLCTM101B	9 x 5.5 x -	70	6	0.3	\$216
PLCTM101T	9 x 5.5 x -	70	6	0.33	\$216

Power only included, specify telecom options separately, see above. Includes two simplex outlets on top and one on bottom. 10' cord. Includes one telecom knockout. Available in Black (**B**) and Tungsten (**T**) - indicated by last letter of model number. Surface access door. Cut-out option **A1**, **A2** or **A3** to be specified when ordering.

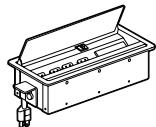

Power/Data Block

PLCTM102B	12 x 5.5 x -	125	5	0.67	\$311
PLCTM102T	12 x 5.5 x -	125	5	0.67	\$311

Power only included, specify telecom options separately, see above. Includes four simplex outlets on top and one on bottom. 10' cord. Includes one telecom knockout. Available in Black (**B**) and Tungsten (**T**) - indicated by last letter of model number. Surface access door. Cut-out option **J1**, **J2** or **J3** to be specified when ordering.

TELECOM PLATES

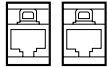

Telecom Plate - 2 x 6

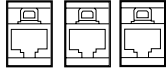

Telecom Plate - 3 x 6

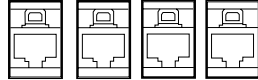

Telecom Plate - 4 x 6

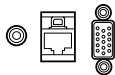

Telecom Plate - 3T5V

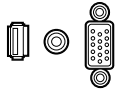

Telecom Plate - 3SVH

MODEL#	DIMENSIONS	FREIGHT CLASS	WT/LBS.	CUBIC FT.	LIST PRICE
--------	------------	---------------	---------	-----------	------------

D x W x H

PTEL01	- x - x -	70	0.01	0.05	\$109
--------	-----------	----	------	------	--------------

Includes 2 x RJ45 cat 6 data. Black telecom plate. To be hardwired by data contractor.

PTEL02	- x - x -	70	0.01	0.05	\$137
--------	-----------	----	------	------	--------------

Includes 2 x RJ45 cat 6 data and 1 RJ11 cat phone. Black telecom plate. To be hardwired by data contractor.

PTEL03	- x - x -	70	0.01	0.05	\$211
--------	-----------	----	------	------	--------------

Includes 4 x RJ45 cat 6 data. Black telecom plate. To be hardwired by data contractor.

PTEL04	- x - x -	70	0.01	0.05	\$188
--------	-----------	----	------	------	--------------

Includes 1 x RJ45 cat 6 data, mini stereo and 15 pin HD VGA. Black telecom plate. To be hardwired by data contractor.

PTEL05	- x - x -	70	0.01	0.05	\$257
--------	-----------	----	------	------	--------------

Includes mini stereo, 15 pin HD VGA and HDMI. Black telecom plate.

WIRE MANAGEMENT

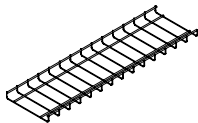

Power/Data Cable Basket

MODEL#	DIMENSIONS	FREIGHT CLASS	WT/LBS.	CUBIC FT.	LIST PRICE
--------	------------	---------------	---------	-----------	------------

BRTCB76KIT	8 x 34 x 1	70	1.56	.15	\$193
BRTCB70	8 x 70 x 1	100	3.22	.34	\$140
BRTCB64	8 x 64 x 1	92.5	2.94	.29	\$129
BRTCB58	8 x 58 x 1	92.5	2.66	.26	\$126
BRTCB52	8 x 52 x 1	100	2.39	.24	\$118
BRTCB46	8 x 46 x 1	92.5	2.16	.21	\$112
BRTCB40	8 x 40 x 1	70	1.80	.18	\$105
BRTCB34	8 x 34 x 1	70	1.56	.15	\$101
BRTCB28	8 x 28 x 1	70	1.20	.13	\$89
BRTCB22	8 x 22 x 1	70	1.01	.10	\$84
BRTCB16	8 x 16 x 1	70	.73	.07	\$78
BRTCB8	8 x 8 x 1	70	.36	.03	\$71

Shallow, 8" wide basket manages cable excess and serves to manage cords and cables. It can be easily unclipped from spring steel brackets (included) to rearrange cable connections from below worksurface. Spring steel brackets can suspend the Cable Basket below the worksurface where it keeps the cords and cables off the floor and manages them along the horizontal plane - between floor monuments and Storage Vertical Cable Manager, for example. Tall storage cabinet's legs provide easy access to the Cable Basket where it can easily be unclipped from spring steel brackets to rearrange cable connections. Steel wire construction, chrome finish baskets; black spring steel hanging brackets, fasteners.

OFFICE ACCESSORIES



Wire Manager

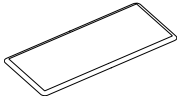

Anti-Fatigue Mat



Vertical Wire Manager

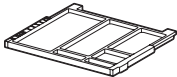

Pencil Drawer



Coat Tree



Coat Tree

MODEL#	DIMENSIONS D x W x H	FREIGHT CLASS	WT./LBS.	CUBIC FT.	LIST PRICE
PEWM5.5	2 x 66 x 2	70	.60	.10	\$156
PEWM5	2 x 60 x 2	70	.60	.10	\$131
PEWM4.5	2 x 54 x 2	70	.50	.10	\$117
PEWM4	2 x 48 x 2	70	.50	.10	\$106
PEWM3.5	2 x 42 x 2	70	.40	.10	\$91
PEWM3	2 x 36 x 2	70	.40	.10	\$81
PEWM2.5	2 x 30 x 2	70	.30	.10	\$66
PEWM2	2 x 24 x 2	70	.30	.10	\$55
PEWM1.5	2 x 18 x 2	70	.20	.10	\$42
PEWM1	2 x 12 x 2	70	.20	.10	\$30

Plastic tray flexes to receive and hold electrical and data wires. Quickly attaches with two strips of double-sided tape. Black (**BLK**) only.

PAFM3018	29.4 x 17.63 x .75	85	4.4	0.3	\$125
PAFM4820	48 x 20 x .75	85	7.7	0.59	\$201

Polyurethane anti-fatigue mat offers increased comfort and helps reduce strain while standing. Tapered, no-curl edges prevent tripping hazards. Anti-slip backing is suitable for low pile carpet or hard flooring. Black only.

PEVWM	2 x 22 x 2	70	.30	.10	\$53
-------	------------	----	-----	-----	-------------

From underside of worksurface to bottom panel. Capable of holding electrical and data wires in a vertical position. Black (**BLK**) only. Attaches with two strips of double-sided tape.

PEEPD	18 x 22.5 x 1.5	250	2	.70	\$137
-------	-----------------	-----	---	-----	--------------

Provides storage for writing instruments and small items at the worksurface. Attaches to the underside of the worksurface with included drawer slides. Black ABS plastic.

PCOS2	25 x 25 x 60	300	8	4.67	\$366
PCOS3	25 x 25 x 60	300	8	4.67	\$366

Square tube metal frame, complete with four Chrome double hooks. Adjustable glides. 60" high. Ships UPS.

- 3 per carton
- PCOS2 is finished in Black. PCOS3 is finished in Chrome.

PCT	25 x 25 x 65	250	6	3	\$469
-----	--------------	-----	---	---	--------------

Square tube. Complete with four satin brass double hooks. 65" high. Available in the following finishes: Absolute (AAM), Black (BKM), Cherry (ACM), Cherry Latte (CLM), Cocoa Vanilla (CVM), English Oak (EOM), Fruitwood (TFM), Honey (AHM), Gray (HGM), Mahogany (TMM), Maple (AVM), Medium Walnut (MWM), Night (ASM), Sandy Beach (SBM), Walnut (TWM), White (WHM) and Winter Cherry (WCM). Ships UPS.

- 1 per carton

Required Specifications

Finish (PCT only)

OFFICE ACCESSORIES

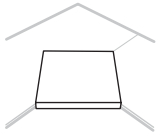

Corner Keyboard Plate

MODEL#	DIMENSIONS	FREIGHT CLASS	WT/LBS.	CUBIC FT.	LIST PRICE
--------	------------	---------------	---------	-----------	------------

D x W x H					
PEEOCKS	18 x 18 x 1.12	70	6	.30	\$90

Converts two 1" thick worksurfaces at 90° into a keyboard support corner. Finished in Black (BLK) and Tungsten 2 (TU2) epoxy coating.

DENVER BOOKCASES

BOOKCASE NOTES

- Available to either match or coordinate with most Global laminate desk series.
- Sturdy 36" wide construction.
- All units include fixed and adjustable shelves.
- Standard with Black finish back panel.

AWC Avant Cherry
QTM Quartered Mahogany

AWH Avant Honey
TFW Tiger Fruitwood

BLK Black
TWL Tiger Walnut

DES Dark Espresso
WCR Winter Cherry

MODEL#	DIMENSIONS	FREIGHT CLASS	WT/LBS.	CUBIC FT.	LIST PRICE
--------	------------	---------------	---------	-----------	------------

ZBC72	12 x 36 x 72	60	101	2.75	\$501
-------	--------------	----	-----	------	-------

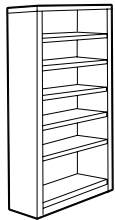

Denver Bookcase - 72" high

One fixed heavy duty shelf and four adjustable shelves. Shipped RTA (ready to assemble).
• All Denver Bookcases are standard with Black finish back panel.

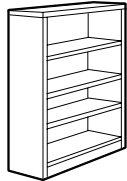

Denver Bookcase - 48" high

ZBC48	12 x 36 x 48	60	71	1.86	\$388
-------	--------------	----	----	------	-------

Three adjustable shelves. Shipped RTA (ready to assemble).
• All Denver bookcases are standard with Black finish back panel.

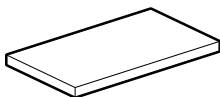

Bookcase Shelf

ZESH	12 x 34 x 1	60	10	.30	\$106
------	-------------	----	----	-----	-------

Extra shelf for bookcases. 1" thick.

Required Specifications

Finish

BOARDROOM ACCESSORIES

MODEL#

DIMENSIONS

FREIGHT CLASS

WT/LBS.

CUBIC FT.

LIST PRICE

D x W x H

CONFERENCE CABINET NOTES

- Visual boards feature a self edge all around.
- Available finishes:

ACJ	Absolute Acajou	ASN	Asian Night	AWC	Avant Cherry	AWH	Avant Honey
BLK	Black	BRC	Brushed Cobalt	DES	Dark Espresso	DWT	Designer White
HGT	Hayden Grey	QTM	Quartered Mahogany	SOG	Storm Grey	TFW	Tiger Fruitwood
TWL	Tiger Walnut	WHC	White Chocolate	WGY	Willow Grey	WCR	Winter Cherry

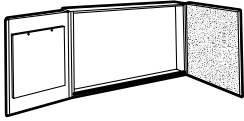

Visual Board

GVB4848	4 x 48 x 48	85	122	9.25	\$1274
AVB4848	4 x 48 x 48	70	135	9	\$1240

Includes white board and two side opening doors containing cork board on right door and 50-sheet paper writing pad on left door. Marker board can be used for projection. Set of 4 dry markers and eraser included.

- **NOTE:** Care should be taken to mount the units. Units should be mounted to wall studs using correct fasteners. Failure to do so may result in collapse of the unit and subsequent personal injury. **Mounting hardware not included.** Mounting hardware used should be based on wall material. Consult an installation professional for proper wall mounting.

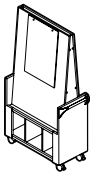

Visual Board

Z361872VB	36 x 18 x 72	250	187	38.50	\$2222
-----------	--------------	-----	-----	-------	---------------

Angled visual board with paper pad on one side and dry erase board on the opposite side. Unique push handles are standard. Locking casters included. Decorative aluminum trim is standard on the lip of each shelf. Height aligns with 36" buffets. Shipped RTA (ready to assemble).

PENCIL DRAWERS

MODEL#

DIMENSIONS

FREIGHT CLASS

WT/LBS.

CUBIC FT.

LIST PRICE

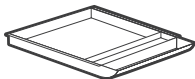

Pencil Drawer

W1624PDR	16 x 24 x 2.25	92.5	5	.50	\$272
W1518PDR	18 x 15 x 2.25	92.5	4	.40	\$204

Black ABS plastic. Provides space for writing instruments and small items at the workspace. Attaches to underside of any 24"D and 30"D worksurface with included roller slides. Shipped RTA (ready to assemble).

- May be used with all casegoods.

Required Specifications

Finish (Visual Board)

CENTER DRAWERS **MODEL#** **DIMENSIONS** **FREIGHT CLASS** **WT/LBS.** **CUBIC FT.** **LIST PRICE**

D x W x H

CENTER DRAWER NOTES

• Center drawers must be dealer or end user installed. Drawers do not fill entire center space opening. Approximate kneespace widths are:

30" x 60" DP	25½"	30" x 66" DP	31½"
30" x 72" DP	37½"	30" x 66"/20" x 40" L	22½"
30" x 66"/24" x 48" L	24½"	36" x 72"/24" x 48" L	30½"

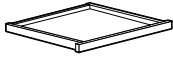

Center Drawer

CD20	18 x 20 x 3	100	8	1	\$160
------	-------------	-----	---	---	--------------

Laminate drawer front is attached to a 4-sided frame. Recommended for use on small L-shaped units, and on 30" x 60" and 30" x 66" desks. Specify finish from list available in each series. **Not available** on StreamLINE series.

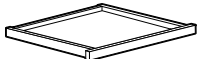

Center Drawer

CD28	18 x 28 x 3	150	5	1	\$210
------	-------------	-----	---	---	--------------

Laminate drawer front is attached to a 4-sided frame. Recommended for use on 36" x 72" desks. Specify finish from list available in each series. **Not available** on StreamLINE series.

KEYBOARD DRAWERS **MODEL#** **DIMENSIONS** **FREIGHT CLASS** **WT/LBS.** **CUBIC FT.** **LIST PRICE**

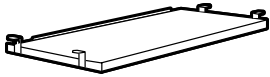

Keyboard Shelf

KS20	11 x 20 x 3.5	92.5	10	1	\$199
------	---------------	------	----	---	--------------

Pull-out laminate shelf. Specify finish from list available in each series.

- **Not available** on StreamLINE or Adaptabilities Series - see page 41 for comparable Adaptabilities option.

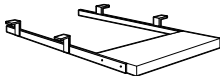

Keyboard Drawer

MPOKL	11 x 24 x 3.5	92.5	10	1	\$204
-------	---------------	------	----	---	--------------

Pull-out laminate drawer. Specify finish from list available in each series.

- **Not available** on StreamLINE or Adaptabilities Series - see page 41 for comparable Adaptabilities option.

ACCESSORIES **MODEL#** **DIMENSIONS** **FREIGHT CLASS** **WT/LBS.** **CUBIC FT.** **LIST PRICE**



Wire Manager Grommet

AG1	1.875 d x 3.25 w	100	--	--	\$69
AG2					
AG3					

Rectangular **black** surface mount that can be factory installed in any worksurface. Indicate position - left (**AG1**), center (**AG2**) or right (**AG3**). **See individual Series Notes for further details.** To order a grommet cover only, please specify **GEN160-UN** - \$18 list each.



L Bracket

MLB90	--	70	1	.01	\$43
-------	----	----	---	-----	-------------

Used to attach worksurfaces to end panels.



Flat Bracket

M393	--	70	1	.01	\$40
------	----	----	---	-----	-------------

Used as a mending plate to give additional worksurface support.

Required Specifications

Finish (Drawers)

D DESK ACCESSORIES

DRAWER HANDLES



Silver Handle (HV)

MODEL#	DIMENSIONS D x W x H	FREIGHT CLASS	WT/LBS.	CUBIC FT.	LIST PRICE
GEN225-SIL	--	70	1	.01	\$23

Silver finish, square edge handle style. **For use on pedestals and all lateral files.**

- This handle has a measurement of 96mm center to center.
- Drawer handles on this page are for purchase. Installation is done by the customer. To purchase as a factory installed option on **Zira** desks, credenzas and returns, see series notes for option code and price.



Matte Black Handle (HU)

GEN225-BLK	--	70	1	.01	\$23
------------	----	----	---	-----	-------------

Black matte finish, square edge handle style. **For use on pedestals and all lateral files.**

- This handle has a measurement of 96mm center to center.
- Drawer handles on this page are for purchase. Installation is done by the customer. To purchase as a factory installed option on **Zira** desks, credenzas and returns, see series notes for option code and price.



Flared Brass Handle (HW)

GEN217	--	70	1	.01	\$23
--------	----	----	---	-----	-------------

Satin brass finish, flared handle style. **For use on pedestals and all lateral files.**

- This handle has a measurement of 96mm center to center.
- Drawer handles on this page are for purchase. Installation is done by the customer. To purchase as a factory installed option on **Zira** desks, credenzas and returns, see series notes for option code and price.



Flared Black Handle (HX)

GEN165	--	70	1	.01	\$23
--------	----	----	---	-----	-------------

Black matte finish, flared handle style. **For use on pedestals and all lateral files.**

- This handle has a measurement of 96mm center to center.
- Drawer handles on this page are for purchase. Installation is done by the customer. To purchase as a factory installed option on **Zira** desks, credenzas and returns, see series notes for option code and price.



Flared Silver Handle (HS)

GEN189-HS	--	70	1	.01	\$23
-----------	----	----	---	-----	-------------

Silver finish, flared handle style. **For use on pedestals and all lateral files.**

- This handle has a measurement of 96mm center to center.
- Drawer handles on this page are for purchase. Installation is done by the customer. To purchase as a factory installed option on **Zira** desks, credenzas and returns, see series notes for option code and price.



Dimpled Nickel Handle (HZ)

GEN190	--	70	1	.01	\$23
--------	----	----	---	-----	-------------

Nickel matte finish, dimpled handle style. **For use on pedestals and all lateral files.**

- This handle has a measurement of 96mm center to center.
- Drawer handles on this page are for purchase. Installation is done by the customer. To purchase as a factory installed option on **Zira** desks, credenzas and returns, see series notes for option code and price.



Crescent Black Handle (H0)

GEN256	--	70	1	.01	\$23
--------	----	----	---	-----	-------------

Black matte finish, crescent handle style. **For use on pedestals and all lateral files.**

- This handle has a measurement of 96mm center to center.
- Drawer handles on this page are for purchase. Installation is done by the customer. To purchase as a factory installed option on **Zira desks, credenzas and returns only**, see series notes for option code and price.

DRAWER HANDLES

MODEL# DIMENSIONS FREIGHT CLASS WT/LBS. CUBIC FT. LIST PRICE

D x W x H



Bar Silver Handle (HQ)

CS0003-SIL	--	70	1	.01	\$23
------------	----	----	---	-----	-------------

Silver finish, bar handle style **For use on pedestals and all lateral files.**

- This handle has a measurement of 96mm center to center.
- Drawer handles on this page are for purchase. Installation is done by the customer. To purchase as a factory installed option on **Zira desks, credenzas and returns only**, see series notes for option code and price.



Bar Black Handle (HR)

CS0003-BLK	--	70	1	.01	\$23
------------	----	----	---	-----	-------------

Black finish, bar handle style **For use on pedestals and all lateral files.**

- This handle has a measurement of 96mm center to center.
- Drawer handles on this page are for purchase. Installation is done by the customer. To purchase as a factory installed option on **Zira desks, credenzas and returns only**, see series notes for option code and price.

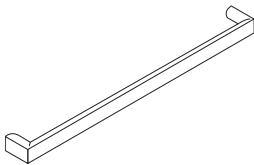

Bridges II Handle

BRH1	--	70	1	.01	\$27
------	----	----	---	-----	-------------

Silver Finish, square edged handle style. For use on all pedestals and storage cabinets with handles.

- This handle has a measurement of 128mm center to center.
- Drawer handles on this page are for purchase. Installation is done by the customer. To purchase as a factory installed option on **Bridges II pedestals and cabinets only**, see series notes for option code and price.

T TABLE POWER + TECHNOLOGY SOLUTIONS™ - NOTES

- Global is pleased to offer a range of sophisticated electrical and technology options for training and conference tables.
- Worksurface cutouts for units must be specified separately, please see appropriate product note pages for details.
- Daisy chaining is generally defined as having multiple power units connect to one another from a single electrical infeed source.
- The daisy-chain units below utilize a 4-wire, 2 circuit system (when hardwired by a licensed electrician to a building power source) or can run a single circuit (when utilizing the 42AP1-72 plug and play infeed).
- The following maximums are to National Electric Code (NEC) – some local codes vary from NEC code – it is the customer's responsibility to follow all applicable local codes and guidelines.

Product	Max units per circuit
Villa I	8 units per circuit
Villa II	4 units per circuit
Villa USB	8 units per circuit
Oasis Mini A	3 units per circuit
Oasis Mini B	3 units per circuit

Electrical System

4-2 Wiring Schematic
 4-Wire Shared Neutral
 Complies with National Electric Code
 UL Listed
 All circuits rated for 20 AMP

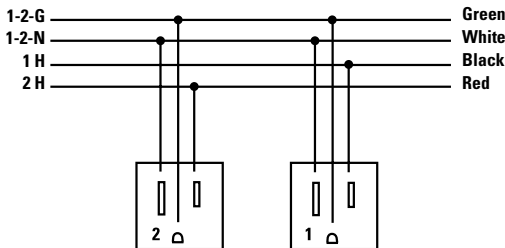

VILLA I, VILLA II AND VILLA USB DETAILS

- Each Villa unit is available two ways. Corded units includes three-prong plugs to connect directly into a standard outlet. DaisyLink kits can be specified separately to daisy-chain multiple units off of a single infeed. Infeeds are specified separately.
- Villa I units include two power outlets and either two knockouts or two data ports included, **all accessible at the surface**.
- Villa II units include two power outlets and either two knockouts for data or two data ports included accessible at the surface. Another two power outlets are **accessible below the surface**.
- Villa USB includes two power outlets, two 2.1 AMP charging USB ports and either two data knockouts or two data ports included, **all accessible at the surface**.

OASIS MINI DETAILS

- Each Oasis Mini (except for Chicago Mini Oasis) is available two ways. Corded units includes three-prong plugs to connect directly into a standard outlet. DaisyLink units must have interconnecting cords specified separately to daisy-chain multiple units off of a single infeed. Infeeds are specified separately.
- Oasis Mini A units includes six power outlets and two telecom plate knockouts
- Oasis Mini B units includes four power outlets and three telecom plate knockouts
- Oasis Mini USB units include six power outlets, two 2.1 AMP charging USB ports and one telecom plate knockouts

TELECOM PLATE DETAILS

- Telecom plates are for use on Oasis Mini units only, providing a means to provide different types of telephone, data and audio visual connections to the worksurface. For every telecom plate knockout on a Oasis Mini unit, please specify one telecom plate. If telecom plates are not required, it is recommended blank telecom plates are specified - see page xxx for details.

EXAMPLE LAYOUTS - TRAINING TABLES

- Single Power Block Kits Available on training tables 36" – 72" (**must specify V2 cutout on table**):
- Each single block kit includes 1 Power Block and 1 Grommet Cover, 1 Female/Female Interconnecting Cable and 1 Female/Male Interconnecting Cable. Cable clamps for management of these cables are also included.

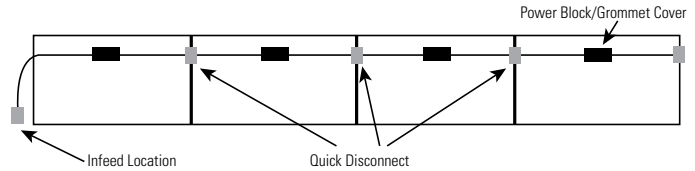

- Double Power Block Kits Available on 60", 66" and 72" (must specify V1 and V3 cutout on table):
- Each double block kit includes 2 Power Blocks and 2 Grommet Covers, 2 Female/Female Interconnecting Cable and 1 Female/Male Interconnecting Cable. Cable clamps for management of these cables are also included.

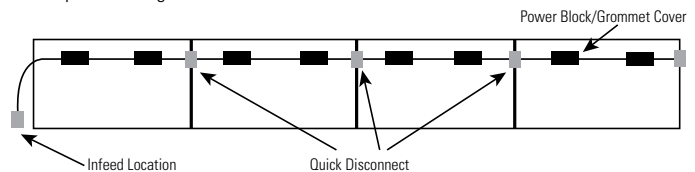

VILLA CUTOUTS

- Optional Villa cutout available in standard worksurface locations (left, center or right) **for Rectangular Tables**. Order as: **V1, V2 or V3**. **Add \$69 for each cutout**.
- Villa cutouts may be placed at non-standard locations. Please contact customer service.

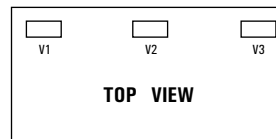

OASIS MINI CUTOUTS

- Optional Oasis Mini cutout available in standard worksurface locations (left, center or right) **for Rectangular Tables**. Order as: **M1, M2 or M3**. **Add \$69 for each cutout**.
- Oasis Mini cutouts may be placed at non-standard locations. Please contact customer care.
- **Oasis Mini is only available on Zira Boardroom Tables**

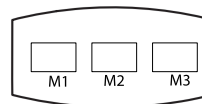

VILLA I, CENTER POSITION- DAISYLINK KITS

MODEL#	DIMENSIONS	FREIGHT CLASS	WT./LBS.	CUBIC FT.	LIST PRICE
--------	------------	---------------	----------	-----------	------------

D x W x H

VIF-41-DKO_72SK	--	70	9	.45	\$383
VIF-41-DKO_66SK	--	70	9	.45	\$383
VIF-41-DKO_60SK	--	70	9	.45	\$383
VIF-41-DKO_54K	--	70	9	.45	\$383
VIF-41-DKO_48K	--	70	9	.45	\$383
VIF-41-DKO_42K	--	70	9	.45	\$383
VIF-41-DKO_36K	--	70	9	.45	\$383

Villa Power Base

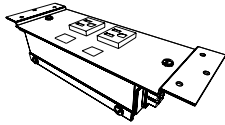

Villa Flush Lid



Data Knockouts, No Data Ports



42 FF Cable



42 FM Cable

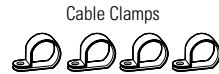

Cable Clamps

Includes **one power block** with **two power receptacles** and two knockouts for data, grommet cover, one female/female interconnecting cable, one female/male interconnecting cable and four cable clamps. **V2 cutout must be specified on training table** (see product notes section for more details and cutout upcharge). **Power Infeed required and sold separate** (see page 563). For multiple circuit configurations, please contact customer service. UL listed and CSA Certified.

- Replace _ with **B** for **Black**
- Replace _ with **S** for **Silver Pearl**
- Villa DaisyLink kits are not recommended for use on 2gether tables or Zira Boardroom Tables

VIF-41-D_-72SK	--	70	9	.45	\$502
VIF-41-D_-66SK	--	70	9	.45	\$502
VIF-41-D_-60SK	--	70	9	.45	\$502
VIF-41-D_-54K	--	70	9	.45	\$502
VIF-41-D_-48K	--	70	9	.45	\$502
VIF-41-D_-42K	--	70	9	.45	\$502
VIF-41-D_-36K	--	70	9	.45	\$502

Villa Power Base

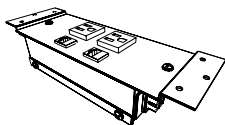

Villa Flush Lid



Data Knockouts, Data Ports Included

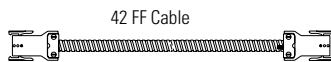

42 FF Cable



42 FM Cable



Cable Clamps

Includes **one power block** with **two power receptacles** and **two RJ45** Cat 6 Data, grommet cover, one female/female interconnecting cable, one female/male interconnecting cable and four cable clamps. **V2 cutout must be specified on training table** (see product notes section for more details and cutout upcharge). **Power Infeed required and sold separate** (see page 563). For multiple circuit configurations, please contact customer service. UL listed and CSA Certified.

- Replace _ with **B** for **Black**
- Replace _ with **S** for **Silver Pearl**
- Villa DaisyLink kits are not recommended for use on 2gether tables or Zira Boardroom Tables

Required Specifications

Finish
Power Infeed
Cutout location

T TABLE POWER + TECHNOLOGY SOLUTIONS

VILLA I, CENTER POSITION- DAISYLINK KITS

MODEL# DIMENSIONS FREIGHT CLASS WT./LBS. CUBIC FT. LIST PRICE

D x W x H

VIF-41-UDKO_-36K	--	70	10	.45	\$526
VIF-41-UDKO_-42K	--	70	10	.45	\$526
VIF-41-UDKO_-48K	--	70	10	.45	\$526
VIF-41-UDKO_-54K	--	70	10	.45	\$526
VIF-41-UDKO_60SK	--	70	10	.45	\$526
VIF-41-UDKO_66SK	--	70	10	.45	\$526
VIF-41-UDKO_72SK	--	70	10	.45	\$526

Villa Power Base

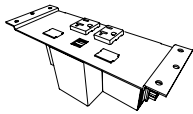

Villa Flush Lid



Villa I USB
Data Knockouts, No Data Ports

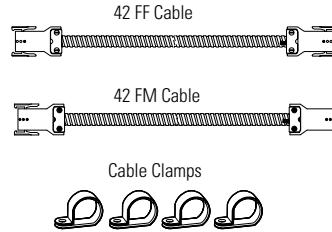

Includes **one power block with two power receptacles, two 2.1 AMP USB charging ports** and two knockouts for data, grommet cover, one female/female interconnecting cable, one female/male interconnecting cable and four cable clamps. **V2 cutout must be specified on training table** (see product notes section for more details and cutout upcharge). **Power Infeed required and sold separate** (see page 563). For multiple circuit configurations, please contact customer service. UL listed and CSA Certified.

- Replace _ with **B** for **Black**
- Replace _ with **S** for **Silver Pearl**
- Villa DaisyLink kits are not recommended for use on 2gether tables or Zira Boardroom Tables
- Not compatible with Terina tables or Junction wire managers (JNECxx)

VIF-41-UD_-36K	--	70	10	.45	\$644
VIF-41-UD_-42K	--	70	10	.45	\$644
VIF-41-UD_-48K	--	70	10	.45	\$644
VIF-41-UD_-54K	--	70	10	.45	\$644
VIF-41-UD_60SK	--	70	10	.45	\$644
VIF-41-UD_66SK	--	70	10	.45	\$644
VIF-41-UD_72SK	--	70	10	.45	\$644

Villa Power Base

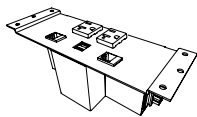

Villa Flush Lid



Villa I USB
Data Knockouts, Data Ports Included

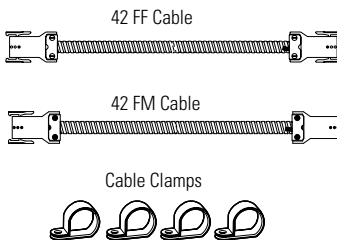

Includes **one power block with two power receptacles, two 2.1 AMP USB charging ports** and two RJ45 Cat 6 for data, grommet cover, one female/female interconnecting cable, one female/male interconnecting cable and four cable clamps. **V2 cutout must be specified on training table** (see product notes section for more details and cutout upcharge). **Power Infeed required and sold separate** (see page 563). For multiple circuit configurations, please contact customer service. UL listed and CSA Certified.

- Replace _ with **B** for **Black**
- Replace _ with **S** for **Silver Pearl**
- Villa DaisyLink kits are not recommended for use on 2gether tables or Zira Boardroom Tables
- Not compatible with Terina tables or Junction wire managers (JNECxx)

Required Specifications

Finish
Power Infeed
Cutout location

VILLA II, CENTER POSITION - DAISYLINK KITS

Villa II Power Base

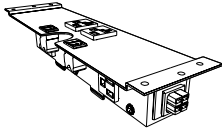

Villa II Flush Lid



Data Knockouts, No Data Ports

MODEL#	DIMENSIONS	FREIGHT CLASS	WT/LBS.	CUBIC FT.	LIST PRICE
--------	------------	---------------	---------	-----------	------------

D x W x H

VIF2-41-DKO_72SK	--	65	12	.45	\$454
VIF2-41-DKO_66SK	--	65	12	.45	\$454
VIF2-41-DKO_60SK	--	65	12	.45	\$454
VIF2-41-DKO_54K	--	65	12	.45	\$454
VIF2-41-DKO_48K	--	65	12	.45	\$454
VIF2-41-DKO_42K	--	65	12	.45	\$454
VIF2-41-DKO_36K	--	65	12	.45	\$454

42 FF Cable



42 FM Cable



Cable Clamps



Includes **one power block** with **four power receptacles** (two worksurface accessible, two below worksurface) and two knockouts for data, grommet cover, one female/female interconnecting cable, one female/male interconnecting cable and four cable clamps. **V2 cutout must be specified on training table** (see product notes section for more details and cutout upcharge). **Power Infeed required and sold separate** (see page 563). For multiple circuit configurations, please contact customer service. UL listed and CSA Certified.

- Replace _ with **B** for **Black**
- Replace _ with **S** for **Silver Pearl**
- Villa DaisyLink kits are not recommended for use on 2gether tables or Zira Boardroom Tables

Villa II Power Base

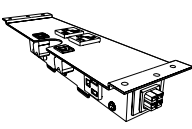

Villa II Flush Lid



Data Knockouts, Data Ports Included

VIF2-41-D_-72SK	--	65	12	.45	\$573
VIF2-41-D_-66SK	--	65	12	.45	\$573
VIF2-41-D_-60SK	--	65	12	.45	\$573
VIF2-41-D_-54K	--	65	12	.45	\$573
VIF2-41-D_-48K	--	65	12	.45	\$573
VIF2-41-D_-42K	--	65	12	.45	\$573
VIF2-41-D_-36K	--	65	12	.45	\$573

42 FF Cable



42 FM Cable



Cable Clamps



Includes **one power block** with **four power receptacles** (two worksurface accessible, two below worksurface) and **two RJ45 Cat 6 Data**, grommet cover, one female/female interconnecting cable, one female/male interconnecting cable and four cable clamps. **V2 cutout must be specified on training table** (see product notes section for more details and cutout upcharge). **Power Infeed required and sold separate** (see page 563). For multiple circuit configurations, please contact customer service. UL listed and CSA Certified.

- Replace _ with **B** for **Black**
- Replace _ with **S** for **Silver Pearl**
- Villa DaisyLink kits are not recommended for use on 2gether tables or Zira Boardroom Tables

Required Specifications

Finish
Power Infeed
Cutout location

T TABLE POWER + TECHNOLOGY SOLUTIONS

VILLA I, LEFT & RIGHT POSITION - DAISYLINK KITS MODEL# DIMENSIONS FREIGHT CLASS WT/LBS. CUBIC FT. LIST PRICE

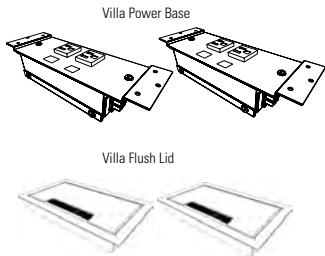

Data Knockouts, No Data Ports

MODEL#	D x W x H	FREIGHT CLASS	WT/LBS.	CUBIC FT.	LIST PRICE
GL-VIF41KO_72DK	--	60	18	.23	\$716
GL-VIF41KO_66DK	--	60	18	.23	\$716
GL-VIF41KO_60DK	--	60	18	.23	\$716

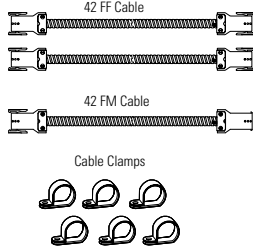

Includes **two power blocks** with **two power receptacles** and two knockouts for data in each block, two grommet covers, two female/female interconnecting cable, one female/male interconnecting cable and 6 cable clamps. **V1 & V3 cutouts must be specified on training table** (see product notes section for more details and cutout upcharge). **Power Infeed required and sold separate** (see page 563). For multiple circuit configurations, please contact customer service. UL listed and CSA Certified.

- Replace _ with **B** for **Black**
- Replace _ with **S** for **Silver Pearl**
- Villa DaisyLink kits are not recommended for use on 2gether tables or Zira Boardroom Tables

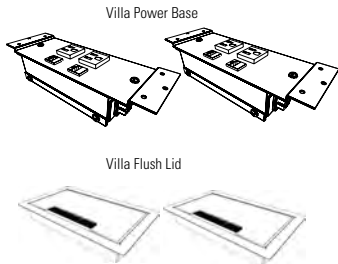

Data Knockouts, Data Ports Included

GL-VIF41D_72DK	--	60	18	.23	\$740
GL-VIF41D_66DK	--	60	18	.23	\$740
GL-VIF41D_60DK	--	60	18	.23	\$740

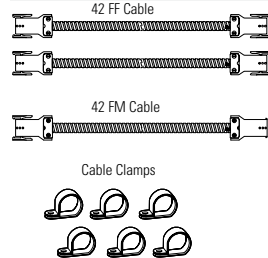

Includes **two power blocks** with **two power receptacles** and **two RJ45 Cat 6** data in each block, two grommet covers, two female/female interconnecting cable, one female/male interconnecting cable and 6 cable clamps. **V1 & V3 cutouts must be specified on training table** (see product notes section for more details and cutout upcharge). **Power Infeed required and sold separate** (see page 563). For multiple circuit configurations, please contact customer service. UL listed and CSA Certified.

- Replace _ with **B** for **Black**
- Replace _ with **S** for **Silver Pearl**
- Villa DaisyLink kits are not recommended for use on 2gether tables or Zira Boardroom tables

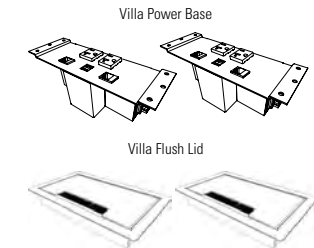

Villa I USB

GL-VIF41UKO_72DK	--	60	23	.23	\$1003
GL-VIF41UKO_66DK	--	60	23	.23	\$1003
GL-VIF41UKO_60DK	--	60	23	.23	\$1003

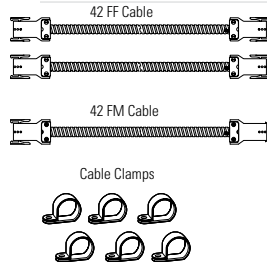

Includes **two power blocks** with **two power receptacles**, **two 2.1 AMP USB charging ports** and two knockouts for data, grommet cover, one female/female interconnecting cable, one female/male interconnecting cable and four cable clamps. **V1 & V3 cutouts must be specified on training table** (see product notes section for more details and cutout upcharge). **Power Infeed required and sold separate** (see page 563). For multiple circuit configurations, please contact customer service. UL listed and CSA Certified.

- Replace _ with **B** for **Black**
- Replace _ with **S** for **Silver Pearl**
- Villa DaisyLink kits are not recommended for use on 2gether tables or Zira Boardroom Tables
- Not compatible with Terina tables or Junction wire managers (JNECxx)

Required Specifications

Finish
Power infeed
Cutout location

VILLA II, LEFT & RIGHT POSITION - DAISYLINK KITS **MODEL#** **DIMENSIONS** **FREIGHT CLASS** **WT/LBS.** **CUBIC FT.** **LIST PRICE**

D x W x H

GLVIF241KO_72DK	--	60	22	.23	\$764
GLVIF241KO_66DK	--	60	22	.23	\$764
GLVIF241KO_60DK	--	60	22	.23	\$764

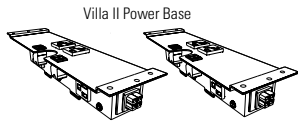

Villa II Power Base



Villa Flush Lid

Data Knockouts, No Data Ports

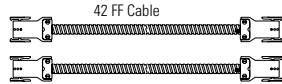

42 FF Cable



42 FM Cable

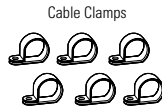

Cable Clamps

Includes **two power blocks** with **four power receptacles** (two worksurface accessible, two below worksurface) and two knockouts for data in each block, two grommet covers, two female/female interconnecting cable, one female/male interconnecting cable and 6 cable clamps. **V1 & V3 cutouts must be specified on training table** (see product notes section for more details and cutout upcharge). **Power Infeed required and sold separate** (see page 563). For multiple circuit configurations, please contact customer service. UL listed and CSA Certified.

- Replace _ with **B** for **Black**
- Replace _ with **S** for **Silver Pearl**
- Villa DaisyLink kits are not recommended for use on 2gether tables or Zira Boardroom Tables

GL-VIF241D_72DK	--	60	22	.23	\$1003
GL-VIF241D_66DK	--	60	22	.23	\$1003
GL-VIF241D_60DK	--	60	22	.23	\$1003

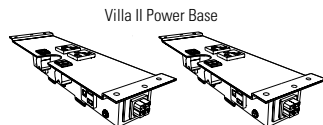

Villa II Power Base

Villa Flush Lid

Data Knockouts, Data Ports Included

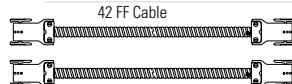

42 FF Cable



42 FM Cable

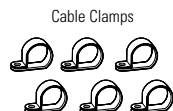

Cable Clamps

Includes **two power blocks** with **four power receptacles** (two worksurface accessible, two below worksurface) and **two RJ45 Cat 6** data in each block, two grommet covers, two female/female interconnecting cable, one female/male interconnecting cable and 6 cable clamps. **V1 & V3 cutouts must be specified on training table** (see product notes section for more details and cutout upcharge). **Power Infeed required and sold separate** (see page 563). For multiple circuit configurations, please contact customer service. UL listed and CSA Certified.

- Replace _ with **B** for **Black**
- Replace _ with **S** for **Silver Pearl**
- Villa DaisyLink kits are not recommended for use on 2gether tables or Zira Boardroom Tables

Required Specifications

- Finish
- Power Infeed
- Cutout location

T TABLE POWER + TECHNOLOGY SOLUTIONS

VILLA I - CORDED UNITS

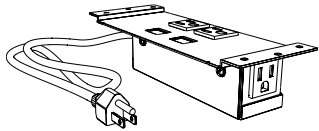

Data Knockouts, No Data Ports

MODEL#	DIMENSIONS D x W x H	FREIGHT CLASS	WT/LBS.	CUBIC FT.	LIST PRICE
VIL-C-DKO-_-108	3.25 x 8.75 x 2.25	100	4	.45	\$192
VIL-C-DKO-_-72	3.25 x 8.75 x 2.25	100	4	.45	\$192

Villa I with 3-prong plug. Includes **two power receptacles** and two knockouts for data. A third convenience receptacle is provided below the worksurface. **V1, V2 or V3 cutout(s) must be specified on training table** (see product notes section for more details and cutout upcharge). **Grommet cover is required and sold separate** (see page 559). UL/CUL listed.

- Replace _ with **B** for **Black**
- Replace _ with **S** for **Silver Pearl**
- -108 models include a 108" long cord. -72 models include a 72" long cord.

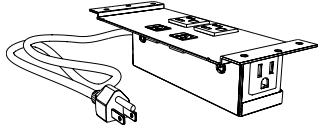

Data Knockouts, Data Ports Included

VIL-C-D-_-108	3.25 x 8.75 x 2.25	100	4	.45	\$311
VIL-C-D-_-72	3.25 x 8.75 x 2.25	100	4	.45	\$311

Villa I with 3-prong plug. Includes **two power receptacles** and **two RJ45 Cat 6** data. A third convenience receptacle is provided below the worksurface. **V1, V2 or V3 cutout(s) must be specified on training table** (see product notes section for more details and cutout upcharge). **Grommet cover is required and sold separate** (see page 559). UL/CUL listed.

- Replace _ with **B** for **Black**
- Replace _ with **S** for **Silver Pearl**

VILLA II - CORDED UNITS

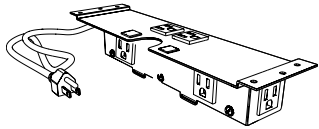

Data Knockouts, No Data Ports

MODEL#	DIMENSIONS	FREIGHT CLASS	WT/LBS.	CUBIC FT.	LIST PRICE
VIL2-C2-DKO_-108	3.25 x 11 x 2.25	85	6	.45	\$263
VIL2-C2-DKO_-72	3.25 x 11 x 2.25	85	6	.45	\$263

Villa II with 3-prong plug. Includes **four power receptacles** (two worksurface accessible, two below worksurface) and two knockouts for data. A fifth convenience receptacle is provided below the worksurface. **V1, V2 or V3 cutout(s) must be specified on training table** (see product notes section for more details and cutout upcharge). **Grommet cover is required and sold separate** (see below). UL/CUL listed.

- Replace _ with **B** for **Black**
- Replace _ with **S** for **Silver Pearl**

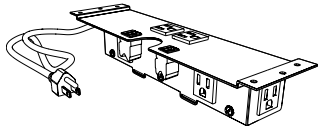

Data Knockouts, Data Ports Included

VIL2-C2-D-_-108	3.25 x 11 x 2.25	85	6	.45	\$383
VIL2-C2-D-_-72	3.25 x 11 x 2.25	85	6	.45	\$383

Villa II with 3-prong plug. Includes **four power receptacles** (two worksurface accessible, two below worksurface) and **two RJ45 Cat 6** data. A fifth convenience receptacle is provided below the worksurface. **V1, V2 or V3 cutout(s) must be specified on training table** (see product notes section for more details and cutout upcharge). **Grommet cover is required and sold separate** (see below). UL/CUL listed.

- Replace _ with **B** for **Black**
- Replace _ with **S** for **Silver Pearl**

Required Specifications

Finish
Power Infeed
Cutout location

VILLA DAISYLINK

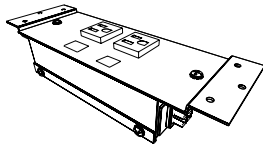

Villa I, DaisyLink

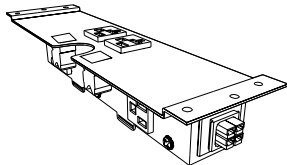

Villa II, DaisyLink

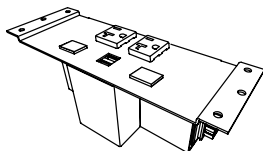

Villa USB, DaisyLink

MODEL#	DIMENSIONS	FREIGHT CLASS	WT/LBS.	CUBIC FT.	LIST PRICE
--------	------------	---------------	---------	-----------	------------

D x W x H

VIL-4-1-DKO-__	--	100	4	.45	\$168
----------------	----	-----	---	-----	--------------

Villa I for use in hardwire or DaisyLink applications. Includes **two power receptacles** and **two knockouts for data in each block**. **V1, V2 or V3 cutout(s) must be specified on table** (see product notes section for more details and cutout upcharge). **Power infeed required and sold separate** (see page 563). *Please see our **Daisy-Chain guide** on page 564 for appropriate cable lengths and important notes.* **Grommet cover is required and sold separate** (see page 559). UL Listed & CSA Certified.

- Replace __ with **B** for **Black**
- Replace __ with **S** for **Silver Pearl**
- Villa DaisyLink kits are not recommended for use on 2gether tables
- Intended for use on Zira Boardroom & Collaborative Tables, Kadin and Swap Tables

VIL2-4-1-DKO-__	--	85	6	.45	\$239
-----------------	----	----	---	-----	--------------

Villa II for use in hardwire or DaisyLink applications. Includes **four power receptacles (two worksurface accessible, two below worksurface)** and **two knockouts for data in each block**. **V1, V2 or V3 cutout(s) must be specified on table** (see product notes section for more details and cutout upcharge). **Power infeed and connecting cables sold separate** (see page 563). *Please see our **Daisy-Chain guide** on page 564 for appropriate cable lengths and important notes.* **Grommet cover is required and sold separate** (see page 559). UL Listed & CSA Certified.

- Replace __ with **B** for **Black**
- Replace __ with **S** for **Silver Pearl**
- Villa DaisyLink kits are not recommended for use on 2gether tables
- Intended for use on Zira Boardroom & Collaborative Tables, Kadin and Swap Tables

VIL-4-1-U-DKO-__	--	85	6	.45	\$311
------------------	----	----	---	-----	--------------

Villa USB for use in hardwire or DaisyLink applications. Includes **two power receptacles, two 2.1 AMB USB charging ports, and two knockouts for data in each block**. **V1, V2 or V3 cutout(s) must be specified on table** (see product notes section for more details and cutout upcharge). **Power infeed and connecting cables sold separate** (see page 563). *Please see our **Daisy-Chain guide** on page 564 for appropriate cable lengths and important notes.* **Grommet cover is required and sold separate** (see page 559). UL Listed & CSA Certified.

- Replace __ with **B** for **Black**
- Replace __ with **S** for **Silver Pearl**
- Villa DaisyLink kits are not recommended for use on 2gether tables
- Not compatible with Terina tables or Junction wire managers (JNECxx)
- Intended for use on Zira Boardroom & Collaborative Tables, Kadin and Swap Tables

VILLA GROMMET COVERS

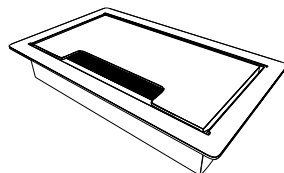

Villa Grommet Cover

MODEL#	DIMENSIONS	FREIGHT CLASS	WT/LBS.	CUBIC FT.	LIST PRICE
--------	------------	---------------	---------	-----------	------------

VIL-GROM-F-__	3.5 x 5.75 x .94	70	1	.08	\$96
---------------	------------------	----	---	-----	-------------

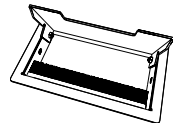

Powder coated flush metal grommet to be used with Villa I and Villa II **corded** series power blocks. Cutouts in tables must be specified separately. **V1, V2 or V3 cutout(s) must be specified on training table** (see product notes section for more details and cutout upcharge). **Grommet cover remains open while in use.**

- **Cannot be used with PMSPDM.**
- Replace __ with **B** for **Black**
- Replace __ with **S** for **Silver Pearl**

Required Specifications

Finish
Power Infeed
Cutout location

T TABLE POWER + TECHNOLOGY SOLUTIONS

VILLA I SERIES CORDED UNITS

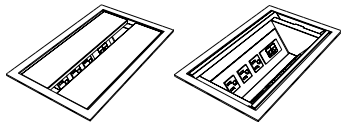

Oasis Mini A, Corded

MODEL#	DIMENSIONS D x W x H	FREIGHT CLASS	WT/LBS.	CUBIC FT.	LIST PRICE
OAM-A-PC-__	15 x 9 x 5.25	92.5	16	1.53	\$1417

Mini Oasis A unit. 15" Trough with six power receptacles, two telecom plate cutouts (**telecom plates sold separate**, see page 562) and two 108" 3-prong plugs. **M1, M2 or M3 cutout(s) must be specified on conference table** (see product notes section for more details and cutout upcharge). UL Listed.

- **Cannot be daisy-chained.**
- Replace _ with **B** for **Black**
- Replace _ with **S** for **Silver Pearl**

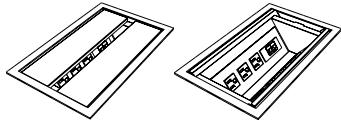

Oasis Mini A, DaisyLink Version

OAM-A-PC-4-1-__	15 x 9 x 5.25	92.5	16	1.53	\$1621
-----------------	---------------	------	----	------	---------------

For hardwire and daisy chain applications. Mini Oasis A unit. 15" Trough with six power receptacles, two telecom plate cutouts (**telecom plates sold separate**, see page 562). **Power infeed sold separate** (see page 563). **M1, M2 or M3 cutout(s) must be specified on conference table** (see product notes section for more details and cutout upcharge). For multiple circuit configurations, please contact customer service. *Please see our **Daisy-Chain guide** on page 564 for appropriate cable lengths and important notes.* UL Listed.

- Replace _ with **B** for **Black**
- Replace _ with **S** for **Silver Pearl**

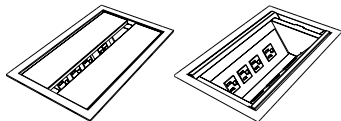

Oasis Mini B, Corded

OAM-B-PC-__	15 x 9 x 5.25	92.5	16	1.53	\$1417
-------------	---------------	------	----	------	---------------

Mini Oasis B unit. 15" Trough with four power receptacles, three telecom plate cutouts (**telecom plates sold separate**, see page 562) and one 108" 3-prong plug. **M1, M2 or M3 cutout(s) must be specified on conference table** (see product notes section for more details and cutout upcharge). UL Listed.

- **Cannot be daisy-chained.**
- Replace _ with **B** for **Black**
- Replace _ with **S** for **Silver Pearl**

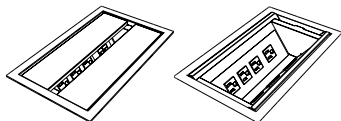

Oasis Mini B, DaisyLink Version

OAM-B-PC-4-1-__	15 x 9 x 5.25	92.5	16	1.53	\$1621
-----------------	---------------	------	----	------	---------------

For hardwire and daisy chain applications. Mini Oasis B unit. 15" Trough with four power receptacles, three telecom plate cutouts (**telecom plates sold separate**, see page 562). **Power infeed sold separate** (see page 563). **M1, M2 or M3 cutout(s) must be specified on conference table** (see product notes section for more details and cutout upcharge). For multiple circuit configurations, please contact customer service. *Please see our **Daisy-Chain guide** on page 564 for appropriate cable lengths and important notes.* UL Listed.

- Replace _ with **B** for **Black**
- Replace _ with **S** for **Silver Pearl**

Required Specifications

Finish
Power Infeed
Cutout location

OASIS MINI

MODEL#	DIMENSIONS	FREIGHT CLASS	WT./LBS.	CUBIC FT.	LIST PRICE
--------	------------	---------------	----------	-----------	------------

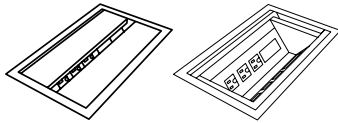

Oasis Mini USB, Corded

	D x W x H				
OAM-U-PC-__	15 x 9 x 5.25	92.5	16	1.53	\$1585

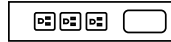
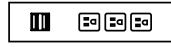

Mini Oasis USB unit. 15" trough with six power receptacles, two 2.1 AMP USB charging ports and one telecom plate cutout (**telecom plates sold separate**, see page 562) and two 108" 3-prong plugs. **M1, M2 or M3 cutout(s) must be specified on conference table** (see product notes section for more details and cutout upcharge). UL Listed.

- **Cannot be daisy-chained.**
- Replace __ with **B** for **Black**
- Replace __ with **S** for **Silver Pearl**

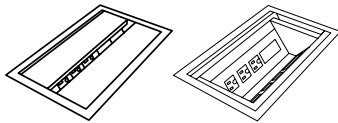

Oasis Mini USB, DaisyLink Version

OAM-U-PC-4-1-__	15 x 9 x 5.25	92.5	16	1.53	\$1790
-----------------	---------------	------	----	------	---------------

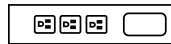
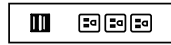

For hardwire and daisy chain applications. Mini Oasis USB unit. 15" trough with six power receptacles, two 2.1 AMP USB charging ports and one telecom plate cutout (**telecom plates sold separate**, see page 562). **Power infeed sold separate** (see page 563). **M1, M2 or M3 cutout(s) must be specified on conference table** (see product notes section for more details and cutout upcharge). For multiple circuit configurations, please contact customer service. *Please see our **Daisy-Chain guide** on page 564 for appropriate cable lengths and important notes.* UL Listed.

- Replace __ with **B** for **Black**
- Replace __ with **S** for **Silver Pearl**

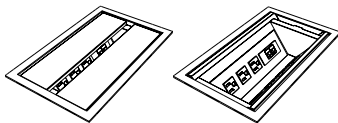

Oasis Mini, Chicago Code

GL-OAMPD_P72HW	15 x 9 x 5.25	92.5	16	1.53	\$1932
----------------	---------------	------	----	------	---------------

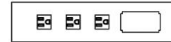

Mini Oasis for Chicago code includes electrical trough with (2) separate hardwire inserts. Each insert includes (3) simplex outlets and (1) telecom plate cutout (**telecom plates sold separate**, see page 562). **M1, M2 or M3 cutout(s) must be specified on conference table** (see product notes section for more details and cutout upcharge). Each component is UL listed.

- **Cannot be daisy-chained.**
- Replace __ with **B** for **Black**
- Replace __ with **S** for **Silver Pearl**

Required Specifications



Finish
Power Infeed
Cutout location

T TABLE POWER + TECHNOLOGY SOLUTIONS

TOP TELECOM PLATES

D x W x H





NOT COMPATIBLE WITH VILLA UNITS

TOP TELECOM PLATE	MODEL	CONFIGURATION	LIST PRICE
	A-__-A-B	Telecom plate with RJ11 Cat 3 Phone and RJ45 Cat 6 Data	\$83
	A-__-B-B	(2) RJ45 Cat 6 Connectors	\$109
	A-__-B-B-B	(3) RJ45 Cat 6 Connectors	\$159
	A-__-B-B-B-B	(4) RJ45 Cat 6 Connectors	\$211
	A-__-B-C51-L	RJ45 Cat 6 Data, Mini-Stereo Inline and 15 pin HD VGA Female/Female with 72" patch cord attached.	\$188
	A-__-B-B-C51	(2) RJ45 Cat 6 Data and (1) 15 pin HD VGA Female/Female with 72" patch cord attached.	\$196
	A-__-A-B-102	RJ11 Cat 3 phone, RJ45 Cat 6 Data and USB with 72" patch cord attached.	\$188
	A-__-B	RJ45 Cat 6 Data	\$57
	A-__-C51-L	Mini Stereo Inline and 15 pin HD VGA Female/Female with 72" patch cord attached.	\$147
	A-__-CRDMINDER	Cordminder Plate - 2 5/8" holes and 1 7/8" holes	\$32
	A-__-C45-C51-L	HDMI Female/Female with 36" patch cord attached. Mini Stereo Inline and 15 Pin HD VGA Female/Female with 72" patch cord attached.	\$257

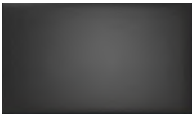

Required Specifications

- Finish
- Power Infeed
- Cutout location

TOP TELECOM PLATES

		D x W x H				
TOP TELECOM PLATE	MODEL	CONFIGURATION				LIST PRICE
	A-__-C45	HDMI Female/Female with 36" patch cord attached.				\$126
	A-__-A-B-B	(1) RJ11 Cat 3 Phone and (2) RJ45 Cat 6 data.				\$137
	A-__	Blank telecom plate				\$7
	A-__-102	USB with 72" patch cord attached.				\$57
	A-__-C51	15 pin HD VGA Female/Female with 72" patch cord attached.				\$94
<ul style="list-style-type: none"> • Replace __ with BL for Black • Replace __ with GR for Grey 						

POWER INFEEDS

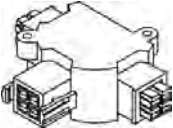
	42AP1-72	--	--	--	--	\$189
Plug and Play Infeed	Single Circuit 20 AMP Power Infeed with 72" 3-prong plug. Provides single power entry from floor or wall mounted standard power supply. Connects to Oasis Mini or Villa units that require a separate infeed. UL Listed.					
	42SB2-108	--	--	--	--	\$156
	42SB2-72	--	--	--	--	\$122
	42SB2-36	--	--	--	--	\$88
Multi-Circuit Hardwire Power Infeed	Multi-Circuit Hardwire Infeed (up to 20 AMPS per circuit), two circuits. Provides single power entry from floor or wall located building power supply. Connects to Oasis Mini or Villa units that require a power infeed. TO BE HARDWIRED BY A LICENSED ELECTRICIAN. UL Listed.					
	DAISY-T	--	70	1	1	\$144
3 Way Power Splitter	Daisy-T power manager includes two male and one female connection. For use in splitting a power source two ways.					

Required Specifications

Finish
Power Infeed
Cutout location

T TABLE POWER + TECHNOLOGY SOLUTIONS

TOP TELECOM PLATES



Interconnecting Cables

D x W x H

42FF-__	Female/Female
42FM-__	Female/Male

UL Listed and CSA Certified. For appropriate quantity and sizes, please refer to the chart on the next page.

Interconnecting Cables - Common Cable Lengths (in inches)

Female/Female	Female/Male
42FF-27\$89	42FM-12\$79
42FF-38\$99	42FM-27\$93
42FF-41\$102	42FM-38\$103
42FF-50\$111	42FM-41\$107
42FF-53\$114	42FM-50\$116
42FF-63\$123	42FM-63\$128
42FF-75\$134	42FM-75\$140
42FF-76\$135	42FM-82\$146
42FF-82\$142	42FM-86\$150
42FF-86\$145	42FM-97\$166
42FF-97\$166	42FM-98\$166
42FF-98\$166	42FM-100\$178
42FF-100\$158	42FM-110\$178
42FF-110\$169	

DRAWING 1A - OASIS MINI A & OASIS MINI USB

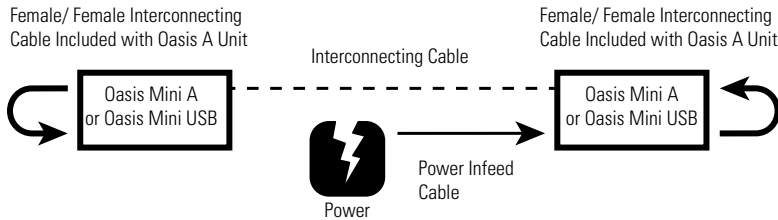

DRAWING 1B - OASIS MINI B

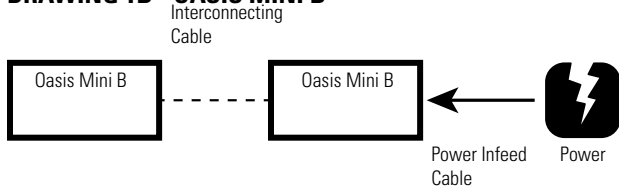

DRAWING 2A - OASIS MINI A & OASIS MINI USB

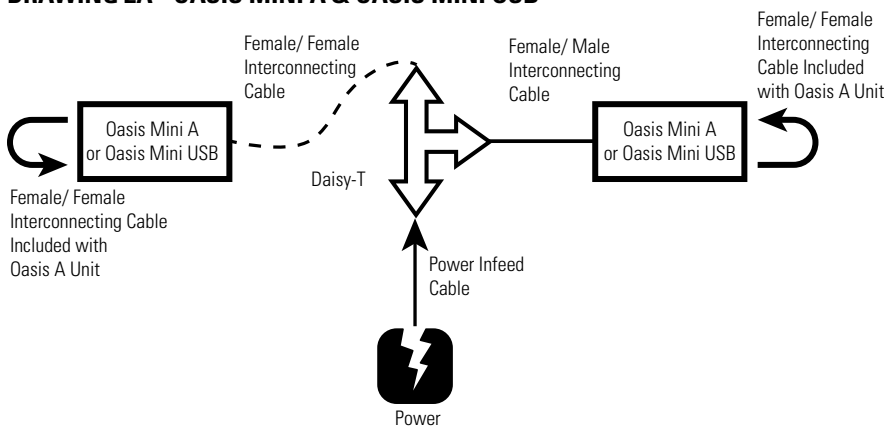

DRAWING 2B - OASIS MINI B

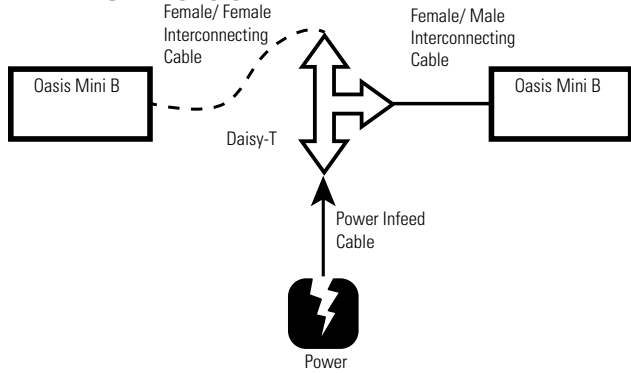

DRAWING 3 - OASIS MINI A & OASIS MINI USB

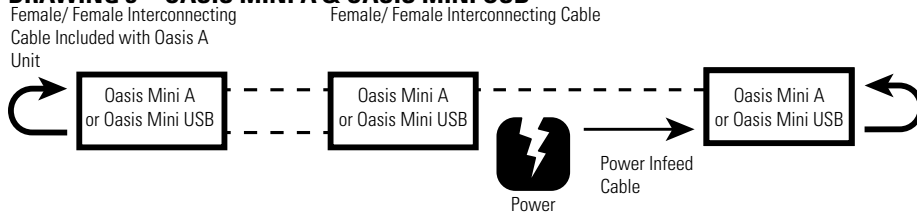

DRAWING 4 - OASIS MINI A & OASIS MINI USB

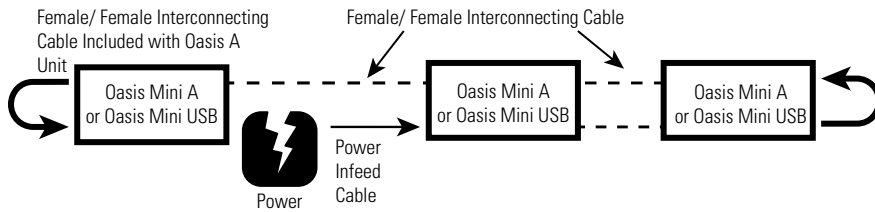

DRAWING 5 - OASIS MINI B

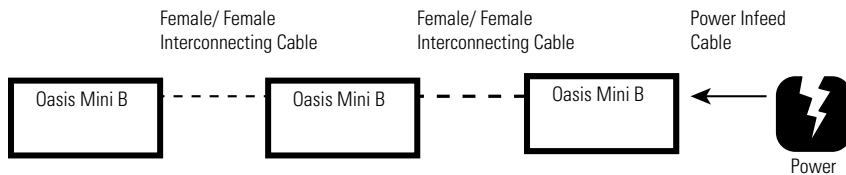

DRAWING 6 - OASIS MINI B

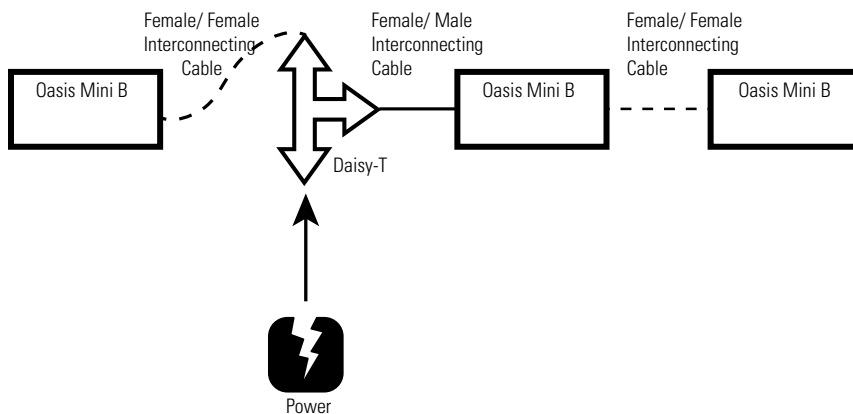
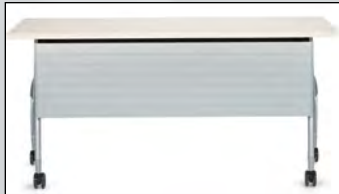

TABLE POWER + TECHNOLOGY SOLUTIONS - NOTES

OASIS MINI A, B & USB CABLE LENGTHS NEEDED FOR DAISY-CHAINING

Model #	Villa DaisyLink, Oasis Mini USB Oasis Mini A Oasis Mini B	Villa DaisyLink, Oasis Mini USB Oasis Mini A Oasis Mini B	Oasis Mini USB Oasis Mini A	Oasis Mini USB Oasis Mini A	Villa DaisyLink or Oasis Mini B	Villa DaisyLink or Oasis Mini B
Cutout Positions	V1, V3, M1, M3	V1, V3, M1, M3	M1, M2 & M3	M1, M2 & M3	V1, V2, V3, M1, M2, M3	V1, V2, V3, M1, M2, M3
Infeed Position	Left or Right	Center	Left or Right	Center	Left or Right	Center
Reference	Drawing 1A/1B	Drawing 2A/2B	Drawing 3	Drawing 4	Drawing 5	Drawing 6
A3672RE A3672RT	N/A	N/A	N/A	N/A	N/A	N/A
A4896RE A4896B A4896RT	(1) 42FF-42 SPECIFY INFEED	(1) 42FF-21 (1) 42FM-21 (1) DAISY-T SPECIFY INFEED	N/A	N/A	N/A	N/A
A48120RE A48120RT	(1) 42FF-64 SPECIFY INFEED	(1) 42FF-32 (1) 42FM-32 (1) DAISY-T SPECIFY INFEED	(3) 42FF-29 SPECIFY INFEED	(3) 42FF-29 SPECIFY INFEED	(2) 42FF-29 SPECIFY INFEED	(2) 42FF-29 (1) 42FM-12 (1) DAISY-T SPECIFY INFEED
A48144B A48144RT	(1) 42FF-92 SPECIFY INFEED	(1) 42FF-46 (1) 42FM-46 (1) DAISY-T SPECIFY INFEED	(3) 42FF-41 SPECIFY INFEED	(3) 42FF-41 SPECIFY INFEED	(2) 41FF-42 SPECIFY INFEED	(2) 42FF-41 (1) 42FM-12 (1) DAISY-T SPECIFY INFEED
Z4896BE Z4896RTE Z4896REE Z4896BW	(1) 42FF-53 SPECIFY INFEED	(1) 42FF-27 (1) 42FM-27 (1) DAISY-T SPECIFY INFEED	N/A	N/A	N/A	N/A
Z48120BE Z48120RTE Z48120REE Z48120BW	(1) 42FF-76 SPECIFY INFEED	(1) 42FF-38 (1) 42FM-38 (1) DAISY-T SPECIFY INFEED	(3) 42FF-41 SPECIFY INFEED	(3) 42FF-41 SPECIFY INFEED	(2) 42FF-41 SPECIFY INFEED	(2) 42FF-41 (1) 42FM-12 (1) DAISY-T SPECIFY INFEED
Z48144BE Z48144RTE Z48144REE Z48144BW	(1) 42FF-100 SPECIFY INFEED	(1) 42FF-50 (1) 42FM-50 (1) DAISY-T SPECIFY INFEED	(3) 42FF-53 SPECIFY INFEED	(3) 42FF-53 SPECIFY INFEED	(2) 42FF-53 SPECIFY INFEED	(2) 42FF-53 (1) 42FM-12 (1) DAISY-T SPECIFY INFEED
Z48168BE Z48168RTE Z48168REE Z48168BW	(1) 42FF-63 (1) 42FM-63 SPECIFY INFEED	(1) 42FF-63 (1) 42FM-63 (1) DAISY-T SPECIFY INFEED	(3) 42FF-65 SPECIFY INFEED	(3) 42FF-65 SPECIFY INFEED	(2) 42FF-65 SPECIFY INFEED	(2) 42FF-65 (1) 42FM-12 (1) DAISY-T SPECIFY INFEED
Z48192BE Z48192RTE Z48192REE Z48192BW	(1) 42FF-75 (1) 42FM-75 SPECIFY INFEED	(1) 42FF-75 (1) 42FM-75 (1) DAISY-T SPECIFY INFEED	(3) 42FF-77 SPECIFY INFEED	(3) 42FF-77 SPECIFY INFEED	(2) 42FF-77 SPECIFY INFEED	(2) 42FF-77 (1) 42FM-12 (1) DAISY-T SPECIFY INFEED
Z48216BE Z48216RTE Z48216REE Z48216BW	(1) 42FF-86 (1) 42FM-86 SPECIFY INFEED	(1) 42FF-85 (1) 42FM-85 (1) DAISY-T SPECIFY INFEED	(3) 42FF-89 SPECIFY INFEED	(3) 42FF-89 SPECIFY INFEED	(2) 42FF-89 SPECIFY INFEED	(2) 42FF-89 (1) 42FM-12 (1) DAISY-T SPECIFY INFEED
Z48240BE Z48240RTE Z48240REE Z48240BW	(1) 42FF-98 (1) 42FM-98 SPECIFY INFEED	(1) 42FF-97 (1) 42FM-97 (1) DAISY-T SPECIFY INFEED	(3) 42FF-101 SPECIFY INFEED	(3) 42FF-101 SPECIFY INFEED	(2) 42FF-101 SPECIFY INFEED	(2) 42FF-101 (1) 42FM-12 (1) DAISY-T SPECIFY INFEED
Z48264BE Z48264RTE Z48264REE Z48264BW	(1) 42FF-110 (1) 42FM-110 SPECIFY INFEED	(1) 42FF-110 (1) 42FM-110 (1) DAISY-T SPECIFY INFEED	(3) 42FF-113 SPECIFY INFEED	(3) 42FF-113 SPECIFY INFEED	(2) 42FF-113 SPECIFY INFEED	(2) 42FF-113 (1) 42FM-12 (1) DAISY-T SPECIFY INFEED
Z48288BE Z48288RTE Z48288REE Z48288BW	(1) 42FF-82 (2) 42FM-82 SPECIFY INFEED	(2) 42FF-41 (2) 42FM-41 (1) DAISY-T SPECIFY INFEED	(3) 42FF-63 (3) 42FM-63 SPECIFY INFEED	(3) 42FF-63 (3) 42FM-63 SPECIFY INFEED	(2) 42FF-63 (2) 42FM-63 SPECIFY INFEED	(2) 42FF-63 (2) 42FM-63 (1) DAISY-T SPECIFY INFEED

tables and accessories



2gether

568



Alba

570



Boardroom

582



Bungee/Bungee SL

603



Citi Tables

716



ConnectTABLES

634



Dawson

718



Duet Tables

650



Junction

673



Kadin

680

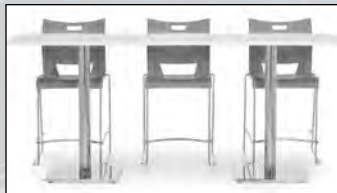

Swap Tables

689



Zook

716

global

GENERAL INFORMATION

- 2gether is a series of multi-purpose flip-top tables for collaboration, classroom, training and conference applications.
- “Easy Touch” mechanism allows you to flip the tables up or down with maximum ease
- Adjustable leveling casters provide smooth mobility
- Offset “Y” sculpted legs allow for parallel space-saving table nesting, to minimize footprint required for storage
- Optional modesty panels with integrated wire troughs are available
- Grommets are available on 24” deep worksurfaces
- Available sizes: 18”D x 60”W, 24”D x 60”W and 72”W
- Shipped easy to assemble. Each component is packaged individually; legs are shipped 1 per carton.
- For environmental certifications, please visit globalfurnituregroup.com

WORKSURFACES

- 1” thick tops are constructed of 45 lb. density particleboard with high performance thermally fused laminate

CONSTRUCTION

- “Easy touch” lever located at both sides of table for flip-top operation from either side
- Global’s preferred matching edge
- Tops are pre-drilled with threaded steel inserts
- Tops 60” and 72” wide feature a built-in support bar
- 14.25” high optional articulating modesty panel attaches to underside of flip-top
- Bumpers on legs and undercarriage prevent tables from being damaged while nested
- Grommets optional on 24” deep tops only
- Champagne base finish
- Products specified with the high pressure laminate option are finished on the underside of the surface with a kraft paper backing.

LAMINATE FINISHES

ACJ	Absolute Acajou	HGT	Hayden Grey
ASN	Asian Night	QTM	Quartered Mahogany
AWC	Avant Cherry	SOG	Storm Grey
AWH	Avant Honey	TFW	Tiger Fruitwood
BLK	Black	TWL	Tiger Walnut
BRC	Brushed Cobalt	WHE	Walnut Heights
CMB	Clear Maple	WHC	White Chocolate
DES	Dark Espresso	WCR	Winter Cherry
DWT	Designer White	WGY	Willow Grey

GROMMETS

- Available only on 24” deep worksurfaces
- Additional grommets available in standard worksurface locations (left, center or right). Order as: **AG1, AG2 or AG3. Add \$69**
- Grommet hole dimensions are 3 ¼” wide x 1 7/8” deep.

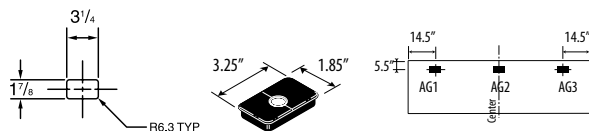

- Grommets may be placed at non-standard locations. Order as: **AGS - Add \$69** A drawing must be supplied with vertical and horizontal dimensions to the center of the cut-out (as in drawing above). Please refer to CUSTOM GROMMET LOCATION FORM in the back reference section.

POWER BLOCK

- Available only on 24” deep worksurfaces
- A Power Block is a rectangular worksurface power/data module with one electrical duplex receptacle and two data (RJ45) receptacles. 9’ black cord included. Power Block dimensions are 3 ½” deep x 6 ½” wide x 2 ¾” high.
- A Power Block (model **PMSPPDM**) may be ordered for **24” Deep Tables** in place of standard grommets.
- To purchase a Power Block, you must specify both the Power Block cut-out location and the Power Block model #. Order Power Block as **PMSPPDM, Add \$261**. Power Blocks are available in standard worksurface locations (left, center or right). Order as **E1, E2 or E3. Add \$69**.

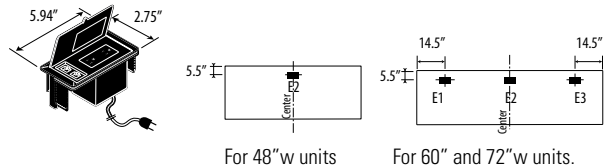

Power Block **PMSPPDM, Add \$261** Specify location **E1, E2 or E3, Add \$69**

VILLA CUTOUTS

- Available only on 24” deep worksurfaces
- A Villa Power Block is available in kits for daisy-chaining, or corded for use on individual tables (see page 545 for Villa details). Villa Power Block dimensions vary by model. Villa cutout dimensions are 3” deep x 5 ¼” wide
- A Villa cutout may be ordered for 24” Deep Tables. Order as **V1, V2 or V3, Add \$69 for each cutout**.
- Order Villa Power Block and Villa Grommet Cover separately, see page 545 for pricing and details

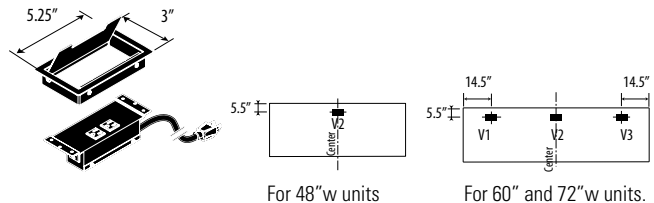

SHIPPING

- Items are shipped R.T.A. (Ready To Assemble)
- Easy to assemble with screwdriver
- Each top is packaged and shipped individually
- “Y” legs are packaged and shipped in one carton
- Table base is packaged and shipped in one carton

RECTANGULAR TOP

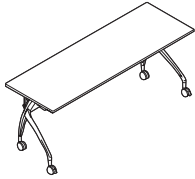

Rectangular Table - Flip-Top

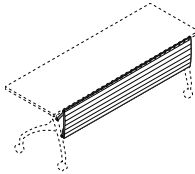

Modesty Panel

MODEL#	DIMENSIONS	FREIGHT CLASS	WT/LBS.	CUBIC FT.	LIST PRICE	HP ADD
--------	------------	---------------	---------	-----------	------------	--------

D x W x H						
IT2472RX	24 x 72 x 29	92.5	97.20	8.68	\$1637	\$213
IT2460RX	24 x 60 x 29	92.5	86	7.68	\$1531	\$189
IT1860RX	18 x 60 x 29	92.5	75	6.98	\$1473	\$166

Easy touch flip-top table on 4 adjustable leveling casters, 2 locking. Easy touch lever located at both ends of the table allows for activation on either side of the table; offset Y leg accommodates in-line nesting for space-saving storage. Wire management channel included. Champagne finish leg, black casters. Optional articulating modesty panel available.

IT72MP	2.75 x 63 x 14.25	125	13.20	2	\$238	
IT60MP	2.75 x 51 x 14.25	125	11.40	1.60	\$219	
IT48MP	2.75 x 39 x 14.25	125	9.70	1.30	\$200	

Articulating modesty for use with flip-top 2gether tables. Champagne finish.

Required Specifications

Top Finish

Accessories

Modesty Panel



Contemporary and stylish meeting tables with unique METAL bases. Offers a variety of options to suit the needs of any office.

Tops are available in your choice of six shapes - Round, Square, Rectangular, Boat Shaped, Racetrack and Elliptical.

Two different metal base styles - Sculpted and Four-Legged. Round and Square tops are available exclusively with the four-legged base, while all other tops are available in Sculpted base style.

Five edge options - Self, Bullnose, T-Mold, Built Up and the Slant edge. Slant Edge and Metal Base finishes are available in either Black or Tungsten.

No matter the size of the space or the style of the office, Global's Laminate Meeting tables will work in any setting.

Designed exclusively for Global by world renowned designer Zooey Chu.



Features and Benefits

- Tables 144" or less are standard in one piece
- All tops over 144" are standard in two pieces
- One-piece tops can be cut to 2 pieces for an upcharge
- All tops and bases are assembled using a metal-to-metal connection
- All tops are 1 1/8" thick - a 1 3/4" built-up self edge is available on all models
- Tops and bases boxed as appropriate
- Custom finish laminate tables available as special order
- Bullnose edge available in Black or Grey
- T-Mold edge available in Black, Grey or coordinating laminate finish.
- Self-edge and built-up self edge available in same color as laminate finish.
- Slant edge is available in Black or Tungsten
- All edges available on all tables
- All Metal bases are available in Black and Tungsten

GENERAL INFORMATION

- Designed by Zooney Chu
- Five edge options: Self, Bullnose, T-Mold, Built-Up and Slant edge.
- Two different metal base styles - Sculpted and Four-Legged
- Global laminate and seating products are in compliance with stringent emission guidelines set out by the Greenguard Environmental Institute under the standards for low emitting products and materials. www.greenguard.org
- **Level 2 Certified**

CONSTRUCTION

- All laminate meeting tables are 28.5" high and made of 45 lb. density particle board covered on both sides with high performance, thermally fused laminate. Table width is nominal.
- All tops are 1-1/8" thick with high performance, thermally fused laminate on both sides. A 1 3/4" built-up self edge is available on all models.
- Tops are crated and bases boxed or crated as appropriate
- Table tops of 144" or less in length are standard as one piece. One piece tops can be cut to 2 piece tops. **Add \$224.**
- All Tops and Bases use a metal to metal connection, allowing for easy installation.
- Custom size tables are priced at next size table price, not to exceed width or length. Example: 44" x 108" would be priced at the 48" x 120" price. Contact Customer Service for pricing of tables over 48" in width. Custom tables less than the smallest size must be quoted.
- Products specified with the high pressure laminate option are finished on the underside of the surface with a kraft paper backing.

EDGE OPTIONS

- Self, built-up, bullnose, T-mold and slant edges are available on all models. Corners of rectangular, square and boat shaped tables ordered with T-mold or bullnose will be rounded.
- **Bullnose** edge is available in Black (**BK**) or Grey (**GR**) only.
- **T-mold** edge is available in Black (**BK**), Grey (**GR**), or coordinating laminate finish (**ME**)
- **Slant** edge is available in Black (**BLK**) or Tungsten (**TUN**).
- **Self edge and built-up** edges are same color as laminate finish.

LAMINATE FINISHES

ACJ	Absolute Acajou	HGT	Hayden Grey
ASN	Asian Night	QTM	Quartered Mahogany
AWC	Avant Cherry	SOG	Storm Grey
AWH	Avant Honey	TFW	Tiger Fruitwood
BLK	Black	TWL	Tiger Walnut
BRC	Brushed Cobalt	WHE	Walnut Heights
CMB	Clear Maple	WHC	White Chocolate
DES	Dark Espresso	WCR	Winter Cherry
DWT	Designer White	WGY	Willow Grey

- White Chocolate (**WHC**) not available on 10 & 12 foot tables. Must be cut in two pieces.
- The above laminate finishes are available in **High Pressure**. Upcharge varies by model.
- Tables in woodgrain finishes over 12' in length will not have a perfect match of grain at the center where the two halves meet.
- If other than a Global standard laminate finish is preferred, contact Customer Care. Information needed includes the name of the laminate manufacturer, color name, number and model of table. You will then be given a quote for this special order.

BASE SIZE CHART (Table width is nominal)

Round or Square Tops		Rectangular, Racetrack, Boat or Elliptical Tops	
Top	4 Leg	Top	Sculpted
30"	25"	30" x 60"	24"
36"	25"	44" x 84"	30"
42"	32"	36" x 72"	24"
48"	32"	48" x 96"	30"
		48" x 120"	30"
		48" x 144"	30"

SCULPTED BASE

- Sculpted bases on tables 7' and larger include support braces for maximum strength. Not included on 5' and 6' tables. Bases are available in Black (**BLK**) or Tungsten (**TUN**) finish only.

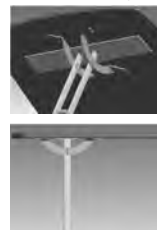
**GROMMETS**

- Grommets available in standard table top locations (left, center or right). Order as: **AG1, AG2 or AG3. Add \$69.**
- Grommet hole dimensions are 3 1/4" wide x 1 7/8" deep.

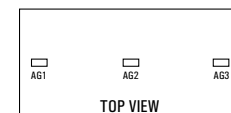
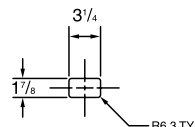

- Actual grommet locations will vary according to base selection.

POWER BLOCK

- A Power Block (model **PMSPPDM**) may be ordered on all worksurfaces.
- A Power Block is a rectangular worksurface power/data module with one electrical duplex receptacle and two data (RJ45) receptacles. 9' black cord included. Power Block dimensions are 3 1/2" deep x 6 1/2" wide x 2 3/4" high.
- Actual Power Block locations vary according to base selection. The locations will be left (AG1, E1), center (AG2, E2), and right (AG3, E3).
- To purchase a Power Block, you must specify both the Power Block cut-out location and the Power Block model #. Order Power Block as **PMSPPDM, Add \$261.** Power Blocks are available in standard worksurface locations (left, center or right). Order as **E1, E2 or E3. Add \$69.**

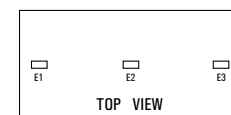

Power Block **PMSPPDM, Add \$261** Specify location **E1, E2 or E3, Add \$69**

TABLE NOTES - ESTIMATED CAPACITY

- Use the following for determining the size of a round table and the number of chairs needed for a conference area. All estimates are based on an average chair width of 23" with a 4" clearance between chairs. Adjust accordingly for a different chair size.

Top Size	Round	Square	Rectangular	Boat	Racetrack	Elliptical
30x30	3	3	N/A	N/A	N/A	N/A
36x36	4	4	N/A	N/A	N/A	N/A
42x42	4	4	N/A	N/A	N/A	N/A
48x48	4	4	N/A	N/A	N/A	N/A
60x60	5	6	N/A	N/A	N/A	N/A
30x60	N/A	N/A	4-6	4-6	4-6	4
36x72	N/A	N/A	4-6	4-6	4-6	4
44x84	N/A	N/A	6-8	6-8	6-8	6
48x96	N/A	N/A	6-8	6-8	6-8	6
48x120	N/A	N/A	8-10	8-10	8-10	8
48x144	N/A	N/A	10-12	10-12	10-12	10
48x168	N/A	N/A	12-14	12-14	12-14	12
48x192	N/A	N/A	14-16	14-16	14-16	14
48x216	N/A	N/A	16-18	16-18	16-18	16
48x240	N/A	N/A	18-20	18-20	18-20	18
48x264	N/A	N/A	20-22	20-22	20-22	20
48x288	N/A	N/A	22-24	22-24	22-24	22

ROUND TOP - FOUR LEGGED BASE

	MODEL#	DIMENSIONS D x W x H	FREIGHT CLASS	WT/LBS.	CUBIC FT.	LIST PRICE	HP ADD
self edge	GC30CF	30 x 30 x 28.5	125	54.50	7.06	\$574	\$287
bullnose edge	GC30CFBN	30 x 30 x 28.5	125	54.50	7.06	\$574	\$287
T-mold edge	GC30CFM	30 x 30 x 28.5	125	54.50	7.06	\$574	\$287
built-up self edge	GC30CFBU	30 x 30 x 28.5	125	59.50	7.82	\$667	\$333.50
slant edge	GC30CFZS	30 x 30 x 28.5	125	54.50	7.06	\$574	\$287
self edge	GC36CF	36 x 36 x 28.5	100	72.50	7.50	\$623	\$311.50
bullnose edge	GC36CFBN	36 x 36 x 28.5	100	72.50	7.50	\$623	\$311.50
T-mold edge	GC36CFM	36 x 36 x 28.5	100	72.50	7.50	\$623	\$311.50
built-up self edge	GC36CFBU	36 x 36 x 28.5	100	79.50	8.44	\$714	\$357
slant edge	GC36CFZS	36 x 36 x 28.5	100	72.50	7.50	\$623	\$311.50
self edge	GC42CF	42 x 42 x 28.5	125	83.29	11.12	\$732	\$366
bullnose edge	GC42CFBN	42 x 42 x 28.5	125	83.29	11.12	\$732	\$366
T-mold edge	GC42CFM	42 x 42 x 28.5	125	83.29	11.12	\$732	\$366
built-up self edge	GC42CFBU	42 x 42 x 28.5	125	92.10	12.40	\$824	\$412
slant edge	GC42CFZS	42 x 42 x 28.5	125	83.29	11.12	\$732	\$366
self edge	GC48CF	48 x 48 x 28.5	100	98.29	11.72	\$823	\$411.50
bullnose edge	GC48CFBN	48 x 48 x 28.5	100	98.29	11.72	\$823	\$411.50
T-mold edge	GC48CFM	48 x 48 x 28.5	100	98.29	11.72	\$823	\$411.50
built-up self edge	GC48CFBU	48 x 48 x 28.5	100	109	13.38	\$916	\$458
slant edge	GC48CFZS	48 x 48 x 28.5	100	98.29	11.72	\$823	\$411.50

SQUARE TOP - FOUR LEGGED BASE

self edge	GC30SF	30 x 30 x 28.5	125	54.50	7.06	\$574	\$287
bullnose edge	GC30SFBN	30 x 30 x 28.5	125	54.50	7.06	\$574	\$287
T-mold edge	GC30SFM	30 x 30 x 28.5	125	54.50	7.06	\$574	\$287
built-up self edge	GC30SFBU	30 x 30 x 28.5	125	59.50	7.82	\$667	\$333.50
slant edge	GC30SFZS	30 x 30 x 28.5	125	54.50	7.06	\$574	\$287
self edge	GC36SF	36 x 36 x 28.5	100	72.50	7.50	\$623	\$311.50
bullnose edge	GC36SFBN	36 x 36 x 28.5	100	72.50	7.50	\$623	\$311.50
T-mold edge	GC36SFM	36 x 36 x 28.5	100	72.50	7.50	\$623	\$311.50
built-up self edge	GC36SFBU	36 x 36 x 28.5	100	79.50	8.44	\$714	\$357
slant edge	GC36SFZS	36 x 36 x 28.5	100	72.50	7.50	\$623	\$311.50
self edge	GC42SF	42 x 42 x 28.5	125	83.29	11.12	\$732	\$366
bullnose edge	GC42SFBN	42 x 42 x 28.5	125	83.29	11.12	\$732	\$366
T-mold edge	GC42SFM	42 x 42 x 28.5	125	83.29	11.12	\$732	\$366
built-up self edge	GC42SFBU	42 x 42 x 28.5	125	92.10	12.40	\$824	\$412
slant edge	GC42SFZS	42 x 42 x 28.5	125	83.29	11.12	\$732	\$366
self edge	GC48SF	48 x 48 x 28.5	100	98.29	11.72	\$823	\$411.50
bullnose edge	GC48SFBN	48 x 48 x 28.5	100	98.29	11.72	\$823	\$411.50
T-mold edge	GC48SFM	48 x 48 x 28.5	100	98.29	11.72	\$823	\$411.50
built-up self edge	GC48SFBU	48 x 48 x 28.5	100	109	13.38	\$916	\$458
slant edge	GC48SFZS	48 x 48 x 28.5	100	98.29	11.72	\$823	\$411.50

Required Specifications

Finish
Base Finish
Edge Color, if applicable

RECTANGULAR TOP - SCULPTED BASE

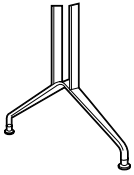
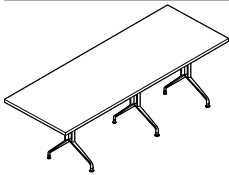

Sculpted Base

		MODEL#	DIMENSIONS	FREIGHT CLASS	WT/LBS.	CUBIC FT.	LIST PRICE	HP ADD
			D x W x H					
5 foot	self edge	GR5S	30 x 60 x 28.5	150	91.40	17.96	\$976	\$488
	bullnose edge	GR5SBN	30 x 60 x 28.5	150	91.40	17.96	\$976	\$488
	T-mold edge	GR5STM	30 x 60 x 28.5	150	91.40	17.96	\$976	\$488
	built-up self edge	GR5SBU	30 x 60 x 28.5	150	91.40	17.96	\$1130	\$565
	slant edge	GR5SZS	30 x 60 x 28.5	150	91.40	17.96	\$976	\$488
• ships in one piece								
6 foot	self edge	GR6S	36 x 72 x 28.5	150	109.40	22.40	\$1069	\$534.50
	bullnose edge	GR6SBN	36 x 72 x 28.5	150	109.40	22.40	\$1069	\$534.50
	T-mold edge	GR6STM	36 x 72 x 28.5	150	109.40	22.40	\$1069	\$534.50
	built-up self edge	GR6SBU	36 x 72 x 28.5	150	118.40	22.40	\$1221	\$610.50
	slant edge	GR6SZS	36 x 72 x 28.5	150	109.40	22.40	\$1069	\$534.50
• ships in one piece								
7 foot	self edge	GR7S	44 x 84 x 28.5	250	103.04	33.77	\$1224	\$612
	bullnose edge	GR7SBN	44 x 84 x 28.5	250	103.04	33.77	\$1224	\$612
	T-mold edge	GR7STM	44 x 84 x 28.5	250	103.04	33.77	\$1224	\$612
	built-up self edge	GR7SBU	44 x 84 x 28.5	250	115.29	33.77	\$1377	\$688.50
	slant edge	GR7SZS	44 x 84 x 28.5	250	103.04	33.77	\$1224	\$612
• ships in one piece								
8 foot	self edge	GR8WS	48 x 96 x 28.5	250	149.40	38.29	\$1224	\$612
	bullnose edge	GR8WSBN	48 x 96 x 28.5	250	149.40	38.29	\$1224	\$612
	T-mold edge	GR8WSTM	48 x 96 x 28.5	250	149.40	38.29	\$1224	\$612
	built-up self edge	GR8WSBU	48 x 96 x 28.5	150	165.40	38.29	\$1377	\$688.50
	slant edge	GR8WSZS	48 x 96 x 28.5	250	149.40	38.29	\$1224	\$612
• ships in one piece								
10 foot	self edge	GR10WS	48 x 120 x 28.5	70	256.10	15.80	\$1712	\$856
	bullnose edge	GR10WSBN	48 x 120 x 28.5	70	256.10	15.80	\$1712	\$856
	T-mold edge	GR10WSTM	48 x 120 x 28.5	70	256.10	15.80	\$1712	\$856
	built-up self edge	GR10WSBU	48 x 120 x 28.5	70	276.10	15.80	\$1866	\$933
	slant edge	GR10WSZS	48 x 120 x 28.5	70	256.10	15.80	\$1712	\$856
• ships in one piece								
12 foot	self edge	GR12WS	48 x 144 x 28.5	85	281.10	18.80	\$1897	\$948.50
	bullnose edge	GR12WSBN	48 x 144 x 28.5	85	281.10	18.80	\$1897	\$948.50
	T-mold edge	GR12WSTM	48 x 144 x 28.5	85	281.10	18.80	\$1897	\$948.50
	built-up self edge	GR12WSBU	48 x 144 x 28.5	70	305.10	18.80	\$2048	\$1024
	slant edge	GR12WSZS	48 x 144 x 28.5	85	281.10	18.80	\$1897	\$948.50
• ships in one piece								
14 foot	self edge	GR14WS	48 x 168 x 28.5	100	164.25	20.05	\$2559	\$1279.50
	bullnose edge	GR14WSBN	48 x 168 x 28.5	100	164.25	20.05	\$2559	\$1279.50
	T-mold edge	GR14WSTM	48 x 168 x 28.5	100	164.25	20.05	\$2559	\$1279.50
	built-up self edge	GR14WSBU	48 x 168 x 28.5	100	188.30	20.05	\$2774	\$1387
	slant edge	GR14WSZS	48 x 168 x 28.5	100	164.25	20.05	\$2559	\$1279.50
• ships in two pieces								
16 foot	self edge	GR16WS	48 x 192 x 28.5	92.5	257.18	23.05	\$2559	\$1279.50
	bullnose edge	GR16WSBN	48 x 192 x 28.5	92.5	257.18	23.05	\$2559	\$1279.50
	T-mold edge	GR16WSTM	48 x 192 x 28.5	92.5	257.18	23.05	\$2559	\$1279.50
	built-up self edge	GR16WSBU	48 x 192 x 28.5	85	285.20	23.05	\$2774	\$1387
	slant edge	GR16WSZS	48 x 192 x 28.5	92.5	257.18	23.05	\$2559	\$1279.50
• ships in two pieces								

Required Specifications

Finish
Base Finish
Edge Color, if applicable

Optional Specifications

Grommet

Accessories

Power Block

RECTANGULAR TOP - SCULPTED BASE

	MODEL#	DIMENSIONS	FREIGHT CLASS	WT/LBS.	CUBIC FT.	LIST PRICE	HP ADD
		D x W x H					
18 foot	self edge	GR18WS	48 x 216 x 28.5	85	390	26.10	\$3089 \$1544.50
	bullnose edge	GR18WSBN	48 x 216 x 28.5	85	390	26.10	\$3089 \$1544.50
	T-mold edge	GR18WSTM	48 x 216 x 28.5	85	390	26.10	\$3089 \$1544.50
	built-up self edge	GR18WSBU	48 x 216 x 28.5	85	390	26.10	\$3305 \$1652.50
	slant edge	GR18WSZS	48 x 216 x 28.5	85	390	26.10	\$3089 \$1544.50
	• ships in two pieces						
20 foot	self edge	GR20WS	48 x 240 x 28.5	250	492.20	189.2	\$3518 \$1759
	bullnose edge	GR20WSBN	48 x 240 x 28.5	250	492.20	189.2	\$3518 \$1759
	T-mold edge	GR20WSTM	48 x 240 x 28.5	250	492.20	189.2	\$3518 \$1759
	built-up self edge	GR20WSBU	48 x 240 x 28.5	250	532.20	189.2	\$3733 \$1866.50
	slant edge	GR20WSZS	48 x 240 x 28.5	250	492.20	189.2	\$3518 \$1759
	• ships in two pieces						
22 foot	self edge	GR22WS	48 x 264 x 28.5	250	509.50	204.3	\$3945 \$1972.50
	bullnose edge	GR22WSBN	48 x 264 x 28.5	250	509.50	204.3	\$3945 \$1972.50
	T-mold edge	GR22WSTM	48 x 264 x 28.5	250	509.50	204.3	\$3945 \$1972.50
	built-up self edge	GR22WSBU	48 x 264 x 28.5	250	553.50	204.3	\$4159 \$2079.50
	slant edge	GR22WSZS	48 x 264 x 28.5	250	509.50	204.3	\$3945 \$1972.50
	• ships in two pieces						
24 foot	self edge	GR24WS	48 x 288 x 28.5	250	542.20	225.2	\$4384 \$2192
	bullnose edge	GR24WSBN	48 x 288 x 28.5	250	542.20	225.2	\$4384 \$2192
	T-mold edge	GR24WSTM	48 x 288 x 28.5	250	542.20	225.2	\$4384 \$2192
	built-up self edge	GR24WSBU	48 x 288 x 28.5	250	590.20	225.2	\$4598 \$2299
	slant edge	GR24WSZS	48 x 288 x 28.5	250	542.20	225.2	\$4384 \$2192
	• ships in two pieces						

- All tops over 144" are standard in two pieces. Woodgrain laminate finishes will NOT align where the two tops join.
- All tops 120", 144", 168" and 192" are SHIPPED WITH 3 SCULPTED BASES.
- All tops 216" and 240" are SHIPPED WITH 4 SCULPTED BASES.
- All tops 264" and 288" are SHIPPED WITH 5 SCULPTED BASES.

Required Specifications

Finish
Base Finish
Edge Color, if applicable



Optional Specifications

Grommet

Accessories

Power Block

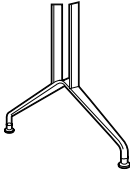
RACETRACK TOP - SCULPTED BASE

		MODEL#	DIMENSIONS	FREIGHT CLASS	WT/LBS.	CUBIC FT.	LIST PRICE	HP ADD	
		D x W x H							
	5 foot	self edge	GRT5S	30 x 60 x 28.5	150	91.40	17.96	\$976	\$488
		bullnose edge	GRT5SBN	30 x 60 x 28.5	150	91.40	17.96	\$976	\$488
		T-mold edge	GRT5STM	30 x 60 x 28.5	150	91.40	17.96	\$976	\$488
		built-up self edge	GRT5SBU	30 x 60 x 28.5	250	91.40	24	\$1130	\$565
		slant edge	GRT5SZS	30 x 60 x 28.5	150	91.40	17.96	\$976	\$488
		• ships in one piece							
	6 foot	self edge	GRT6S	36 x 72 x 28.5	150	99.40	22.40	\$1069	\$534.50
		bullnose edge	GRT6SBN	36 x 72 x 28.5	150	99.40	22.40	\$1069	\$534.50
		T-mold edge	GRT6STM	36 x 72 x 28.5	150	99.40	22.40	\$1069	\$534.50
		built-up self edge	GRT6SBU	36 x 72 x 28.5	150	108.40	22.40	\$1221	\$610.50
		slant edge	GRT6SZS	36 x 72 x 28.5	150	99.40	22.40	\$1069	\$534.50
		• ships in one piece							
 <p>Sculpted Base</p>	7 foot	self edge	GRT7S	44 x 84 x 28.5	250	93.40	33.77	\$1224	\$612
		bullnose edge	GRT7SBN	44 x 84 x 28.5	250	93.40	33.77	\$1224	\$612
		T-mold edge	GRT7STM	44 x 84 x 28.5	250	93.40	33.77	\$1224	\$612
		built-up self edge	GRT7SBU	44 x 84 x 28.5	250	116.65	33.77	\$1377	\$688.50
		slant edge	GRT7SZS	44 x 84 x 28.5	250	93.40	33.77	\$1224	\$612
		• ships in one piece							
	8 foot	self edge	GRT8WS	48 x 96 x 28.5	250	139.40	38.29	\$1224	\$612
		bullnose edge	GRT8WSBN	48 x 96 x 28.5	250	139.40	38.29	\$1224	\$612
		T-mold edge	GRT8WSTM	48 x 96 x 28.5	250	139.40	38.29	\$1224	\$612
		built-up self edge	GRT8WSBU	48 x 96 x 28.5	250	151.40	38.29	\$1377	\$688.50
		slant edge	GRT8WSZS	48 x 96 x 28.5	250	139.40	38.29	\$1224	\$612
		• ships in one piece							
	10 foot	self edge	GRT10WS	48 x 120 x 28.5	70	246.10	15.80	\$1712	\$856
		bullnose edge	GRT10WSBN	48 x 120 x 28.5	70	246.10	15.80	\$1712	\$856
		T-mold edge	GRT10WSTM	48 x 120 x 28.5	70	246.10	15.80	\$1712	\$856
		built-up self edge	GRT10WSBU	48 x 120 x 28.5	70	266.10	15.80	\$1866	\$933
		slant edge	GRT10WSZS	48 x 120 x 28.5	70	246.10	15.80	\$1712	\$856
		• ships in one piece							
	12 foot	self edge	GRT12WS	48 x 144 x 28.5	85	271.10	18.80	\$1897	\$948.50
		bullnose edge	GRT12WSBN	48 x 144 x 28.5	85	271.10	18.80	\$1897	\$948.50
		T-mold edge	GRT12WSTM	48 x 144 x 28.5	85	271.10	18.80	\$1897	\$948.50
		built-up self edge	GRT12WSBU	48 x 144 x 28.5	70	295.10	18.80	\$2048	\$1024
		slant edge	GRT12WSZS	48 x 144 x 28.5	85	271.10	18.80	\$1897	\$948.50
		• ships in one piece							
	14 foot	self edge	GRT14WS	48 x 168 x 28.5	100	164.25	20.05	\$2559	\$1279.50
		bullnose edge	GRT14WSBN	48 x 168 x 28.5	100	164.25	20.05	\$2559	\$1279.50
		T-mold edge	GRT14WSTM	48 x 168 x 28.5	100	164.25	20.05	\$2559	\$1279.50
		built-up self edge	GRT14WSBU	48 x 168 x 28.5	100	192.30	20.05	\$2774	\$1387
		slant edge	GRT14WSZS	48 x 168 x 28.5	100	164.25	20.05	\$2559	\$1279.50
		• ships in two pieces							
	16 foot	self edge	GRT16WS	48 x 192 x 28.5	92.5	257.18	23.05	\$2559	\$1279.50
		bullnose edge	GRT16WSBN	48 x 192 x 28.5	92.5	257.18	23.05	\$2559	\$1279.50
		T-mold edge	GRT16WSTM	48 x 192 x 28.5	92.5	257.18	23.05	\$2559	\$1279.50
		built-up self edge	GRT16WSBU	48 x 192 x 28.5	85	289.20	23.05	\$2774	\$1387
		slant edge	GRT16WSZS	48 x 192 x 28.5	92.5	257.18	23.05	\$2559	\$1279.50
		• ships in two pieces							

Required Specifications

Finish
Base Finish
Edge Color, if applicable

Optional Specifications

Grommet

Accessories

Power Block

RACETRACK TOP - SCULPTED BASE

	MODEL#	DIMENSIONS	FREIGHT CLASS	WT/LBS.	CUBIC FT.	LIST PRICE	HP ADD
		D x W x H					
18 foot	self edge	GRT18WS	48 x 216 x 28.5	85	390	26.10	\$3089 \$1544.50
	bullnose edge	GRT18WSBN	48 x 216 x 28.5	85	390	26.10	\$3089 \$1544.50
	T-mold edge	GRT18WSTM	48 x 216 x 28.5	85	390	26.10	\$3089 \$1544.50
	built-up self edge	GRT18WSBU	48 x 216 x 28.5	70	426	26.10	\$3305 \$1652.50
	slant edge	GRT18WSZS	48 x 216 x 28.5	85	390	26.10	\$3089 \$1544.50
	• ships in two pieces						
20 foot	self edge	GRT20WS	48 x 240 x 28.5	250	492.20	189.2	\$3518 \$1759
	bullnose edge	GRT20WSBN	48 x 240 x 28.5	250	492.20	189.2	\$3518 \$1759
	T-mold edge	GRT20WSTM	48 x 240 x 28.5	250	492.20	189.2	\$3518 \$1759
	built-up self edge	GRT20WSBU	48 x 240 x 28.5	250	532.20	189.2	\$3733 \$1866.50
	slant edge	GRT20WSZS	48 x 240 x 28.5	250	492.20	189.2	\$3518 \$1759
	• ships in two pieces						
22 foot	self edge	GRT22WS	48 x 264 x 28.5	250	509.50	204.3	\$3945 \$1972.50
	bullnose edge	GRT22WSBN	48 x 264 x 28.5	250	509.50	204.3	\$3945 \$1972.50
	T-mold edge	GRT22WSTM	48 x 264 x 28.5	250	509.50	204.3	\$3945 \$1972.50
	built-up self edge	GRT22WSBU	48 x 264 x 28.5	250	553.50	204.3	\$4159 \$2079.50
	slant edge	GRT22WSZS	48 x 264 x 28.5	250	509.50	204.3	\$3945 \$1972.50
	• ships in two pieces						
24 foot	self edge	GRT24WS	48 x 288 x 28.5	250	542.20	225.2	\$4384 \$2192
	bullnose edge	GRT24WSBN	48 x 288 x 28.5	250	542.20	225.2	\$4384 \$2192
	T-mold edge	GRT24WSTM	48 x 288 x 28.5	250	542.20	225.2	\$4384 \$2192
	built-up self edge	GRT24WSBU	48 x 288 x 28.5	250	590.20	225.2	\$4598 \$2299
	slant edge	GRT24WSZS	48 x 288 x 28.5	250	542.20	225.2	\$4384 \$2192
	• ships in two pieces						

- All tops over 144" are standard in two pieces. Woodgrain laminate finishes will NOT align where the two tops join.
- All tops 120", 144", 168" and 192" are SHIPPED WITH 3 SCULPTED BASES.
- All tops 216" and 240" are SHIPPED WITH 4 SCULPTED BASES.
- All tops 264" and 288" are SHIPPED WITH 5 SCULPTED BASES.

Required Specifications

Finish
Base Finish
Edge Color, if applicable

Optional Specifications

Grommet

Accessories

Power Block

BOAT TOP - SCULPTED BASE

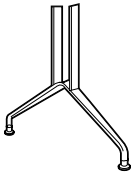
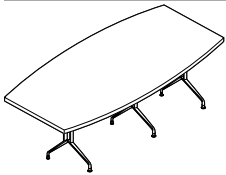

Sculpted Base

		MODEL#	DIMENSIONS	FREIGHT CLASS	WT/LBS.	CUBIC FT.	LIST PRICE	HP ADD
			D x W x H					
5 foot	self edge	GB5S	30 x 60 x 28.5	150	91.40	17.96	\$976	\$488
	bullnose edge	GB5SBN	30 x 60 x 28.5	150	91.40	17.96	\$976	\$488
	T-mold edge	GB5STM	30 x 60 x 28.5	150	91.40	17.96	\$976	\$488
	built-up self edge	GB5SBU	30 x 60 x 28.5	150	91.40	17.96	\$1130	\$565
	slant edge	GB5SZS	30 x 60 x 28.5	150	91.40	17.96	\$976	\$488
• ships in one piece								
6 foot	self edge	GB6S	36 x 72 x 28.5	300	99.40	58.08	\$1087	\$543.50
	bullnose edge	GB6SBN	36 x 72 x 28.5	300	99.40	58.08	\$1087	\$543.50
	T-mold edge	GB6STM	36 x 72 x 28.5	300	99.40	58.08	\$1087	\$543.50
	built-up self edge	GB6SBU	36 x 72 x 28.5	300	106.50	58.08	\$1240	\$620
	slant edge	GB6SZS	36 x 72 x 28.5	300	99.40	58.08	\$1087	\$543.50
• ships in one piece								
7 foot	self edge	GB7S	44 x 84 x 28.5	250	93.40	33.77	\$1224	\$612
	bullnose edge	GB7SBN	44 x 84 x 28.5	250	93.40	33.77	\$1224	\$612
	T-mold edge	GB7STM	44 x 84 x 28.5	250	93.40	33.77	\$1224	\$612
	built-up self edge	GB7SBU	44 x 84 x 28.5	250	123.70	33.77	\$1377	\$688.50
	slant edge	GB7SZS	44 x 84 x 28.5	250	93.40	33.77	\$1224	\$612
• ships in one piece								
8 foot	self edge	GB8WS	48 x 96 x 28.5	300	139.40	92.51	\$1309	\$654.50
	bullnose edge	GB8WSBN	48 x 96 x 28.5	300	139.40	92.51	\$1242	\$621
	T-mold edge	GB8WSTM	48 x 96 x 28.5	300	139.40	92.51	\$1242	\$621
	built-up self edge	GB8WSBU	48 x 96 x 28.5	300	151.40	92.51	\$1394	\$697
	slant edge	GB8WSZS	48 x 96 x 28.5	300	139.40	92.51	\$1242	\$621
• ships in one piece								
10 foot	self edge	GB10WS	48 x 120 x 28.5	250	246.10	101.5	\$1731	\$865.50
	bullnose edge	GB10WSBN	48 x 120 x 28.5	250	246.10	101.5	\$1731	\$865.50
	T-mold edge	GB10WSTM	48 x 120 x 28.5	125	246.10	33.88	\$1731	\$865.50
	built-up self edge	GB10WSBU	48 x 120 x 28.5	125	266.10	33.88	\$1882	\$941
	slant edge	GB10WSZS	48 x 120 x 28.5	125	246.10	33.88	\$1731	\$865.50
• ships in one piece								
12 foot	self edge	GB12WS	48 x 144 x 28.5	250	271.10	110.4	\$1911	\$955.50
	bullnose edge	GB12WSBN	48 x 144 x 28.5	250	271.10	110.4	\$1911	\$955.50
	T-mold edge	GB12WSTM	48 x 120 x 28.5	125	271.10	36.88	\$1911	\$955.50
	built-up self edge	GB12WSBU	48 x 144 x 28.5	100	295.10	36.88	\$2066	\$1033
	slant edge	GB12WSZS	48 x 144 x 28.5	125	271.10	36.88	\$1911	\$955.50
• ships in one piece								
14 foot	self edge	GB14WS	48 x 168 x 28.5	100	164.25	20.05	\$2559	\$1279.50
	bullnose edge	GB14WSBN	48 x 168 x 28.5	100	164.25	20.05	\$2559	\$1279.50
	T-mold edge	GB14WSTM	48 x 168 x 28.5	100	164.25	20.05	\$2559	\$1279.50
	built-up self edge	GB14WSBU	48 x 168 x 28.5	100	192.30	20.05	\$2774	\$1387
	slant edge	GB14WSZS	48 x 168 x 28.5	100	164.25	20.05	\$2559	\$1279.50
• ships in two pieces								
16 foot	self edge	GB16WS	48 x 192 x 28.5	92.5	257.18	23.05	\$2559	\$1279.50
	bullnose edge	GB16WSBN	48 x 192 x 28.5	92.5	257.18	23.05	\$2559	\$1279.50
	T-mold edge	GB16WSTM	48 x 192 x 28.5	92.5	257.18	23.05	\$2559	\$1279.50
	built-up self edge	GB16WSBU	48 x 192 x 28.5	85	289.20	23.05	\$2774	\$1387
	slant edge	GB16WSZS	48 x 192 x 28.5	92.5	257.18	23.05	\$2559	\$1279.50
• ships in two pieces								

Required Specifications

Finish
Base Finish
Edge Color, if applicable

Optional Specifications

Grommet

Accessories

Power Block

BOAT TOP - SCULPTED BASE

	MODEL#	DIMENSIONS	FREIGHT CLASS	WT/LBS.	CUBIC FT.	LIST PRICE	HP ADD
		D x W x H					
18 foot	self edge	GB18WS	48 x 216 x 28.5	85	390	26.10	\$3089 \$1544.50
	bullnose edge	GB18WSBN	48 x 216 x 28.5	85	390	26.10	\$3089 \$1544.50
	T-mold edge	GB18WSTM	48 x 216 x 28.5	85	390	26.10	\$3089 \$1544.50
	built-up self edge	GB18WSBU	48 x 216 x 28.5	70	426	26.10	\$3305 \$1652.50
	slant edge	GB18WSZS	48 x 216 x 28.5	85	390	26.10	\$3089 \$1544.50
20 foot	self edge	GB20WS	48 x 240 x 28.5	250	492.20	189.2	\$3518 \$1759
	bullnose edge	GB20WSBN	48 x 240 x 28.5	250	492.20	189.2	\$3518 \$1759
	T-mold edge	GB20WSTM	48 x 240 x 28.5	250	492.20	189.2	\$3518 \$1759
	built-up self edge	GB20WSBU	48 x 240 x 28.5	250	532.20	189.2	\$3733 \$1866.50
	slant edge	GB20WSZS	48 x 240 x 28.5	250	492.20	189.2	\$3518 \$1759
22 foot	self edge	GB22WS	48 x 264 x 28.5	250	509.50	204.3	\$3945 \$1972.50
	bullnose edge	GB22WSBN	48 x 264 x 28.5	250	509.50	204.3	\$3945 \$1972.50
	T-mold edge	GB22WSTM	48 x 264 x 28.5	250	509.50	204.3	\$3945 \$1972.50
	built-up self edge	GB22WSBU	48 x 264 x 28.5	250	553.50	204.3	\$4159 \$2079.50
	slant edge	GB22WSZS	48 x 264 x 28.5	250	509.50	204.3	\$3945 \$1972.50
24 foot	self edge	GB24WS	48 x 288 x 28.5	250	542.20	225.2	\$4384 \$2192
	bullnose edge	GB24WSBN	48 x 288 x 28.5	250	542.20	225.2	\$4384 \$2192
	T-mold edge	GB24WSTM	48 x 288 x 28.5	250	542.20	225.2	\$4384 \$2192
	built-up self edge	GB24WSBU	48 x 288 x 28.5	250	590.20	225.2	\$4598 \$2299
	slant edge	GB24WSZS	48 x 288 x 28.5	250	542.20	225.2	\$4384 \$2192

- All tops over 144" are standard in two pieces. Woodgrain laminate finishes will NOT align where the two tops join.
- All tops 120", 144", 168" and 192" are SHIPPED WITH 3 SCULPTED BASES.
- All tops 216" and 240" are SHIPPED WITH 4 SCULPTED BASES.
- All tops 264" and 288" are SHIPPED WITH 5 SCULPTED BASES.

Required Specifications

Finish
Base Finish
Edge Color, if applicable

Optional Specifications

Grommet

Accessories

Power Block

ELLIPTICAL TOP - SCULPTED BASE

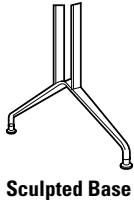
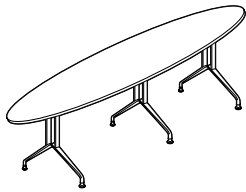

		MODEL#	DIMENSIONS	FREIGHT CLASS	WT/LBS.	CUBIC FT.	LIST PRICE	HP ADD
			D x W x H					
5 foot	self edge	GEL5S	30 x 60 x 28.5	150	91.40	17.96	\$976	\$488
	bullnose edge	GEL5SBN	30 x 60 x 28.5	150	91.40	17.96	\$976	\$488
	T-mold edge	GEL5STM	30 x 60 x 28.5	150	91.40	17.96	\$976	\$488
	built-up self edge	GEL5SBU	30 x 60 x 28.5	150	91.40	17.96	\$1130	\$565
	slant edge	GEL5SZS	30 x 60 x 28.5	150	91.40	17.96	\$976	\$488
								• ships in one piece
6 foot	self edge	GEL6S	36 x 72 x 28.5	85	97.40	7.48	\$1069	\$534.50
	bullnose edge	GEL6SBN	36 x 72 x 28.5	150	97.40	22.40	\$1069	\$534.50
	T-mold edge	GEL6STM	36 x 72 x 28.5	150	97.40	22.40	\$1069	\$534.50
	built-up self edge	GEL6SBU	36 x 72 x 28.5	150	106.40	22.40	\$1221	\$610.50
	slant edge	GEL6SZS	36 x 72 x 28.5	150	97.40	22.40	\$1069	\$534.50
								• ships in one piece
7 foot	self edge	GEL7S	44 x 84 x 28.5	250	91.40	33.77	\$1224	\$612
	bullnose edge	GEL7SBN	44 x 84 x 28.5	250	91.40	33.77	\$1224	\$612
	T-mold edge	GEL7STM	44 x 84 x 28.5	250	91.40	33.77	\$1224	\$612
	built-up self edge	GEL7SBU	44 x 84 x 28.5	250	123.70	33.77	\$1377	\$688.50
	slant edge	GEL7SZS	44 x 84 x 28.5	250	91.40	33.77	\$1224	\$612
								• ships in one piece
8 foot	self edge	GEL8WS	48 x 96 x 28.5	250	137.40	38.29	\$1224	\$612
	bullnose edge	GEL8WSBN	48 x 96 x 28.5	250	137.40	38.29	\$1224	\$612
	T-mold edge	GEL8WSTM	48 x 96 x 28.5	250	137.40	38.29	\$1224	\$612
	built-up self edge	GEL8WSBU	48 x 96 x 28.5	150	153.40	12.79	\$1377	\$688.50
	slant edge	GEL8WSZS	48 x 96 x 28.5	250	137.40	12.79	\$1224	\$612
								• ships in one piece
10 foot	self edge	GEL10WS	48 x 120 x 28.5	70	244.10	15.80	\$1712	\$856
	bullnose edge	GEL10WSBN	48 x 120 x 28.5	70	244.10	15.80	\$1712	\$856
	T-mold edge	GEL10WSTM	48 x 120 x 28.5	70	244.10	15.80	\$1712	\$856
	built-up self edge	GEL10WSBU	48 x 120 x 28.5	70	264.10	15.80	\$1866	\$933
	slant edge	GEL10WSZS	48 x 120 x 28.5	70	244.10	15.80	\$1712	\$856
								• ships in one piece
12 foot	self edge	GEL12WS	48 x 144 x 28.5	85	269.10	18.80	\$1897	\$948.50
	bullnose edge	GEL12WSBN	48 x 144 x 28.5	85	269.10	18.80	\$1897	\$948.50
	T-mold edge	GEL12WSTM	48 x 144 x 28.5	125	269.10	37.62	\$1897	\$948.50
	built-up self edge	GEL12WSBU	48 x 144 x 28.5	70	293.10	18.80	\$2048	\$1024
	slant edge	GEL12WSZS	48 x 144 x 28.5	85	269.10	18.80	\$1897	\$948.50
								• ships in one piece
14 foot	self edge	GEL14WS	48 x 168 x 28.5	100	164.25	20.05	\$2559	\$1279.50
	bullnose edge	GEL14WSBN	48 x 168 x 28.5	100	164.25	20.05	\$2559	\$1279.50
	T-mold edge	GEL14WSTM	48 x 168 x 28.5	100	164.25	20.05	\$2559	\$1279.50
	built-up self edge	GEL14WSBU	48 x 168 x 28.5	100	192.30	20.05	\$2774	\$1387
	slant edge	GEL14WSZS	48 x 168 x 28.5	100	164.25	20.05	\$2559	\$1279.50
								• ships in two pieces
16 foot	self edge	GEL16WS	48 x 192 x 28.5	92.5	257.18	23.05	\$2559	\$1279.50
	bullnose edge	GEL16WSBN	48 x 192 x 28.5	92.5	257.18	23.05	\$2559	\$1279.50
	T-mold edge	GEL16WSTM	48 x 192 x 28.5	92.5	257.18	23.05	\$2559	\$1279.50
	built-up self edge	GEL16WSBU	48 x 192 x 28.5	85	289.20	23.05	\$2774	\$1387
	slant edge	GEL16WSZS	48 x 192 x 28.5	92.5	257.18	23.05	\$2559	\$1279.50
								• ships in two pieces

Required Specifications

Finish
Base Finish
Edge Color, if applicable

Optional Specifications

Grommet

Accessories

Power Block

ELLIPTICAL TOP - SCULPTED BASE

	MODEL#	DIMENSIONS	FREIGHT CLASS	WT/LBS.	CUBIC FT.	LIST PRICE	HP ADD
		D x W x H					
18 foot	self edge	GEL18WS	48 x 216 x 28.5	85	390	26.10	\$3445 \$1722.50
	bullnose edge	GEL18WSBN	48 x 216 x 28.5	85	390	26.10	\$3445 \$1722.50
	T-mold edge	GEL18WSTM	48 x 216 x 28.5	85	390	26.10	\$3445 \$1722.50
	built-up self edge	GEL18WSBU	48 x 216 x 28.5	70	426	26.10	\$3661 \$1830.50
	slant edge	GEL18WSZS	48 x 216 x 28.5	85	390	26.10	\$3445 \$1722.50
	• ships in two pieces						
20 foot	self edge	GEL20WS	48 x 240 x 28.5	70	492.20	31.50	\$3937 \$1968.50
	bullnose edge	GEL20WSBN	48 x 240 x 28.5	70	492.20	31.50	\$3937 \$1968.50
	T-mold edge	GEL20WSTM	48 x 240 x 28.5	70	492.20	31.50	\$3937 \$1968.50
	built-up self edge	GEL20WSBU	48 x 240 x 28.5	70	532.20	31.50	\$4148 \$2074
	slant edge	GEL20WSZS	48 x 240 x 28.5	70	492.20	31.50	\$3937 \$1968.50
	• ships in two pieces						
22 foot	self edge	GEL22WS	48 x 264 x 28.5	85	509.20	34.01	\$4324 \$2162
	bullnose edge	GEL22WSBN	48 x 264 x 28.5	85	509.20	34.01	\$4324 \$2162
	T-mold edge	GEL22WSTM	48 x 264 x 28.5	85	509.20	34.01	\$4324 \$2162
	built-up self edge	GEL22WSBU	48 x 264 x 28.5	70	553.20	34.01	\$4538 \$2269
	slant edge	GEL22WSZS	48 x 264 x 28.5	85	509.20	34.01	\$4324 \$2162
	• ships in two pieces						
24 foot	self edge	GEL24WS	48 x 288 x 28.5	85	542.20	37.54	\$4752 \$2376
	bullnose edge	GEL24WSBN	48 x 288 x 28.5	85	542.20	37.54	\$4752 \$2376
	T-mold edge	GEL24WSTM	48 x 288 x 28.5	85	542.20	37.54	\$4752 \$2376
	built-up self edge	GEL24WSBU	48 x 288 x 28.5	70	590.20	37.54	\$4965 \$2482.50
	slant edge	GEL24WSZS	48 x 288 x 28.5	85	542.20	37.54	\$4752 \$2376
	• ships in two pieces						

- All tops over 144" are standard in two pieces. Woodgrain laminate finishes will NOT align where the two tops join.
- All tops 120", 144", 168" and 192" are SHIPPED WITH 3 SCULPTED BASES.
- All tops 216" and 240" are SHIPPED WITH 4 SCULPTED BASES.
- All tops 264" and 288" are SHIPPED WITH 5 SCULPTED BASES.

Required Specifications

Finish
Base Finish
Edge Color, if applicable

Optional Specifications

Grommet

Accessories

Power Block

B BOARDROOM TABLES



Sturdy and economically priced, Global boardroom tables are excellent choices. All tables are made from thermally fused, high performance laminate and are easy to maintain.

Choose from four attractive table edges: Bullnose, T-mold, Self-edge, or Built-up Self-edge. Available in a variety of colors, all edge options are durable and wear-resistant.

Table tops are offered in five shapes - rectangular, racetrack, boat-shaped, square and round - and a variety of bases including slab, drum and arch. Add to this an impressive variety of laminate finishes that may be mixed and matched and you'll find Global can satisfy any and every business need.

From small meeting rooms to large boardrooms, from traditional to contemporary, Global's incredible range of table components, shapes, sizes and colors will enhance any office decor.



Features and Benefits

- One-piece tops can be cut to 2 pieces for an upcharge
- Tables 96" to 144" in length special ordered with two piece tops must have a third base
- All tops are premarked as to base location
- All tops are 1 1/8" thick - a 1 3/4" built-up self edge is available on all models
- Tops and bases boxed as appropriate
- Custom finish laminate tables available as special order
- Bullnose edges available in Black or Grey
- T-Mold edge available in Black, Grey or coordinating laminate finish.
- Self-edge and built-up self edge available in same color as laminate finish.
- All edges available on all tables
- Metal legs and bases are standard in Chrome - also available in Black or Grey

GENERAL INFORMATION

- All tables are 29" high and constructed of 45 lb. density particle board
- Tables 144" or less are standard in one piece
- All tops over 144" are standard in two pieces
- Five top shapes: Rectangular, Racetrack, Boat-Shaped, Square and Round
- Four edge options: Bullnose, T-Mold, Self-edge or Built-Up Self Edge
- Global laminate and seating products are in compliance with stringent emission guidelines set out by the Greenguard Environmental Institute under the standards for low emitting products and materials. www.greenguard.org
- **Level 2 Certified**

CONSTRUCTION

- All Boardroom tables are 29" high and made of 45 lb. density particle board covered on both sides with high performance, thermally fused laminate. Table width is nominal.
- All tables with cross bases use Blum fasteners
- All tops are 1 1/8" thick with high performance, thermally fused laminate on both sides. A 1 3/4" built-up self edge is available on all models.
- Tops are crated and bases boxed or crated as appropriate
- Table tops of 144" or less in length are standard as one piece. 1 piece tops can be cut to 2 piece tops, **Add \$224**; however, an additional base will be required. Tables 96" to 144" in length special ordered with 2 piece tops **must** have a third base.
- All Tops are **PREMARKED** as to base location, and the slot and hook assembly method (on selected tables) allows for easy installation.
- All racetrack, boat and rectangular tables 144" and under are standard with 2 drum, slab, arch, 2-legged, or tubular bases and are priced accordingly. For 3 bases, **Add \$313** list per table for a drum, and **Add \$242** list per table for the slab. The arch base tables will require a special 3" thick slab at a list price of **\$327** per table. **Add \$313** list per table for 2-legged base, and **Add \$327** list per table for tubular.
- Custom size tables are priced at next size table price, not to exceed width or length. Example: 44" x 108" would be priced at the 48" x 120" price. Contact Customer Service for pricing of tables over 48" in width. Custom tables **less** than the smallest size must be quoted.
- Products specified with the high pressure laminate option are finished on the underside of the surface with a kraft paper backing.

EDGE OPTIONS

- Self, built-up, bullnose, T-mold and slant edges are available on all models. Corners of rectangular, square and boat shaped tables ordered with T-mold or bullnose will be rounded.
- **Bullnose** edge is available in Black (**BK**) or Grey (**GR**) only.
- **T-mold** edge is available in Black (**BK**), Grey (**GR**) or coordinating laminate finish (**ME**)
- **Self edge and built-up** edges are same color as laminate finish.
- Metal bases are standard in Chrome (**CH**). Also available in Black (**BLK**) or Grey (**GR**). Please specify when ordering if a color other than Chrome is desired.

LAMINATE FINISHES

ACJ	Absolute Acajou	HGT	Hayden Grey
ASN	Asian Night	QTM	Quartered Mahogany
AWC	Avant Cherry	SOG	Storm Grey
AWH	Avant Honey	TFW	Tiger Fruitwood
BLK	Black	TWL	Tiger Walnut
BRC	Brushed Cobalt	WHE	Walnut Heights
CMB	Clear Maple	WHC	White Chocolate
DES	Dark Espresso	WCR	Winter Cherry
DWT	Designer White	WGY	Willow Grey

- White Chocolate (**WHC**) not available on 10 & 12 foot tables. Must be cut in two pieces and specify third base.
- The above laminate finishes are available in **High Pressure**. Upcharge varies by model.
- Tables in woodgrain finishes over 12' in length will not have a perfect match of grain at the center where the two halves meet.
- All tables with Drum Bases & Pedestal require approx. 125 lb. of sand in each base for adequate stability. Sand is not included with Drum Bases.

- If other than a Global standard laminate finish is preferred, contact your customer care Representative. Information needed includes the name of the laminate manufacturer, color name, number and model of table. You will then be given a quote for this special order.

BASE SIZE CHART (Table width is nominal)

Round or Square Tops:

Top	Slab	Drum	Arch	Cross	4 Leg	Trumpet	4 Tube
36"	n/a	n/a	n/a	n/a	32"	24"	30"
42"	n/a	18"	n/a	30"	32"	24"	30"
48"	n/a	24"	n/a	30"	32"	n/a	30"
60"	n/a	30"	n/a	36"	n/a	n/a	n/a

Rectangular, Boat or Racetrack Tops:

Top	Slab	Drum	Arch	Cross	2 Leg	Trumpet	2/3 Tube
36" x 72"	24"	18"	24"	n/a	32"	n/a	30"
48" x 96"	28"	18"	28"	n/a	32"	n/a	30"
48" x 120"	28"	24"	28"	n/a	32"	n/a	30"
48" x 144"	28"	24"	28"	n/a	32"	n/a	30"

GROMMETS

- Grommets available in standard table top locations (left, center or right). Order as: **AG1, AG2 or AG3. Add \$69.**
- Grommet hole dimensions are 3 1/4" wide x 1 7/8" deep.



- Actual grommet locations will vary according to base selection.

POWER BLOCK

- A Power Block (model **PMSPDM**) may be ordered on all worksurfaces.
- A Power Block is a rectangular worksurface power/data module with one electrical duplex receptacle and two data (RJ45) receptacles. 9' black cord included. Power Block dimensions are 3 1/2" deep x 6 1/2" wide x 2 3/4" high.
- Actual Power Block locations vary according to base selection. The locations will be left (AG1, E1), center (AG2, E2), and right (AG3, E3). **Example:** 8' table with drum base does not have a modesty panel, so the grommet (AG2) and power block (E2) can be perfectly centered in the table. An 8' table with a slab base has the modesty panel, so the grommet (AG2) and power block (E2) will be offset alongside the modesty panel.
- To purchase a Power Block, you must specify both the Power Block cut-out location and the Power Block model #. Order Power Block as **PMSPDM, Add \$261.** Power Blocks are available in standard worksurface locations (left, center or right). Order as **E1, E2 or E3. Add \$69.**



Power Block **PMSPDM - Add \$261**

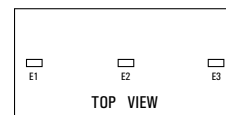

Specify location **E1, E2 or E3 - Add \$69**

B BOARDROOM TABLES

TABLE NOTES - ESTIMATED CAPACITY

• Use the following for determining the size of a round table and the number of chairs needed for a conference area. All estimates are based on an average chair width of 23" with a 4" clearance between chairs. Adjust accordingly for a different chair size.

Top Size	Round	Square	Rectangular	Boat	Racetrack	Elliptical
30x30	3	3	N/A	N/A	N/A	N/A
36x36	4	4	N/A	N/A	N/A	N/A
42x42	4	4	N/A	N/A	N/A	N/A
48x48	4	4	N/A	N/A	N/A	N/A
60x60	5	6	N/A	N/A	N/A	N/A
30x60	N/A	N/A	4-6	4-6	4-6	4
36x72	N/A	N/A	4-6	4-6	4-6	4
44x84	N/A	N/A	6-8	6-8	6-8	6
48x96	N/A	N/A	6-8	6-8	6-8	6
48x120	N/A	N/A	8-10	8-10	8-10	8
48x144	N/A	N/A	10-12	10-12	10-12	10
48x168	N/A	N/A	12-14	12-14	12-14	12
48x192	N/A	N/A	14-16	14-16	14-16	14
48x216	N/A	N/A	16-18	16-18	16-18	16
48x240	N/A	N/A	18-20	18-20	18-20	18
48x264	N/A	N/A	20-22	20-22	20-22	20
48x288	N/A	N/A	22-24	22-24	22-24	22

BASE OPTIONS

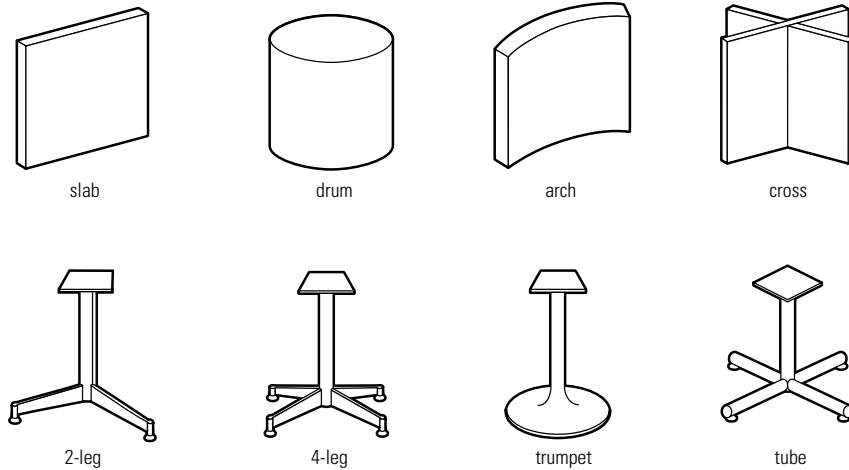

EDGE OPTIONS

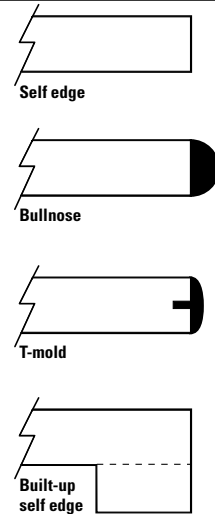
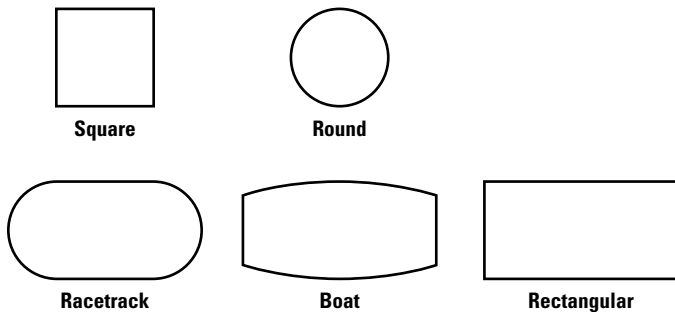
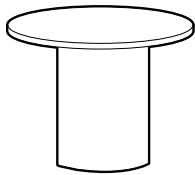

TABLE TOP STYLES



ROUND TOP - DRUM BASE



	MODEL#	DIMENSIONS	FREIGHT	CLASS	WT./LBS.	CUBIC FT.	LIST PRICE	HP ADD
		D x W x H						
self edge	G42CZ	42 x 42 x 29	92.5		89	8.50	\$670	\$335
bullnose edge	G42CZBN	42 x 42 x 29	92.5		86	8.50	\$670	\$335
T-mold edge	G42CZTM	42 x 42 x 29	92.5		90	8.50	\$670	\$335
built-up self edge	G42CZBU	42 x 42 x 29	92.5		96	9.40	\$743	\$371.50
self edge	G48CZ	48 x 48 x 29	125		106	13.60	\$774	\$387
bullnose edge	G48CZBN	48 x 48 x 29	100		117	13.60	\$774	\$387
T-mold edge	G48CZTM	48 x 48 x 29	100		121	13.60	\$774	\$387
built-up self edge	G48CZBU	48 x 48 x 29	100		133	14.90	\$863	\$431.50
self edge	G60CZ	60 x 60 x 29	100		171	21	\$970	\$485
bullnose edge	G60CZBN	60 x 60 x 29	100		171	21	\$970	\$485
T-mold edge	G60CZTM	60 x 60 x 29	100		171	21	\$970	\$485
built-up self edge	G60CZBU	60 x 60 x 29	125		174	23.20	\$1142	\$571

• All Drum Bases require approx. 125 lb. of sand in each base for adequate stability. Sand is not included.

ROUND TOP - CROSS BASE

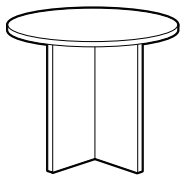

self edge	G42CH	42 x 42 x 29	70		97	5	\$622	\$311
bullnose edge	G42CHBN	42 x 42 x 29	70		94	5	\$622	\$311
T-mold edge	G42CHTM	42 x 42 x 29	70		98	5	\$622	\$311
built-up self edge	G42CHBU	42 x 42 x 29	70		104	5.70	\$670	\$335
self edge	G48CH	48 x 48 x 29	70		101	6	\$726	\$363
bullnose edge	G48CHBN	48 x 48 x 29	70		112	6	\$726	\$363
T-mold edge	G48CHTM	48 x 48 x 29	70		116	6	\$726	\$363
built-up self edge	G48CHBU	48 x 48 x 29	70		128	6.60	\$832	\$416
self edge	G60CH	60 x 60 x 29	70		174	9	\$929	\$464.50
bullnose edge	G60CHBN	60 x 60 x 29	125		64	9	\$929	\$464.50
T-mold edge	G60CHTM	60 x 60 x 29	125		64	9	\$929	\$464.50
built-up self edge	G60CHBU	60 x 60 x 29	70		190	9.70	\$1095	\$547.50

ROUND TOP - 4 LEG BASE



self edge	GCAR36	36 x 36 x 29	250		48	13	\$451	\$225.50
bullnose edge	GCAR36BN	36 x 36 x 29	150		55	13	\$451	\$225.50
T-mold edge	GCAR36TM	36 x 36 x 29	250		48	13	\$451	\$225.50
built-up self edge	GCAR36BU	36 x 36 x 29	150		68	13	\$502	\$251
self edge	GCAR42	42 x 42 x 29	150		59	14	\$538	\$269
bullnose edge	GCAR42BN	42 x 42 x 29	150		68	14	\$538	\$269
T-mold edge	GCAR42TM	42 x 42 x 29	150		61	14	\$538	\$269
built-up self edge	GCAR42BU	42 x 42 x 29	150		78	14	\$594	\$297
self edge	GCAR48	48 x 48 x 29	150		72	15	\$631	\$315.50
bullnose edge	GCAR48BN	48 x 48 x 29	150		83	15	\$631	\$315.50
T-mold edge	GCAR48TM	48 x 48 x 29	150		87	15	\$631	\$315.50
built-up self edge	GCAR48BU	48 x 48 x 29	125		99	15	\$700	\$350

Required Specifications

Finish
Base Finish
Edge Color, if applicable

B BOARDROOM TABLES

ROUND TOP - TRUMPET BASE

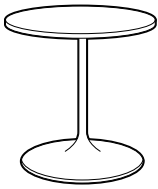

	MODEL#	DIMENSIONS	FREIGHT	CLASS	WT/LBS.	CUBIC FT.	LIST PRICE	HP ADD
		D x W x H						
self edge	GTCR36	36 x 36 x 29	250	54	19	\$631	\$315.50	
bullnose edge	GTCR36BN	36 x 36 x 29	250	61	18	\$631	\$315.50	
T-mold edge	GTCR36TM	36 x 36 x 29	250	54	18	\$631	\$315.50	
built-up self edge	GTCR36BU	36 x 36 x 29	150	74	18	\$700	\$350	
self edge	GTCR42	42 x 42 x 29	150	77	19	\$708	\$354	
bullnose edge	GTCR42BN	42 x 42 x 29	250	74	19	\$708	\$354	
T-mold edge	GTCR42TM	42 x 42 x 29	150	78	19	\$708	\$354	
built-up self edge	GTCR42BU	42 x 42 x 29	150	84	19	\$788	\$394	

ROUND TOP - TUBULAR BASE

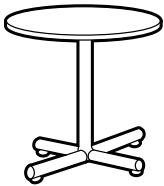

self edge	GCCR36	36 x 36 x 29	250	50	18	\$544	\$272
bullnose edge	GCCR36BN	36 x 36 x 29	250	57	19	\$544	\$272
T-mold edge	GCCR36TM	36 x 36 x 29	250	50	19	\$544	\$272
built-up self edge	GCCR36BU	36 x 36 x 29	250	70	19	\$606	\$303
self edge	GCCR42	42 x 42 x 29	250	61	19	\$631	\$315.50
bullnose edge	GCCR42BN	42 x 42 x 29	250	70	19	\$631	\$315.50
T-mold edge	GCCR42TM	42 x 42 x 29	250	63	19	\$631	\$315.50
built-up self edge	GCCR42BU	42 x 42 x 29	150	80	19	\$700	\$350
self edge	GCCR48	48 x 48 x 29	250	74	20	\$726	\$363
bullnose edge	GCCR48BN	48 x 48 x 29	150	85	20	\$726	\$363
T-mold edge	GCCR48TM	48 x 48 x 29	150	89	20	\$726	\$363
built-up self edge	GCCR48BU	48 x 48 x 29	150	101	20	\$803	\$401.50

SQUARE TOP - DRUM BASE

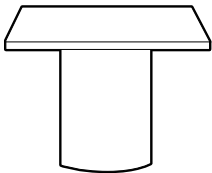

self edge	G42SZ	42 x 42 x 29	100	89	9	\$670	\$335
bullnose edge	G42SZBN	42 x 42 x 29	100	89	9	\$670	\$335
T-mold edge	G42SZTM	42 x 42 x 29	100	89	9	\$670	\$335
built-up self edge	G42SZBU	42 x 42 x 29	92.5	106	9.40	\$743	\$371.50
self edge	G48SZ	48 x 48 x 29	100	121	13.40	\$774	\$387
bullnose edge	G48SZBN	48 x 48 x 29	100	121	13.40	\$774	\$387
T-mold edge	G48SZTM	48 x 48 x 29	100	121	13.60	\$774	\$387
built-up self edge	G48SZBU	48 x 48 x 29	100	133	14.90	\$863	\$431.50
self edge	G60SZ	60 x 60 x 29	100	171	21	\$970	\$485
bullnose edge	G60SZBN	60 x 60 x 29	100	171	21	\$970	\$485
T-mold edge	G60SZTM	60 x 60 x 29	100	171	21	\$970	\$485
built-up self edge	G60SZBU	60 x 60 x 29	125	174	23.20	\$1142	\$571

- All Drum Bases require approx. 125 lb. of sand in each base for adequate stability. Sand is not included.

SQUARE TOP - CROSS BASE

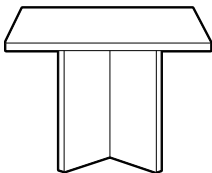

self edge	G42SH	42 x 42 x 29	70	97	5	\$622	\$311
bullnose edge	G42SHBN	42 x 42 x 29	70	97	5	\$622	\$311
T-mold edge	G42SHTM	42 x 42 x 29	70	97	5	\$622	\$311
built-up self edge	G42SHBU	42 x 42 x 29	70	114	5.70	\$670	\$335
self edge	G48SH	48 x 48 x 29	70	116	6	\$726	\$363
bullnose edge	G48SHBN	48 x 48 x 29	70	116	6	\$726	\$363
T-mold edge	G48SHTM	48 x 48 x 29	70	116	6	\$726	\$363
built-up self edge	G48SHBU	48 x 48 x 29	70	122	6.40	\$832	\$416
self edge	G60SH	60 x 60 x 29	125	64	9	\$929	\$464.50
bullnose edge	G60SHBN	60 x 60 x 29	125	64	9	\$929	\$464.50
T-mold edge	G60SHTM	60 x 60 x 29	125	64	9	\$929	\$464.50
built-up self edge	G60SHBU	60 x 60 x 29	125	64	9.70	\$1095	\$547.50

Required Specifications

Finish
Base Finish
Edge Color, if applicable

Optional Specifications

HP laminate

SQUARE TOP - 4 LEG BASE



	MODEL#	DIMENSIONS	FREIGHT	CLASS	WT/LBS.	CUBIC FT.	LIST PRICE	HP ADD
		D x W x H						
self edge	GCAS36	36 x 36 x 29	150		63	13	\$451	\$225.50
bullnose edge	GCAS36BN	36 x 36 x 29	150		63	13	\$451	\$225.50
T-mold edge	GCAS36TM	36 x 36 x 29	150		63	13	\$451	\$225.50
built-up self edge	GCAS36BU	36 x 36 x 29	150		67	13	\$502	\$251
self edge	GCAS42	42 x 42 x 29	150		71	14	\$538	\$269
bullnose edge	GCAS42BN	42 x 42 x 29	150		78	14	\$538	\$269
T-mold edge	GCAS42TM	42 x 42 x 29	150		78	14	\$538	\$269
built-up self edge	GCAS42BU	42 x 42 x 29	125		86	14	\$594	\$297
self edge	GCAS48	48 x 48 x 29	125		97	15	\$631	\$315.50
bullnose edge	GCAS48BN	48 x 48 x 29	125		97	15	\$631	\$315.50
T-mold edge	GCAS48TM	48 x 48 x 29	125		97	15	\$631	\$315.50
built-up self edge	GCAS48BU	48 x 48 x 29	125		108	15	\$700	\$350

SQUARE TOP - TRUMPET BASE



self edge	GTCS36	36 x 36 x 29	250		69	18	\$631	\$315.50
bullnose edge	GTCS36BN	36 x 36 x 29	250		69	18	\$631	\$315.50
T-mold edge	GTCS36TM	36 x 36 x 29	250		69	18	\$631	\$315.50
built-up self edge	GTCS36BU	36 x 36 x 29	150		76	18	\$700	\$350
self edge	GTCS42	42 x 42 x 29	150		77	19	\$708	\$354
bullnose edge	GTCS42BN	42 x 42 x 29	150		77	19	\$708	\$354
T-mold edge	GTCS42TM	42 x 42 x 29	150		77	19	\$708	\$354
built-up self edge	GTCS42BU	42 x 42 x 29	150		84	19	\$788	\$394

SQUARE TOP - TUBULAR BASE



self edge	GCRS36	36 x 36 x 29	250		65	18	\$544	\$272
bullnose edge	GCRS36BN	36 x 36 x 29	250		65	18	\$544	\$272
T-mold edge	GCRS36TM	36 x 36 x 29	250		65	18	\$544	\$272
built-up self edge	GCRS36BU	36 x 36 x 29	250		69	18	\$606	\$303
self edge	GCRS42	42 x 42 x 29	250		73	19	\$631	\$315.50
bullnose edge	GCRS42BN	42 x 42 x 29	150		80	19	\$631	\$315.50
T-mold edge	GCRS42TM	42 x 42 x 29	150		80	19	\$631	\$315.50
built-up self edge	GCRS42BU	42 x 42 x 29	150		88	19	\$700	\$350
self edge	GCRS48	48 x 48 x 29	150		101	20	\$726	\$363
bullnose edge	GCRS48BN	48 x 48 x 29	150		101	20	\$726	\$363
T-mold edge	GCRS48TM	48 x 48 x 29	150		101	20	\$726	\$363
built-up self edge	GCRS48BU	48 x 48 x 29	150		109	20	\$803	\$401.50

Required Specifications

Finish
Base Finish
Edge Color, if applicable

Optional Specifications

HP laminate

B BOARDROOM TABLES

RECTANGULAR TOP - SLAB BASE

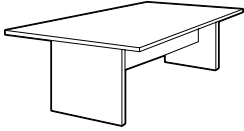

		MODEL#	DIMENSIONS	FREIGHT CLASS	WT/LBS.	CUBIC FT.	LIST PRICE	HP ADD
			D x W x H					
5 foot	self edge	GCT5RX	30 x 60 x 29	70	131	6	\$785	\$392.50
	bullnose edge	GCT5RXBN	30 x 60 x 60	70	131	6	\$785	\$392.50
	T-mold edge	GCT5RXTM	30 x 60 x 29	70	131	6	\$785	\$392.50
	built-up self edge	GCT5RXBU	30 x 60 x 29	70	134	7	\$868	\$434
6 foot	self edge	GCT6RX	36 x 72 x 29	70	174	11.38	\$880	\$440
	bullnose edge	GCT6RXBN	36 x 72 x 29	70	174	11.38	\$880	\$440
	T-mold edge	GCT6RXTM	36 x 72 x 29	70	174	11.38	\$880	\$440
	built-up self edge	GCT6RXBU	36 x 72 x 29	85	177	13.32	\$981	\$490.50
7 foot	self edge	GCT7RX	44 x 84 x 29	85	199	14.94	\$1133	\$566.50
	bullnose edge	GCT7RXBN	44 x 84 x 29	85	199	14.94	\$1133	\$566.50
	T-mold edge	GCT7RXTM	44 x 84 x 84	85	199	14.94	\$1133	\$566.50
	built-up self edge	GCT7RXBU	44 x 84 x 84	92.5	203	17.93	\$1279	\$639.50
8 foot	self edge	GCT8WRX	48 x 96 x 29	70	218	11.29	\$1133	\$566.50
	bullnose edge	GCT8WRXBN	48 x 96 x 29	70	218	11.29	\$1133	\$566.50
	T-mold edge	GCT8WRXTM	48 x 96 x 29	70	218	11.29	\$1133	\$566.50
	built-up self edge	GCT8WRXBU	48 x 96 x 29	70	249	13.53	\$1279	\$639.50
10 foot	self edge	GCT10WRX2	48 x 120 x 29	70	272	13.53	\$1313	\$656.50
	bullnose edge	GCT10WRX2BN	48 x 120 x 29	70	272	13.53	\$1313	\$656.50
	T-mold edge	GCT10WRX2TM	48 x 120 x 29	70	272	13.53	\$1313	\$656.50
	built-up self edge	GCT10WRX2BU	48 x 120 x 29	70	291	16.20	\$1554	\$777
12 foot	self edge	GCT12WRX2	48 x 144 x 29	70	309	15.54	\$1541	\$770.50
	bullnose edge	GCT12WRX2BN	48 x 144 x 29	70	309	15.54	\$1541	\$770.50
	T-mold edge	GCT12WRX2TM	48 x 144 x 29	70	309	15.54	\$1541	\$770.50
	built-up self edge	GCT12WRX2BU	48 x 144 x 29	70	348	18.77	\$1809	\$904.50
14 foot	self edge	GCT14WRX2	48 x 168 x 29	70	419	22.50	\$2229	\$1114.50
	bullnose edge	GCT14WRX2BN	48 x 168 x 29	70	419	22.50	\$2229	\$1114.50
	T-mold edge	GCT14WRX2TM	48 x 168 x 29	65	419	18	\$2229	\$1114.50
	built-up self edge	GCT14WRX2BU	48 x 168 x 29	70	425	20	\$2488	\$1244
16 foot	self edge	GCT16WRX2	48 x 192 x 29	70	460	22.72	\$2323	\$1161.50
	bullnose edge	GCT16WRX2BN	48 x 192 x 29	70	460	22.72	\$2323	\$1161.50
	T-mold edge	GCT16WRX2TM	48 x 192 x 29	70	460	22.70	\$2323	\$1161.50
	built-up self edge	GCT16WRX2BU	48 x 192 x 29	70	466	27.20	\$2594	\$1297
18 foot	self edge	GCT18WRX2	48 x 216 x 29	70	521	24.60	\$2891	\$1445.50
	bullnose edge	GCT18WRX2BN	48 x 216 x 29	70	521	24.60	\$2891	\$1445.50
	T-mold edge	GCT18WRX2TM	48 x 216 x 29	70	521	24.60	\$2891	\$1445.50
	built-up self edge	GCT18WRX2BU	48 x 216 x 29	70	528	29.80	\$3241	\$1620.50
20 foot	self edge	GCT20WRX2	48 x 240 x 29	70	572	26.60	\$2937	\$1468.50
	bullnose edge	GCT20WRX2BN	48 x 240 x 29	70	572	26.60	\$2937	\$1468.50
	T-mold edge	GCT20WRX2TM	48 x 240 x 29	70	572	26.60	\$2937	\$1468.50
	built-up self edge	GCT20WRX2BU	48 x 240 x 29	70	580	32.50	\$3288	\$1644
22 foot	self edge	GCT22WRX2	48 x 264 x 29	70	612	28.90	\$3410	\$1705
	bullnose edge	GCT22WRX2BN	48 x 264 x 29	70	612	28.90	\$3410	\$1705
	T-mold edge	GCT22WRX2TM	48 x 264 x 29	70	612	28.90	\$3410	\$1705
	built-up self edge	GCT22WRX2BU	48 x 264 x 29	70	620	35.10	\$3765	\$1882.50
24 foot	self edge	GCT24WRX2	48 x 288 x 29	70	673	31.20	\$3506	\$1753
	bullnose edge	GCT24WRX2BN	48 x 288 x 29	70	673	31.20	\$3506	\$1753
	T-mold edge	GCT24WRX2TM	48 x 288 x 29	70	673	31.20	\$3506	\$1753
	built-up self edge	GCT24WRX2BU	48 x 288 x 29	70	682	37.70	\$3878	\$1939

- All tops over 144" are standard in two pieces. Woodgrain laminate finishes will NOT align where the two tops join.
- All tops 168", 192", 216" and 240" are SHIPPED WITH 3 SLAB BASES.
- All tops 264" and 288" are SHIPPED WITH 4 SLAB BASES.

Required Specifications

Finish
Base Finish
Edge Color, if applicable

Optional Specifications

Grommet
HP laminate

Accessories

Power Block

RECTANGULAR TOP - DRUM BASE

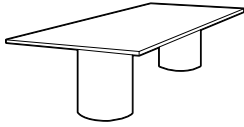

	MODEL#	DIMENSIONS	FREIGHT	CLASS	WT/LBS.	CUBIC FT.	LIST PRICE	HP ADD
		D x W x H						
6 foot	self edge	GCT6RZ	36 x 72 x 29	100	154	17.50	\$1189	\$594.50
	bullnose edge	GCT6RZBN	36 x 72 x 29	100	167	17.50	\$1189	\$594.50
	T-mold edge	GCT6RZTM	36 x 72 x 29	100	167	17.50	\$1189	\$594.50
	built-up self edge	GCT6RZBU	36 x 72 x 29	100	177	18.80	\$1331	\$665.50
7 foot	self edge	GCT7RZ	44 x 84 x 29	125	196	29.04	\$1378	\$689
	bullnose edge	GCT7RZBN	44 x 84 x 29	125	196	29.04	\$1378	\$689
	T-mold edge	GCT7RZTM	44 x 84 x 29	125	196	29.04	\$1378	\$689
	built-up self edge	GCT7RZBU	44 x 84 x 29	125	199	31.66	\$1519	\$759.50
8 foot	self edge	GCT8WRZ	48 x 96 x 29	125	219	31.82	\$1378	\$689
	bullnose edge	GCT8WRZBN	48 x 96 x 29	125	219	31.82	\$1378	\$689
	T-mold edge	GCT8WRZTM	48 x 96 x 29	125	219	31.82	\$1378	\$689
	built-up self edge	GCT8WRZBU	48 x 96 x 29	125	250	35.18	\$1519	\$759.50
10 foot	self edge	GCT10WRZ2	48 x 120 x 29	100	295	33	\$1615	\$807.50
	bullnose edge	GCT10WRZ2BN	48 x 120 x 29	100	295	33	\$1615	\$807.50
	T-mold edge	GCT10WRZ2TM	48 x 120 x 29	100	295	33.02	\$1615	\$807.50
	built-up self edge	GCT10WRZ2BU	48 x 120 x 29	100	314	35.72	\$1780	\$890
12 foot	self edge	GCT12WRZ2	48 x 144 x 29	100	328	35.10	\$1805	\$902.50
	bullnose edge	GCT12WRZ2BN	48 x 144 x 29	100	328	35.10	\$1805	\$902.50
	T-mold edge	GCT12WRZ2TM	48 x 144 x 29	250	97	35.10	\$1805	\$902.50
	built-up self edge	GCT12WRZ2BU	48 x 144 x 29	250	367	96	\$2004	\$1002
14 foot	self edge	GCT14WRZ2	48 x 168 x 29	92.5	441	39	\$2419	\$1209.50
	bullnose edge	GCT14WRZ2BN	48 x 168 x 29	92.5	441	39	\$2419	\$1209.50
	T-mold edge	GCT14WRZ2TM	48 x 168 x 29	92.5	441	39	\$2419	\$1209.50
	built-up self edge	GCT14WRZ2BU	48 x 168 x 29	92.5	447	42	\$2683	\$1341.50
16 foot	self edge	GCT16WRZ2	48 x 192 x 29	92.5	482	42.50	\$2514	\$1257
	bullnose edge	GCT16WRZ2BN	48 x 192 x 29	92.5	482	42.50	\$2514	\$1257
	T-mold edge	GCT16WRZ2TM	48 x 192 x 29	92.5	482	42.50	\$2514	\$1257
	built-up self edge	GCT16WRZ2BU	48 x 192 x 29	92.5	488	47	\$2774	\$1387
18 foot	self edge	GCT18WRZ2	48 x 216 x 29	100	523	54.40	\$3270	\$1635
	bullnose edge	GCT18WRZ2BN	48 x 216 x 29	100	523	54.40	\$3270	\$1635
	T-mold edge	GCT18WRZ2TM	48 x 216 x 29	100	523	54.40	\$3270	\$1635
	built-up self edge	GCT18WRZ2BU	48 x 216 x 29	100	550	59	\$3675	\$1837.50
20 foot	self edge	GCT20WRZ2	48 x 240 x 29	100	564	66.20	\$3317	\$1658.50
	bullnose edge	GCT20WRZ2BN	48 x 240 x 29	100	564	66.20	\$3317	\$1658.50
	T-mold edge	GCT20WRZ2TM	48 x 240 x 29	100	564	66.20	\$3317	\$1658.50
	built-up self edge	GCT20WRZ2BU	48 x 240 x 29	100	572	70.60	\$3724	\$1862
22 foot	self edge	GCT22WRZ2	48 x 264 x 29	100	604	68.20	\$3694	\$1847
	bullnose edge	GCT22WRZ2BN	48 x 264 x 29	100	604	68.20	\$3694	\$1847
	T-mold edge	GCT22WRZ2TM	48 x 264 x 29	100	604	68.20	\$3694	\$1847
	built-up self edge	GCT22WRZ2BU	48 x 264 x 29	100	612	73.68	\$4127	\$2063.50
24 foot	self edge	GCT24WRZ2	48 x 288 x 29	100	646	70.20	\$3790	\$1895
	bullnose edge	GCT24WRZ2BN	48 x 288 x 29	100	646	70.20	\$3790	\$1895
	T-mold edge	GCT24WRZ2TM	48 x 288 x 29	100	646	70.20	\$3790	\$1895
	built-up self edge	GCT24WRZ2BU	48 x 288 x 29	100	655	76.80	\$4216	\$2108

- All Drum Bases require approx. 125 lb. of sand in each base for adequate stability. Sand is not included.
- All tops over 144" are standard in two pieces. Woodgrain laminate finishes will NOT align where the two tops join.
- All tops 168", 192" and 216" are SHIPPED WITH 3 DRUM BASES.
- All tops 240", 264" and 288" are SHIPPED WITH 4 DRUM BASES.

Required Specifications

Finish
Base Finish
Edge Color, if applicable

Optional Specifications

Grommet
HP laminate

Accessories

Power Block

B BOARDROOM TABLES

RECTANGULAR TOP - ARCH BASE

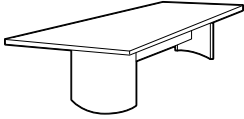

		MODEL#	DIMENSIONS	FREIGHT	CLASS	WT/LBS.	CUBIC FT.	LIST PRICE	HP ADD
			D x W x H						
5 foot	self edge	GCT5RA	30 x 60 x 29	85	131	9		\$1047	\$523.50
	bullnose edge	GCT5RABN	30 x 60 x 29	85	131	9		\$1047	\$523.50
	T-mold edge	GCT5RATM	30 x 60 x 29	85	131	9		\$1047	\$523.50
	built-up self edge	GCT5RABU	30 x 60 x 29	85	134	10		\$1188	\$594
6 foot	self edge	GCT6RA	36 x 72 x 29	125	157	24.64		\$1094	\$547
	bullnose edge	GCT6RABN	36 x 72 x 29	125	157	24.64		\$1094	\$547
	T-mold edge	GCT6RATM	36 x 72 x 29	70	157	8.24		\$1094	\$547
	built-up self edge	GCT6RABU	36 x 72 x 29	100	167	17.96		\$1300	\$650
7 foot	self edge	GCT7RA	44 x 84 x 29	92.5	203	19.43		\$1332	\$666
	bullnose edge	GCT7RABN	44 x 84 x 29	92.5	203	19.43		\$1332	\$666
	T-mold edge	GCT7RATM	44 x 84 x 29	92.5	203	19.43		\$1332	\$666
	built-up self edge	GCT7RABU	44 x 84 x 29	100	206	20.90		\$1509	\$754.50
8 foot	self edge	GCT8WRA	48 x 96 x 29	100	220	22.40		\$1332	\$666
	bullnose edge	GCT8WRABN	48 x 96 x 29	100	220	22.40		\$1332	\$666
	T-mold edge	GCT8WRATM	48 x 96 x 29	100	220	22.40		\$1332	\$666
	built-up self edge	GCT8WRABU	48 x 96 x 29	92.5	251	23.89		\$1509	\$754.50
10 foot	self edge	GCT10WRA	48 x 120 x 29	70	274	16.95		\$1520	\$760
	bullnose edge	GCT10WRABN	48 x 120 x 29	70	274	16.95		\$1520	\$760
	T-mold edge	GCT10WRATM	48 x 120 x 29	70	274	16.95		\$1520	\$760
	built-up self edge	GCT10WRABU	48 x 120 x 29	70	293	18.92		\$1792	\$896
12 foot	self edge	GCT12WRA	48 x 144 x 29	70	311	19.94		\$1757	\$878.50
	bullnose edge	GCT12WRABN	48 x 144 x 29	70	311	19.94		\$1757	\$878.50
	T-mold edge	GCT12WRATM	48 x 144 x 29	70	311	19.94		\$1757	\$878.50
	built-up self edge	GCT12WRABU	48 x 144 x 29	70	350	21.92		\$2051	\$1025.50
14 foot	self edge	GCT14WRA	48 x 168 x 29	70	423	26		\$2704	\$1352
	bullnose edge	GCT14WRABN	48 x 168 x 29	70	423	26		\$2704	\$1352
	T-mold edge	GCT14WRATM	48 x 168 x 29	70	423	26		\$2704	\$1352
	built-up self edge	GCT14WRABU	48 x 168 x 29	70	429	28		\$3013	\$1506.50
16 foot	self edge	GCT16WRA	48 x 192 x 29	70	474	30		\$2844	\$1422
	bullnose edge	GCT16WRABN	48 x 192 x 29	70	474	30		\$2844	\$1422
	T-mold edge	GCT16WRATM	48 x 192 x 29	70	474	30		\$2844	\$1422
	built-up self edge	GCT16WRABU	48 x 192 x 29	70	480	32		\$3180	\$1590
18 foot	self edge	GCT18WRA	48 x 216 x 29	70	525	31.92		\$3506	\$1753
	bullnose edge	GCT18WRABN	48 x 216 x 29	70	525	31.92		\$3506	\$1753
	T-mold edge	GCT18WRATM	48 x 216 x 29	70	525	31.92		\$3506	\$1753
	built-up self edge	GCT18WRABU	48 x 216 x 29	70	532	33.89		\$3917	\$1958.50
20 foot	self edge	GCT20WRA	48 x 240 x 29	70	576	33.89		\$3556	\$1778
	bullnose edge	GCT20WRABN	48 x 240 x 29	70	576	33.89		\$3556	\$1778
	T-mold edge	GCT20WRATM	48 x 240 x 29	70	576	33.89		\$3556	\$1778
	built-up self edge	GCT20WRABU	48 x 240 x 29	70	584	35.93		\$3955	\$1977.50
22 foot	self edge	GCT22WRA	48 x 264 x 29	70	626	36.89		\$3975	\$1987.50
	bullnose edge	GCT22WRABN	48 x 264 x 29	70	626	36.89		\$3975	\$1987.50
	T-mold edge	GCT22WRATM	48 x 264 x 29	70	626	36.89		\$3975	\$1987.50
	built-up self edge	GCT22WRABU	48 x 264 x 29	70	634	37.90		\$4445	\$2222.50
24 foot	self edge	GCT24WRA	48 x 288 x 29	70	678	40		\$4071	\$2035.50
	bullnose edge	GCT24WRABN	48 x 288 x 29	70	678	40		\$4071	\$2035.50
	T-mold edge	GCT24WRATM	48 x 288 x 29	70	678	40		\$4071	\$2035.50
	built-up self edge	GCT24WRABU	48 x 288 x 29	70	687	42		\$4536	\$2268

- All tops over 144" are standard in two pieces. Woodgrain laminate finishes will NOT align where the two tops join.
- All tops 168", 192", 216" and 240" are SHIPPED WITH 2 ARCH BASES AND 1 SLAB BASE.
- All tops 264" and 288" are SHIPPED WITH 2 ARCH BASES AND 2 SLAB BASES.

Required Specifications

Finish
Base Finish
Edge Color, if applicable

Optional Specifications

Grommet
HP laminate

Accessories

Power Block

RECTANGULAR TOP - 2 LEG BASE



	MODEL#	DIMENSIONS		FREIGHT	CLASS	WT/LBS.	CUBIC FT.	LIST PRICE	HP ADD
		D	W x H						
5 foot	self edge	GCT5R	30 x 60 x 29	125	88	13	\$924	\$462	
	bullnose edge	GCT5RBN	30 x 60 x 29	125	88	13	\$924	\$462	
	T-mold edge	GCT5RTM	30 x 60 x 29	125	88	13	\$924	\$462	
	built-up self edge	GCT5RBU	30 x 60 x 29	125	91	14	\$1032	\$516	
6 foot	self edge	GCT6R	36 x 72 x 29	125	115	15	\$1029	\$514.50	
	bullnose edge	GCT6RBN	36 x 72 x 29	92.5	152	15	\$1029	\$514.50	
	T-mold edge	GCT6RTM	36 x 72 x 29	92.5	152	15	\$1029	\$514.50	
	built-up self edge	GCT6RBU	36 x 72 x 29	92.5	162	16	\$1144	\$572	
7 foot	self edge	GCT7R	44 x 84 x 29	100	155	17	\$1189	\$594.50	
	bullnose edge	GCT7RBN	44 x 84 x 29	100	155	17	\$1189	\$594.50	
	T-mold edge	GCT7RTM	44 x 84 x 29	100	155	17	\$1189	\$594.50	
	built-up self edge	GCT7RBU	44 x 84 x 29	100	158	19.02	\$1333	\$666.50	
8 foot	self edge	GCT8WR	48 x 96 x 29	92.5	194	19.04	\$1189	\$594.50	
	bullnose edge	GCT8WRBN	48 x 96 x 29	100	180	19.02	\$1189	\$594.50	
	T-mold edge	GCT8WRTM	48 x 96 x 29	100	180	19.02	\$1189	\$594.50	
	built-up self edge	GCT8WRBU	48 x 96 x 29	92.5	211	21	\$1333	\$666.50	
10 foot	self edge	GCT10WR	48 x 120 x 29	92.5	214	20.93	\$1653	\$826.50	
	bullnose edge	GCT10WRBN	48 x 120 x 29	92.5	237	21	\$1653	\$826.50	
	T-mold edge	GCT10WRTM	48 x 120 x 29	92.5	237	21	\$1653	\$826.50	
	built-up self edge	GCT10WRBU	48 x 120 x 29	125	256	34.37	\$1849	\$924.50	
12 foot	self edge	GCT12WR	48 x 144 x 29	92.5	270	23	\$1859	\$929.50	
	bullnose edge	GCT12WRBN	48 x 144 x 29	85	270	21	\$1859	\$929.50	
	T-mold edge	GCT12WRTM	48 x 144 x 29	92.5	270	22.90	\$1859	\$929.50	
	built-up self edge	GCT12WRBU	48 x 144 x 29	85	309	24.91	\$2072	\$1036	
14 foot	self edge	GCT14WR	48 x 168 x 29	100	326	34	\$2134	\$1067	
	bullnose edge	GCT14WRBN	48 x 168 x 29	100	326	34	\$2134	\$1067	
	T-mold edge	GCT14WRTM	48 x 168 x 29	100	326	34	\$2134	\$1067	
	built-up self edge	GCT14WRBU	48 x 168 x 29	100	332	38	\$2358	\$1179	
16 foot	self edge	GCT16WR	48 x 192 x 29	100	367	38	\$2229	\$1114.50	
	bullnose edge	GCT16WRBN	48 x 192 x 29	100	367	38	\$2229	\$1114.50	
	T-mold edge	GCT16WRTM	48 x 192 x 29	100	367	38	\$2229	\$1114.50	
	built-up self edge	GCT16WRBU	48 x 192 x 29	100	373	40	\$2414	\$1207	
18 foot	self edge	GCT18WR	48 x 216 x 29	92.5	408	40	\$2655	\$1327.50	
	bullnose edge	GCT18WRBN	48 x 216 x 29	92.5	408	40	\$2655	\$1327.50	
	T-mold edge	GCT18WRTM	48 x 216 x 29	92.5	408	40	\$2655	\$1327.50	
	built-up self edge	GCT18WRBU	48 x 216 x 29	100	416	42	\$2962	\$1481	
20 foot	self edge	GCT20WR	48 x 240 x 29	92.5	449	42	\$2750	\$1375	
	bullnose edge	GCT20WRBN	48 x 240 x 29	92.5	449	42	\$2750	\$1375	
	T-mold edge	GCT20WRTM	48 x 240 x 29	92.5	449	42	\$2750	\$1375	
	built-up self edge	GCT20WRBU	48 x 240 x 29	92.5	457	44	\$3052	\$1526	
22 foot	self edge	GCT22WR	48 x 264 x 29	92.5	489	44	\$3033	\$1516.50	
	bullnose edge	GCT22WRBN	48 x 264 x 29	92.5	489	44	\$3033	\$1516.50	
	T-mold edge	GCT22WRTM	48 x 264 x 29	92.5	489	44	\$3033	\$1516.50	
	built-up self edge	GCT22WRBU	48 x 264 x 29	92.5	497	46	\$3414	\$1707	
24 foot	self edge	GCT24WR	48 x 288 x 29	92.5	531	46	\$3126	\$1563	
	bullnose edge	GCT24WRBN	48 x 288 x 29	92.5	531	46	\$3126	\$1563	
	T-mold edge	GCT24WRTM	48 x 288 x 29	92.5	531	46	\$3126	\$1563	
	built-up self edge	GCT24WRBU	48 x 288 x 29	92.5	540	48	\$3494	\$1747	

- All tops over 144" are standard in two pieces. Woodgrain laminate finishes will NOT align where the two tops join.
- All tops 120", 144", and 168" are SHIPPED WITH 3 LEG BASES.
- All tops 192" are SHIPPED WITH 4 LEG BASES.
- All tops 216", 240", 264" and 288" are SHIPPED WITH 6 LEG BASES.

Required Specifications

Finish
Base Finish
Edge Color, if applicable

Optional Specifications

Grommet
HP laminate

Accessories

Power Block

B BOARDROOM TABLES

RECTANGULAR TOP - TUBULAR BASE



	MODEL#	DIMENSIONS	FREIGHT CLASS	WT/LBS.	CUBIC FT.	LIST PRICE	HP ADD	
		D x W x H						
5 foot	self edge	GCR5R	30 x 60 x 29	150	94	21	\$953	\$476.50
	bullnose edge	GCR5RBN	30 x 60 x 29	150	94	21	\$953	\$476.50
	T-mold edge	GCR5RTM	30 x 60 x 29	150	94	21	\$953	\$476.50
	built-up self edge	GCR5RBU	30 x 60 x 29	150	97	23	\$1064	\$532
6 foot	self edge	GCR6R	36 x 72 x 29	150	107	23	\$1058	\$529
	bullnose edge	GCR6RBN	36 x 72 x 29	150	107	23	\$1058	\$529
	T-mold edge	GCR6RTM	36 x 72 x 29	150	107	23	\$1058	\$529
	built-up self edge	GCR6RBU	36 x 72 x 29	150	117	25	\$1178	\$589
7 foot	self edge	GCR7R	44 x 84 x 29	125	161	25	\$1219	\$609.50
	bullnose edge	GCR7RBN	44 x 84 x 29	125	161	25	\$1219	\$609.50
	T-mold edge	GCR7RTM	44 x 84 x 29	125	161	25	\$1219	\$609.50
	built-up self edge	GCR7RBU	44 x 84 x 29	125	164	27	\$1364	\$682
8 foot	self edge	GCR8WR	48 x 96 x 29	125	177	27	\$1219	\$609.50
	bullnose edge	GCR8WRBN	48 x 96 x 29	125	177	27	\$1219	\$609.50
	T-mold edge	GCR8WRTM	48 x 96 x 29	125	177	27	\$1219	\$609.50
	built-up self edge	GCR8WRBU	48 x 96 x 29	125	208	29	\$1364	\$682
10 foot	self edge	GCR10WR	48 x 120 x 29	125	221	28.92	\$1670	\$835
	bullnose edge	GCR10WRBN	48 x 120 x 29	125	221	28.92	\$1670	\$835
	T-mold edge	GCR10WRTM	48 x 120 x 29	125	221	29	\$1670	\$835
	built-up self edge	GCR10WRBU	48 x 120 x 29	125	239	32	\$1873	\$936.50
12 foot	self edge	GCR12WR	48 x 144 x 29	100	270	30.96	\$1881	\$940.50
	bullnose edge	GCR12WRBN	48 x 144 x 29	100	270	30.96	\$1881	\$940.50
	T-mold edge	GCR12WRTM	48 x 144 x 29	100	270	30.96	\$1881	\$940.50
	built-up self edge	GCR12WRBU	48 x 144 x 29	100	293	33.89	\$2100	\$1050
14 foot	self edge	GCR14WR	48 x 168 x 29	125	330	50	\$2162	\$1081
	bullnose edge	GCR14WRBN	48 x 168 x 29	125	330	50	\$2162	\$1081
	T-mold edge	GCR14WRTM	48 x 168 x 29	125	330	50	\$2162	\$1081
	built-up self edge	GCR14WRBU	48 x 168 x 29	125	336	54	\$2387	\$1193.50
16 foot	self edge	GCR16WR	48 x 192 x 29	125	371	54	\$2256	\$1128
	bullnose edge	GCR16WRBN	48 x 192 x 29	125	371	54	\$2256	\$1128
	T-mold edge	GCR16WRTM	48 x 192 x 29	125	371	54	\$2256	\$1128
	built-up self edge	GCR16WRBU	48 x 192 x 29	125	377	58	\$2478	\$1239
18 foot	self edge	GCR18WR	48 x 216 x 29	125	412	56	\$2673	\$1336.50
	bullnose edge	GCR18WRBN	48 x 216 x 29	125	412	56	\$2673	\$1336.50
	T-mold edge	GCR18WRTM	48 x 216 x 29	125	412	56	\$2673	\$1336.50
	built-up self edge	GCR18WRBU	48 x 216 x 29	125	419	60	\$2986	\$1493
20 foot	self edge	GCR20WR	48 x 240 x 29	125	453	58	\$2768	\$1384
	bullnose edge	GCR20WRBN	48 x 240 x 29	125	453	58	\$2768	\$1384
	T-mold edge	GCR20WRTM	48 x 240 x 29	125	453	58	\$2768	\$1384
	built-up self edge	GCR20WRBU	48 x 240 x 29	125	461	62	\$3086	\$1543
22 foot	self edge	GCR22WR	48 x 264 x 29	100	493	60	\$3080	\$1540
	bullnose edge	GCR22WRBN	48 x 264 x 29	100	493	60	\$3080	\$1540
	T-mold edge	GCR22WRTM	48 x 264 x 29	100	493	60	\$3080	\$1540
	built-up self edge	GCR22WRBU	48 x 264 x 29	125	501	64	\$3440	\$1720
24 foot	self edge	GCR24WR	48 x 288 x 29	100	535	62	\$3177	\$1588.50
	bullnose edge	GCR24WRBN	48 x 288 x 29	100	535	62	\$3177	\$1588.50
	T-mold edge	GCR24WRTM	48 x 288 x 29	100	535	62	\$3177	\$1588.50
	built-up self edge	GCR24WRBU	48 x 288 x 29	100	544	66	\$3530	\$1765

- All tops over 144" are standard in two pieces. Woodgrain laminate finishes will NOT align where the two tops join.
- All tops 120", 144", and 168" are SHIPPED WITH 3 TUBULAR BASES.
- All tops 192" are SHIPPED WITH 4 TUBULAR BASES.
- All tops 216", 240", 264" and 288" are SHIPPED WITH 6 TUBULAR BASES.

Required Specifications

Finish
Base Finish
Edge Color, if applicable

Optional Specifications

Grommet
HP laminate

Accessories

Power Block

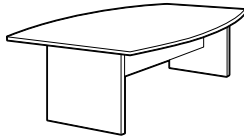
BOAT TOP - SLAB BASE

		MODEL#	DIMENSIONS	FREIGHT	CLASS	WT/LBS.	CUBIC FT.	LIST PRICE	HP ADD
			D x W x H						
5 foot	self edge	GCT5BX	30 x 60 x 29	70	131	6		\$785	\$392.50
	bullnose edge	GCT5BXBN	30 x 60 x 29	70	131	6		\$785	\$392.50
	T-mold edge	GCT5BXTM	30 x 60 x 29	70	131	7		\$785	\$392.50
	built-up self edge	GCT5BXBU	30 x 60 x 29	125	114	17		\$868	\$434
6 foot	self edge	GCT6BX	36 x 72 x 29	70	138	7.60		\$880	\$440
	bullnose edge	GCT6BXBN	36 x 72 x 29	70	138	7.60		\$880	\$440
	T-mold edge	GCT6BXTM	36 x 72 x 29	70	147	7.60		\$880	\$440
	built-up self edge	GCT6BXBU	36 x 72 x 29	70	157	8.90		\$981	\$490.50
7 foot	self edge	GCT7BX	44 x 84 x 29	70	199	9.94		\$1133	\$566.50
	bullnose edge	GCT7BXBN	44 x 84 x 29	70	199	9.94		\$1133	\$566.50
	T-mold edge	GCT7BXTM	44 x 84 x 29	70	199	9.94		\$1133	\$566.50
	built-up self edge	GCT7BXBU	44 x 84 x 29	70	203	11.95		\$1279	\$639.50
8 foot	self edge	GCT8WBX	48 x 96 x 29	70	218	11.29		\$1133	\$566.50
	bullnose edge	GCT8WBXBN	48 x 96 x 29	70	218	11.29		\$1133	\$566.50
	T-mold edge	GCT8WBXTM	48 x 96 x 29	70	218	11.29		\$1133	\$566.50
	built-up self edge	GCT8WBXBU	48 x 96 x 29	70	218	13.53		\$1279	\$639.50
10 foot	self edge	GCT10WBX2	48 x 120 x 29	70	249	13.53		\$1313	\$656.50
	bullnose edge	GCT10WBX2BN	48 x 120 x 29	70	249	13.53		\$1313	\$656.50
	T-mold edge	GCT10WBX2TM	48 x 120 x 29	70	249	13.53		\$1313	\$656.50
	built-up self edge	GCT10WBX2BU	48 x 120 x 29	70	294	16.20		\$1554	\$777
12 foot	self edge	GCT12WBX2	48 x 144 x 29	70	308	15.54		\$1541	\$770.50
	bullnose edge	GCT12WBX2BN	48 x 144 x 29	70	308	15.54		\$1541	\$770.50
	T-mold edge	GCT12WBX2TM	48 x 144 x 29	70	308	15.54		\$1541	\$770.50
	built-up self edge	GCT12WBX2BU	48 x 144 x 29	70	338	18.83		\$1809	\$904.50
14 foot	self edge	GCT14WBX2	48 x 168 x 29	65	419	18		\$2229	\$1114.50
	bullnose edge	GCT14WBX2BN	48 x 168 x 29	65	419	18		\$2229	\$1114.50
	T-mold edge	GCT14WBX2TM	48 x 168 x 29	65	419	18		\$2229	\$1114.50
	built-up self edge	GCT14WBX2BU	48 x 168 x 29	65	425	16		\$2488	\$1244
16 foot	self edge	GCT16WBX2	48 x 192 x 29	70	460	22.70		\$2323	\$1161.50
	bullnose edge	GCT16WBX2BN	48 x 192 x 29	70	460	22.70		\$2323	\$1161.50
	T-mold edge	GCT16WBX2TM	48 x 192 x 29	70	460	22.70		\$2323	\$1161.50
	built-up self edge	GCT16WBX2BU	48 x 192 x 29	70	466	27.20		\$2594	\$1297
18 foot	self edge	GCT18WBX2	48 x 216 x 29	70	521	24.60		\$2891	\$1445.50
	bullnose edge	GCT18WBX2BN	48 x 216 x 29	70	521	24.60		\$2891	\$1445.50
	T-mold edge	GCT18WBX2TM	48 x 216 x 29	70	521	24.60		\$2891	\$1445.50
	built-up self edge	GCT18WBX2BU	48 x 216 x 29	70	528	29.80		\$3241	\$1620.50
20 foot	self edge	GCT20WBX2	48 x 240 x 29	70	572	26.60		\$2937	\$1468.50
	bullnose edge	GCT20WBX2BN	48 x 240 x 29	70	572	26.60		\$2937	\$1468.50
	T-mold edge	GCT20WBX2TM	48 x 240 x 29	70	572	26.60		\$2937	\$1468.50
	built-up self edge	GCT20WBX2BU	48 x 240 x 29	70	580	32.50		\$3288	\$1644
22 foot	self edge	GCT22WBX2	48 x 264 x 29	70	612	28.90		\$3410	\$1705
	bullnose edge	GCT22WBX2BN	48 x 264 x 29	70	612	28.90		\$3410	\$1705
	T-mold edge	GCT22WBX2TM	48 x 264 x 29	70	612	28.90		\$3410	\$1705
	built-up self edge	GCT22WBX2BU	48 x 264 x 29	70	620	35.10		\$3765	\$1882.50
24 foot	self edge	GCT24WBX2	48 x 288 x 29	70	673	31.20		\$3506	\$1753
	bullnose edge	GCT24WBX2BN	48 x 288 x 29	70	673	31.20		\$3506	\$1753
	T-mold edge	GCT24WBX2TM	48 x 288 x 29	70	673	31.20		\$3506	\$1753
	built-up self edge	GCT24WBX2BU	48 x 288 x 29	70	682	37.70		\$3878	\$1939

- All tops over 144" are standard in two pieces. Woodgrain laminate finishes will NOT align where the two tops join.
- All tops 168", 192", 216" and 240" are SHIPPED WITH 3 SLAB BASES.
- All tops 264" and 288" are SHIPPED WITH 4 SLAB BASES.

Required Specifications

Finish
Base Finish
Edge Color, if applicable

Optional Specifications

Grommet
HP laminate

Accessories

Power Block

B BOARDROOM TABLES

BOAT TOP - DRUM BASE

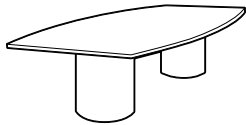

		MODEL#	DIMENSIONS	FREIGHT CLASS	WT/LBS.	CUBIC FT.	LIST PRICE	HP ADD
			D x W x H					
6 foot	self edge	GCT6BZ	36 x 72 x 29	100	162	17.50	\$1189	\$594.50
	bullnose edge	GCT6BZBN	36 x 72 x 29	100	153	17.50	\$1189	\$594.50
	T-mold edge	GCT6BZTM	36 x 72 x 29	100	162	17.50	\$1189	\$594.50
	built-up self edge	GCT6BZBU	36 x 72 x 29	100	172	18.90	\$1331	\$665.50
7 foot	self edge	GCT7BZ	44 x 84 x 29	92.5	196	19.40	\$1351	\$675.50
	bullnose edge	GCT7BZBN	44 x 84 x 29	92.5	196	19.40	\$1351	\$675.50
	T-mold edge	GCT7BZTM	44 x 84 x 29	92.5	196	19.40	\$1351	\$675.50
	built-up self edge	GCT7BZBU	44 x 84 x 29	100	199	21.20	\$1519	\$759.50
8 foot	self edge	GCT8WBZ	48 x 96 x 29	92.5	219	21.20	\$1378	\$689
	bullnose edge	GCT8WBZBN	48 x 96 x 29	92.5	219	21.20	\$1378	\$689
	T-mold edge	GCT8WBZTM	48 x 96 x 29	92.5	219	21.20	\$1378	\$689
	built-up self edge	GCT8WBZBU	48 x 96 x 29	92.5	250	23.50	\$1519	\$759.50
10 foot	self edge	GCT10WBZ2	48 x 120 x 29	100	272	33.30	\$1615	\$807.50
	bullnose edge	GCT10WBZ2BN	48 x 120 x 29	100	272	33.30	\$1615	\$807.50
	T-mold edge	GCT10WBZ2TM	48 x 120 x 29	100	272	33.22	\$1615	\$807.50
	built-up self edge	GCT10WBZ2BU	48 x 120 x 29	100	317	35.70	\$1780	\$890
12 foot	self edge	GCT12WBZ2	48 x 144 x 29	100	327	35.30	\$1805	\$902.50
	bullnose edge	GCT12WBZ2BN	48 x 144 x 29	100	327	35.30	\$1805	\$902.50
	T-mold edge	GCT12WBZ2TM	48 x 144 x 29	100	327	35.30	\$1805	\$902.50
	built-up self edge	GCT12WBZ2BU	48 x 144 x 29	100	357	38.40	\$2004	\$1002
14 foot	self edge	GCT14WBZ2	48 x 168 x 29	92.5	441	39	\$2419	\$1209.50
	bullnose edge	GCT14WBZ2BN	48 x 168 x 29	92.5	441	39	\$2419	\$1209.50
	T-mold edge	GCT14WBZ2TM	48 x 168 x 29	92.5	441	39	\$2419	\$1209.50
	built-up self edge	GCT14WBZ2BU	48 x 168 x 29	92.5	447	42	\$2683	\$1341.50
16 foot	self edge	GCT16WBZ2	48 x 192 x 29	92.5	482	42.52	\$2514	\$1257
	bullnose edge	GCT16WBZ2BN	48 x 192 x 29	92.5	482	42.52	\$2514	\$1257
	T-mold edge	GCT16WBZ2TM	48 x 192 x 29	92.5	482	42.52	\$2514	\$1257
	built-up self edge	GCT16WBZ2BU	48 x 192 x 29	92.5	488	47	\$2774	\$1387
18 foot	self edge	GCT18WBZ2	48 x 216 x 29	100	523	54.40	\$3270	\$1635
	bullnose edge	GCT18WBZ2BN	48 x 216 x 29	100	523	54.40	\$3270	\$1635
	T-mold edge	GCT18WBZ2TM	48 x 216 x 29	100	523	54.40	\$3270	\$1635
	built-up self edge	GCT18WBZ2BU	48 x 216 x 29	100	550	59	\$3675	\$1837.50
20 foot	self edge	GCT20WBZ2	48 x 240 x 29	100	564	66.20	\$3317	\$1658.50
	bullnose edge	GCT20WBZ2BN	48 x 240 x 29	100	564	66.20	\$3317	\$1658.50
	T-mold edge	GCT20WBZ2TM	48 x 240 x 29	100	564	66.20	\$3317	\$1658.50
	built-up self edge	GCT20WBZ2BU	48 x 240 x 29	100	572	70.60	\$3724	\$1862
22 foot	self edge	GCT22WBZ2	48 x 264 x 29	100	604	68.20	\$3694	\$1847
	bullnose edge	GCT22WBZ2BN	48 x 264 x 29	100	604	68.20	\$3694	\$1847
	T-mold edge	GCT22WBZ2TM	48 x 264 x 29	100	604	68.20	\$3694	\$1847
	built-up self edge	GCT22WBZ2BU	48 x 264 x 29	100	612	73.68	\$4127	\$2063.50
24 foot	self edge	GCT24WBZ2	48 x 288 x 29	100	646	70.20	\$3790	\$1895
	bullnose edge	GCT24WBZ2BN	48 x 288 x 29	100	646	70.20	\$3790	\$1895
	T-mold edge	GCT24WBZ2TM	48 x 288 x 29	100	646	70.20	\$3790	\$1895
	built-up self edge	GCT24WBZ2BU	48 x 288 x 29	100	655	76.80	\$4216	\$2108

- All Drum Bases require approx. 125 lb. of sand in each base for adequate stability. Sand is not included.
- All tops over 144" are standard in two pieces. Woodgrain laminate finishes will NOT align where the two tops join.
- All tops 168", 192" and 216" are SHIPPED WITH 3 DRUM BASES.
- All tops 240", 264" and 288" are SHIPPED WITH 4 DRUM BASES.

Required Specifications

Finish
Base Finish
Edge Color, if applicable

Optional Specifications

Grommet
HP laminate

Accessories

Power Block

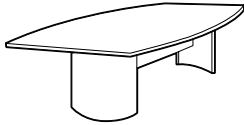
BOAT TOP - ARCH BASE

	MODEL#	DIMENSIONS	FREIGHT	CLASS	WT/LBS.	CUBIC FT.	LIST PRICE	HP ADD
		D x W x H						
5 foot	self edge	GCT5BA	30 x 60 x 29	85	131	9	\$1047	\$523.50
	bullnose edge	GCT5BABN	30 x 60 x 29	85	131	9	\$1047	\$523.50
	T-mold edge	GCT5BATM	30 x 60 x 29	85	131	9	\$1047	\$523.50
	built-up self edge	GCT5BABU	30 x 60 x 29	85	134	10	\$1188	\$594
6 foot	self edge	GCT6BA	36 x 72 x 29	85	152	11	\$1094	\$547
	bullnose edge	GCT6BABN	36 x 72 x 29	85	152	11	\$1094	\$547
	T-mold edge	GCT6BATM	36 x 72 x 29	85	152	11	\$1094	\$547
	built-up self edge	GCT6BABU	36 x 72 x 29	85	162	12	\$1300	\$650
7 foot	self edge	GCT7BA	44 x 84 x 29	70	203	12.96	\$1332	\$666
	bullnose edge	GCT7BABN	44 x 84 x 29	70	203	12.96	\$1332	\$666
	T-mold edge	GCT7BATM	44 x 84 x 29	70	203	12.96	\$1332	\$666
	built-up self edge	GCT7BABU	44 x 84 x 29	85	206	13.98	\$1509	\$754.50
8 foot	self edge	GCT8WBA	48 x 96 x 29	70	228	14.97	\$1332	\$666
	bullnose edge	GCT8WBABN	48 x 96 x 29	85	220	14.97	\$1332	\$666
	T-mold edge	GCT8WBATM	48 x 96 x 29	85	220	14.97	\$1332	\$666
	built-up self edge	GCT8WBABU	48 x 96 x 29	85	220	15.96	\$1509	\$754.50
10 foot	self edge	GCT10WBA	48 x 120 x 29	85	251	16.95	\$1520	\$760
	bullnose edge	GCT10WBABN	48 x 120 x 29	85	251	16.95	\$1520	\$760
	T-mold edge	GCT10WBATM	48 x 120 x 29	85	251	16.95	\$1520	\$760
	built-up self edge	GCT10WBABU	48 x 120 x 29	70	296	18.92	\$1792	\$896
12 foot	self edge	GCT12WBA	48 x 144 x 29	70	306	20	\$1757	\$878.50
	bullnose edge	GCT12WBABN	48 x 144 x 29	70	310	19.94	\$1757	\$878.50
	T-mold edge	GCT12WBATM	48 x 144 x 29	70	310	19.94	\$1757	\$878.50
	built-up self edge	GCT12WBABU	48 x 144 x 29	70	340	21.89	\$2051	\$1025.50
14 foot	self edge	GCT14WBA	48 x 168 x 29	70	423	25.93	\$2704	\$1352
	bullnose edge	GCT14WBABN	48 x 168 x 29	70	423	25.93	\$2704	\$1352
	T-mold edge	GCT14WBATM	48 x 168 x 29	70	423	25.93	\$2704	\$1352
	built-up self edge	GCT14WBABU	48 x 168 x 29	70	429	27.90	\$3013	\$1506.50
16 foot	self edge	GCT16WBA	48 x 192 x 29	70	474	29.94	\$2844	\$1422
	bullnose edge	GCT16WBABN	48 x 192 x 29	70	474	29.94	\$2844	\$1422
	T-mold edge	GCT16WBATM	48 x 192 x 29	70	474	29.94	\$2844	\$1422
	built-up self edge	GCT16WBABU	48 x 192 x 29	70	480	31.92	\$3180	\$1590
18 foot	self edge	GCT18WBA	48 x 216 x 29	70	525	31.92	\$3506	\$1753
	bullnose edge	GCT18WBABN	48 x 216 x 29	70	525	31.92	\$3506	\$1753
	T-mold edge	GCT18WBATM	48 x 216 x 29	70	525	31.92	\$3506	\$1753
	built-up self edge	GCT18WBABU	48 x 216 x 29	70	532	33.89	\$3917	\$1958.50
20 foot	self edge	GCT20WBA	48 x 240 x 29	70	576	33.89	\$3556	\$1778
	bullnose edge	GCT20WBABN	48 x 240 x 29	70	576	33.89	\$3556	\$1778
	T-mold edge	GCT20WBATM	48 x 240 x 29	70	576	33.89	\$3556	\$1778
	built-up self edge	GCT20WBABU	48 x 240 x 29	70	584	35.93	\$3955	\$1977.50
22 foot	self edge	GCT22WBA	48 x 264 x 29	70	626	36.89	\$3975	\$1987.50
	bullnose edge	GCT22WBABN	48 x 264 x 29	70	626	36.89	\$3975	\$1987.50
	T-mold edge	GCT22WBATM	48 x 264 x 29	70	626	36.89	\$3975	\$1987.50
	built-up self edge	GCT22WBABU	48 x 264 x 29	70	634	37.90	\$4445	\$2222.50
24 foot	self edge	GCT24WBA	48 x 288 x 29	70	678	40	\$4071	\$2035.50
	bullnose edge	GCT24WBABN	48 x 288 x 29	70	678	40	\$4071	\$2035.50
	T-mold edge	GCT24WBATM	48 x 288 x 29	70	678	40	\$4071	\$2035.50
	built-up self edge	GCT24WBABU	48 x 288 x 29	65	687	25.10	\$4536	\$2268

- All tops over 144" are standard in two pieces. Woodgrain laminate finishes will NOT align where the two tops join.
- All tops 168", 192", 216" and 240" are SHIPPED WITH 2 ARCH BASES AND 1 SLAB BASE.
- All tops 264" and 288" are SHIPPED WITH 2 ARCH BASES AND 2 SLAB BASES.

Required Specifications

Finish
Base Finish
Edge Color, if applicable

Optional Specifications

Grommet
HP laminate

Accessories

Power Block

B BOARDROOM TABLES

BOAT TOP - 2 LEG BASE



	MODEL#	DIMENSIONS	FREIGHT CLASS	WT/LBS.	CUBIC FT.	LIST PRICE	HP ADD	
		D x W x H						
5 foot	self edge	GCT5B	30 x 60 x 29	125	88	13	\$924	\$462
	bullnose edge	GCT5BBN	30 x 60 x 29	125	88	13	\$924	\$462
	T-mold edge	GCT5BTM	30 x 60 x 29	125	88	13	\$924	\$462
	built-up self edge	GCT5BBU	30 x 60 x 29	125	91	14	\$1032	\$516
6 foot	self edge	GCT6B	36 x 72 x 29	100	123	15	\$1029	\$514.50
	bullnose edge	GCT6BBN	36 x 72 x 29	125	114	15	\$1029	\$514.50
	T-mold edge	GCT6BTM	36 x 72 x 29	100	123	15	\$1029	\$514.50
	built-up self edge	GCT6BBU	36 x 72 x 29	100	133	16	\$1144	\$572
7 foot	self edge	GCT7B	44 x 84 x 29	100	155	16.98	\$1189	\$594.50
	bullnose edge	GCT7BBN	44 x 84 x 29	100	155	16.98	\$1189	\$594.50
	T-mold edge	GCT7BTM	44 x 84 x 29	100	155	16.98	\$1189	\$594.50
	built-up self edge	GCT7BBU	44 x 84 x 29	100	158	18.98	\$1333	\$666.50
8 foot	self edge	GCT8WB	48 x 96 x 29	100	188	19	\$1189	\$594.50
	bullnose edge	GCT8WBBN	48 x 96 x 29	100	180	19	\$1189	\$594.50
	T-mold edge	GCT8WBTM	48 x 96 x 29	100	180	18.98	\$1189	\$594.50
	built-up self edge	GCT8WBBU	48 x 96 x 29	100	180	21	\$1333	\$666.50
10 foot	self edge	GCT10WB	48 x 120 x 29	92.5	214	21	\$1653	\$826.50
	bullnose edge	GCT10WBBN	48 x 120 x 29	92.5	214	20.98	\$1653	\$826.50
	T-mold edge	GCT10WBTM	48 x 120 x 29	92.5	214	20.93	\$1653	\$826.50
	built-up self edge	GCT10WBBU	48 x 120 x 29	92.5	259	22.93	\$1849	\$924.50
12 foot	self edge	GCT12WB	48 x 144 x 29	92.5	265	22.80	\$1859	\$929.50
	bullnose edge	GCT12WBBN	48 x 144 x 29	92.5	269	22.69	\$1859	\$929.50
	T-mold edge	GCT12WBTM	48 x 144 x 29	92.5	269	22.69	\$1859	\$929.50
	built-up self edge	GCT12WBBU	48 x 144 x 29	92.5	299	25.69	\$2073	\$1036.50
14 foot	self edge	GCT14WB	48 x 168 x 29	100	326	34	\$2134	\$1067
	bullnose edge	GCT14WBBN	48 x 168 x 29	100	326	34	\$2134	\$1067
	T-mold edge	GCT14WBTM	48 x 168 x 29	100	326	34	\$2134	\$1067
	built-up self edge	GCT14WBBU	48 x 168 x 29	100	332	38	\$2358	\$1179
16 foot	self edge	GCT16WB	48 x 192 x 29	100	367	38	\$2229	\$1114.50
	bullnose edge	GCT16WBBN	48 x 192 x 29	100	367	38	\$2229	\$1114.50
	T-mold edge	GCT16WBTM	48 x 192 x 29	100	367	38	\$2229	\$1114.50
	built-up self edge	GCT16WBBU	48 x 192 x 29	100	373	40	\$2414	\$1207
18 foot	self edge	GCT18WB	48 x 216 x 29	92.5	408	40	\$2655	\$1327.50
	bullnose edge	GCT18WBBN	48 x 216 x 29	92.5	408	40	\$2655	\$1327.50
	T-mold edge	GCT18WBTM	48 x 216 x 29	92.5	408	40	\$2655	\$1327.50
	built-up self edge	GCT18WBBU	48 x 216 x 29	100	416	42	\$2962	\$1481
20 foot	self edge	GCT20WB	48 x 240 x 29	92.5	449	42	\$2750	\$1375
	bullnose edge	GCT20WBBN	48 x 240 x 29	92.5	449	42	\$2750	\$1375
	T-mold edge	GCT20WBTM	48 x 240 x 29	92.5	449	42	\$2750	\$1375
	built-up self edge	GCT20WBBU	48 x 240 x 29	92.5	457	44	\$3052	\$1526
22 foot	self edge	GCT22WB	48 x 264 x 29	92.5	489	44	\$3033	\$1516.50
	bullnose edge	GCT22WBBN	48 x 264 x 29	92.5	489	44	\$3033	\$1516.50
	T-mold edge	GCT22WBTM	48 x 264 x 29	92.5	489	44	\$3033	\$1516.50
	built-up self edge	GCT22WBBU	48 x 264 x 29	92.5	497	46	\$3414	\$1707
24 foot	self edge	GCT24WB	48 x 288 x 29	92.5	531	46	\$3126	\$1563
	bullnose edge	GCT24WBBN	48 x 288 x 29	92.5	531	46	\$3126	\$1563
	T-mold edge	GCT24WBTM	48 x 288 x 29	92.5	531	46	\$3126	\$1563
	built-up self edge	GCT24WBBU	48 x 288 x 29	92.5	540	48	\$3494	\$1747

- All tops over 144" are standard in two pieces. Woodgrain laminate finishes will NOT align where the two tops join.
- All tops 120", 144", and 168" are SHIPPED WITH 3 LEG BASES.
- All tops 192" are SHIPPED WITH 4 LEG BASES.
- All tops 216", 240", 264" and 288" are SHIPPED WITH 6 LEG BASES.

Required Specifications

Finish
Base Finish
Edge Color, if applicable

Optional Specifications

Grommet
HP laminate

Accessories

Power Block

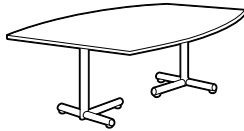
BOAT TOP - TUBULAR BASE

	MODEL#	DIMENSIONS	FREIGHT CLASS	WT/LBS.	CUBIC FT.	LIST PRICE	HP ADD
		D x W x H					
5 foot	self edge	GCR5B	30 x 60 x 29	150	94	21	\$953 \$476.50
	bullnose edge	GCR5BBN	30 x 60 x 29	150	94	21	\$953 \$476.50
	T-mold edge	GCR5BTM	30 x 60 x 29	150	94	21	\$953 \$476.50
	built-up self edge	GCR5BBU	30 x 60 x 29	150	97	23	\$1064 \$532
6 foot	self edge	GCR6B	36 x 72 x 29	150	107	23	\$1058 \$529
	bullnose edge	GCR6BBN	36 x 72 x 29	150	107	23	\$1058 \$529
	T-mold edge	GCR6BTM	36 x 72 x 29	150	107	23	\$1058 \$529
	built-up self edge	GCR6BBU	36 x 72 x 29	150	117	25	\$1178 \$589
7 foot	self edge	GCR7B	44 x 84 x 29	125	161	25	\$1219 \$609.50
	bullnose edge	GCR7BBN	44 x 84 x 29	125	161	25	\$1219 \$609.50
	T-mold edge	GCR7BTM	44 x 84 x 29	125	161	25	\$1219 \$609.50
	built-up self edge	GCR7BBU	44 x 84 x 29	150	164	29	\$1364 \$682
8 foot	self edge	GCR8WB	48 x 96 x 29	125	184	27	\$1219 \$609.50
	bullnose edge	GCR8WBBN	48 x 96 x 29	125	177	27	\$1219 \$609.50
	T-mold edge	GCR8WBTM	48 x 96 x 29	125	177	27	\$1219 \$609.50
	built-up self edge	GCR8WBBU	48 x 96 x 29	125	208	29	\$1364 \$682
10 foot	self edge	GCR10WB	48 x 120 x 29	125	221	29	\$1670 \$835
	bullnose edge	GCR10WBBN	48 x 120 x 29	125	221	29	\$1670 \$835
	T-mold edge	GCR10WBTM	48 x 120 x 29	125	221	29	\$1670 \$835
	built-up self edge	GCR10WBBU	48 x 120 x 29	125	239	32	\$1873 \$936.50
12 foot	self edge	GCR12WB	48 x 144 x 29	100	270	31	\$1881 \$940.50
	bullnose edge	GCR12WBBN	48 x 144 x 29	100	270	31	\$1881 \$940.50
	T-mold edge	GCR12WBTM	48 x 144 x 29	100	270	30.78	\$1881 \$940.50
	built-up self edge	GCR12WBBU	48 x 144 x 29	100	293	34	\$2100 \$1050
14 foot	self edge	GCR14WB	48 x 168 x 29	125	330	50	\$2162 \$1081
	bullnose edge	GCR14WBBN	48 x 168 x 29	125	330	50	\$2162 \$1081
	T-mold edge	GCR14WBTM	48 x 168 x 29	125	330	50	\$2162 \$1081
	built-up self edge	GCR14WBBU	48 x 168 x 29	125	336	54	\$2387 \$1193.50
16 foot	self edge	GCR16WB	48 x 192 x 29	125	371	54	\$2256 \$1128
	bullnose edge	GCR16WBBN	48 x 192 x 29	125	371	54	\$2256 \$1128
	T-mold edge	GCR16WBTM	48 x 192 x 29	125	371	54	\$2256 \$1128
	built-up self edge	GCR16WBBU	48 x 192 x 29	125	377	58	\$2478 \$1239
18 foot	self edge	GCR18WB	48 x 216 x 29	125	412	56	\$2673 \$1336.50
	bullnose edge	GCR18WBBN	48 x 216 x 29	125	412	56	\$2673 \$1336.50
	T-mold edge	GCR18WBTM	48 x 216 x 29	125	412	56	\$2673 \$1336.50
	built-up self edge	GCR18WBBU	48 x 216 x 29	125	419	60	\$2986 \$1493
20 foot	self edge	GCR20WB	48 x 240 x 29	125	453	58	\$2768 \$1384
	bullnose edge	GCR20WBBN	48 x 240 x 29	125	453	58	\$2768 \$1384
	T-mold edge	GCR20WBTM	48 x 240 x 29	125	453	58	\$2768 \$1384
	built-up self edge	GCR20WBBU	48 x 240 x 29	125	461	62	\$3086 \$1543
22 foot	self edge	GCR22WB	48 x 264 x 29	100	493	60	\$3080 \$1540
	bullnose edge	GCR22WBBN	48 x 264 x 29	100	493	60	\$3080 \$1540
	T-mold edge	GCR22WBTM	48 x 264 x 29	100	493	60	\$3080 \$1540
	built-up self edge	GCR22WBBU	48 x 264 x 29	125	501	64	\$3440 \$1720
24 foot	self edge	GCR24WB	48 x 288 x 29	100	535	62	\$3177 \$1588.50
	bullnose edge	GCR24WBBN	48 x 288 x 29	100	535	62	\$3177 \$1588.50
	T-mold edge	GCR24WBTM	48 x 288 x 29	100	535	62	\$3177 \$1588.50
	built-up self edge	GCR24WBBU	48 x 288 x 29	100	544	66	\$3530 \$1765

- All tops over 144" are standard in two pieces. Woodgrain laminate finishes will NOT align where the two tops join.
- All tops 120", 144", and 168" are SHIPPED WITH 3 TUBULAR BASES.
- All tops 192" are SHIPPED WITH 4 TUBULAR BASES.
- All tops 216", 240", 264" and 288" are SHIPPED WITH 6 TUBULAR BASES.

Required Specifications

Finish
Base Finish
Edge Color, if applicable

Optional Specifications

Grommet
HP laminate

Accessories

Power Block

B BOARDROOM TABLES

RACETRACK TOP - SLAB BASE

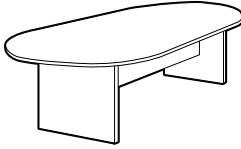

	MODEL#	DIMENSIONS	FREIGHT CLASS	WT/LBS.	CUBIC FT.	LIST PRICE	HP ADD
		D x W x H					
5 foot	self edge	GRT5X	30 x 60 x 29	70	131	6	\$785 \$392.50
	bullnose edge	GRT5XBN	30 x 60 x 29	70	131	6	\$785 \$392.50
	T-mold edge	GRT5XTM	30 x 60 x 29	70	131	6	\$785 \$392.50
	built-up self edge	GRT5XBU	30 x 60 x 29	70	134	7	\$868 \$434
6 foot	self edge	GRT6X	36 x 72 x 29	70	135	7.60	\$880 \$440
	bullnose edge	GRT6XBN	36 x 72 x 29	70	143	7.60	\$880 \$440
	T-mold edge	GRT6XTM	36 x 72 x 29	70	143	7.60	\$880 \$440
	built-up self edge	GRT6XBU	36 x 72 x 29	70	160	8.90	\$981 \$490.50
7 foot	self edge	GRT7X	44 x 84 x 29	70	199	9.94	\$1133 \$566.50
	bullnose edge	GRT7XBN	44 x 84 x 29	70	199	9.97	\$1133 \$566.50
	T-mold edge	GRT7XTM	44 x 84 x 29	70	199	9.94	\$1133 \$566.50
	built-up self edge	GRT7XBU	44 x 84 x 29	70	203	11.95	\$1279 \$639.50
8 foot	self edge	GRT8WX	48 x 96 x 29	70	216	11.29	\$1133 \$566.50
	bullnose edge	GRT8WXBN	48 x 96 x 29	70	218	11.29	\$1133 \$566.50
	T-mold edge	GRT8WXTM	48 x 96 x 29	70	216	11.29	\$1133 \$566.50
	built-up self edge	GRT8WXBU	48 x 96 x 29	70	242	13.53	\$1279 \$639.50
10 foot	self edge	GRT10WX2	48 x 120 x 29	70	280	13.53	\$1313 \$656.50
	bullnose edge	GRT10WX2BN	48 x 120 x 29	70	266	13.53	\$1313 \$656.50
	T-mold edge	GRT10WX2TM	48 x 120 x 29	70	256	13.53	\$1313 \$656.50
	built-up self edge	GRT10WX2BU	48 x 120 x 29	70	289	16.20	\$1554 \$777
12 foot	self edge	GRT12WX2	48 x 144 x 29	70	210	12.54	\$1541 \$770.50
	bullnose edge	GRT12WX2BN	48 x 144 x 29	65	307	12.54	\$1541 \$770.50
	T-mold edge	GRT12WX2TM	48 x 144 x 29	65	307	12.54	\$1541 \$770.50
	built-up self edge	GRT12WX2BU	48 x 144 x 29	70	340	18.83	\$1809 \$904.50
14 foot	self edge	GRT14WX2	48 x 168 x 29	65	419	18	\$2229 \$1114.50
	bullnose edge	GRT14WX2BN	48 x 168 x 29	65	419	18	\$2229 \$1114.50
	T-mold edge	GRT14WX2TM	48 x 168 x 29	65	419	18	\$2229 \$1114.50
	built-up self edge	GRT14WX2BU	48 x 168 x 29	70	425	20	\$2488 \$1244
16 foot	self edge	GRT16WX2	48 x 192 x 29	70	460	22.70	\$2323 \$1161.50
	bullnose edge	GRT16WX2BN	48 x 192 x 29	70	460	22.70	\$2323 \$1161.50
	T-mold edge	GRT16WX2TM	48 x 192 x 29	70	460	22.70	\$2323 \$1161.50
	built-up self edge	GRT16WX2BU	48 x 192 x 29	70	466	27.20	\$2594 \$1297
18 foot	self edge	GRT18WX2	48 x 216 x 29	70	521	24.60	\$2891 \$1445.50
	bullnose edge	GRT18WX2BN	48 x 216 x 29	70	521	24.60	\$2891 \$1445.50
	T-mold edge	GRT18WX2TM	48 x 216 x 29	70	521	24.60	\$2891 \$1445.50
	built-up self edge	GRT18WX2BU	48 x 216 x 29	70	528	29.80	\$3241 \$1620.50
20 foot	self edge	GRT20WX2	48 x 240 x 29	70	572	26.60	\$2937 \$1468.50
	bullnose edge	GRT20WX2BN	48 x 240 x 29	70	572	26.60	\$2937 \$1468.50
	T-mold edge	GRT20WX2TM	48 x 240 x 29	70	572	26.60	\$2937 \$1468.50
	built-up self edge	GRT20WX2BU	48 x 240 x 29	70	580	32.50	\$3288 \$1644
22 foot	self edge	GRT22WX2	48 x 264 x 29	70	612	28.90	\$3410 \$1705
	bullnose edge	GRT22WX2BN	48 x 264 x 29	70	612	28.90	\$3410 \$1705
	T-mold edge	GRT22WX2TM	48 x 264 x 29	70	612	28.90	\$3410 \$1705
	built-up self edge	GRT22WX2BU	48 x 264 x 29	70	620	35.10	\$3765 \$1882.50
24 foot	self edge	GRT24WX2	48 x 288 x 29	70	673	31.20	\$3506 \$1753
	bullnose edge	GRT24WX2BN	48 x 288 x 29	70	673	31.20	\$3506 \$1753
	T-mold edge	GRT24WX2TM	48 x 288 x 29	70	673	31.20	\$3506 \$1753
	built-up self edge	GRT24WX2BU	48 x 288 x 29	70	682	37.70	\$3878 \$1939

- All tops over 144" are standard in two pieces. Woodgrain laminate finishes will NOT align where the two tops join.
- All tops 168", 192", 216" and 240" are SHIPPED WITH 3 SLAB BASES.
- All tops 264" and 288" are SHIPPED WITH 4 SLAB BASES.

Required Specifications

Finish
Base Finish
Edge Color, if applicable

Optional Specifications

Grommet
HP laminate

Accessories

Power Block

RACETRACK TOP - DRUM BASE

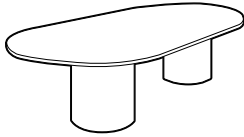

	MODEL#	DIMENSIONS	FREIGHT CLASS	WT/LBS.	CUBIC FT.	LIST PRICE	HP ADD
		D x W x H					
6 foot	self edge	GRT6Z	36 x 72 x 29	100	150	17.50	\$1189 \$594.50
	bullnose edge	GRT6ZBN	36 x 72 x 29	100	158	17.50	\$1189 \$594.50
	T-mold edge	GRT6ZTM	36 x 72 x 29	100	158	17.50	\$1189 \$594.50
	built-up self edge	GRT6ZBU	36 x 72 x 29	100	175	18.80	\$1331 \$665.50
7 foot	self edge	GRT7Z	44 x 84 x 29	92.5	196	19.40	\$1378 \$689
	bullnose edge	GRT7ZBN	44 x 84 x 29	92.5	196	19.40	\$1378 \$689
	T-mold edge	GRT7ZTM	44 x 84 x 29	92.5	196	19.40	\$1378 \$689
	built-up self edge	GRT7ZBU	44 x 84 x 29	100	199	21.20	\$1519 \$759.50
8 foot	self edge	GRT8WZ	48 x 96 x 29	92.5	217	21.26	\$1378 \$689
	bullnose edge	GRT8WZBN	48 x 96 x 29	92.5	219	21.26	\$1378 \$689
	T-mold edge	GRT8WZTM	48 x 96 x 29	92.5	217	21.26	\$1378 \$689
	built-up self edge	GRT8WZBU	48 x 96 x 29	92.5	243	23.50	\$1519 \$759.50
10 foot	self edge	GRT10WZ2	48 x 120 x 29	100	313	33.14	\$1615 \$807.50
	bullnose edge	GRT10WZ2BN	48 x 120 x 29	100	289	33.14	\$1615 \$807.50
	T-mold edge	GRT10WZ2TM	48 x 120 x 29	100	279	33.14	\$1615 \$807.50
	built-up self edge	GRT10WZ2BU	48 x 120 x 29	100	312	35.70	\$1780 \$890
12 foot	self edge	GRT12WZ2	48 x 144 x 29	100	329	35.14	\$1805 \$902.50
	bullnose edge	GRT12WZ2BN	48 x 144 x 29	150	326	58.70	\$1805 \$902.50
	T-mold edge	GRT12WZ2TM	48 x 144 x 29	100	326	35.14	\$1805 \$902.50
	built-up self edge	GRT12WZ2BU	48 x 144 x 29	100	359	38.32	\$2004 \$1002
14 foot	self edge	GRT14WZ2	48 x 168 x 29	92.5	478	44.44	\$2419 \$1209.50
	bullnose edge	GRT14WZ2BN	48 x 168 x 29	92.5	441	39	\$2419 \$1209.50
	T-mold edge	GRT14WZ2TM	48 x 168 x 29	92.5	441	39	\$2419 \$1209.50
	built-up self edge	GRT14WZ2BU	48 x 168 x 29	92.5	447	42	\$2683 \$1341.50
16 foot	self edge	GRT16WZ2	48 x 192 x 29	92.5	478	42.50	\$2514 \$1257
	bullnose edge	GRT16WZ2BN	48 x 192 x 29	92.5	482	42.50	\$2514 \$1257
	T-mold edge	GRT16WZ2TM	48 x 192 x 29	92.5	482	42.50	\$2514 \$1257
	built-up self edge	GRT16WZ2BU	48 x 192 x 29	92.5	488	47	\$2774 \$1387
18 foot	self edge	GRT18WZ2	48 x 216 x 29	100	523	54.40	\$3270 \$1635
	bullnose edge	GRT18WZ2BN	48 x 216 x 29	100	523	54	\$3270 \$1635
	T-mold edge	GRT18WZ2TM	48 x 216 x 29	100	523	54.40	\$3270 \$1635
	built-up self edge	GRT18WZ2BU	48 x 216 x 29	100	550	59	\$3675 \$1837.50
20 foot	self edge	GRT20WZ2	48 x 240 x 29	100	564	66.20	\$3317 \$1658.50
	bullnose edge	GRT20WZ2BN	48 x 240 x 29	100	564	66.20	\$3317 \$1658.50
	T-mold edge	GRT20WZ2TM	48 x 240 x 29	100	564	66.20	\$3317 \$1658.50
	built-up self edge	GRT20WZ2BU	48 x 240 x 29	100	572	70.60	\$3724 \$1862
22 foot	self edge	GRT22WZ2	48 x 264 x 29	100	604	68.20	\$3694 \$1847
	bullnose edge	GRT22WZ2BN	48 x 264 x 29	100	604	68.20	\$3694 \$1847
	T-mold edge	GRT22WZ2TM	48 x 264 x 29	100	604	68.20	\$3694 \$1847
	built-up self edge	GRT22WZ2BU	48 x 264 x 29	100	612	73.70	\$4127 \$2063.50
24 foot	self edge	GRT24WZ2	48 x 288 x 29	100	646	70.20	\$3790 \$1895
	bullnose edge	GRT24WZ2BN	48 x 288 x 29	100	646	70.20	\$3790 \$1895
	T-mold edge	GRT24WZ2TM	48 x 288 x 29	100	646	70.20	\$3790 \$1895
	built-up self edge	GRT24WZ2BU	48 x 288 x 29	100	655	76.80	\$4216 \$2108

- All Drum Bases require approx. 125 lb. of sand in each base for adequate stability. Sand is not included.
- All tops over 144" are standard in two pieces. Woodgrain laminate finishes will NOT align where the two tops join.
- All tops 168", 192" and 216" are SHIPPED WITH 3 DRUM BASES.
- All tops 240", 264" and 288" are SHIPPED WITH 4 DRUM BASES.

Required Specifications

Finish
Base Finish
Edge Color, if applicable

Optional Specifications

Grommet
HP laminate

Accessories

Power Block

B BOARDROOM TABLES

RACETRACK TOP - ARCH BASE

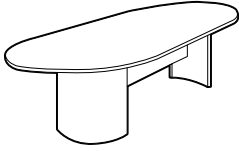

		MODEL#	DIMENSIONS	FREIGHT	CLASS	WT/LBS.	CUBIC FT.	LIST PRICE	HP ADD
			D x W x H						
5 foot	self edge	GRT5A	30 x 60 x 29	85	131	9	\$1047	\$523.50	
	bullnose edge	GRT5ABN	30 x 60 x 29	85	131	9	\$1047	\$523.50	
	T-mold edge	GRT5ATM	30 x 60 x 29	85	131	9	\$1047	\$523.50	
	built-up self edge	GRT5ABU	30 x 60 x 29	85	134	10	\$1188	\$594	
6 foot	self edge	GRT6A	36 x 72 x 29	85	140	11	\$1094	\$547	
	bullnose edge	GRT6ABN	36 x 72 x 29	85	148	11	\$1094	\$547	
	T-mold edge	GRT6ATM	36 x 72 x 29	85	148	11	\$1094	\$547	
	built-up self edge	GRT6ABU	36 x 72 x 29	85	165	12	\$1300	\$650	
7 foot	self edge	GRT7A	44 x 84 x 29	70	203	12.93	\$1332	\$666	
	bullnose edge	GRT7ABN	44 x 84 x 29	70	203	12.93	\$1332	\$666	
	T-mold edge	GRT7ATM	44 x 84 x 29	70	203	12.93	\$1332	\$666	
	built-up self edge	GRT7ABU	44 x 84 x 29	85	206	13.95	\$1509	\$754.50	
8 foot	self edge	GRT8WA	48 x 96 x 29	85	218	14.94	\$1332	\$666	
	bullnose edge	GRT8WABN	48 x 96 x 29	92.5	236	22.40	\$1332	\$666	
	T-mold edge	GRT8WATM	48 x 96 x 29	85	218	14.94	\$1332	\$666	
	built-up self edge	GRT8WABU	48 x 96 x 29	70	244	15.93	\$1509	\$754.50	
10 foot	self edge	GRT10WA	48 x 120 x 29	70	268	16.95	\$1520	\$760	
	bullnose edge	GRT10WABN	48 x 120 x 29	70	268	16.95	\$1520	\$760	
	T-mold edge	GRT10WATM	48 x 120 x 29	70	268	16.95	\$1520	\$760	
	built-up self edge	GRT10WABU	48 x 120 x 29	70	291	18.92	\$1792	\$896	
12 foot	self edge	GRT12WA	48 x 144 x 29	85	309	24.94	\$1757	\$878.50	
	bullnose edge	GRT12WABN	48 x 144 x 29	65	309	11.98	\$1757	\$878.50	
	T-mold edge	GRT12WATM	48 x 144 x 29	100	309	33.29	\$1757	\$878.50	
	built-up self edge	GRT12WABU	48 x 144 x 29	70	342	21.95	\$2051	\$1025.50	
14 foot	self edge	GRT14WA	48 x 168 x 29	70	423	26	\$2704	\$1352	
	bullnose edge	GRT14WABN	48 x 168 x 29	70	423	26	\$2704	\$1352	
	T-mold edge	GRT14WATM	48 x 168 x 29	70	423	26	\$2704	\$1352	
	built-up self edge	GRT14WABU	48 x 168 x 29	70	429	28	\$3013	\$1506.50	
16 foot	self edge	GRT16WA	48 x 192 x 29	70	474	30	\$2844	\$1422	
	bullnose edge	GRT16WABN	48 x 192 x 29	70	474	29.94	\$2844	\$1422	
	T-mold edge	GRT16WATM	48 x 192 x 29	70	474	29.94	\$2844	\$1422	
	built-up self edge	GRT16WABU	48 x 192 x 29	70	480	31.92	\$3180	\$1590	
18 foot	self edge	GRT18WA	48 x 216 x 29	70	525	31.92	\$3506	\$1753	
	bullnose edge	GRT18WABN	48 x 216 x 29	70	525	31.92	\$3506	\$1753	
	T-mold edge	GRT18WATM	48 x 216 x 29	70	525	31.92	\$3506	\$1753	
	built-up self edge	GRT18WABU	48 x 216 x 29	70	532	33.89	\$3917	\$1958.50	
20 foot	self edge	GRT20WA	48 x 240 x 29	70	576	33.89	\$3556	\$1778	
	bullnose edge	GRT20WABN	48 x 240 x 29	70	576	33.89	\$3556	\$1778	
	T-mold edge	GRT20WATM	48 x 240 x 29	70	576	33.89	\$3556	\$1778	
	built-up self edge	GRT20WABU	48 x 240 x 29	70	584	35.93	\$3955	\$1977.50	
22 foot	self edge	GRT22WA	48 x 264 x 29	70	626	36.89	\$3975	\$1987.50	
	bullnose edge	GRT22WABN	48 x 264 x 29	70	626	36.89	\$3975	\$1987.50	
	T-mold edge	GRT22WATM	48 x 264 x 29	70	626	36.89	\$3975	\$1987.50	
	built-up self edge	GRT22WABU	48 x 264 x 29	70	634	37.90	\$4445	\$2222.50	
24 foot	self edge	GRT24WA	48 x 288 x 29	70	678	39.88	\$4071	\$2035.50	
	bullnose edge	GRT24WABN	48 x 288 x 29	70	678	39.88	\$4071	\$2035.50	
	T-mold edge	GRT24WATM	48 x 288 x 29	70	678	39.88	\$4071	\$2035.50	
	built-up self edge	GRT24WABU	48 x 288 x 29	70	687	41.92	\$4536	\$2268	

- All tops over 144" are standard in two pieces. Woodgrain laminate finishes will NOT align where the two tops join.
- All tops 168", 192", 216" and 240" are SHIPPED WITH 2 ARCH BASES AND 1 SLAB BASE.
- All tops 264" and 288" are SHIPPED WITH 2 ARCH BASES AND 2 SLAB BASES.

Required Specifications

Finish
Base Finish
Edge Color, if applicable

Optional Specifications

Grommet
HP laminate

Accessories

Power Block

RACETRACK TOP - 2 LEG BASE



	MODEL#	DIMENSIONS	FREIGHT	CLASS	WT/LBS.	CUBIC FT.	LIST PRICE	HP ADD
		D x W x H						
5 foot	self edge	GRT5	30 x 60 x 29	125	88	13	\$924	\$462
	bullnose edge	GRT5BN	30 x 60 x 29	125	88	13	\$924	\$462
	T-mold edge	GRT5TM	30 x 60 x 29	125	88	13	\$924	\$462
	built-up self edge	GRT5BU	30 x 60 x 29	125	91	14	\$1032	\$516
6 foot	self edge	GRT6	36 x 72 x 29	125	111	15	\$1029	\$514.50
	bullnose edge	GRT6BN	36 x 72 x 29	125	119	15	\$1029	\$514.50
	T-mold edge	GRT6TM	36 x 72 x 29	125	119	15	\$1029	\$514.50
	built-up self edge	GRT6BU	36 x 72 x 29	100	136	16	\$1144	\$572
7 foot	self edge	GRT7	44 x 84 x 29	100	155	17	\$1189	\$594.50
	bullnose edge	GRT7BN	44 x 84 x 29	100	155	17	\$1189	\$594.50
	T-mold edge	GRT7TM	44 x 84 x 29	100	155	17	\$1189	\$594.50
	built-up self edge	GRT7BU	44 x 84 x 29	100	158	19	\$1333	\$666.50
8 foot	self edge	GRT8W	48 x 96 x 29	100	178	19	\$1189	\$594.50
	bullnose edge	GRT8WBN	48 x 96 x 29	100	180	19	\$1189	\$594.50
	T-mold edge	GRT8WTM	48 x 96 x 29	100	178	19	\$1189	\$594.50
	built-up self edge	GRT8WBU	48 x 96 x 29	100	204	21	\$1333	\$666.50
10 foot	self edge	GRT10W	48 x 120 x 29	300	39	21	\$1653	\$826.50
	bullnose edge	GRT10WBN	48 x 120 x 29	92.5	231	21	\$1653	\$826.50
	T-mold edge	GRT10WTM	48 x 120 x 29	92.5	221	21	\$1653	\$826.50
	built-up self edge	GRT10WBU	48 x 120 x 29	92.5	254	23	\$1849	\$924.50
12 foot	self edge	GRT12W	48 x 144 x 29	92.5	271	23	\$1859	\$929.50
	bullnose edge	GRT12WBN	48 x 144 x 29	92.5	268	23	\$1859	\$929.50
	T-mold edge	GRT12WTM	48 x 144 x 29	92.5	268	23	\$1859	\$929.50
	built-up self edge	GRT12WBU	48 x 144 x 29	92.5	301	25.90	\$2073	\$1036.50
14 foot	self edge	GRT14W	48 x 168 x 29	100	326	34	\$2134	\$1067
	bullnose edge	GRT14WBN	48 x 168 x 29	100	326	34	\$2134	\$1067
	T-mold edge	GRT14WTM	48 x 168 x 29	100	326	34	\$2134	\$1067
	built-up self edge	GRT14WBU	48 x 168 x 29	100	332	38	\$2358	\$1179
16 foot	self edge	GRT16W	48 x 192 x 29	100	367	38	\$2229	\$1114.50
	bullnose edge	GRT16WBN	48 x 192 x 29	100	367	38	\$2229	\$1114.50
	T-mold edge	GRT16WTM	48 x 192 x 29	100	367	38	\$2229	\$1114.50
	built-up self edge	GRT16WBU	48 x 192 x 29	100	368	40	\$2414	\$1207
18 foot	self edge	GRT18W	48 x 216 x 29	92.5	408	40	\$2655	\$1327.50
	bullnose edge	GRT18WBN	48 x 216 x 29	92.5	408	40	\$2655	\$1327.50
	T-mold edge	GRT18WTM	48 x 216 x 29	92.5	408	40	\$2655	\$1327.50
	built-up self edge	GRT18WBU	48 x 216 x 29	100	416	42	\$2962	\$1481
20 foot	self edge	GRT20W	48 x 240 x 29	92.5	449	42	\$2750	\$1375
	bullnose edge	GRT20WBN	48 x 240 x 29	92.5	449	42	\$2750	\$1375
	T-mold edge	GRT20WTM	48 x 240 x 29	92.5	449	42	\$2750	\$1375
	built-up self edge	GRT20WBU	48 x 240 x 29	92.5	457	44	\$3052	\$1526
22 foot	self edge	GRT22W	48 x 264 x 29	92.5	489	44	\$3033	\$1516.50
	bullnose edge	GRT22WBN	48 x 264 x 29	92.5	489	44	\$3033	\$1516.50
	T-mold edge	GRT22WTM	48 x 264 x 29	92.5	489	44	\$3033	\$1516.50
	built-up self edge	GRT22WBU	48 x 264 x 29	92.5	497	46	\$3414	\$1707
24 foot	self edge	GRT24W	48 x 288 x 29	92.5	531	46	\$3126	\$1563
	bullnose edge	GRT24WBN	48 x 288 x 29	92.5	531	46	\$3126	\$1563
	T-mold edge	GRT24WTM	48 x 288 x 29	92.5	531	46	\$3126	\$1563
	built-up self edge	GRT24WBU	48 x 288 x 29	92.5	540	48	\$3494	\$1747

- All tops over 144" are standard in two pieces. Woodgrain laminate finishes will NOT align where the two tops join.
- All tops 120", 144", and 168" are SHIPPED WITH 3 LEG BASES.
- All tops 192" are SHIPPED WITH 4 LEG BASES.
- All tops 216", 240", 264" and 288" are SHIPPED WITH 6 LEG BASES.

Required Specifications

Finish
Base Finish
Edge Color, if applicable

Optional Specifications

Grommet
HP laminate

Accessories

Power Block

B BOARDROOM TABLES

RACETRACK TOP - TUBULAR BASE



		MODEL#	DIMENSIONS	FREIGHT CLASS	WT/LBS.	CUBIC FT.	LIST PRICE	HP ADD
			D x W x H					
5 foot	self edge	GRT5R	30 x 60 x 29	150	94	21	\$953	\$476.50
	bullnose edge	GRT5RBN	30 x 60 x 29	150	94	21	\$953	\$476.50
	T-mold edge	GRT5RTM	30 x 60 x 29	150	94	21	\$953	\$476.50
	built-up self edge	GRT5RBU	30 x 60 x 29	150	97	23	\$1064	\$532
6 foot	self edge	GRT6R	36 x 72 x 29	150	107	23	\$1058	\$529
	bullnose edge	GRT6RBN	36 x 72 x 29	150	107	23	\$1058	\$529
	T-mold edge	GRT6RTM	36 x 72 x 29	150	107	23	\$1058	\$529
	built-up self edge	GRT6RBU	36 x 72 x 29	150	117	25	\$1178	\$589
7 foot	self edge	GRT7R	44 x 84 x 29	125	161	25	\$1219	\$609.50
	bullnose edge	GRT7RBN	44 x 84 x 29	125	161	25	\$1219	\$609.50
	T-mold edge	GRT7RTM	44 x 84 x 29	125	161	25	\$1219	\$609.50
	built-up self edge	GRT7RBU	44 x 84 x 29	125	164	27	\$1364	\$682
8 foot	self edge	GRT8WR	48 x 96 x 29	125	175	27	\$1219	\$609.50
	bullnose edge	GRT8WRBN	48 x 96 x 29	125	177	27	\$1219	\$609.50
	T-mold edge	GRT8WRTM	48 x 96 x 29	125	175	27	\$1219	\$609.50
	built-up self edge	GRT8WRBU	48 x 96 x 29	125	176	29	\$1364	\$682
10 foot	self edge	GRT10WR	48 x 120 x 29	125	221	29	\$1670	\$835
	bullnose edge	GRT10WRBN	48 x 120 x 29	125	221	29	\$1670	\$835
	T-mold edge	GRT10WRTM	48 x 120 x 29	125	221	29	\$1670	\$835
	built-up self edge	GRT10WRBU	48 x 120 x 29	125	239	32	\$1873	\$936.50
12 foot	self edge	GRT12WR	48 x 144 x 29	100	270	31	\$1881	\$940.50
	bullnose edge	GRT12WRBN	48 x 144 x 29	100	270	31	\$1881	\$940.50
	T-mold edge	GRT12WRTM	48 x 144 x 29	100	270	30.90	\$1881	\$940.50
	built-up self edge	GRT12WRBU	48 x 144 x 29	100	301	34	\$2100	\$1050
14 foot	self edge	GRT14WR	48 x 168 x 29	125	330	50	\$2162	\$1081
	bullnose edge	GRT14WRBN	48 x 168 x 29	125	330	50	\$2162	\$1081
	T-mold edge	GRT14WRTM	48 x 168 x 29	125	330	50	\$2162	\$1081
	built-up self edge	GRT14WRBU	48 x 168 x 29	125	326	54	\$2387	\$1193.50
16 foot	self edge	GRT16WR	48 x 192 x 29	125	371	54	\$2256	\$1128
	bullnose edge	GRT16WRBN	48 x 192 x 29	125	371	54	\$2256	\$1128
	T-mold edge	GRT16WRTM	48 x 192 x 29	125	371	54	\$2256	\$1128
	built-up self edge	GRT16WRBU	48 x 192 x 29	125	377	58	\$2478	\$1239
18 foot	self edge	GRT18WR	48 x 216 x 29	125	412	56	\$2673	\$1336.50
	bullnose edge	GRT18WRBN	48 x 216 x 29	125	412	56	\$2673	\$1336.50
	T-mold edge	GRT18WRTM	48 x 216 x 29	125	412	56	\$2673	\$1336.50
	built-up self edge	GRT18WRBU	48 x 216 x 29	125	419	60	\$2986	\$1493
20 foot	self edge	GRT20WR	48 x 240 x 29	125	453	58	\$2768	\$1384
	bullnose edge	GRT20WRBN	48 x 240 x 29	125	453	58	\$2768	\$1384
	T-mold edge	GRT20WRTM	48 x 240 x 29	125	453	58	\$2768	\$1384
	built-up self edge	GRT20WRBU	48 x 240 x 29	125	461	62	\$3086	\$1543
22 foot	self edge	GRT22WR	48 x 264 x 29	100	493	60	\$3080	\$1540
	bullnose edge	GRT22WRBN	48 x 264 x 29	100	493	60	\$3080	\$1540
	T-mold edge	GRT22WRTM	48 x 264 x 29	100	493	60	\$3080	\$1540
	built-up self edge	GRT22WRBU	48 x 264 x 29	125	501	64	\$3440	\$1720
24 foot	self edge	GRT24WR	48 x 288 x 29	100	535	62	\$3177	\$1588.50
	bullnose edge	GRT24WRBN	48 x 288 x 29	100	535	62	\$3177	\$1588.50
	T-mold edge	GRT24WRTM	48 x 288 x 29	100	535	62	\$3177	\$1588.50
	built-up self edge	GRT24WRBU	48 x 288 x 29	100	544	66	\$3530	\$1765

- All tops over 144" are standard in two pieces. Woodgrain laminate finishes will NOT align where the two tops join.
- All tops 120", 144", and 168" are SHIPPED WITH 3 TUBULAR BASES.
- All tops 192" are SHIPPED WITH 4 TUBULAR BASES.
- All tops 216", 240", 264" and 288" are SHIPPED WITH 6 TUBULAR BASES.

Required Specifications

Finish
Base Finish
Edge Color, if applicable

Optional Specifications

Grommet
HP laminate

Accessories

Power Block

BUNGEE™ TABLES



Bungee is a series of freestanding tables and accessories designed for classrooms, training rooms, boardrooms and any other multi-functional space that may require frequent configurations. Tables are sold complete with legs and Bungee cords so they may quickly and easily be connected together without searching for tools or worrying about loose parts.

Bungee tables feature rounded corners with a unique “bubble molding” that is engineered to compress under the tension of the Bungee cords. The compressed molding creates a seal that serves to locate and align interconnected tables while also providing a soft and forgiving edge.

Choose from a variety of top shapes and laminate finishes to create your individual style. In addition, most tables offer a choice of tapered legs or spider legs in a Silver or Black finish with adjustable levellers or optional casters. Optional modesty panels, grommets, wire management and power blocks further enhance your workspace.

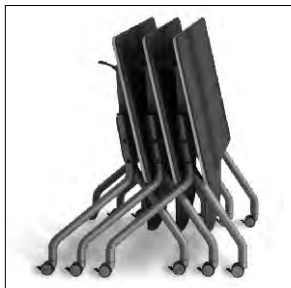

Flip-Top tables can be nested and easily stored by activating the single hand release mechanism from the left or right side.

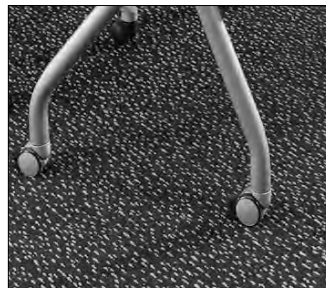

Optional locking casters are available in Silver or Black finish (standard on Flip-Top models).

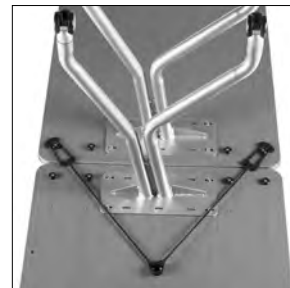

Bungee cords are utilized to quickly and easily reconfigure tables



Features and Benefits

- Bungee tables are complete with Top, Legs and Bungee cords
- Bungee cords provide a fast and easy method of reconfiguring tables without requiring a tool
- Tops are 1” thick and are offered in a variety of shapes and sizes
- Legs are offered in Tapered or Spider design in a Silver or Black finish. Levelers are standard
- Laminate modesty panels and filler modesty inserts help conceal wires and enhance visual appeal
- Wire management tracks neatly contain wires, using two separate channels for data and voice wires
- Optional grommets or power blocks offer technological flexibility
- Models with handles feature a bow handle in Silver or Black Nickel finish
- Metal feet are height adjustable and offered in Silver or Black Nickel finish
- Boardrooms were never easier to specify - table “sets” and accessories such as AV Cabinets and Credenza Buffets are specified with one model number

B BUNGEE™ TABLES - NOTES

GENERAL INFORMATION

- Bungee is a series of freestanding tables and accessories designed for classrooms, training rooms, boardrooms and any other multifunctional space that requires frequent reconfigurations.
- Bungee tables come complete with a work top, a set of legs and built-in Bungee cord connectors
- Bungee cords allow the movement and reconfiguration of tables without a risk of damage or losing loose parts
- High pressure tops are available in all Bungee laminate finishes at an extended lead time - please see model # for pricing.
- Unique “bubble molding” edging is specially engineered to create a secure seal to align interconnected tables.
- Bungee products have been tested and comply with all mechanical tests
- For environmental certifications, please visit globalfurnituregroup.com

CONSTRUCTION

- Tops are 1” thick. Modesty panels are 1/4” thick.
- All components are made of 45 lb. commercial density particle board, covered on both sides with high performance, thermally fused laminate.
- Tops 54” and over feature a built-in support bar.
- Products specified with the high pressure laminate option are finished on the underside of the surface with a kraft paper backing.

BUNGEE CORDS

- Bungee cords are patented elastic devices designed to provide a rapid, no-tool method of attaching tables of the same depth.
- The elastic nature of cords allows two connected tables to be moved around without risk of damage to the table top or connecting hardware.
- Bungee cords are included with all freestanding tables and carry a lifetime warranty.

EDGE DETAIL

- Bungee comes with a choice of four edge styles (check model for edge availability):



A3 - square corner, standard edge



AR - square corner, bicut edge



AS - square corner, Silver



AB - square corner, Black



BS - rounded corner, Silver



BB - rounded corner, Black

- **BB/BS** - Bungee Bubble Edge: unique “bubble” molding is engineered to compress under the tension of the Bungee cords, creating a seal that serves to locate and align interconnected tables.
- **AB/AS** - Split color PVC edge: edge matches split color aesthetic of the bubble edge, but allows for 90 degree corners and a cleaner look.
- **A3** - Global’s preferred edge. Coordinates well with Adaptabilities and Zira 1” tops.
- **AR** - Bicut edge. Coordinates well with Zira 1” tops.
- **NOTE:** Trapezoid tables can only be specified with Bubble Edge (Rounded Corners).
- **NOTE:** Boardroom Table sets allow for all edge types but **ONLY** with rounded corners (when AS/AB/A3/AR are selected, the table will be produced with rounded corners).

LEGS

- Tables feature two styles of legs - Tapered leg or Spider leg. Legs on fixed tables offer glides or casters. Adjusts 3mm-10mm in height.
- For legs and glides in Silver, specify **(SI)**.
- For legs and glides in Black, specify **(BK)**.
- For legs and casters in Silver, specify as Silver **(CS)**.
- For legs and casters in Black, specify **(CK)**.



Tapered Leg



Spider Leg

HANDLES

- Metal handles are standard on all drawers and doors. Handles are offered in two finishes: Silver **(HS)** or Black Nickel **(HT)**, please specify
- Handle finish will match leg finish.



bow handle, Silver finish **(HS)**



bow handle, Black Nickel finish **(HT)**

FEET

- Metal feet are standard on all cabinets. Feet adjust 3/4” in height.
- Feet are available in Silver Finish **(SI)** or Black Finish **(BK)**.



SI - Silver Finish



BK - Black Nickel Finish

MODESTY PANELS

- Panels are 9.5” high, recessed 3/4” from the back and inset 7” from the sides.
- Available in all Bungee laminate finishes.
- Edge available in Silver finish **(SI)** or Black finish **(BK)**. Please specify.

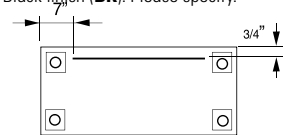
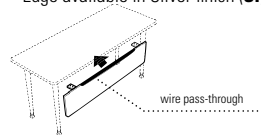

FILLER MODESTY PANELS

- Used to fill the space between two modesty panels when two tables are linked together. Helps conceal wires and enhance visual appeal.
- Available in Silver Finish **(SI)** or Black Finish **(BK)**. Please specify.

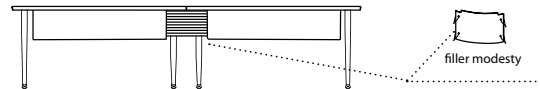

WIRE MANAGEMENT

- Wire management tracks are mounted to the underside of the worksurface. Available in 5” and 22” track lengths.
- 5” track includes one wire clamp; 22” track includes two wire clamps.
- Data and voice wires can be routed separately using two separate channels on each clamp.
- Available in Black only.

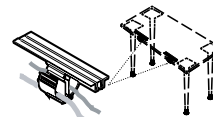

5” Wire Management Track

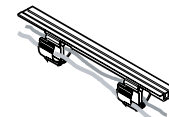

22” Wire Management Track

1. SPECIFY MODEL NUMBER

2. SPECIFY FINISH

Laminate Finishes:

ACJ	Absolute Acajou	HGT	Hayden Grey
ASN	Asian Night	QTM	Quartered Mahogany
AWC	Avant Cherry	SOG	Storm Grey
AWH	Avant Honey	TFW	Tiger Fruitwood
BLK	Black	TWL	Tiger Walnut
BRC	Brushed Cobalt	WHE	Walnut Heights
CMB	Clear Maple	WHC	White Chocolate
DES	Dark Espresso	WCR	Winter Cherry
DWT	Designer White	WGY	Willow Grey

Edge:

BB	Bungee bubble edge with Black trim
BS	Bungee bubble edge with Silver trim
AB	Split color edge with Black trim
AS	Split color edge with Silver trim
A3	Matching edge
AR	Matching bicut edge

Legs:

SI	Silver
BK	Black Nickel

Casters:

CS	Silver
CK	Black Nickel

Handles:

HS	Silver
HT	Black Nickel

Modesty Panel Edge:

SI	Silver
BK	Black Nickel

Feet:

SI	Silver	BK	Black Nickel
----	--------	----	--------------

3. SPECIFY OPTIONS

GROMMETS

- Optional Grommets available in standard worksurface locations (left, center or right) for **Rectangular Tops 48" and up**. Order as: **AG1, AG2 or AG3 - Add \$69**
- Additional grommets are available in **center position only** for **Rectangular Tops (36", 42" and 48") and Trapezoid Tables**. Order as **AG2 - Add \$69**.
- Grommet hole dimensions are 3 1/4" wide x 1 7/8" deep.
- Grommets may be placed at non-standard locations. Order as: **AGS - Add \$69**. A drawing must be supplied with vertical and horizontal dimensions to the center of the cut-out (as in drawing above). Please refer to CUSTOM GROMMET LOCATION FORM in the back reference section.

Grommet hole dimensions

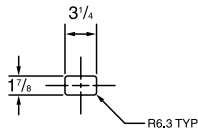

Grommet

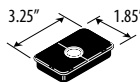

Rectangular Tops

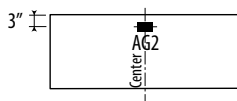

For **36"** and **42"** wide units

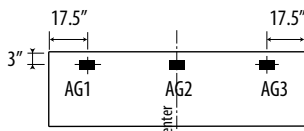

For **48"**, **60"** and **72"** wide units



Trapezoid Tables

Grommet Location - **AG2...Add \$69**

POWER BLOCK

- A Power Block is a rectangular worksurface power/data module with one electrical duplex receptacle and two data (RJ45) receptacles. 9' black cord included. Power Block dimensions are 3 1/2" deep x 6 1/2" wide x 2 3/4" high.
- A Power Block (model **PMSPDM**) may be ordered for **Rectangular Tables 60" and up** in place of standard grommets. Order as **E1, E2 or E3 - Add \$69**.
- Additional Power Blocks are available in **center position only** for **Rectangular Tops (36", 42" and 48") and Trapezoid Tables**. Order as **E2 - Add \$69**.

- To purchase a Power Block, you must specify both the Power Block cut-out location and the Power Block model #. Order Power Block as **PMSPDM, Add \$261**.
- Power Blocks are available in standard worksurface locations (left, center or right). Order as **E1, E2 or E3. Add \$69**.
- See above for examples of placement.



Power Block **PMSPDM Add \$261**

Rectangular Tops

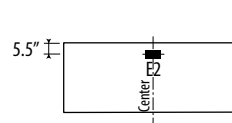

For **36"**, **42"** and **48"** wide units

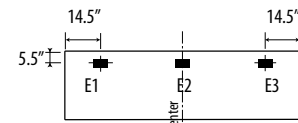

For **60"** and **72"** wide units

VILLA CUTOUTS

- Optional Villa cutout available in standard worksurface locations (left, center or right) for **Rectangular Tables 60" and up**. Order as: **V1, V2 or V3 - Add \$69 for each cutout**.
- Additional power block cutouts are available in **center position only** for **Rectangular Tops (36", 42" and 48") and Trapezoid Tables**. Order as **V2 - Add \$69**.
- Villa cutouts may be placed at non-standard locations. Please contact customer care.
- To purchase a Villa Power Block, you must specify both the Villa Power Block cutout location and the Power Block model #. Please see page 545 for Villa models.

Rectangular Tops

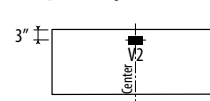

For **36"**, **42"** and **48"** wide units

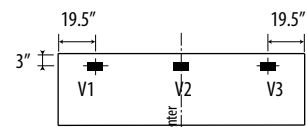

For **60"** and **72"** wide units

B BUNGEE™ TABLES

CONNECTING CONDITIONS

- Bungee cords allow for fast and easy reconfiguring of tables whenever needed. Due to the elastic nature of the Bungee cord, two tables connected with Bungee cords can be moved around without risk of damage to the table top or the connecting hardware.
- Connecting tables is simple and intuitive. Tools are not required and there are no loose parts that may be misplaced.
- Bungee cords connect tables of the same depth in all directions.
- Rectangular Tables 48" and longer connect in both Straight and "L" configurations. Rectangular Tables 36" and 42" connect in Straight configurations only.

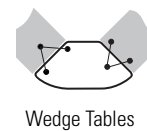
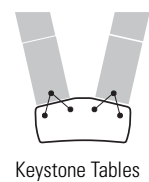
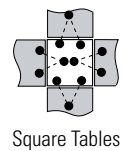
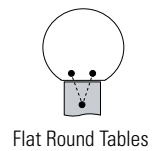
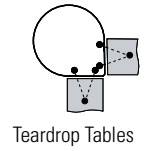
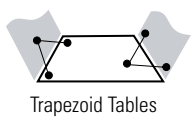
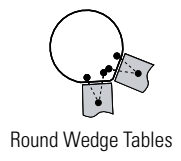
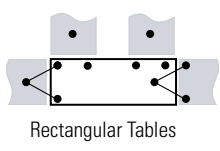
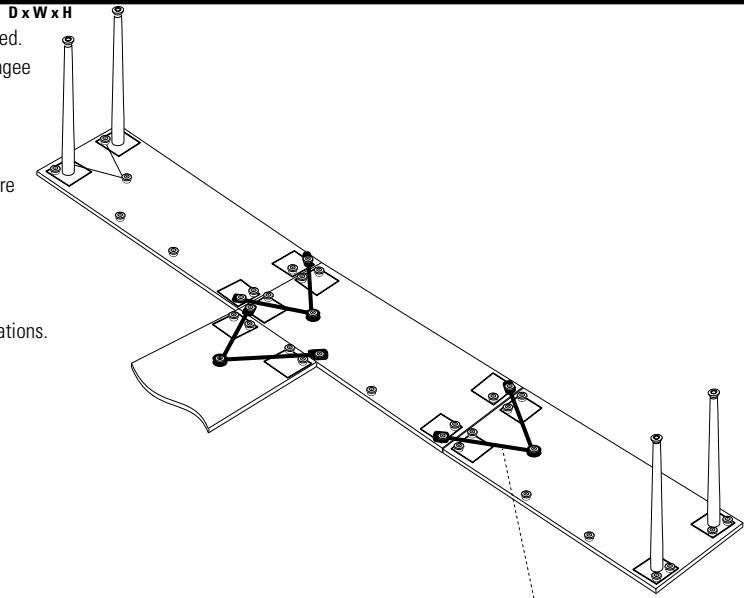

SAMPLE TABLE CONFIGURATIONS

• The following table configurations can be created using Bungee Boardroom Table Sets only.

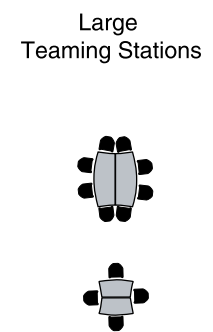
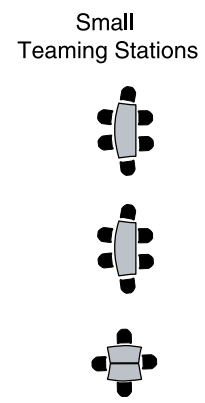
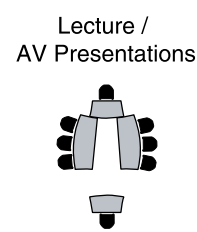
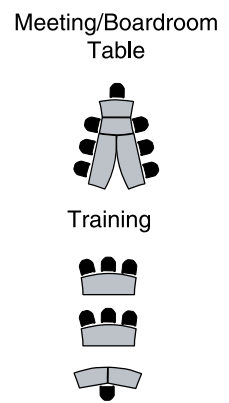
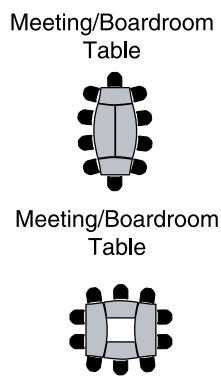

FLIP TOP TABLE NESTING DIAGRAM

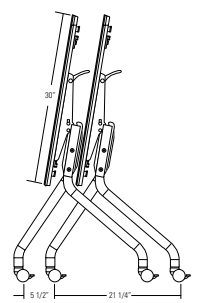
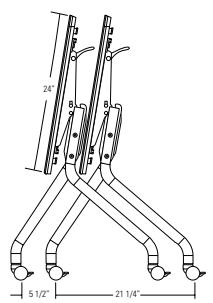
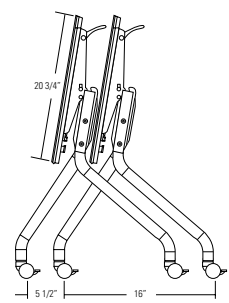

RECTANGULAR TABLES

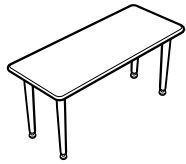
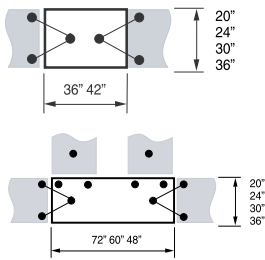

Rectangular Table - Tapered Legs

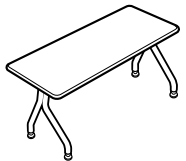
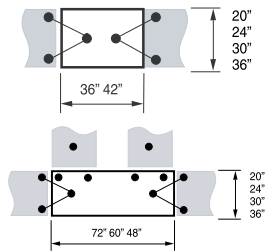

Rectangular Table - Spider Legs

MODEL#	DIMENSIONS	FREIGHT CLASS	WT/LBS.	CUBIC FT.	LIST PRICE	HP ADD
D x W x H						
B2036REF	20 x 36 x 29	92.5	59	5.26	\$656	\$132
B2042REF	20 x 42 x 29	92.5	62	5.76	\$680	\$176
B2048REF	20 x 48 x 29	92.5	67	6	\$706	\$176
B2060REF	20 x 60 x 29	92.5	74	7	\$800	\$243
B2072REF	20 x 72 x 29	92.5	81	7.26	\$876	\$274
B2436REF	24 x 36 x 29	92.5	65	5.76	\$694	\$132
B2442REF	24 x 42 x 29	92.5	69	6	\$718	\$176
B2448REF	24 x 48 x 29	92.5	72	6.50	\$742	\$176
B2460REF	24 x 60 x 29	92.5	82	7.26	\$857	\$264
B2472REF	24 x 72 x 29	92.5	91	8	\$926	\$411
B3036REF	30 x 36 x 29	100	70	7.26	\$686	\$248
B3042REF	30 x 42 x 29	92.5	78	7.50	\$718	\$274
B3048REF	30 x 48 x 29	92.5	81	7.50	\$738	\$264
B3060REF	30 x 60 x 29	92.5	92	8.26	\$857	\$330
B3072REF	30 x 72 x 29	92.5	102	9	\$939	\$411
B3642REF	36 x 42 x 29	150	83	15	\$787	\$264
B3648REF	36 x 48 x 29	92.5	91	8	\$863	\$250
B3660REF	36 x 60 x 29	92.5	103	9	\$939	\$311
B3672REF	36 x 72 x 29	92.5	116	10	\$1050	\$395

Freestanding table includes four tapered legs with levellers and Bungee cords. Each table can be "Bungee-tied" to other tables of the same depth. Shipped RTA (ready to assemble). Modesty panels available, see page 611.

- **Tables 48" and longer connect in both Straight and "L" configurations**
- **Tables 36" and 42" connect in Straight configurations only.**
- Available with optional locking casters, specify option "CS" or "CK".

B2036RES	20 x 36 x 29	100	57	6.76	\$738	\$132
B2042RES	20 x 42 x 29	100	60	7.26	\$762	\$176
B2048RES	20 x 48 x 29	100	65	7.50	\$787	\$176
B2060RES	20 x 60 x 29	100	72	8.50	\$888	\$243
B2072RES	20 x 72 x 29	100	79	8.76	\$969	\$274
B2436RES	24 x 36 x 29	100	62	7.26	\$781	\$132
B2442RES	24 x 42 x 29	150	64	15	\$800	\$176
B2448RES	24 x 48 x 29	125	71	10	\$831	\$176
B2460RES	24 x 60 x 29	125	80	10.76	\$939	\$264
B2472RES	24 x 72 x 29	125	89	11.26	\$1018	\$411
B3036RES	30 x 36 x 29	125	72	10.26	\$800	\$248
B3042RES	30 x 42 x 29	125	80	10.50	\$824	\$274
B3048RES	30 x 48 x 29	125	83	10.50	\$851	\$303
B3060RES	30 x 60 x 29	100	94	11.26	\$969	\$303
B3072RES	30 x 72 x 29	100	104	12	\$1039	\$412

Freestanding table includes two spider legs with levellers and Bungee cords. Each table can be "Bungee-tied" to other tables of the same depth. Shipped RTA (ready to assemble). Modesty panels available, see page 611.

- **Tables 48" and longer connect in both Straight and "L" configurations**
- **Tables 36" and 42" connect in Straight configurations only.**
- Available with optional locking casters, specify option "CS" or "CK".

Required Specifications

Top finish
Edge
Leg finish

Optional Specifications

Casters
Grommet
Modesty Panel
High Pressure Laminate

Accessories

Power Block

B BUNGEE™ TABLES

TRAPEZOID TABLES

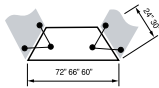

Trapezoid Table - Tapered Legs

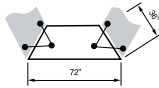
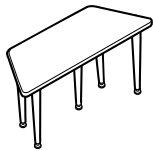

Trapezoid Table - Tapered Legs

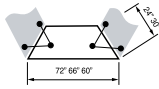
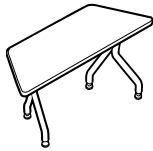

Trapezoid Table - Spider Legs

MODEL#	DIMENSIONS	FREIGHT CLASS	WT/LBS.	CUBIC FT.	LIST PRICE	HP ADD
--------	------------	---------------	---------	-----------	------------	--------

D x W x H

B2460TRF	24 x 60 x 29	100	71	7.50	\$787	\$264
B2466TRF	24 x 66 x 29	100	74	8	\$807	\$411
B2472TRF	24 x 72 x 29	100	78	8.26	\$868	\$411
B3060TRF	30 x 60 x 29	100	78	8.50	\$842	\$303
B3066TRF	30 x 66 x 29	100	81	9.50	\$876	\$411
B3072TRF	30 x 72 x 29	100	85	9.50	\$932	\$411

Freestanding table includes four tapered legs with levelers and Bungee cords. Each table can be "Bungee-tied" to other tables of the same depth. Shipped RTA (ready to assemble). Modesty panels available, see page 611.

- Available with bubble edge (BB or BS) only.

B3672TRF	36 x 72 x 29	100	91	10.50	\$1076	\$395
----------	--------------	-----	----	-------	---------------	--------------

Freestanding table includes five tapered legs with levelers and Bungee cords. Each table can be "Bungee-tied" to other tables of the same depth. Shipped RTA (ready to assemble). Modesty panels available, see page 611.

- Available with bubble edge (BB or BS) only.
- Available with optional locking casters, specify option "CS" or "CK".

B2060TRS	20 x 60 x 29	125	67	8.76	\$851	\$243
B2066TRS	20 x 66 x 29	125	68	9	\$876	\$274
B2072TRS	20 x 72 x 29	125	74	9.26	\$911	\$274

B2460TRS	24 x 60 x 29	125	69	9.26	\$876	\$264
B2466TRS	24 x 66 x 29	125	72	9.76	\$911	\$411
B2472TRS	24 x 72 x 29	125	76	10	\$949	\$411

B3060TRS	30 x 60 x 29	125	79	11.50	\$943	\$303
B3066TRS	30 x 66 x 29	125	83	12.50	\$977	\$411
B3072TRS	30 x 72 x 29	125	87	12.50	\$1032	\$411

Freestanding table includes two spider legs with levelers and Bungee cords. Each table can be "Bungee-tied" to other tables of the same depth. Shipped RTA (ready to assemble). Modesty panels available, see page 611.

- Available with bubble edge (BB or BS) only.
- Available with optional locking casters, specify option "CS" or "CK".

KEYSTONE TABLES

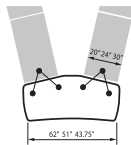
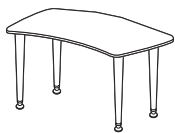

Keystone Table - Tapered Legs

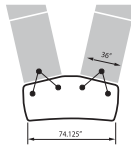
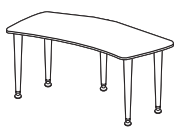

Keystone Table - Tapered Legs

B30KSF	30 x 62 x 29	150	69	15.20	\$835	\$330
B24KSF	24 x 51 x 29	150	60	13	\$773	\$221
B20KSF	20 x 43.75 x 29	150	58	13	\$763	\$176

Freestanding table includes four tapered legs with levelers and Bungee cords. Each table can be "Bungee-tied" to other tables of 24" and 30" depth. Shipped RTA (ready to assemble). Modesty panels or Filler Modestys are NOT available.

B36KSF	36 x 74.13 x 29	150	84	16.80	\$1033	\$466
--------	-----------------	-----	----	-------	---------------	--------------

Freestanding table includes five tapered legs with levelers and Bungee cords. Each table can be "Bungee-tied" to other tables of 24" and 30" depth. Shipped RTA (ready to assemble). Modesty panels or Filler Modestys are NOT available.

Required Specifications

Top finish
Edge
Leg finish

Optional Specifications

Grommet
Casters (Trapezoid Tables only)
Modesty panel (Trapezoid Tables only)
HP laminate

Accessories

Power block

KEYSTONE TABLES

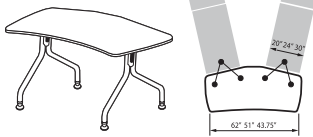

Keystone Table - Spider Legs

MODEL#	DIMENSIONS	FREIGHT CLASS	WT/LBS.	CUBIC FT.	LIST PRICE	HP ADD
	D x W x H					
B30KSS	30 x 62 x 29	150	77	15.20	\$976	\$329
B24KSS	24 x 51 x 29	150	66	13	\$908	\$204
B20KSS	20 x 43.75 x 29	150	64	13	\$891	\$176

Freestanding table includes two spider legs with levelers and Bungee cords. Each table can be "Bungee-tied" to other tables of 24" and 30" depth. Shipped RTA (ready to assemble). Modesty panels or Filler Modestys are NOT available.

WEDGE TABLES

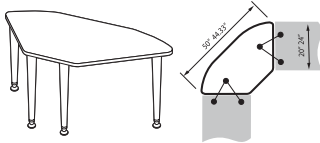

Wedge Table - Tapered Legs

B24WEF	24 x 63 x 29	150	54	13.20	\$808	\$220
B20WEF	20 x 57 x 29	150	46	10.20	\$740	\$176

Freestanding table includes four tapered legs with levelers and Bungee cords. Each table can be "Bungee-tied" to other tables of the same depth. Shipped RTA (ready to assemble). Modesty panels are NOT available.

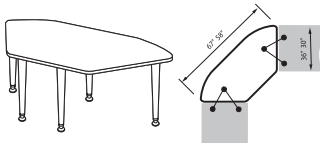

Wedge Table - Tapered Legs

B36WEF	36 x 80 x 29	150	84	18.80	\$1101	\$395
B30WEF	30 x 70 x 29	150	70	14.40	\$976	\$274

Freestanding table includes five tapered legs with levelers and Bungee cords. Each table can be "Bungee-tied" to other tables of the same depth. Shipped RTA (ready to assemble). Modesty panels are NOT available.

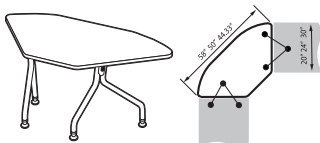

Wedge Table - Spider Legs

B30WES	30 x 70 x 29	150	73	14.40	\$966	\$276
B24WES	24 x 63 x 29	150	62	13.20	\$903	\$220
B20WES	20 x 57 x 29	150	52	10.20	\$835	\$176

Freestanding table includes two spider legs with levelers and Bungee cords. Each table can be "Bungee-tied" to other tables of the same depth. Shipped RTA (ready to assemble). Modesty panels are NOT available.

HALF MOON TABLES

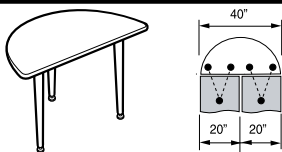

Half Moon Table - Tapered Legs

B2040HMF	20 x 40 x 29	100	49	6	\$519	\$176
----------	--------------	-----	----	---	--------------	--------------

Freestanding table includes three tapered legs with levelers and Bungee cords. Each table can be "Bungee-tied" to other tables of the same depth. Shipped RTA (ready to assemble). Modesty panels or Filler Modestys are NOT available.

- Available with optional locking casters, specify option "CS" or "CK".

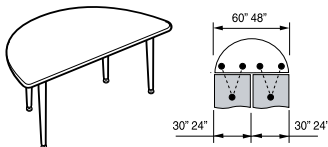

Half Moon Table - Tapered Legs

B2448HMF	24 x 48 x 29	100	69	7.76	\$675	\$176
B3060HMF	30 x 60 x 29	100	81	8.50	\$718	\$303

Freestanding table includes four tapered legs with levelers and Bungee cords. Each table can be "Bungee-tied" to other tables of the same depth. Shipped RTA (ready to assemble). Modesty panels or Filler Modestys are NOT available.

- Available with optional locking casters, specify option "CS" or "CK".

Required Specifications

Top finish
Edge
Leg finish

Optional Specifications

Casters (Half Moon Tables only)
High Pressure Laminate

Accessories

Power Block (position 2 only)

B BUNGEE™ TABLES

HALF MOON TABLES

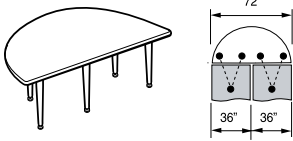

Half Moon Table - Tapered Legs

MODEL#	DIMENSIONS D x W x H	FREIGHT CLASS	WT./LBS.	CUBIC FT.	LIST PRICE	HP ADD
B3672HMF	36 x 72 x 29	100	110	11.50	\$1012	\$395

Freestanding table includes five tapered legs with levellers and Bungee cords. Each table can be "Bungee-tied" to other tables of the same depth. Shipped RTA (ready to assemble). Modesty panels or Filler Modestys are NOT available.

- Available with optional locking casters, specify option "CS" or "CK".

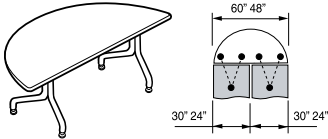

Half Moon Table - Spider Legs

B2448HMS	24 x 48 x 29	125	67	9.26	\$768	\$176
B3060HMS	30 x 60 x 29	125	83	11.50	\$824	\$303

Freestanding table includes two spider legs with levellers and Bungee cords. Each table can be "Bungee-tied" to other tables of the same depth. Shipped RTA (ready to assemble). Modesty panels or Filler Modestys are NOT available.

- Available with optional locking casters, specify option "CS" or "CK".

SQUARE TABLES

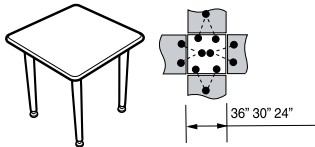

Square Table - Tapered Legs

B2424SQF	24 x 24 x 29	92.5	55	4.60	\$643	\$112
B3030SQF	30 x 30 x 29	100	65	7.50	\$656	\$166
B3636SQF	36 x 36 x 29	100	78	8	\$750	\$199

Freestanding table includes four tapered legs with levellers and Bungee cords. Each table can be "Bungee-tied" to other tables of the same depth. Shipped RTA (ready to assemble). Modesty panels available, see page 611.

- Available with optional locking casters, specify option "CS" or "CK".

ROUND WEDGE TABLES

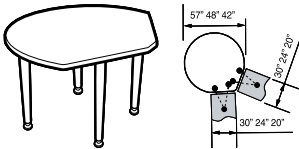

Round Wedge 120° Table

B2042RWF	20 x 42 x 29	100	76	8.26	\$718	\$385
B2448RWF	24 x 48 x 29	125	85	10.76	\$738	\$385
B3057RWF	30 x 57 x 29	100	102	12	\$876	\$548

Freestanding table includes four tapered legs with levellers and Bungee cords. Each table can be "Bungee-tied" to other tables of the same depth. Shipped RTA (ready to assemble). Modesty panels or Filler Modestys are NOT available.

- Available with bubble edge (BB or BS) only.
- Available with optional locking casters, specify option "CS" or "CK".

TEARDROP TABLES

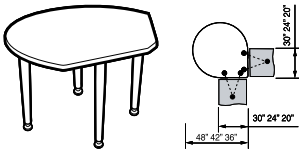

Teardrop 90° Table

B2036TDF	20 x 36 x 29	100	71	8	\$675	\$248
B2442TDF	24 x 42 x 29	100	81	8.50	\$738	\$385
B3048TDF	30 x 48 x 29	100	91	11	\$811	\$358

Freestanding table includes four tapered legs with levellers and Bungee cords. Each table can be "Bungee-tied" to other tables of the same depth. Shipped RTA (ready to assemble). Modesty panels or Filler Modestys are NOT available.

- Available with bubble edge (BB or BS) only.
- Available with optional locking casters, specify option "CS" or "CK".

Required Specifications

Top finish
Edge
Leg finish

Optional Specifications

Casters
High Pressure Laminate

FLAT ROUND TABLES

MODEL# DIMENSIONS FREIGHT CLASS WT/LBS. CUBIC FT. LIST PRICE HP ADD

D x W x H

B2030FRF	20 x 30 x 29	100	56	6	\$656	\$221
B2036FRF	20 x 36 x 29	100	66	7.26	\$656	\$248
B2436FRF	24 x 36 x 29	100	64	7.26	\$656	\$248
B2442FRF	24 x 42 x 29	100	76	8.26	\$781	\$385
B3042FRF	30 x 42 x 29	100	74	8	\$781	\$385
B3048FRF	30 x 48 x 29	100	88	11	\$781	\$351
B3648FRF	36 x 48 x 29	125	85	11	\$863	\$548
B3652FRF	36 x 52 x 29	100	93	11	\$863	\$548

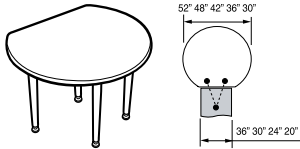

Flat Round Table*

Freestanding table includes four tapered legs with levellers and Bungee cords. Each table can be "Bungee-tied" to other tables of the same depth. Shipped RTA (ready to assemble). Modesty panels or Filler Modestys are NOT available.

- Available with bubble edge (BB or BS) only.
- Available with optional locking casters, specify option "CS" or "CK".

MODESTY PANELS

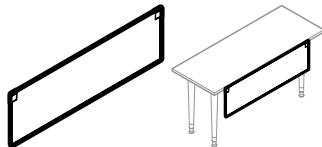

Modesty Panel

BX36QMP	9.5 x 21 x .69	60	3	1.20	\$85	N/A
BX42QMP	9.5 x 27 x .69	60	4	1.35	\$89	N/A
BX48QMP	9.5 x 33 x .69	60	4	1.60	\$94	N/A
BX60QMP	9.5 x 45 x .69	60	5	2.10	\$102	N/A
BX66QMP	9.5 x 51 x .69	60	6	2.60	\$107	N/A
BX72QMP	9.5 x 57 x .69	60	7	2.60	\$112	N/A

For use on **Rectangular** and **Square** Tables. Includes hinged mounting bracket. Available in all Bungee laminate finishes. Edge available in Silver finish (SI) or Black finish (BK).

- Modesty panel model number indicates the width of table to be used on.

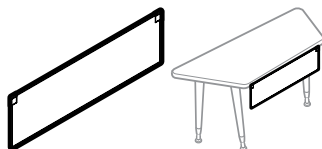

Modesty Panel

BXM60QMP	9.5 x 21 x .69	60	4	1.20	\$89	N/A
BXM66QMP	9.5 x 27 x .69	60	4	1.35	\$94	N/A
BXM72QMP	9.5 x 33 x .69	60	5	1.60	\$98	N/A
BXL60QMP	9.5 x 21 x .69	60	3	1.20	\$87	N/A
BXL66QMP	9.5 x 27 x .69	60	4	1.35	\$89	N/A
BXL72QMP	9.5 x 33 x .69	60	4	1.60	\$94	N/A

For use on **Trapezoid** Tables. Includes hinged mounting bracket. Intended for use on the short side of the table; may be used on long side but leaves a larger gap. Available in all Bungee laminate finishes. Edge available in Silver finish (SI) or Black finish (BK).

- Modesty panel model number indicates the width of table to be used on.
- Specify **BXM** models for 24" D tables and **BXL** models for 30" D tables.

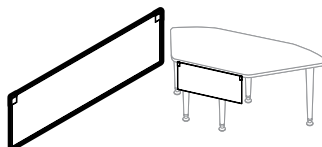

Modesty Panel

BXWQMP	9.5 x 27 x .69	60	4	.40	\$89	N/A
--------	----------------	----	---	-----	-------------	-----

For use on **Wedge** Tables. Includes hinged mounting bracket. Intended for use on the short side of the table. Available in all Bungee laminate finishes. Edge available in Silver finish (SI) or Black finish (BK).

Required Specifications

Top finish
Edge
Leg finish*

Optional Specifications

Casters*
HP laminate*

B BUNGEE™ TABLES

FILLER MODESTY PANELS



Filler Modesty Panel - Straight

MODEL#	DIMENSIONS D x W x H	FREIGHT CLASS	WT/LBS.	CUBIC FT.	LIST PRICE	HP ADD
BSFMS	.06 x 21 x 9	70	1	.30	\$92	N/A

Used to fill the space between two **square** modesty panels where tables are linked in a straight configuration. Available in Silver (**SI**) or Black (**BK**). Please specify.



Filler Modesty Panel - Straight to Wedge

BSWFM	.06 x 21 x 9	100	1	1.5	xx	N/A
-------	--------------	-----	---	-----	----	-----

Used to fill the space between a straight modesty panel and a wedge table. Use for regular wedge table - tapered legs and flip-top wedge - spider legs. Available in Silver (**SI**) or Black (**BK**). Please specify.

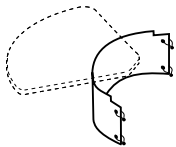

Filler Modesty Panel - Inside Curve

B23IFMS	.06 x 23 x 9	250	3	1.50	\$111	N/A
B29IFMS	.06 x 29 x 9	250	3	1.50	\$111	N/A
B30IFMS	.06 x 30 x 9	250	3	1.50	\$111	N/A

Used to fill the space (inside curve) between two modesty panels where tables are linked at an angle or curve. Use for the inside curve of Round Wedge Tables, Teardrop Tables, or Trapezoid Tables. Available in Silver (**SI**) or Black (**BK**). Please specify.

- Use model **B23IFMS** for Trapezoid Tables inside curve only.
- Use model **B29IFMS** for Teardrop Tables inside curve only.
- Use model **B30IFMS** for Round Wedge Tables inside curve only.

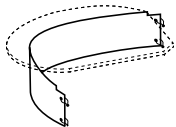

Filler Modesty Panel - Outside Curve

B56S	.06 x 56 x 9	250	4	1.50	\$161	N/A
B62S	.06 x 62 x 9	250	4	1.50	\$173	N/A
B71S	.06 x 71 x 9	250	4	1.50	\$210	N/A

Used to fill the space (outside curve) between two modesty panels where tables are linked at an angle or curve. Use for Teardrop Tables only (**B2036TDF**, **B2442TDF** and **B3048TDF**). Available in Silver (**SI**) or Black (**BK**). Please specify.

- Use model **B56S** for **B2036TDF** Teardrop Tables outside curve only.
- Use model **B62S** for **B2442TDF** Teardrop Tables outside curve only.
- Use model **B71S** for **B3048TDF** Teardrop Tables outside curve only.

Required Specifications

Finish

WIRE MANAGEMENT

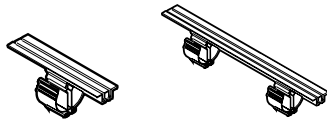

Wire Management - 5" /22" Track

MODEL#	DIMENSIONS D x W x H	FREIGHT CLASS	WT/LBS.	CUBIC FT.	LIST PRICE	HP ADD
BWMS5	2 x 5 x 3.5	70	1	.10	\$11	N/A
BWMD22	2 x 22 x 3.5	70	1	.10	\$17	N/A

Retrofittable track mounts to the underside of worksurface. Includes wire clamp that can route data and voice wires separately. Black only.

- For a 5" track, order model **BWMS5** - includes one wire clamp.
- For a 22" track, order model **BWMD22** - includes two wire clamps.

BOARDROOM TABLE SETS

11 Foot Configurations

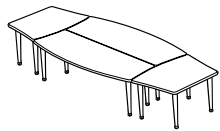

Boardroom Table Set - 11 foot

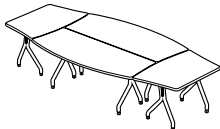

Boardroom Table Set - 11 foot

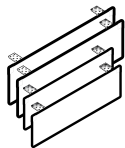

Modesty Panel Set for Boardroom Table

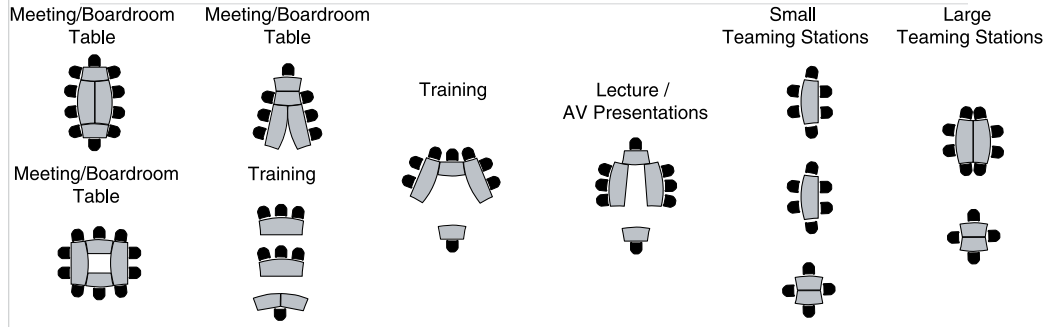

BK132F	60 x 132 x 29	85	290	19.25	\$3175	\$1207
--------	---------------	----	-----	-------	---------------	---------------

Set includes four freestanding tables with **tapered legs** and Bungee cords for tool free ganging. Leg finish or legs with casters optional, see page 604 . Shipped easy to assemble in 6 cartons. Modesty panel set available, order **BXK132QMP**.

- Due to the unique geometry of the tables, all edge types will feature rounded corners.

BK132S	60 x 132 x 29	85	290	22.25	\$3563	\$1207
--------	---------------	----	-----	-------	---------------	---------------

Set includes four freestanding tables with **spider legs** and Bungee cords for tool free ganging. Leg finish or legs with casters optional, see page 604 . Shipped easy to assemble in 6 cartons. Modesty panel set available, order **BXK132QMP**.

- Due to the unique geometry of the tables, all edge types will feature rounded corners.

BXK132QMP	.69 x 34 x 9	92.5	13	1.10	\$347	N/A
-----------	--------------	------	----	------	--------------	-----

For use on **11 foot Boardroom Table Set**. Includes mounting bracket and wire access sweep. Available in all Bungee laminate finishes.

Required Specifications

Top finish
Edge
Leg finish

Optional Specifications

Casters
Grommet
Modesty panel
HP laminate

B BUNGEE™ TABLES

BOARDROOM TABLE SETS

13/15 Foot Configurations

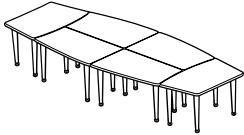

Boardroom Table Set - 13 and 15 foot

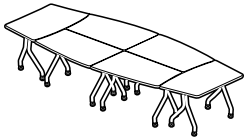

Boardroom Table Set - 13 and 15 foot

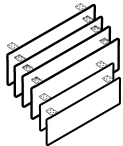

Modesty Panel Set for Boardroom Table

MODEL#	DIMENSIONS D x W x H	FREIGHT CLASS	WT/LBS.	CUBIC FT.	LIST PRICE	HP ADD
Meeting/Boardroom Table	Lecture / AV Presentations	Training			Small Teaming Stations	Large Teaming Stations
Meeting/Boardroom Table	Lecture / AV Presentations	Meeting/Boardroom Table	Training		Small Teaming Stations	
BK156F	60 x 156 x 29	85	374	26.25	\$4673	\$1532
BK180F	60 x 180 x 29	100	420	29.75	\$5093	\$1750

Set includes six freestanding tables with **tapered legs** and Bungee cords for tool free ganging. Leg finish or legs with casters optional, see page 604 . Shipped easy to assemble in 9 cartons. Modesty panel set available, order **BK156QMP/ BK180QMP**.

- Due to the unique geometry of the tables, all edge types will feature rounded corners.

BK156S	60 x 156 x 29	85	374	28.75	\$4823	\$1532
BK180S	60 x 180 x 29	70	420	32.50	\$5229	\$1750

Set includes six freestanding tables with **spider legs** and Bungee cords for tool free ganging. Leg finish or legs with casters optional, see page 604 . Shipped easy to assemble in 9 cartons. Modesty panel set available, order **BK156QMP/ BK180QMP**.

- Due to the unique geometry of the tables, all edge types will feature rounded corners.

BXK156QMP	.69 x 34 x 9	70	20	1	\$588	N/A
BXK180QMP	.69 x 46 x 9	65	25	1.10	\$564	N/A

For use on **13 & 15 foot Boardroom Table Set**. Includes mounting bracket and wire access sweep. Available in all Bungee laminate finishes. Edge available in Silver finish (**SI**) or Black finish (**BK**).

- Use model **BXK156QMP** for **BK156F/S** Boardroom Table Set.
- Use model **BXK180QMP** for **BK180F/S** Boardroom Table Set.

Required Specifications

Top finish
Edge
Leg + caster finish

Optional Specifications

Grommet
Modesty panel
HP laminate

Accessories

Power block

RECTANGULAR TABLE - FLIP TOP

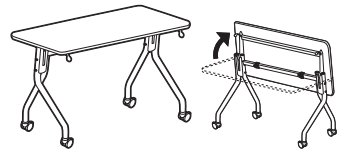
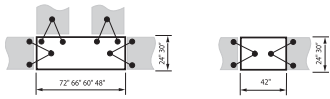

Flip-Top Rectangular Table - Spider Legs

MODEL#	DIMENSIONS	FREIGHT CLASS	WT/LBS.	CUBIC FT.	LIST PRICE	HP ADD
D x W x H						
BX2442RES	24 x 42 x 29	250	66	20.75	\$1167	\$173
BX2448RES	24 x 48 x 29	250	72	23.50	\$1184	\$173
BX2460RES	24 x 60 x 29	250	84	29	\$1212	\$217
BX2466RES	24 x 66 x 29	250	97	31.75	\$1222	\$259
BX2472RES	24 x 72 x 29	250	102	34.75	\$1245	\$259
BX3042RES	30 x 42 x 29	250	73	25.50	\$1167	\$217
BX3048RES	30 x 48 x 29	250	73	28.75	\$1184	\$217
BX3060RES	30 x 60 x 29	250	94	35.75	\$1217	\$270
BX3066RES	30 x 66 x 29	250	106	39.25	\$1229	\$324
BX3072RES	30 x 72 x 29	250	112	42.50	\$1256	\$324

Table features a flip-top worksurface for ease of storage. Single hand release mechanism can be activated from left or right side of the table. Tables can be nested when folded. Each table can be "Bungee-tied" to other tables of the same depth. Folding modesty panels available, see next page.

- **Tables 48" and longer connect in both Straight and "L" configurations**
- **Standard with locking casters**
- **Due to hardware placement, tables placed in back-to-back configurations will not be able to be "Bungee-tied" together.**

TRAPEZOID TABLES - FLIP TOP

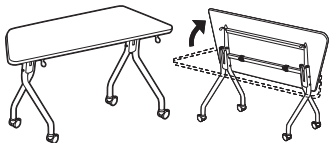
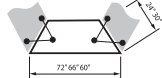

Flip-Top Trapezoid Table - Spider Legs

BX2460TRS	24 x 60 x 29	150	112	28	\$1095	\$217
BX2466TRS	24 x 66 x 29	250	112	31	\$1113	\$259
BX2472TRS	24 x 72 x 29	250	112	33	\$1128	\$259
BX3060TRS	30 x 60 x 29	250	112	35.50	\$1119	\$270
BX3066TRS	30 x 66 x 29	250	112	39	\$1135	\$324
BX3072TRS	30 x 72 x 29	250	112	42.50	\$1151	\$324

Table features a flip-top worksurface for ease of storage. Single hand release mechanism can be activated from left or right side of the table. Tables can be nested when folded. Each table can be "Bungee-tied" to other tables of the same depth. Folding modesty panels available, see next page.

- **Available with bubble edge (BB or BS) only.**
- **Standard with locking casters**

KEYSTONE TABLES - FLIP TOP

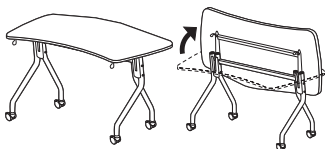

Flip-Top Keystone Table - Spider Legs

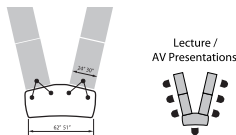

BX24KSS	24 x 51 x 29	125	112	16.50	\$1090	\$217
BX30KSS	30 x 62 x 29	125	112	16.50	\$1135	\$324

Table features a flip-top worksurface for ease of storage. Single hand release mechanism can be activated from left or right side of the table. Tables can be nested when folded. Each table can be "Bungee-tied" to other tables of the same depth.

- **Modesty panels or Filler Modestys are NOT available.**
- **Standard with locking casters**

Required Specifications

Top finish
Edge
Leg + caster finish

Optional Specifications

Grommet
Modesty panel
HP laminate

Accessories

Power block

B BUNGEE™ TABLES

WEDGE TABLES - FLIP TOP

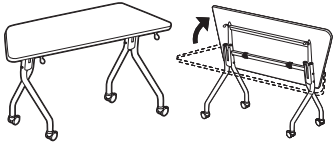

Flip-Top Wedge Table - Spider Legs

MODEL#	DIMENSIONS D x W x H	FREIGHT CLASS	WT/LBS.	CUBIC FT.	LIST PRICE	HP ADD
BX24WES	24 x 63 x 29	60	76	33	\$1372	\$311
BX30WES	30 x 70 x 29	60	84	33	\$1394	\$311

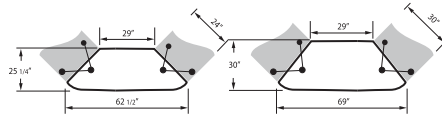
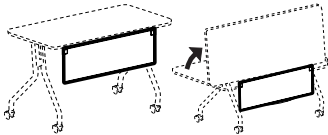

Table features a flip-top worksurface for ease of storage. Single hand release mechanism can be activated from left or right side of the table. Tables can be nested when folded. Each table can be “Bungee-tied” to other tables of the same depth. Folding modesty panels available, see below.

- Standard with locking casters

MODESTY PANELS - FLIP TOP



Modesty Panel

BX36QMP	9.5 x 21 x .69	60	3	1.20	\$85	N/A
BX42QMP	9.5 x 27 x .69	60	4	1.35	\$89	N/A
BX48QMP	9.5 x 33 x .69	60	4	1.60	\$94	N/A
BX60QMP	9.5 x 45 x .69	60	5	2.10	\$102	N/A
BX66QMP	9.5 x 51 x .69	60	6	2.60	\$107	N/A
BX72QMP	9.5 x 57 x .69	60	7	2.60	\$112	N/A

For use on **Flip Top Rectangular Tables**. Includes hinged mounting bracket. Available in all Bungee laminate finishes. Edge available in Silver finish (**SI**) or Black finish (**BK**).

- Modesty panel model number indicates the width of table to be used on.

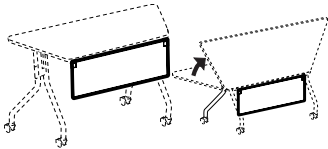

Modesty Panel

BXM60QMP	9.5 x 21 x .69	60	4	1.20	\$89	N/A
BXM66QMP	9.5 x 27 x .69	60	4	1.35	\$94	N/A
BXM72QMP	9.5 x 33 x .69	60	5	1.60	\$98	N/A
BXL60QMP	9.5 x 21 x .69	60	3	1.20	\$87	N/A
BXL66QMP	9.5 x 27 x .69	60	4	1.35	\$89	N/A
BXL72QMP	9.5 x 33 x .69	60	4	1.60	\$94	N/A

For use on **Flip Top Trapezoid Tables**. Includes hinged mounting bracket. Intended for use on the short side of the table; may be used on long side but leaves a larger gap. Available in all Bungee laminate finishes. Edge available in Silver finish (**SI**) or Black finish (**BK**).

- Modesty panel model number indicates the width of table to be used on.
- Specify **BXM** models for 24”D tables and **BXL** models for 30”D tables.

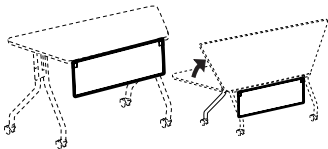

Modesty Panel

BXWQMP	9.5 x 27 x .69	60	4	.40	\$89	N/A
--------	----------------	----	---	-----	-------------	-----

For use on **Flip Top Wedge Tables**. Includes hinged mounting bracket. Intended for use on the short side of the table. Available in all Bungee laminate finishes. Edge available in Silver finish (**SI**) or Black finish (**BK**).

- Modesty panel model number indicates the width of table to be used on.

Required Specifications

Top finish
Edge
Leg + caster finish

Optional Specifications

Grommet
Modesty panel
HP laminate

Accessories

Power block

BOARDROOM TABLE SET - FLIP TOP

MODEL#

DIMENSIONS

FREIGHT CLASS

WT./LBS.

CUBIC FT.

LIST PRICE

HP ADD

D x W x H

4 pc. Configurations

Meeting/Boardroom Table



Meeting/Boardroom Table



Training



Lecture / AV Presentations

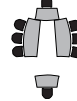

Small Teaming Stations



Large Teaming Stations



Meeting/Boardroom Table



Training



BXK132S

60 x 132 x 29

250

352

151.25

\$4486

\$1234



Boardroom Table Set - 4pc. Flip Top

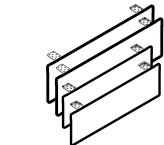
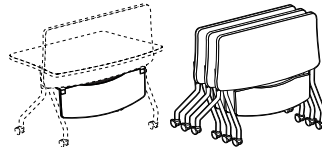

Square Modesty Panel Set for 4pc. Flip Top Table

BXK132QMP

.69 x 34 x 9

92.5

13

1.10

\$347

N/A

For use on 4 pc. flip top table kits. Modesty panels flip down for storage. Features black wire access sweep. Available in all Bungee laminate finishes. Edge available in Silver finish (SI) or Black finish (BK).

Required Specifications

- Top finish
- Edge
- Leg + caster finish

Optional Specifications

- HP laminate

B BUNGEE™ TABLES

MODESTY PANEL SETS

6 pc. Configurations

MODEL#	DIMENSIONS D x W x H	FREIGHT CLASS	WT./LBS.	CUBIC FT.	LIST PRICE	HP ADD

BXK156S	60 x 156 x 29	250	452	181.75	\$6642	\$1423
BXK180S	60 x 180 x 29	250	507	209.50	\$6803	\$1638



Boardroom Table Set - 6pc. Flip Top

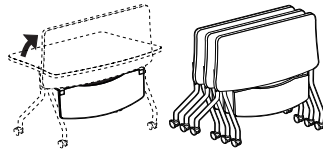

Set includes six freestanding tables with **spider legs** and Bungee cords for tool free ganging. Only legs with casters available, see page 604 for finish choices. All tables feature a flip top worksurface for ease of storage. Single hand release mechanism can be activated from left or right side of table. Tables can be nested when folded. Shipped in 6 cartons. Modesty panel set available, order **BXK156QMP/ BXK180QMP**.

• **Due to the unique geometry of the tables, all edge types will feature rounded corners.**

BXK156QMP	.69 x 34 x 9	70	20	1	\$588	N/A
BXK180QMP	.69 x 46 x 9	65	25	1.10	\$564	N/A

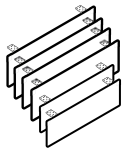

Square Modesty Panel Set for 6 pc. Flip Top Table

For use on **6 pc. flip top table kits**. Modesty panels flip down for storage. Features black wire access sweep. Available in all Bungee laminate finishes. Edge available in Silver finish (**SI**) or Black finish (**BK**).

Required Specifications

Top finish
Edge
Leg + caster finish

Optional Specifications

Grommet

Accessories

Power block

ACCESSORIES

MODEL# DIMENSIONS FREIGHT CLASS WT/LBS. CUBIC FT. LIST PRICE HP ADD

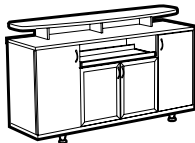

Credenza Buffet

	D x W x H					
B2072BUF	20 x 72 x 42	100	305	37.50	\$2769	\$407

Pull-out shelf. Top transaction shelf is edged with bubble molding. Side storage compartments feature a laminate door and one adjustable shelf each. Center storage features frosted aluminum doors with one adjustable shelf. Leveler feet are standard.

- Some assembly required.

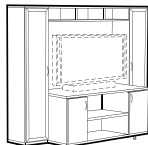

Audio/Visual Cabinet

B249072AV	24 x 90 x 72	92.5	530	52.52	\$4566	\$411
-----------	--------------	------	-----	-------	--------	-------

Top pigeon holes and center adjustable shelf accommodate electronic equipment, CDs and other media. Bottom storage compartments feature laminate doors and one adjustable shelf. Side storage towers feature frosted aluminum doors with three adjustable shelves each. Accommodates TVs up to 58" w x 34" h x 24" d.

- Some assembly required.



Lectern

B44LEC	17 x 22 x 44	250	36	12.50	\$694	\$132
--------	--------------	-----	----	-------	-------	-------

Features angled stand with pencil ledge. Locking casters. **Specify CS or CK.**

Required Specifications

Top finish
Edge
Leg finish

Optional Specifications

Grommet

Accessories

Power block

B BUNGEE SL™ - NOTES



BUNGEE SL - a completely new product line to complement and coordinate with the Bungee Training Tables series. Bungee SL takes the popular aesthetic of the Bungee series and allows tables to be specified in shared leg and permanent applications - great for training, teaming and academic areas. Bungee SL tops and legs are sold separately, increasing the flexibility of the product in the future and allows for space saving in areas where real estate is a premium.

For greater flexibility, specify **Power and Data Management Troughs** for the BUNGEE SL table series. Add Global's proprietary 4-wire power kits and create inexpensive and versatile training, benching, academic and meeting areas. Front panels are available in Laminate or Aluminum. A center spine version allows for inexpensive double-sided applications.

Features and Benefits

- Tops are 1" thick with a choice of four edges: BB/BS - Bungee bubble edge, AB/AS - split color edge, A3 - matching edge and AR - Bicut edge.
- Legs are offered in Tapered or Spider design in a Silver or Black finish. Levelers are standard
- Power and data management troughs are sold separately and are meant to be used on BUNGEE SL only.



Tapered leg with levelers, offered in Silver or Black finish.



Optional power and data management troughs for Bungee SL. Center spine shown.



Shared leg, back-to-back tables with center spine trough.

GENERAL INFORMATION

- Introducing **BUNGEE SL** - a completely new product line to complement and coordinate with the top selling Bungee Training Tables series.
- Bungee SL takes the popular aesthetic of the Bungee series and allows tables to be specified in shared leg and permanent applications - great for benching, training, teaming and academic areas.
- Bungee SL tops and legs are sold separately, increasing the flexibility of the product in the future and allows for space saving in areas where real estate is a premium.
- High pressure tops are available in all BUNGEE SL laminates at an extended lead time - please refer to model # for pricing.
- Global laminate and seating products are in compliance with stringent emission guidelines set out by UL/Greenguard Environmental Institute under the standards for low emitting products and materials. www.greenguard.org
- **Level 3 Certified**

CONSTRUCTION

- Tops are 1" thick
- All laminate components are made of 45 lb. density particleboard with high performance thermally fused laminate.
- Tops 60" and over feature a built-in support bar. The support bar is 10" from the **approach** side, and clearance to the bottom of the support bar is 27" from the floor.
- **BUNGEE CORDS ARE NOT INCLUDED AND ARE NOT COMPATIBLE WITH BUNGEE SL TOPS**
- Products specified with the high pressure laminate option are finished on the underside of the surface with a kraft paper backing.

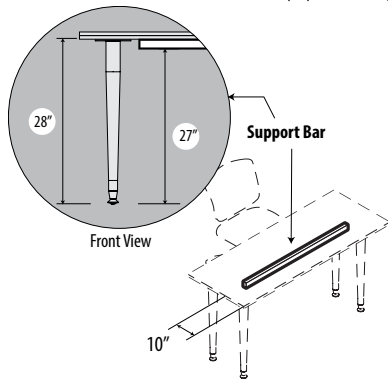

EDGE DETAIL

- Bungee SL comes with a choice of four edge styles:



A3 - square corner, standard edge



AR - square corner, bicut edge



AS - square corner, Silver



AB - square corner, Black



BS - rounded corner, Silver



BB - rounded corner, Black

- **BB/BS** - Bungee Bubble Edge: unique "bubble" molding found on original Bungee
- **AB/AS** - Split color PVC edge: edge matches split color aesthetic of the bubble edge, but allows for 90 degree corners and a cleaner look.
- **A3** - Global's preferred edge. Coordinates well with Adaptabilities and Zira 1" tops.
- **AR** - Bicut edge. Coordinates well with Zira 1" tops.

LEGS

- Two leg styles are available - Tapered and Spider leg. Available in Silver (**SI**) or Black (**BK**) finish. Levelers are standard; casters are not available for Bungee SL legs. Levelers adjust 3mm - 10mm in height.

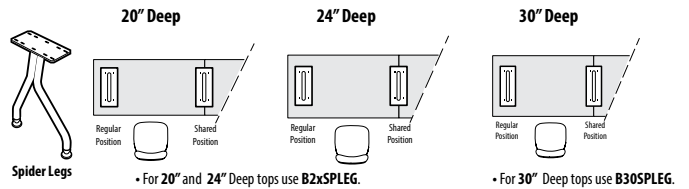

MODESTY PANELS

- See **POWER AND DATA MANAGEMENT TROUGHS** - page 627
- For modesty panels without power and data management, please see **Bungee modesty panels**, found on page 595

WIRE MANAGEMENT / POWER OPTIONS

- **TO UTILIZE BUNGEE SL TO THE FULLEST EXTENT, SPECIFY POWER AND DATA MANAGEMENT TROUGH (SEE PAGE 627).**
- For basic wire management, see details on page 595.

1. SPECIFY MODEL NUMBER

2. SPECIFY FINISH

Laminate Finishes:

ACJ	Absolute Acajou	HGT	Hayden Grey
ASN	Asian Night	QTM	Quartered Mahogany
AWC	Avant Cherry	SOG	Storm Grey
AWH	Avant Honey	TFW	Tiger Fruitwood
BLK	Black	TWL	Tiger Walnut
BRC	Brushed Cobalt	WHE	Walnut Heights
CMB	Clear Maple	WHC	White Chocolate
DES	Dark Espresso	WCR	Winter Cherry
DWT	Designer White	WGY	Willow Grey

Edge:

BB	Bungee bubble edge with Black trim
BS	Bungee bubble edge with Silver trim
AB	Split color edge with Black trim
AS	Split color edge with Silver trim
A3	Matching edge
AR	Matching bicut edge

Legs:

SI	Silver
BK	Black

3. SPECIFY OPTIONS

GROMMETS

- Optional Grommets available in standard worksurface locations (left, center or right) **for rectangular tops 48" and up**. Order as: **AG1, AG2 or AG3 - Add \$69**
- Optional grommets are available in **center position only for rectangular tops** (36" and 42"), **keystone, half moon and wedge tops**. Order as **AG2 - Add \$69**.
- Grommet hole dimensions are 3.25" wide x 1.875" deep.
- Grommets may be placed at non-standard locations. Order as: **AGS - Add \$69**. A drawing must be supplied with vertical and horizontal dimensions to the center of the cut-out (as in drawing below). Please refer to CUSTOM GROMMET LOCATION FORM in the back reference section.

Grommet hole dimensions

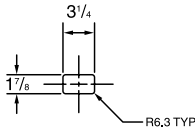

Grommet

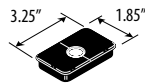

Keystone

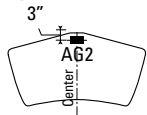

Half Moon

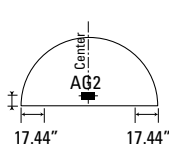

Wedge

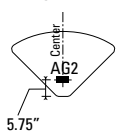

Rectangular Tops

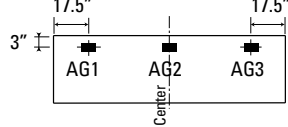
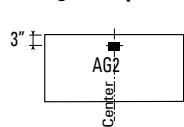

For 36" and 42" wide units

For 48", 60" and 72" wide units

POWER BLOCK

- A Power Block is a rectangular worksurface power/data module with one electrical duplex receptacle and two data (RJ45) receptacles. 9' black cord included. Power block dimensions are 3.5"D x 6.5"W x 2.75"H. Power block cutout dimensions are 2.75"D x 6"W.
- A power block cutout (model **PMSPDM**) may be ordered for **rectangular tops** (48" and up) in place of standard grommets. Order as **E1, E2 or E3. Add \$69**.
- A power block cutout (model **PMSPDM**) may be ordered in the **center position only for rectangular tops** (36" and 42"), **keystone and half moon tops**. Order as **E2. Add \$69**.

- To purchase a power block, you must specify both the power block cut-out location and the power block model #. Order power block separately as **PMSPDM, Add \$261**.

Keystone

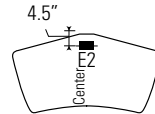

Half Moon

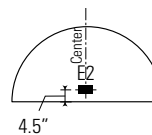

Power Block

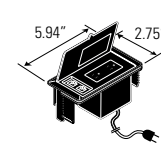

Rectangular Tops

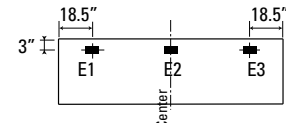
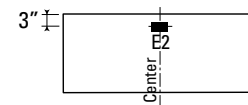

For 36", 42" and 48" wide units

For 60" and 72" wide units

VILLA POWER BLOCK (CORDED VERSION ONLY)

- A Villa power block (corded) is available in four options (see page 633 for Villa Corded details). Villa power block (corded) dimensions vary by model. Villa cutout dimensions are 3"D x 5.25"W.
- A Villa cutout may be ordered for **rectangular tops 48" and up**. Order as: **V1, V2 or V3 - Add \$69 for each cutout**.
- A Villa cutout may be ordered in the **center position only for rectangular tops** (36" and 42"), **keystone and half moon tops**. Order as: **V2 - Add \$69**.
- Order Villa Power Block and Villa Grommet Cover separately, see page 633 for pricing and details.

Keystone

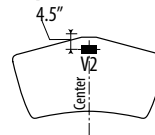

Half Moon

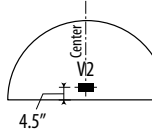

Villa Power Block

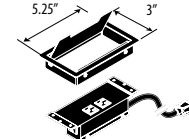

Rectangular Tops

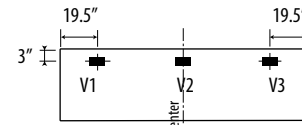
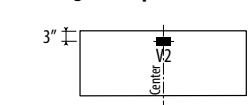

For 36", 42" and 48" wide units

For 60" and 72" wide units

TOPS WITH SQUARE CORNERS (A3, AR OR AB/AS EDGE) MODEL# DIMENSIONS FREIGHT CLASS WT/LBS. CUBIC FT. LIST PRICE HP ADD

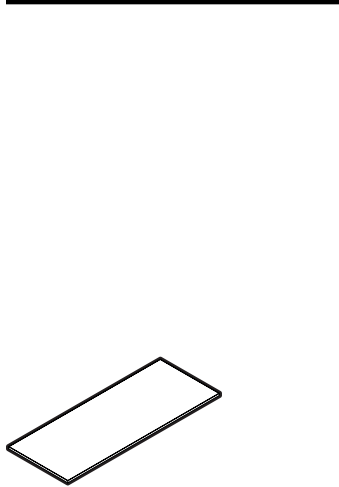

Rectangular Top - Square Corners

	D x W x H						
BS3072REC	30 x 72 x 1	70	60	4	\$431	\$370	
BS3060REC	30 x 60 x 1	70	53	3.40	\$360	\$308	
BS3048REC	30 x 48 x 1	70	46	2.70	\$220	\$247	
BS3042REC	30 x 42 x 1	70	42	2.40	\$215	\$217	
BS3036REC	30 x 36 x 1	70	38	2.10	\$171	\$186	
BS2472REC	24 x 72 x 1	70	51	3.30	\$377	\$296	
BS2460REC	24 x 60 x 1	70	44	2.80	\$329	\$247	
BS2448REC	24 x 48 x 1	70	37	2.30	\$187	\$198	
BS2442REC	24 x 42 x 1	70	33	2	\$177	\$174	
BS2436REC	24 x 36 x 1	70	29	1.80	\$167	\$149	
BS2072REC	20 x 72 x 1	85	43	2.90	\$350	\$247	
BS2060REC	20 x 60 x 1	70	37	2.40	\$296	\$208	
BS2048REC	20 x 48 x 1	70	30	2	\$176	\$174	
BS2042REC	20 x 42 x 1	70	27	1.80	\$162	\$149	
BS2036REC	20 x 36 x 1	70	24	1.50	\$152	\$149	

Rectangular 1" thick worksurface with **Square Corners**. Can accept Tapered (B29TPLEG) or Spider Legs (B2XSPLEG / B30SPLEG) in "end of run" or shared leg positions. Tops 60" and up include a built-in support bar. Shipped RTA (ready to assemble). Compatible with **power and data management troughs** (see page 627) or standard modesty panels (see page 573).

- For worksurfaces to be used as a return, please see Return Tops.
- Legs sold separately.

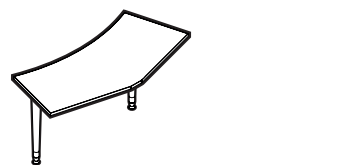

Keystone Top - Square Corners

BS30KSF	30.50 x 62.75 x 29	92.5	37	3.60	\$835	\$370
BS24KSF	28.75 x 52 x 29	92.5	29	2.80	\$773	\$271
BS20KSF	27.75 x 44 x 29	92.5	25	2.40	\$763	\$223

1" thick worksurface with **Square Corners**. Includes (2) Tapered legs. *Not available with Spider Legs*. Connects to other tops of 20", 24" or 30" depths. Shipped RTA (ready to assemble). Modesty panels or filler panels are NOT available.

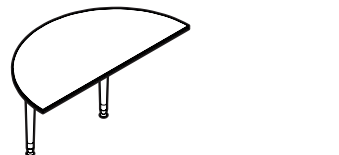

Half Moon Top - Square Corners

BS3060HMF	29.75 x 59.4 x 29	92.5	36	3.30	\$718	\$308
BS2448HMF	24 x 48.2 x 29	92.5	24	2.30	\$675	\$198

1" thick worksurface with **Square Corners**. Includes (2) Tapered legs. *Not available with Spider Legs*. Connects to other tables equaling the same length. Shipped RTA (ready to assemble). Modesty panels or filler panels are NOT available.

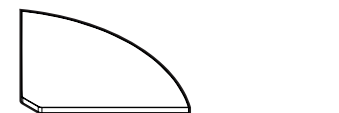

90° Wedge Top - Square Corners

BS24WE	26.8 x 26.8 x 1	92.5	15	1.50	\$208	\$174
BS20WE	22.8 x 22.8 x 1	100	10	1.20	\$152	\$149

1" thick worksurface with **Square Corners**. Can accept Tapered (B29TPLEG) or Spider Legs (B2XSPLEG / B30SPLEG) in shared positions only. Shipped RTA (ready to assemble). Accepts filler modesty panels.

- Legs sold separately.

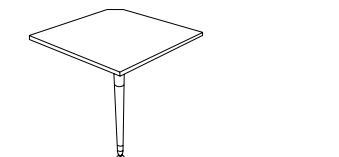

90° Corner - Square Corners

BS30CN	33.17 x 33.17 x 29	125	36	2.50	\$468	\$144
--------	--------------------	-----	----	------	-------	-------

Connects to 30" Deep Rectangular Tables. Includes (1) Tapered leg. *Not available with Spider Legs*.

Required Specifications

Top Finish
Top / Edge Detail

Optional Specifications

Grommet
Power/Data Management Troughs -
(Rectangular tops only)
Modesty Panel (Rectangular tops only)

HP Laminate

Accessories

Power Block
Villa Power Block (Corded)

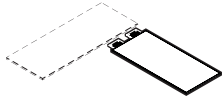

Rectangular Return Tops - Square Corners

MODEL#	DIMENSIONS D x W x H	FREIGHT CLASS	WT/LBS.	CUBIC FT.	LIST PRICE	HP ADD
BS3054RRE	30 x 54 x 1	70	50	3.10	\$235	\$278
BS3048RRE	30 x 48 x 1	70	46	2.70	\$220	\$247
BS3042RRE	30 x 42 x 1	70	42	2.40	\$215	\$217
BS3036RRE	30 x 36 x 1	70	38	2.10	\$171	\$186
BS2454RRE	24 x 54 x 1	70	40	2.50	\$202	\$223
BS2448RRE	24 x 48 x 1	70	37	2.30	\$187	\$198
BS2442RRE	24 x 42 x 1	70	33	2	\$177	\$174
BS2436RRE	24 x 36 x 1	70	29	1.80	\$167	\$149
BS2054RRE	20 x 54 x 1	70	33	2.20	\$192	\$186
BS2048RRE	20 x 48 x 1	70	30	2	\$176	\$166
BS2042RRE	20 x 42 x 1	70	27	1.80	\$162	\$149
BS2036RRE	20 x 36 x 1	70	24	1.50	\$152	\$124

Rectangular 1" thick worksurface with **Square Corners**. Includes two flat brackets to attach to another worksurface on one end. Can accept Tapered (B29TPLEG) or Spider Legs (B2XSPLEG / B30SPLEG) on the other end. 54" tops include a built-in support bar. Shipped RTA (ready to assemble). Compatible with standard modesty panels (see page 603).

- For worksurfaces to be used as a main surface, please see Rectangular Tops.
- Legs sold separately.

TOPS WITH ROUNDED CORNERS (BB/BS EDGES ONLY)



Rectangular Top - Rounded Corners

BB3072REC	30 x 72 x 1	85	59	4	\$553	\$370
BB3060REC	30 x 60 x 1	70	52	3.40	\$462	\$308
BB3048REC	30 x 48 x 1	70	45	2.70	\$281	\$247
BB3042REC	30 x 42 x 1	70	41	2.40	\$274	\$217
BB3036REC	30 x 36 x 1	70	37	2.10	\$221	\$186
BB2472REC	24 x 72 x 1	70	50	3.30	\$485	\$296
BB2460REC	24 x 60 x 1	70	43	2.80	\$421	\$247
BB2448REC	24 x 48 x 1	70	36	2.30	\$238	\$198
BB2442REC	24 x 42 x 1	70	32	2	\$228	\$174
BB2436REC	24 x 36 x 1	70	28	1.80	\$215	\$149
BB2072REC	20 x 72 x 1	85	42	2.90	\$449	\$247
BB2060REC	20 x 60 x 1	70	36	2.40	\$380	\$208
BB2048REC	20 x 48 x 1	85	29	2	\$226	\$174
BB2042REC	20 x 42 x 1	85	26	1.80	\$208	\$149
BB2036REC	20 x 36 x 1	70	23	1.50	\$194	\$149

Rectangular 1" thick worksurface with **Rounded Corners**. Can accept Tapered (B29TPLEG) or Spider Legs (B2XSPLEG / B30SPLEG) in "end of run" or shared leg positions. Tops 60" and up include a built-in support bar. Shipped RTA (ready to assemble). Compatible with **power and data management troughs** (see page 627) or standard modesty panels (see page 603).

- For worksurfaces to be used as a return, please see Return Tops
- Legs sold separately.

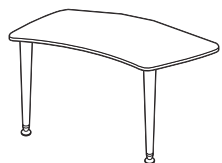

Keystone Top - Rounded Corners

BB30KSF	30.50 x 62.75 x 29	92.5	36	3.60	\$835	\$370
BB24KSF	28.75 x 52 x 29	92.5	28	2.80	\$773	\$271
BB20KSF	27.75 x 44 x 29	92.5	24	2.40	\$763	\$223

1" thick worksurface with **Rounded Corners**. Includes (2) Tapered legs. *Not available with Spider Legs*. Connects to other tops of 20", 24" or 30" depths. Shipped RTA (ready to assemble). Modesty panels or filler panels are NOT available.

Required Specifications

Top Finish
Top / Edge Detail

Optional Specifications

Grommet
Power/Data Management Troughs -
(Rectangular tops only)
Modesty Panel

HP Laminare

Accessories

Power Block
Villa Power Block (Corded)

MODEL#	DIMENSIONS	FREIGHT CLASS	WT/LBS.	CUBIC FT.	LIST PRICE	HP ADD
--------	------------	---------------	---------	-----------	------------	--------

D x W x H

BB3060HMF	29.75 x 59.4 x 29	92.5	35	3.30	\$718	\$308
BB2448HMF	24 x 48.2 x 29	92.5	23	2.30	\$675	\$198

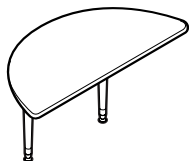

Half Moon Top - Rounded Corners

1" thick worksurface with **Rounded Corners**. Includes (2) Tapered legs. *Not available with Spider Legs*. Connects to other tables equaling the same length. Shipped RTA (ready to assemble). Modesty panels or filler panels are NOT available.

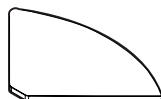

90° Wedge Top - Rounded Corners

BB24WE	26.8 x 26.8 x 1	100	14	1.50	\$266	\$174
BB20WE	22.8 x 22.8 x 1	125	9	1.20	\$194	\$149

1" thick worksurface with **Rounded Corners**. Can accept Tapered (B29TPLEG) or Spider Legs (B2XSPLEG / B30SPLEG) in shared positions only. Shipped RTA (ready to assemble). Accepts filler modesty panels.

- Legs sold separately.

BB3054RRE	30 x 54 x 1	70	50	3.06	\$302	\$278
BB3048RRE	30 x 48 x 1	70	46	2.75	\$281	\$247
BB3042RRE	30 x 42 x 1	70	42	2.44	\$274	\$217
BB3036RRE	30 x 36 x 1	70	38	2.13	\$221	\$186

BB2454RRE	24 x 54 x 1	70	40	2.54	\$259	\$223
BB2448RRE	24 x 48 x 1	70	37	2.28	\$238	\$198
BB2442RRE	24 x 42 x 1	70	33	2.03	\$228	\$174
BB2436RRE	24 x 36 x 1	70	29	1.77	\$215	\$149

BB2054RRE	20 x 54 x 1	70	33	2.20	\$246	\$186
BB2048RRE	20 x 48 x 1	70	30	1.97	\$226	\$166
BB2042RRE	20 x 42 x 1	70	27	1.75	\$208	\$149
BB2036RRE	20 x 36 x 1	70	24	1.53	\$194	\$124

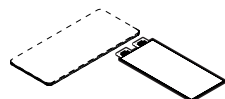

Rectangular Return Tops - Rounded Corners

Rectangular 1" thick worksurface with **Rounded Corners**. Includes two flat brackets to attach to another worksurface on one end. Can accept Tapered (B29TPLEG) or Spider Legs (B2XSPLEG / B30SPLEG) on the other end. 54" tops include a built-in support bar. Shipped RTA (ready to assemble). Compatible with standard modesty panels (see page 573).

- For worksurfaces to be used as a main surface, please see Rectangular Tops
- Legs sold separately.

BB30CN	33.17 x 33.17 x 29	125	36	2.50	\$503	\$144
--------	--------------------	-----	----	------	--------------	--------------

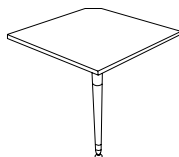

90° Corner - Rounded Corners

Connects to 30" Deep Rectangular Tables. Includes (1) Tapered leg. *Not available with Spider Legs*.

B30SPLEG	25 x 6 x 28	150	16	2.90	\$302	
----------	-------------	-----	----	------	--------------	--



Spider Legs for 30"D Tables

Spider leg with levers. Shipped/sold one per carton. **Tops sold separately.**

- Available in Silver - **SI** or Black - **BK**. Please specify.
- **To be used with 30"D tops only**

Required Specifications

Top Finish
Top / Edge Detail

Optional Specifications

Grommet
Filler Modesty Panel (Wedge Tops only)
Modesty Panel (Rectangular Return Tops)
HP Laminate

Accessories

Power Block
Villa Power Block (Corded)

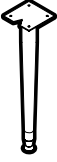
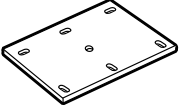
	MODEL#	DIMENSIONS	FREIGHT CLASS	WT/LBS.	CUBIC FT.	LIST PRICE
 <p>Spider Legs for 20" & 24" D Tables</p>		D x W x H				
	B2XSPLEG	20 x 6 x 28	125	14	2.20	\$260
<p>Spider leg with levellers. Shipped/sold one per carton. Tops sold separately.</p> <ul style="list-style-type: none"> • Available in Silver - SI or Black - BK. Please specify. • To be used with 24" & 24" deep tops only 						
 <p>Tapered Leg</p>						
	B29TPLEG	6 x 6 x 28	85	11	.80	\$123
<p>Tapered leg with levellers for tables of all depths. Shipped/sold one per carton. Tops sold separately.</p> <ul style="list-style-type: none"> • Available in Silver - SI or Black - BK. Please specify. 						
 <p>Flat Bracket</p>						
	B6PLT	4.5 x 3 x .125	70	2	.10	\$41
<p>To be used as a mending plate for Bungee SL. Black only. Shipped/sold one per pack.</p>						

Required Specifications

Leg Finish

GENERAL INFORMATION

- Power and Data Management Troughs for the **BUNGEE SL** table series. Add Global's proprietary 4-wire power kits and create inexpensive and versatile training, benching, academic and meeting areas.
- Front panels are available in Laminate or Aluminum. A center spine version allows for inexpensive double-sided applications.
- **POWER AND DATA MANAGEMENT TROUGHS** are sold separately and are meant to be used on **BUNGEE SL only**.
- **POWER AND DATA MANAGEMENT TROUGHS** accept Global's 4-wire power kit in addition to numerous data, phone and other multimedia wires.
- Filler modesty panels conceal wiring in spaces not covered by troughs.
- Global laminate and seating products are in compliance with stringent emission guidelines set out by UL/Greenguard Environmental Institute under the standards for low emitting products and materials. www.greenguard.org
- **Level 3 Certified**

FINISHES

Laminate:

ACJ	Absolute Acajou	HGT	Hayden Grey
ASN	Asian Night	QTM	Quartered Mahogany
AWC	Avant Cherry	SOG	Storm Grey
AWH	Avant Honey	TFW	Tiger Fruitwood
BLK	Black	TWL	Tiger Walnut
BRC	Brushed Cobalt	WHE	Walnut Heights
CMB	Clear Maple	WHC	White Chocolate
DES	Dark Espresso	WCR	Winter Cherry
DWT	Designer White	WGY	Willow Grey

Aluminum Face Panel, Trough, Filler Panels and End Caps:

Black - BK Silver - SI

LAMINATE FACE PANEL (LFP)

- Laminate face panel (LFP) on the approach side is 11/16" thick. LFP height is 13".
- Rear access panel is 1/4" thick laminate. Rear panel height is 7.25".
- LFP and rear panel swing up to allow wire access and feature a flexible sweep at the top.
- All laminate components are made of 45 lb. commercial density particle board, covered on both sides with high performance, thermally fused laminate.
- The trough portion of the unit is made of a heavy duty aluminum extrusion to allow wire systems (including Global's 4-Wire System) to lie within the bottom.
- LFP is available in all standard laminates, aluminum trough available in Silver (**SI**) or Black (**BK**) finish, please specify (rear access panel is finished in Brushed Cobalt (**BRC**) laminate when SI is specified, or Black (**BLK**) laminate when BK is specified).
- End Caps (JBEC) sold separately

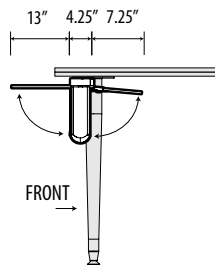

Tops, legs and end caps not included

ALUMINUM FACE PANEL (AFP)

- Aluminum face panel (AFP) is an aluminum extrusion. AFP height is 8.25".
- AFP swings down to allow wire access and features a flexible sweep at the top.
- Rear access panel is 1/4" thick laminate. Rear panel height is 7.25".
- Rear panel swings up to allow wire access and features a flexible sweep at the top.
- The trough portion of the unit is made of a heavy duty aluminum extrusion to allow wire systems (including Global's 4-Wire System) to lie within the bottom.
- AFP and aluminum trough available in Silver (**SI**) or Black (**BK**) finish, please specify (rear access panel is finished in Brushed Cobalt (**BRC**) laminate when SI is specified, or Black (**BLK**) laminate when BK is specified).
- End Caps (JBEC) sold separately.

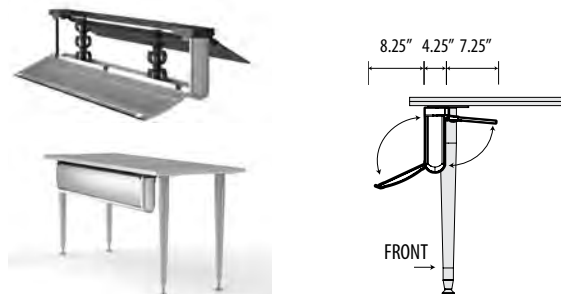

Tops, legs and end caps not included

CENTER SPINE (CS)

- 1/4" thick laminate panels on both sides of the unit. Panel height is 7.25".
- Both panels swing up to allow wire access and feature a flexible sweep at the top.
- All laminate components are made of 45 lb. commercial density particle board, covered on both sides with high performance, thermally fused laminate.
- The trough portion of the unit is made of a heavy duty aluminum extrusion to allow wire systems (like Global's 4-Wire System) to lie within the bottom.
- Aluminum trough available in Silver (**SI**) or Black (**BK**) finish, please specify (rear access panel is finished in Brushed Cobalt (**BRC**) laminate when SI is specified, or both access panels are finished in Black (**BLK**) laminate when BK is specified).
- End Caps (JBEC) sold separately.



Tops, legs and end caps not included

B BUNGEE SL™ POWER/DATA MANAGEMENT TROUGHS - NOTES

FILLER MODESTY PANELS

- Used to fill the space between two power and data management troughs and conceal wiring from the approach side
- Straight Filler allows for use in straight configurations between two rectangular tables with power and data management troughs
- Curved Filler allows for use at curve with 90° wedge tables between two rectangular tables with power and data management troughs
- Available in Silver (SI) or Black (BK) finish. Please specify.



Straight Filler Modesty Panel



Curved Filler Modesty Panel

END CAPS

- Plastic end caps with decorative insert. Required for beginning and end of runs.
- Cap can be notched in field to allow wire infeed pass through.
- Charcoal finish only.



WIRE MANAGEMENT

- Two wire manager clamps are included within all power and data management troughs.
- Attached to the unit, they can slide from side to side to accommodate wiring systems
- Data, voice, multi-media and power can be routed separately using channels on each wire manager.
- Additional wire manager clamps are available to retrofit.
- Available in black only.

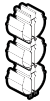

GLOBAL 4-WIRE POWER SYSTEM

- Global's proprietary power system comes with everything you need to power your **BUNGEE SL** layouts. Kits coordinate to the size of the table being used and fit snugly into the bottom of the power and data management trough.
- Single duplex kits come with one duplex – centered on the wiring harness. Duplexes are 6" wide.
- Double duplex kits come with two duplexes – 11" of wiring on each side of the harness allows for flexibility between connections. Duplexes are 6" wide.
- One end of the harness kit features a female connection, while the opposite end features a male connection for a quick and easy connect/disconnect
- Actual kit length is 1" longer than nominal
- Must be hardwired using infeeds (specified separately) by a licensed electrician
- All conduits are enclosed in a black nylon sleeve to reduce visibility
- All duplexes and connectors are plastic. Black only.
- **8 DUPLEXES PER CIRCUIT MAXIMUM** – maximums are to National Electric Code (NEC) – some local codes vary from NEC code – it is the customer's responsibility to follow all applicable local codes and guidelines.

ELECTRICAL SYSTEM

- 4-2 Wiring Schematic
- 4-Wire Shared Neutral
- Complies with National Electric Code
- UL Listed
- All circuits rated for 20 AMP

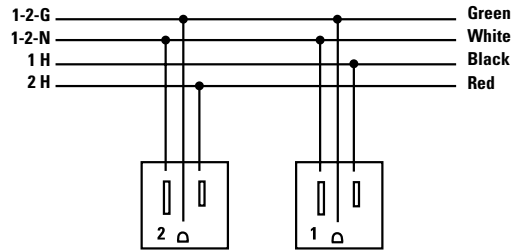

PRODUCT

MAX UNITS PER CIRCUIT

P42S	8 units per circuit
P42D	4 units per circuit

POWER/DATA MANAGEMENT TROUGH PLACEMENT

Single Table - AFP or LFP

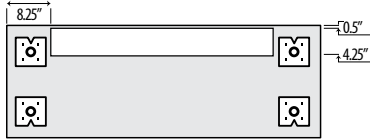

Shared Leg Tables - AFP or LFP

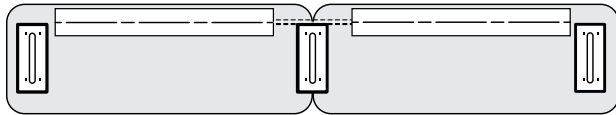
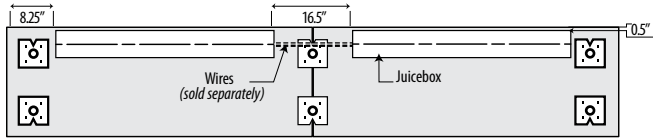

CS

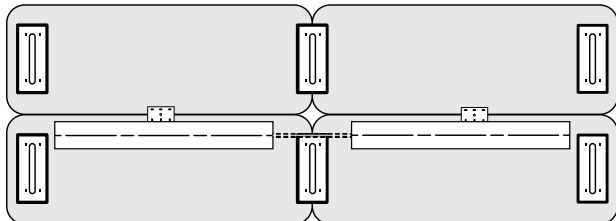
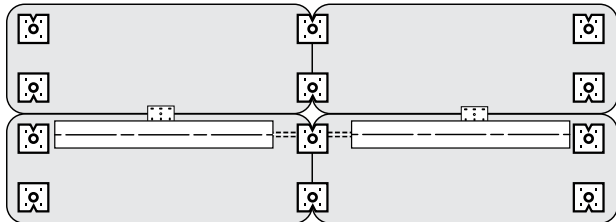
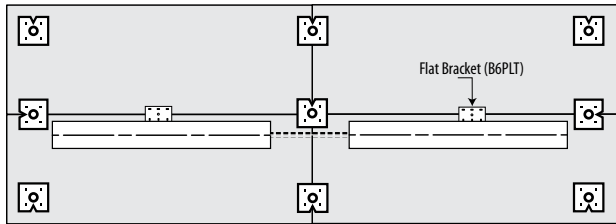

GLOBAL 4-WIRE POWER TO POWER/DATA MANAGEMENT TROUGH:

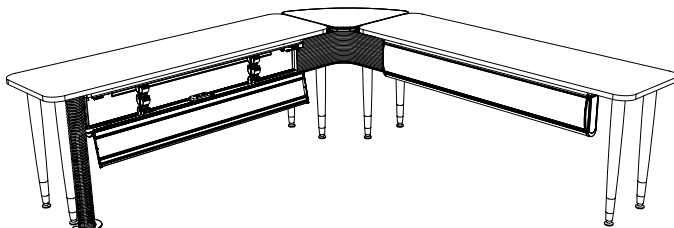

Bungee SL with AFP Power/Data Management Trough - 90° Corner Application

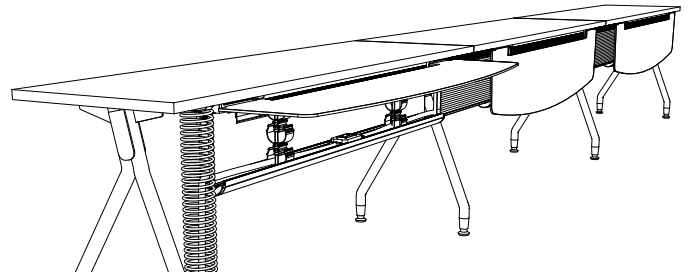

Bungee SL with LFP Power/Data Management Trough - Single Sided Straight Run

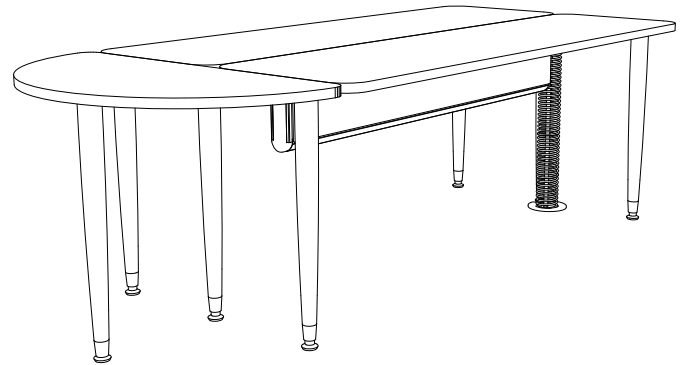

Bungee SL with CS Power/Data Management Trough - Back to Back Application (shown with power snake)

UTILIZING POWER BLOCKS AND GROMMETS WITH POWER/DATA MANAGEMENT TROUGH

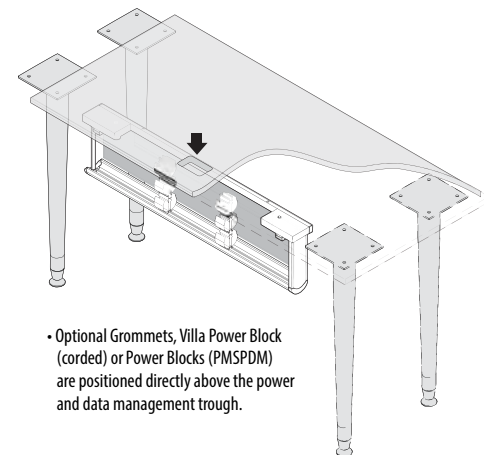

• Optional Grommets, Villa Power Block (corded) or Power Blocks (PMSPDM) are positioned directly above the power and data management trough.

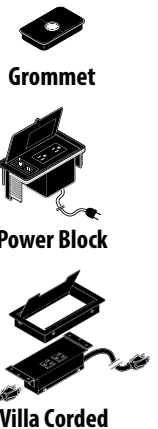

B BUNGEE SL™ POWER/DATA MANAGEMENT TROUGHS

MODEL#	DIMENSIONS	FREIGHT CLASS	WT/LBS.	CUBIC FT.	LIST PRICE
--------	------------	---------------	---------	-----------	------------

D x W x H

JB72L	4.25 x 55.75 x 10	125	23	2.90	\$644
JB60L	4.25 x 43.75 x 10	125	18	2.30	\$576
JB48L	4.25 x 31.75 x 10	100	14	1.70	\$501
JB42L	4.25 x 25.75 x 10	100	12	1.50	\$464
JB36L	4.25 x 19.75 x 10	100	10	1.20	\$425

Trough w/Laminate Face Panel (LFP)

For use on rectangular Bungee SL surfaces only. Out-facing laminate panel swings up to allow wire access and features flexible sweep at the top. In-facing laminate panel swings up to allow wire access and features flexible sweep at the top. Black wire management clamps included.

- To fill the gap between two power/data management trough (LFP) modules in a straight run, a single filler modesty panel (JBFSFM) is recommended.
- To fill the gap between two power/data management trough (LFP) modules at 90°, a corner filler modesty panel (JBCFM) is recommended.
- Model # corresponds to the size table power/data management trough will fit on (i.e. JB72L will fit a 72" wide table).



JB72A	4.25 x 55.75 x 10	100	21	2.20	\$669
JB60A	4.25 x 43.75 x 10	100	17	1.80	\$611
JB48A	4.25 x 31.75 x 10	92.5	13	1.30	\$536
JB42A	4.25 x 25.75 x 10	92.5	11	1.10	\$499
JB36A	4.25 x 19.75 x 10	60	9	.08	\$460

Trough w/Aluminum Face Panel (AFP)

For use on rectangular Bungee SL surfaces only. Out-facing aluminum panel swings down to allow wire access and features flexible sweep at the top. In-facing laminate panel swings up to allow wire access and features flexible sweep at the top. Black wire management clamps included.

- To fill the gap between two power/data management trough (AFP) modules in a straight run, a single filler modesty panel (JBFSFM) is recommended.
- To fill the gap between two power/data management trough (AFP) modules at 90°, a corner filler modesty panel (JBCFM) is recommended.
- Model # corresponds to the size table power/data management trough will fit on (i.e. JB72A will fit a 72" wide table).



JB72C	4.25 x 55.75 x 10	100	19	2.20	\$581
JB60C	4.25 x 43.75 x 10	100	15	1.80	\$547
JB48C	4.25 x 31.75 x 10	100	12	1.30	\$463
JB42C	4.25 x 25.75 x 10	100	10	1.10	\$431
JB36C	4.25 x 19.75 x 10	60	8	.08	\$399

Trough w/Center Spine (CS)

For use on rectangular Bungee SL surfaces only in back-to-back applications only. Two laminate panels swing up to allow wire access and feature flexible sweep at the top. Black wire management clamps included.

- To fill the gap between two power/data management trough (CS) modules in a straight run, two filler modesty panels (JBFSFM) are recommended to conceal wiring from both sides.
- Model # corresponds to the size table power/data management trough will fit on (i.e. JB72C will fit a 72" wide table).

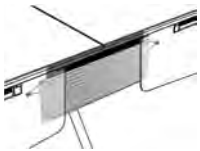

JBFSFM	0.25 x 22.5 x 9	70	1.60	.04	\$140
--------	-----------------	----	------	-----	--------------

Straight Filler Modesty Panel

Straight filler modesty is used to fill the space between two power/data management trough modules where tables are linked in a straight configuration.

- In center spine applications, two straight filler modesty panels should be specified to cover cabling and wires from both sides.
- Filler modesty panels are reversible with Black (BK) finish on one side and Silver (SI) finish on the opposite side.

Required Specifications

Laminate face panel finish (LFP)
Aluminum face panel finish (AFP)
Power/Data Trough finish
Filler Modesty Panel finish.

Optional Specifications

4-Wire Power System



Curved Filler Modesty Panel

MODEL#	DIMENSIONS	FREIGHT CLASS	WT./LBS.	CUBIC FT.	LIST PRICE
--------	------------	---------------	----------	-----------	------------

D x W x H

JBCFM	0.25 x 22.5 x 9	70	1.80	.05	\$166
-------	-----------------	----	------	-----	--------------

Curved filler modesty is used to fill the space between two power/data management troughs where tables are linked at a 90° curve.

- For interior curves only.
- Filler modesty panels are reversible with Black (BK) finish on one side and Silver (SI) finish on the opposite side.



End Cap

JBEC	3 x 8 x 1	70	1	.15	\$33
------	-----------	----	---	-----	-------------

Plastic end cap to be snapped into place at the end of power/data management troughs. To be specified for the beginning and end of runs for a finished look. Charcoal finish only.

- Plastic cap can be notched in the field to allow infeed or data cable pass-through.

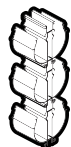

Wire Management Clamp

JBWM2	2.5 x 6 x 1.75	70	1	.01	\$125
-------	----------------	----	---	-----	--------------

Wire management track with double wire clamp - triple height. Can be affixed to the underside of worksurface using double-sided tape (supplied) or retrofit into power/data management trough modules. Black finish only.

- Recommended for use at 90° corners.
- Retrofitting requires disassembly of power/data management trough modules.

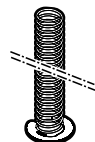

Power Snake

JBPS	4 x 4 x 34	100	2	.25	\$77
------	------------	-----	---	-----	-------------

Attaches to the underside of worksurface with supplied wood screws. Used to organize and channel wires from the power/data management trough down to the floor infeed. Black finish only.

4-WIRE POWER SYSTEM

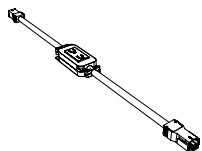

Single Duplex Kit

P42S-72	73 x 2 x 2	60	3.19	.10	\$150
P42S-60	61 x 2 x 2	60	2.82	.09	\$137
P42S-48	49 x 2 x 2	60	2.44	.08	\$126
P42S-42	43 x 2 x 2	60	2.26	.07	\$120
P42S-36	37 x 2 x 2	60	2.07	.06	\$114

Single Duplex Kit includes one black plastic duplex connected to harnesses. Male connection (IN) on one side with female connection (OUT) on the opposite for easy connect and disconnect. Conduit is wrapped in black nylon sleeve. Actual length is 1" longer than nominal.

- Specify Circuit 1 or Circuit 2
- Model # corresponds to the size table power/data management trough will fit on (i.e. P42S-48 will fit a JB48A, JB48L or JB48C module).
- Infeed required for connection to building power. Sold separately (next page)

Required Specifications

Circuit 1 or Circuit 2 (duplex kits)

B BUNGEE SL™ POWER/DATA MANAGEMENT TROUGHS

4-WIRE POWER SYSTEM

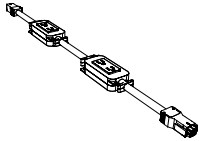

Double Duplex Kit



Power Harness Jumper

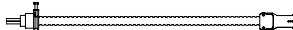

72" Multi-circuit Hardwire Infeed

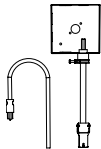

Single-circuit 3-Prong Infeed

MODEL#	DIMENSIONS D x W x H	FREIGHT CLASS	WT./LBS.	CUBIC FT.	LIST PRICE
P42D-72	2 x 73 x 2	60	3.01	.10	\$174
P42D-60	2 x 61 x 2	65	2.63	.09	\$161
P42D-48	2 x 49 x 2	65	2.26	.08	\$149
P42D-42	2 x 43 x 2	65	2.07	.07	\$144
P42D-36	2 x 37 x 2	70	1.88	.06	\$137

Double Duplex Kit includes two black plastic duplexes connected to harnesses. Male connection (IN) on one side with female connection (OUT) on the opposite for easy connect and disconnect. Conduit is wrapped in black nylon sleeve. Actual length is 1" longer than nominal.

- Specify Circuit 1 or Circuit 2. Both duplexes on the kit will be assigned to the same circuit.
- Model # corresponds to the size table power/data management trough will fit on (i.e. P42D-48 will fit a JB48A, JB48L or JB48C module).
- Infeed required for connection to building power. Sold separately (below).

P42J-72	2 x 73 x 2	60	3	.10	\$135
P42J-60	2 x 61 x 2	60	2.73	.09	\$121
P42J-48	2 x 49 x 2	65	2.35	.08	\$107
P42J-42	2 x 43 x 2	60	2.16	.07	\$99
P42J-36	2 x 37 x 2	70	1.98	.06	\$92
P42J-18	2 x 19 x 2	70	1.41	.04	\$71

Male connection (IN) on one side with female connection (OUT) on the opposite for easy connect and disconnect. Conduit is wrapped in black nylon sleeve. Actual length is 1" longer than nominal.

- Use P42J-18 between two power/data management troughs separated by Bungee SL wedge, keystone or half moon tables
- Use all other sizes to jump between power kits on power/data management troughs that are NOT powered (i.e. use a P42J-60 as a pass-through on a 60" wide non-powered table between POWERED power/data management trough modules.

P42HW-72	1 x 72 x 1	70	6.50	.30	\$148
----------	------------	----	------	-----	--------------

72" Multi-circuit Hardwire Infeed (up to 20 AMPS per circuit), two circuits. Provides single power entry from floor or wall located building power supply. Conduit is wrapped in black nylon sleeve.

- Connects P42S or P42D kits
- **TO BE HARDWIRED BY LICENSED ELECTRICIAN.** UL listed.
- Where Liquid Tight conduit is required, specify P42HW-72L

P42TP-120	8 x 4 x 2	70	6.10	.30	\$184
P42TP-72	8 x 4 x 4	60	4.50	.15	\$168

Hardwire junction box included (to be mounted on underside of table). Provides single power entry from floor or wall located building power supply. Conduit is wrapped in black nylon sleeve. Allows for quick and easy disconnection from the wall. Available in 72" or 120" overall lengths.

- Connects P42S or P42D kits. **Power circuit 1 only.**
- **TO BE HARDWIRED BY LICENSED ELECTRICIAN.** UL listed.

Required Specifications

Face panel and box finish - BLK or TUN

POWER BLOCK

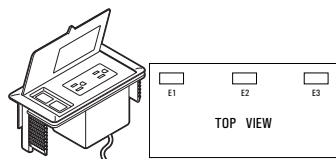

Power/Data Block

MODEL#	DIMENSIONS	FREIGHT CLASS	WT/LBS.	CUBIC FT.	LIST PRICE
	D x W x H				
PMSPDM	3.5 x 6.5 x 2.75	70	2	.10	\$261

Worksurface power and data module. Two power receptacles and two data receptacles. 9' cord. Specify position and **add \$65** for cutout in worksurface. See diagram E1/E2/E3 for specification location. Black (**BLK**) only.

VILLA I SERIES CORDED UNITS

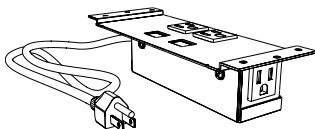

Data Knockouts, No Data Ports

VIL-C-DKO-_-108	3.25 x 8.75 x 2.25	100	4	.45	\$192
VIL-C-DKO-_-72	3.25 x 8.75 x 2.25	100	4	.45	\$192

Villa I with 3-prong plug. Includes **two power receptacles** and two knockouts for data. A third convenience receptacle is provided below the worksurface. **V1, V2 or V3 cutout(s) must be specified on training table** (see product notes section for more details and cutout upcharge). **Grommet cover is required and sold separate** (see below). UL/CUL listed.

- Replace _ with **B** for **Black**
- Replace _ with **S** for **Silver Pearl**

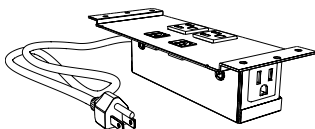

Data Knockouts, Data Ports Included

VIL-C-D-_-108	3.25 x 8.75 x 2.25	100	4	.45	\$311
VIL-C-D-_-72	3.25 x 8.75 x 2.25	100	4	.45	\$311

Villa I with 3-prong plug. Includes **two power receptacles** and **two RJ45 Cat 6** data. A third convenience receptacle is provided below the worksurface. **V1, V2 or V3 cutout(s) must be specified on training table** (see product notes section for more details and cutout upcharge). **Grommet cover is required and sold separate** (see below). UL/CUL listed.

- Replace _ with **B** for **Black**
- Replace _ with **S** for **Silver Pearl**

VILLA GROMMET COVERS

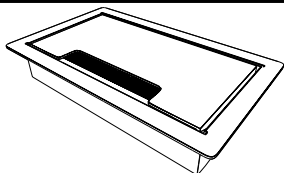

Villa Grommet Cover

VIL-GROM-F-_-	3.5 x 5.75 x .94	70	1	.08	\$96
---------------	------------------	----	---	-----	-------------

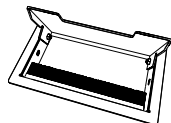

Powder coated flush metal grommet to be used with Villa I **corded** series power blocks. Cutouts in tables must be specified separately. **V1, V2 or V3 cutout(s) must be specified on training table** (see product notes section for more details and cutout upcharge). **Grommet cover remains open while in use.**

- **Cannot be used with PMSPDM.**
- Replace _ with **B** for **Black**
- Replace _ with **S** for **Silver Pearl**

Required Specifications

Face panel and box finish



ConnectTABLES® provides solutions for a variety of day-to-day work environments. Designed as easy-to-use linking or freestanding tables, ConnectTABLES is limited only by your imagination.

Open Conference

Many ConnectTABLES® tops can be assembled to be freestanding. When combined with locking casters and the flip top “T” leg, the result is easy storage and complete portability.

Meeting Rooms

ConnectTABLES® modular units will provide quick and affordable answers for all sizes and shapes of rooms and applications.

Educational and Training Rooms

ConnectTABLES® table tops configure easily into temporary or permanent educational applications.



Features and Benefits

- Optional, easy-to-use thumbscrews allow installation without tools.
- Optional zinc-plated steel ganging hardware connects free standing tops without moving “T” Leg position.
- Optional modesty panel wire management unit available.
- Casters will not affect table height when used in conjunction with or in place of glides.
- Optional Black grommets for convenient wire management can be ordered “factory installed”.
- Tops are 1” thick and constructed of 45 lb. density particleboard.
- Optional casters available with or without manual locks provide mobility.
- ConnectTABLES® tops are available in all Global laminate finishes with three leg and two edge color options.



T Leg with leveling glides



Modesty Panel

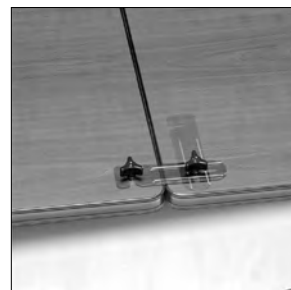

Optional ganging connector

GENERAL INFORMATION

- ConnecTABLES® is an affordable and highly flexible system of modular tables. Designed as easy-to-use linking or freestanding tables, ConnecTABLES adapts to most every requirement: seminar or training room, meeting room, personal workstations, educational, conferencing and team cluster workgroups.
- ConnecTABLES have nine basic top shapes available in various sizes.
- ConnecTABLES edges **do not match** any other Global product in either color or style.
- Global laminate and seating products are in compliance with stringent emission guidelines set out by the Greenguard Environmental Institute under the standards for low emitting products and materials. www.greenguard.org
- **Level 2 Certified**

WORKSURFACES

- Tops are 1" thick, made of 45 lb. density particle board covered on both sides with high performance thermally fused laminate. Optional high pressure laminate tops are 1-1/16" thick.
- Laminate finishes are available in High Pressure. Contact Customer Care for a quote.
- If other than a Global standard laminate finish is preferred, contact Customer Care. Information needed includes the name of the laminate manufacturer, color name, number and model of table. You will then be given a quote for this special order.
- **ConnecTABLES® edges do not match any other Global product in either color or style.**
- Products specified with the high pressure laminate option are finished on the underside of the surface with a kraft paper backing.

CONSTRUCTION

- Some components can stand alone when the "T" base is set in the freestanding position. When the "T" base is in the linking position, all the components can be used in grouping configurations (clusters).
- Optional wire grommets not available on 45° wedge and the 60° triangle.
- Rectangular tops 54" in length and longer are supplied with a 16" gauge steel support channel. Top is pre-drilled for placement.
- Shipped RTA (ready to assemble). Quick and easy to assemble.
- Special width tops are available. Use next size up.
- Tables adjust from 28 3/4" to 29 3/4" high.
- Elliptical column cover, glides, casters, thumbscrews and endcaps available in Black only.
- Must specify top, edge, and "T" base color with each order.

LEGS

- "T" leg is coated with environmentally friendly, recyclable paint electrostatically applied epoxy powder coating for a very durable finish in three colors as specified below. Only the bottom horizontal portion of the painted leg is visible.
- Black plastic leveling glides offer 1" adjustability.
- Two black plastic elliptical column caps cover each leg column.
- Casters will not affect table height when used in conjunction with or in place of glides.
- Casters can facilitate mobility in installations which need to be moved frequently.

LAMINATE FINISHES

ACJ	Absolute Acajou	HGT	Hayden Grey
ASN	Asian Night	QTM	Quartered Mahogany
AWC	Avant Cherry	SOG	Storm Grey
AWH	Avant Honey	TFW	Tiger Fruitwood
BLK	Black	TWL	Tiger Walnut
BRC	Brushed Cobalt	WHE	Walnut Heights
CMB	Clear Maple	WHC	White Chocolate
DES	Dark Espresso	WCR	Winter Cherry
DWT	Designer White	WGY	Willow Grey

EDGE COLORS

Black (BK) Grey (GR)

LEG COLORS

Black (BK) Grey (GR) Chrome (CH)

GROMMETS

- Optional Grommets available in standard worksurface locations (left, center or right) for Rectangular Tables. Order as: **AG1, AG2 or AG3. Add \$69**
- Grommet hole dimensions are 3 1/4" wide x 1 7/8" deep.

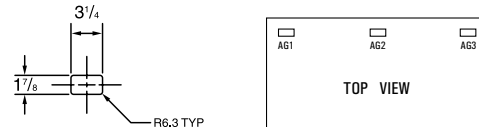

- Grommets may be placed at non-standard locations. Order as: **AGS - Add \$69.** A drawing must be supplied with vertical and horizontal dimensions to the center of the cut-out (as in drawing above). Please refer to CUSTOM GROMMET LOCATION FORM in the back reference section.

POWER BLOCK

- A Power Block (model **PMSPDM**) may be ordered on all worksurfaces.
- A Power Block is a rectangular worksurface power/data module with one electrical duplex receptacle and two data (RJ45) receptacles. 9' black cord included. Power Block dimensions are 3 1/2" deep x 6 1/2" wide x 2 3/4" high.
- To purchase a Power Block, you must specify both the Power Block cut-out location and the Power Block model #. Order Power Block as **PMSPDM, ADD \$261.** Power Blocks are available in standard worksurface locations (left, center or right). Order as **E1, E2 or E3. Add \$69.**



Power Block **PMSPDM, Add \$261** Specify location **E1, E2 or E3, Add \$69.**

EXAMPLES OF GROMMET AND POWER BLOCK POSITIONS

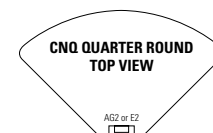
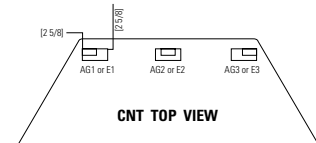
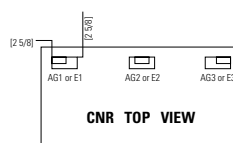

C CONNECTABLES® - NOTES

VILLA CUTOUTS

- Optional Villa cutout available in standard worksurface locations (left, center or right) for **Rectangular Tables**. Order as: **V1, V2 or V3** - Add \$69 for each cutout.
- Villa cutouts may be placed at non-standard locations. Please contact customer care.

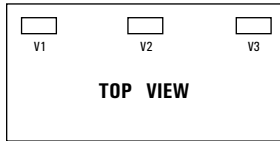

TOP & EDGE OPTIONS

- ConnectTABLES® have nine basic top shapes available in various sizes. All top shapes have a variety of straight or curved edges which are referred to as **Working (W)**, **Connecting (C) or End (E) edges**. Edges can also have a combination of edge types as shown.

*cannot freestand

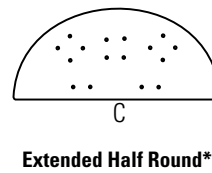
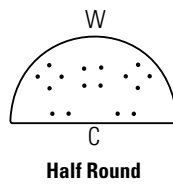
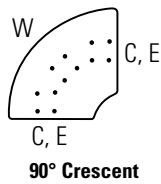
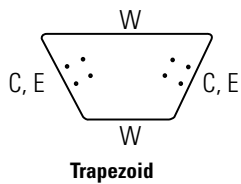
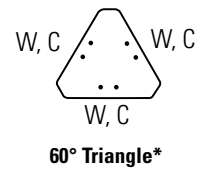
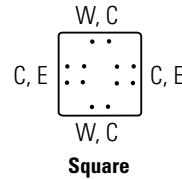
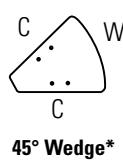
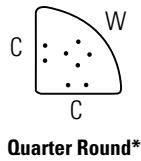
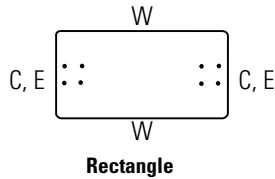

Working Edge (1) - Edges designated with the letter "W" indicate that this is a **working** or sitting edge. These edges can be connected with optional ganging hardware in free-standing applications.

Connecting Edge (2) - Edges designated with the letter "C" indicate that this is a **connecting** edge. These edges can be connected to any other connecting edge of equal width, regardless of the top shape or size.

End Edge (3) - Edges designated with the letter "E" indicate that this is an **end** edge or an edge that can finish a run of tops. If a top has two end edges it can be freestanding. 90° crescent tops can be freestanding if the optional center leg is added.

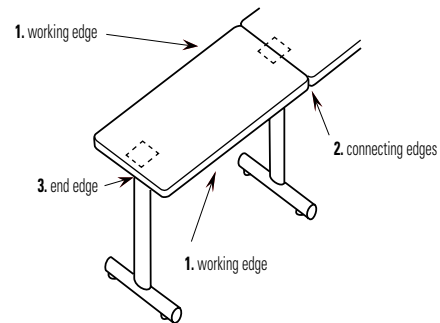

FREESTANDING AND CONNECTING CONDITIONS

Freestanding tables are defined as any one worksurface supported by two or more legs; **connecting tables** are defined as more than one work surface supported by a single leg at each point of connection. The rule for determining the quantity of legs of an open configuration is the number of worksurfaces plus one (**See Figure 1**).

On closed configurations, the number of legs is equal to the number of worksurfaces (**See Figure 2**). There are some exceptions, such as when optional third legs are used on quarter round or 90° crescent shapes.

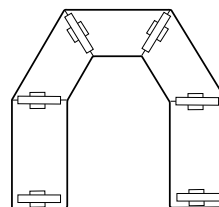

Figure 1. Open Configuration
Number of Surfaces = 5
Number of Legs = 6

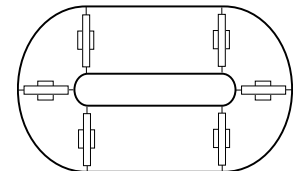

Figure 2. Closed Configuration
Number of Surfaces = 6
Number of Legs = 6

FREESTANDING CONDITIONS

- All square, rectangle and trapezoid shapes are able to act as freestanding tables (**Figure 3**).
- When Trapezoid tops are freestanding, legs must be on the outer left and right sides (**Figure 4**).
- 90° crescent work surfaces have provision for an optional third center leg for additional stability when heavy loads are applied to the outside edge. They can also be used as freestanding tables when a third leg is added (**Figure 5**).
- All freestanding tables can be connected with optional ganging hardware.
- Freestanding tables can be ganged with connected tables in some cases, providing that the number and size of connected tables is easily movable (**Figure 6**).
- **DO NOT DRAG TABLES WHEN RE-CONFIGURING.**

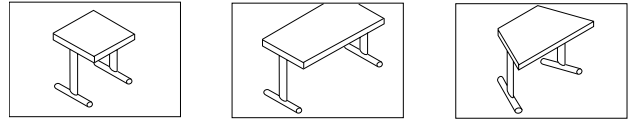

Figure 3 - Freestanding Tables

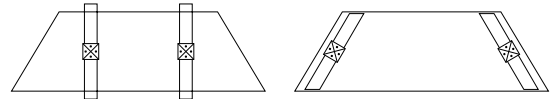

Figure 4 - Trapezoid Tops

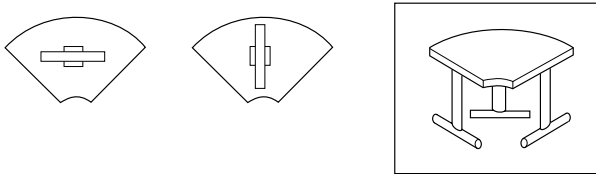

Figure 5 - Adding a Third Leg

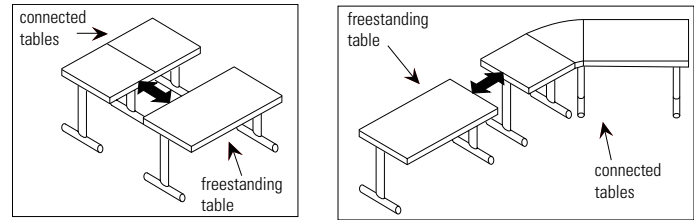

Figure 6 - Ganging with Connected Tables

CONNECTING CONDITIONS

- Any two worksurfaces of equal depth (24"D, 30"D or 36"D) can be connected with one leg, at the connecting or end edges (**Figure 8**).
- Half round work surfaces can be used in the following ways: They must be of equal width when connected to each other (**Figure 7**) or the connecting shapes must be equal to half the width of the connecting half round (**Figure 8**).
- ConnectABLES® is designed with the leg to be fastened parallel to connecting edges, but in some cases you may wish to fasten legs at 90° to connecting edges. This could allow for increased leg or knee clearance, depending on the intended use (**Figure 9**).
- Quarter round and 90° crescent work surfaces have provision for an optional third leg for additional stability when heavy loads are applied to the outside edge. For quarter round work surfaces, it is recommended that configuration "A" be used since the outside end of the center leg in configuration "B" is almost flush with the outside edge of the worksurface. If configuration "B" is installed against a wall or where there will be no traffic flow, then configuration "B" can be used.

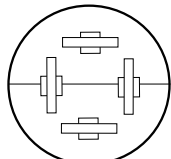

Figure 7

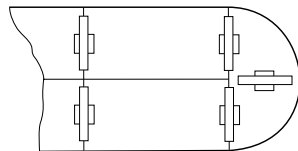

Figure 8

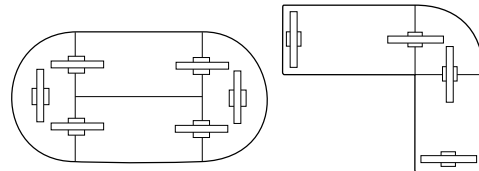
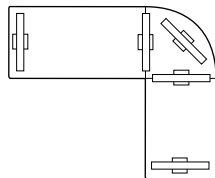
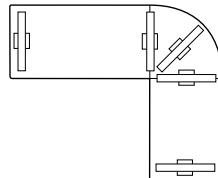

Figure 9 - 90° Leg Connections



Configuration A



Configuration B

C CONNECTABLES® - PUTTING IT ALL TOGETHER

Legs are fastened to work surfaces utilizing a steel-to-steel connection. Each leg comes equipped with four ¼" x 7/8" machine screws. Screws are inserted through the four oval shaped holes only. Do not use wood screws! When fastening legs to work surfaces, hand thread screws into position to prevent any cross threading. When all screws have been hand threaded, tighten firmly with screwdriver to secure. Optional thumbscrews can be used in place of machine screws. Thumbscrews eliminate the need for a screwdriver, whether assembling or disassembling tables. **Do not use power tools for assembly of legs.**

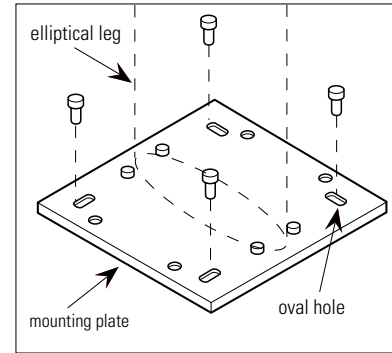

FREESTANDING TABLES

1. Turn work surface upside-down on clean floor. (You may want to use carton from packaging as a protective assembly surface to protect the top from scratching.)
2. Position leg mounting plate holes over threaded steel inserts in top.
3. Fasten each leg to top with four ¼" x 7/8" screws.
4. Turn table right-side up.
5. Level table by adjusting glides.

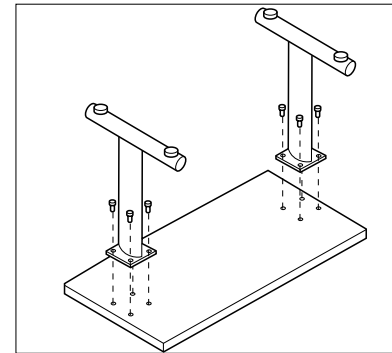

CONNECTING TABLES

1. Determine approximate location of desired configuration in room and turn work surfaces upside-down on floor. (Remember you are working in reverse.)
2. Position leg mounting plate so it is centered over the connecting edge of the first work surface. Fasten leg with two ¼" x 7/8" screws.
3. Repeat step 2 and 3 on the opposite edge of the first work surface.
4. Turn table right-side up.
5. Turn table right-side up and fasten to the previous top from the underside.
6. To add additional work surfaces repeat step 6.
7. When all the tops have been connected, level complete configuration by adjusting glides.

Note: Use the same procedures as above when using optional thumb screws.

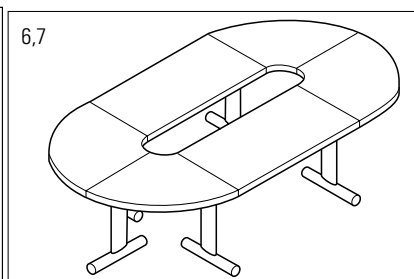
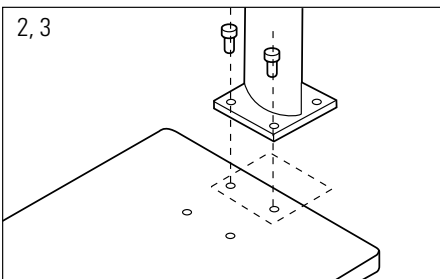
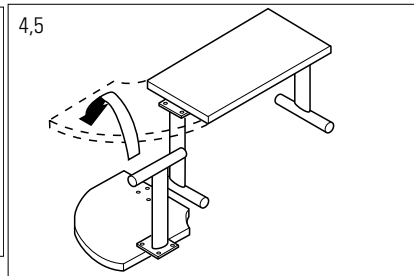
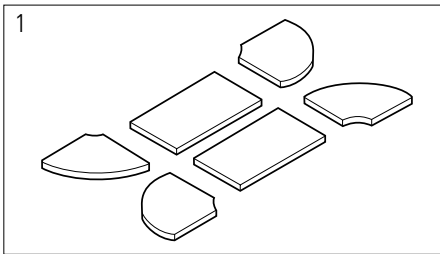

OPTIONAL CASTERS

1. Turn work surface upside-down on floor.
2. Remove existing glide if previously installed.
3. Fasten caster to T-leg by threading caster stem into base of T-leg and secure by tightening lock nut.
4. If casters are used in combination with gliders, level table by adjusting glides.

Note: Casters are available in locking or non-locking styles.

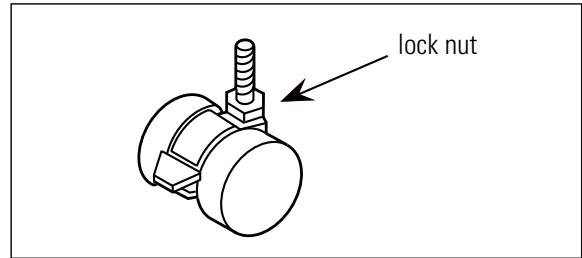
**OPTIONAL GANGING HARDWARE**

1. Optional ganging hardware should be used when quick and frequent reconfigurations are required.
2. Turn work surfaces to be ganged upside-down on floor.
3. Remove ganging hardware from package. Holes with steel inserts are located in the corner of tops.
4. Fasten ganging hardware to each work surface with supplied thumb screws.
5. Projected arm from ganging hardware can pivot out of the way when not in use.

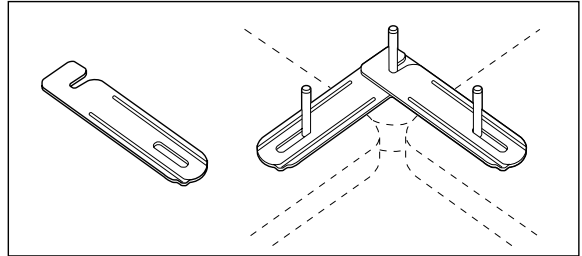

SQUARE TOPS

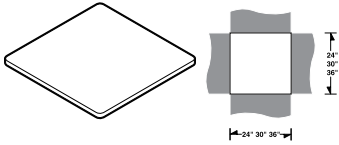

Square Top

MODEL#	DIMENSIONS D x W x H	FREIGHT CLASS	WT./LBS.	CUBIC FT.	LIST PRICE	HP ADD
CNS2424	24 x 24 x 1.12	70	18	1	\$314	\$157
CNS3030	30 x 30 x 1.12	70	27	1.56	\$383	\$191.50
CNS3636	36 x 36 x 1.12	70	39	2	\$411	\$205.50

T-mold edging. Predrilled with threaded steel inserts for freestanding and linking installations.

RECTANGULAR TOPS

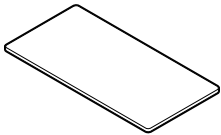
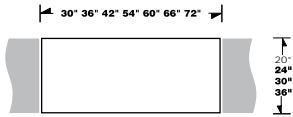

Rectangle Top

MODEL #	DIMENSIONS	FREIGHT CLASS	WT./LB.	CUBIC FT.	LIST PRICE	HP ADD
CNR2030	20 x 30 x 1.13	70	22	1.25	\$226	\$113
CNR2036	20 x 36 x 1.13	60	22.50	.46	\$252	\$126
CNR2042	20 x 42 x 1.13	70	31	1.75	\$271	\$135.50
CNR2048	20 x 48 x 1.13	70	35	2	\$302	\$151
CNRU2054	20 x 54 x 1.13	60	33.75	.69	\$375	\$187.50
CNRU2060	20 x 60 x 1.13	70	37.50	1.40	\$403	\$201.50
CNRU2066	20 x 66 x 1.13	70	41.25	.84	\$436	\$218
CNRU2072	20 x 72 x 1.13	70	45	1	\$465	\$232.50
CNR2430	24 x 30 x 1.12	70	22	1.25	\$226	\$113
CNR2436	24 x 36 x 1.12	70	26	1.50	\$252	\$126
CNR2442	24 x 42 x 1.12	70	31	1.75	\$271	\$135.50
CNR2448	24 x 48 x 1.12	70	35	2	\$302	\$151
CNRU2454	24 x 54 x 1.12	70	42	2.34	\$375	\$187.50
CNRU2460	24 x 60 x 1.12	70	47	2.50	\$403	\$201.50
CNRU2466	24 x 66 x 1.12	70	52	2.80	\$436	\$218
CNRU2472	24 x 72 x 1.12	70	57	3	\$465	\$232.50
CNR3036	30 x 36 x 1.12	70	33	1.88	\$302	\$151
CNR3042	30 x 42 x 1.12	70	38	2.19	\$328	\$164
CNR3048	30 x 48 x 1.13	70	44	2.50	\$348	\$174
CNRU3054	30 x 54 x 1.12	70	52	2.80	\$431	\$215.50
CNRU3060	30 x 60 x 1.12	70	59	3.13	\$463	\$231.50
CNRU3066	30 x 66 x 1.12	70	64	3.44	\$494	\$247
CNRU3072	30 x 72 x 1.12	70	70	3.75	\$527	\$263.50
CNR3642	36 x 42 x 1.12	60	52.50	1.60	\$436	\$218
CNR3648	36 x 48 x 1.12	60	60	1.80	\$476	\$238
CNRU3654	36 x 54 x 1.12	60	70	2	\$576	\$288
CNRU3660	36 x 60 x 1.12	60	78	2.20	\$640	\$320
CNRU3666	36 x 66 x 1.12	60	87	2.40	\$700	\$350
CNRU3672	36 x 72 x 1.12	60	94	2.60	\$763	\$381.50

T-mold edging. Predrilled with threaded steel inserts for freestanding and linking installations. **Tops 54" and longer are standard with a 16 gauge steel support channel.**

TRAPEZOID TOPS

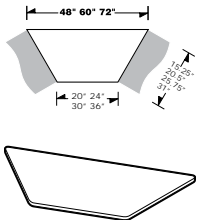

Trapezoid Top

MODEL #	DIMENSIONS	FREIGHT CLASS	WT./LB.	CUBIC FT.	LIST PRICE	HP ADD
CNT2048	15.25 x 48 x 1.13	65	26.25	.55	\$317	\$158.50
CNT2060	15.25 x 60 x 1.13	65	44	1.85	\$381	\$190.50
CNT2448	20.5 x 48 x 1.12	92.5	21	2	\$317	\$158.50
CNT2460	20.5 x 60 x 1.12	65	44	1.85	\$381	\$190.50
CNT3060	25.75 x 60 x 1.12	92.5	35	3.13	\$417	\$208.50
CNT3072	25.75 x 72 x 1.12	60	66	2.20	\$465	\$232.50
CNT3660	31 x 60 x 1.12	60	66	2.20	\$595	\$297.50
CNT3672	31 x 72 x 1.12	65	79.20	3.50	\$710	\$355

T-mold edging. Predrilled with threaded steel inserts for freestanding and linking installations.

Required Specifications

Top Finish
Edge Finish

Optional Specifications

Grommet

Accessories

Power Block

90° CRESCENT TOPS

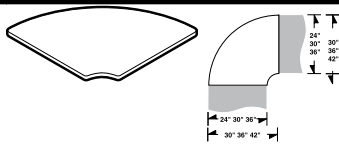

90° Crescent Top

MODEL#	DIMENSIONS	FREIGHT CLASS	WT/LBS.	CUBIC FT.	LIST PRICE	HP ADD
D x W x H						
CNC2430	30 x 30 x 1.12	85	20	1.56	\$332	\$166
CNC3036	36 x 36 x 1.12	85	30	2.25	\$472	\$236
CNC3642	42 x 42 x 1.12	70	50	3.15	\$647	\$323.50

T-mold edging. Predrilled with threaded steel inserts for freestanding and linking installations.

- **CNC2430** for use with 24" deep tops
- **CNC3036** for use with 30" deep tops
- **CNC3642** for use with 36" deep tops
- **CNC2430** does not require a center leg

QUARTER ROUND TOPS

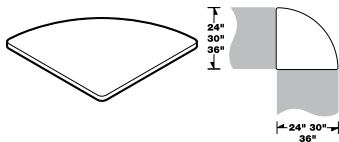

Quarter Round Top

MODEL #	DIMENSIONS	FREIGHT CLASS	WT/LB.	CUBIC FT.	LIST PRICE	HP ADD
CNQ2424	24 x 24 x 1.12	85	14	1	\$209	\$104.50
CNQ3030	30 x 30 x 1.12	85	21	1.56	\$253	\$126.50
CNQ3636	36 x 36 x 1.12	60	45	1.30	\$359	\$179.50

T-mold edging. Predrilled with threaded steel inserts for **linking installations ONLY**.

45° WEDGE TOPS

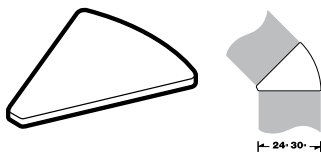

45° Wedge Top

MODEL #	DIMENSIONS	FREIGHT CLASS	WT/LB.	CUBIC FT.	LIST PRICE	HP ADD
CNW2424	24 x 24 x 1.12	92.5	10	1	\$223	\$111.50
CNW3030	30 x 30 x 1.12	100	14	1.56	\$272	\$136

T-mold edging. Predrilled with threaded steel inserts for **linking installations ONLY**.

THREE WAY CONNECTOR TOPS

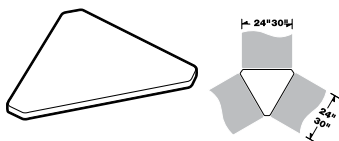

Three Way Connector Top

MODEL #	DIMENSIONS	FREIGHT CLASS	WT/LB.	CUBIC FT.	LIST PRICE	HP ADD
CNY2424	24 x 24 x 1.12	85	13	1	\$209	\$104.50
CNY3030	30 x 30 x 1.12	92.5	18	1.56	\$253	\$126.50

T-mold edging. Predrilled with threaded steel inserts for **linking installations ONLY**.

HALF ROUND TOPS

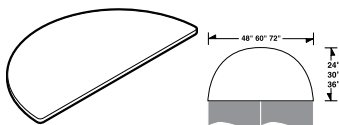

Half Round Top

MODEL #	DIMENSIONS	FREIGHT CLASS	WT/LB.	CUBIC FT.	LIST PRICE	HP ADD
CNHFS2448	24 x 48 x 1.12	70	36	2	\$320	\$160
CNHFS3060	30 x 60 x 1.12	70	56	3.13	\$415	\$207.50
CNHFS3672	36 x 72 x 1.12	65	81	3.30	\$710	\$355

T-mold edging. Predrilled with threaded steel inserts for freestanding and linking installations.

- *Requires three legs for freestanding*

EXTENDED HALF ROUND TOPS

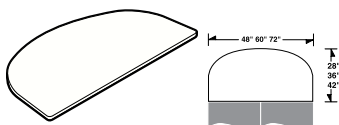

Extended Half Round Top

MODEL #	DIMENSIONS	FREIGHT CLASS	WT/LB.	CUBIC FT.	LIST PRICE	HP ADD
CNHE24	28 x 48 x 1.13	65	50	1.88	\$391	\$195.50
CNHE30	36 x 60 x 1.13	65	75	2.87	\$545	\$272.50
CNHE36	42 x 72 x 1.13	65	102	3.88	\$867	\$433.50

T-mold edging. Predrilled with threaded steel inserts for **linking installations ONLY**.

Required Specifications

Top Finish
Edge Finish

Optional Specifications

Grommet

Accessories

Power Block

MODESTY PANELS



Modesty Panel

MODEL#	DIMENSIONS D x W x H	FREIGHT CLASS	WT./LBS.	CUBIC FT.	LIST PRICE
CNCA2430	2.75 x 35 x 11.75	150	2.80	.50	\$185
CNCA3036	2.75 x 43 x 11.75	150	3.30	.60	\$217
CNCA3642	2.75 x 53 x 11.75	150	3.90	.70	\$284

For use with **CNC crescent tops**. 11 3/4" high, Black plastic, attractive ribbed design. Includes two fold-away installation clips and flexible privacy strips. Connects to predrilled holes in table top.

- *Can not be used when worksurface tops are attached to flip top legs.*

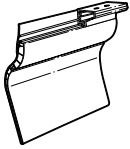

Modesty Panel

CNOA2424	2.75 x 27 x 11.75	150	2.20	.40	\$158
CNOA3030	2.75 x 35 x 11.75	150	2.80	.50	\$185
CNOA3636	2.75 x 44 x 11.75	150	3.30	.60	\$217

For use with **CNQ quarter round tops**. 11 3/4" high, Black plastic, attractive ribbed design. Includes two fold-away installation clips and flexible privacy strips. Connects to predrilled holes in table top.

- *Can not be used when worksurface tops are attached to flip top legs.*

CNRA2030	2.75 x 29 x 11.75	150	2.80	.50	\$158
CNRA2036	2.75 x 35 x 11.75	150	3.30	.60	\$185
CNRA2042	2.75 x 41 x 11.75	150	3.90	.70	\$217
CNRA2048	2.75 x 47 x 11.75	150	4.40	.80	\$246
CNRA2054	2.75 x 53 x 11.75	150	5	.90	\$284
CNRA2060	2.75 x 59 x 11.75	150	5.50	1	\$307
CNRA2066	2.75 x 65 x 11.75	150	6.10	1.10	\$337
CNRA2072	2.75 x 71 x 11.75	150	6.60	1.20	\$368

CNRA2430	2.75 x 29 x 11.75	150	2.80	.50	\$158
CNRA2436	2.75 x 35 x 11.75	150	3.30	.60	\$185
CNRA2442	2.75 x 41 x 11.75	150	3.90	.70	\$217
CNRA2448	2.75 x 47 x 11.75	150	4.40	.80	\$246
CNRA2454	2.75 x 53 x 11.75	150	5	.90	\$284
CNRA2460	2.75 x 59 x 11.75	150	5.50	1	\$307
CNRA2466	2.75 x 65 x 11.75	150	6.10	1.10	\$337
CNRA2472	2.75 x 71 x 11.75	150	6.60	1.20	\$368

CNRA3036	2.75 x 35 x 11.75	150	3.30	.60	\$185
CNRA3042	2.75 x 41 x 11.75	150	3.90	.70	\$217
CNRA3048	2.75 x 47 x 11.75	150	4.40	.80	\$246
CNRA3054	2.75 x 53 x 11.75	150	5	.90	\$284
CNRA3060	2.75 x 59 x 11.75	150	5.50	1	\$307
CNRA3066	2.75 x 65 x 11.75	150	6.10	1.10	\$337
CNRA3072	2.75 x 71 x 11.75	150	6.60	1.20	\$368

CNRA3642	2.75 x 41 x 11.75	150	3.90	.70	\$217
CNRA3648	2.75 x 47 x 11.75	150	4.40	.80	\$246
CNRA3654	2.75 x 53 x 11.75	150	5	.90	\$284
CNRA3660	2.75 x 59 x 11.75	150	5.50	1	\$307
CNRA3666	2.75 x 65 x 11.75	150	6.10	1.10	\$337
CNRA3672	2.75 x 71 x 11.75	150	6.60	1.20	\$368

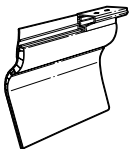

Modesty Panel

For use with **CNR/CNRU rectangular tops**. 11 3/4" high, Black plastic, attractive ribbed design. Includes two fold-away installation clips and flexible privacy strips. Connects to predrilled holes in table top.

- *Can not be used when worksurface tops are attached to flip top legs.*

Required Specifications

Top Finish
Edge Finish

Optional Specifications

Grommet

Accessories

Power Block

MODESTY PANELS

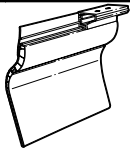

Modesty Panel

MODEL# DIMENSIONS FREIGHT CLASS WT/LBS. CUBIC FT. LIST PRICE

D x W x H

CNSA2424	2.75 x 23 x 11.75	150	2.20	.40	\$126
CNSA3030	2.75 x 29 x 11.75	150	2.80	.50	\$158
CNSA3636	2.75 x 35 x 11.75	150	3.30	.60	\$185

For use with **long side of CNS square tops**. 11 3/4" high, Black plastic, attractive ribbed design. Includes two fold-away installation clips and flexible privacy strips. Connects to predrilled holes in table top.

- *Can not be used when worksurface tops are attached to flip top legs.*

CNTA2048L	2.75 x 43 x 11.75	150	4.40	.80	\$217
CNTA2060L	2.75 x 55 x 11.75	150	5.50	1.20	\$284

CNTA2448L	2.75 x 43 x 11.75	150	4.40	.80	\$217
CNTA2460L	2.75 x 55 x 11.75	150	5.50	1.20	\$284

CNTA3060L	2.75 x 55 x 11.75	150	5.50	1.20	\$284
CNTA3072L	2.75 x 67 x 11.75	150	6.60	1.40	\$337

CNTA3660L	2.75 x 55 x 11.75	150	5.50	1.20	\$284
CNTA3672L	2.75 x 67 x 11.75	150	6.60	1.40	\$337

For use with **long side of CNT trapezoid tops**. 11 3/4" high, Black plastic, attractive ribbed design. Includes two fold-away installation clips and flexible privacy strips. Connects to predrilled holes in table top.

- *Can not be used when worksurface tops are attached to flip top legs.*

CNTA2048S	2.75 x 24 x 11.75	150	2.20	.40	\$126
CNTA2060S	2.75 x 36 x 11.75	150	2.80	.50	\$185

CNTA2448S	2.75 x 23 x 11.75	150	2.20	.40	\$126
CNTA2460S	2.75 x 35 x 11.75	150	2.20	.40	\$185

CNTA3060S	2.75 x 29 x 11.75	150	2.80	.50	\$158
CNTA3072S	2.75 x 41 x 11.75	150	2.80	.50	\$217

CNTA3660S	2.75 x 23 x 11.75	150	3.30	.60	\$126
CNTA3672S	2.75 x 35 x 11.75	150	3.30	.60	\$185

For use with **short side of CNT trapezoid tops**. 11 3/4" high, Black plastic, attractive ribbed design. Includes two fold-away installation clips and flexible privacy strips. Connects to predrilled holes in table top.

- *Can not be used when worksurface tops are attached to flip top legs.*

CNWA2424	2.75 x 17 x 11.75	150	2.20	.40	\$97
CNWA3030	2.75 x 22 x 11.75	150	2.80	.50	\$126

For use with **CNW wedge tops**. 11 3/4" high, Black plastic, attractive ribbed design. Includes two fold-away installation clips and flexible privacy strips. Connects to predrilled holes in table top.

- *Can not be used when worksurface tops are attached to flip top legs.*

CNYA2424	2.75 x 22 x 11.75	150	2.20	.40	\$118
CNYA3030	2.75 x 27 x 11.75	150	2.80	.50	\$145

For use with **CNY triangle tops**. 11 3/4" high, Black plastic, attractive ribbed design. Includes two fold-away installation clips and flexible privacy strips. Connects to predrilled holes in table top.

- *Can not be used when worksurface tops are attached to flip top legs.*

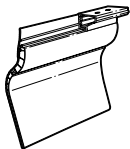

Modesty Panel

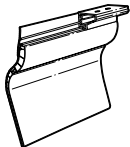

Modesty Panel

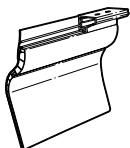

Modesty Panel

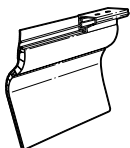

Modesty Panel

Required Specifications

Top Finish
Edge Finish

Optional Specifications

Grommet

Accessories

Power Block

WIRE MANAGEMENT UNITS

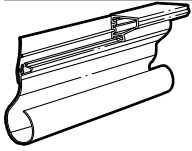

Wire Management Unit

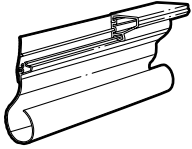

Wire Management Unit

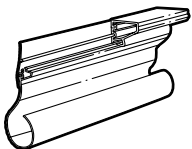

Wire Management Unit

MODEL#	DIMENSIONS D x W x H	FREIGHT CLASS	WT./LBS.	CUBIC FT.	LIST PRICE
CNCB2430	2.75 x 35 x 6	70	1.50	.50	\$139
CNCB3036	2.75 x 43 x 6	70	1.80	.60	\$156
CNCB3642	2.75 x 53 x 6	250	2.10	.70	\$203

For use with **CNC crescent tops**. 6" high, Black plastic, attractive ribbed design. Includes two fold-away installation clips and flexible privacy strips. Connects to predrilled holes in table top. Can be used with or without wire management grommet.

- *Can not be used when worksurface tops are attached to flip top legs.*

CNQB2424	2.75 x 27 x 6	70	1.20	.40	\$117
CNQB3030	2.75 x 35 x 6	70	1.50	.50	\$139
CNQB3636	2.75 x 44 x 6	70	1.80	.60	\$181

For use with **CNQ quarter round tops**. 6" high, Black plastic, attractive ribbed design. Includes two fold-away installation clips and flexible privacy strips. Connects to predrilled holes in table top. Can be used with or without wire management grommet.

- *Can not be used when worksurface tops are attached to flip top legs.*

CNRB2030	2.75 x 29 x 6	70	1.50	.50	\$117
CNRB2036	2.75 x 35 x 6	70	1.80	.60	\$139
CNRB2042	2.75 x 41 x 6	250	2.10	.70	\$156
CNRB2048	2.75 x 47 x 6	250	2.40	.80	\$217
CNRB2054	2.75 x 53 x 6	250	2.70	.90	\$226
CNRB2060	2.75 x 59 x 6	250	3	1	\$226
CNRB2066	2.75 x 65 x 6	250	3.30	1.10	\$226
CNRB2072	2.75 x 71 x 6	250	3.60	1.20	\$307

CNRB2430	2.75 x 29 x 6	70	1.50	.50	\$117
CNRB2436	2.75 x 35 x 6	70	1.80	.60	\$139
CNRB2442	2.75 x 41 x 6	250	2.10	.70	\$156
CNRB2448	2.75 x 47 x 6	250	2.40	.80	\$217
CNRB2454	2.75 x 53 x 6	250	2.70	.90	\$226
CNRB2460	2.75 x 59 x 6	250	3	1	\$226
CNRB2466	2.75 x 65 x 6	250	3.30	1.10	\$226
CNRB2472	2.75 x 71 x 6	250	3.60	1.20	\$307

CNRB3036	2.75 x 35 x 6	70	1.80	.60	\$139
CNRB3042	2.75 x 41 x 6	250	2.10	.70	\$156
CNRB3048	2.75 x 47 x 6	250	2.40	.80	\$181
CNRB3054	2.75 x 53 x 6	250	2.70	.90	\$203
CNRB3060	2.75 x 59 x 6	250	3	1	\$226
CNRB3066	2.75 x 65 x 6	250	3.30	1.10	\$268
CNRB3072	2.75 x 71 x 6	250	3.60	1.20	\$307

CNRB3642	2.75 x 41 x 6	250	2.10	.70	\$156
CNRB3648	2.75 x 47 x 6	250	2.40	.80	\$203
CNRB3654	2.75 x 53 x 6	250	2.70	.90	\$203
CNRB3660	2.75 x 59 x 6	250	3	1	\$226
CNRB3666	2.75 x 65 x 6	250	3.30	1.10	\$226
CNRB3672	2.75 x 71 x 6	250	3.60	1.20	\$307

For use with **CNR/CNRU rectangular tops**. 6" high, Black plastic, attractive ribbed design. Includes two fold-away installation clips and flexible privacy strips. Connects to predrilled holes in table top. Can be used with or without wire management grommet.

- *Can not be used when worksurface tops are attached to flip top legs.*

Required Specifications

Top Finish
Edge Finish

Optional Specifications

Grommet

Accessories

Power Block

WIRE MANAGEMENT UNITS

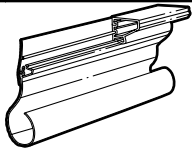

Wire Management Unit

MODEL# DIMENSIONS FREIGHT CLASS WT/LBS. CUBIC FT. LIST PRICE

	D x W x H				
CNSB2424	2.75 x 23 x 6	70	1.80	.40	\$93
CNSB3030	2.75 x 29 x 6	70	1.50	.50	\$117
CNSB3636	2.75 x 35 x 6	70	1.80	.60	\$139

For use with **CNS square tops**. 6" high, Black plastic, attractive ribbed design. Includes two fold-away installation clips and flexible privacy strips. Connects to predrilled holes in table top. Can be used with or without wire management grommet.

- *Can not be used when worksurface tops are attached to flip top legs.*

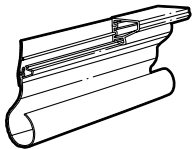

Wire Management Unit

CNTB2048L	2.75 x 43 x 6	250	2.40	.80	\$156
CNTB2060L	2.75 x 55 x 6	250	3	1	\$203
CNTB2448L	2.75 x 43 x 6	250	2.40	.80	\$156
CNTB2460L	2.75 x 55 x 6	250	3	1	\$203
CNTB3060L	2.75 x 55 x 6	250	3	1	\$203
CNTB3072L	2.75 x 67 x 6	250	3.60	1.20	\$284
CNTB3660L	2.75 x 55 x 6	250	3	1	\$203
CNTB3672L	2.75 x 67 x 6	250	3.60	1.20	\$284

For use with **long side of CNT trapezoid tops**. 6" high, Black plastic, attractive ribbed design. Includes two fold-away installation clips and flexible privacy strips. Connects to predrilled holes in table top. Can be used with or without wire management grommet.

- *Can not be used when worksurface tops are attached to flip top legs.*

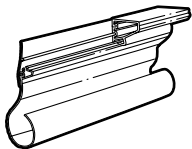

Wire Management Unit

CNTB2048S	2.75 x 23 x 6	70	1.20	.40	\$93
CNTB2060S	2.75 x 35 x 6	70	1.50	.50	\$139
CNTB2448S	2.75 x 23 x 6	70	1.20	.40	\$93
CNTB2460S	2.75 x 35 x 6	70	1.20	.40	\$139
CNTB3060S	2.75 x 29 x 6	70	1.50	.50	\$117
CNTB3072S	2.75 x 41 x 6	70	1.50	.50	\$156
CNTB3660S	2.75 x 23 x 6	70	1.80	.60	\$93
CNTB3672S	2.75 x 35 x 6	70	1.80	.60	\$139

For use with **short side of CNT trapezoid tops**. 6" high, Black plastic, attractive ribbed design. Includes two fold-away installation clips and flexible privacy strips. Connects to predrilled holes in table top. Can be used with or without wire management grommet.

- *Can not be used when worksurface tops are attached to flip top legs.*

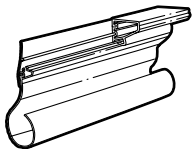

Wire Management Unit

CNWB2424	2.75 x 17 x 6	70	1.20	.40	\$76
CNWB3030	2.75 x 22 x 6	70	1.50	.50	\$93

For use with **CNW wedge tops**. 6" high, Black plastic, attractive ribbed design. Includes two fold-away installation clips and flexible privacy strips. Connects to predrilled holes in table top. Can be used with or without wire management grommet.

- *Can not be used when worksurface tops are attached to flip top legs.*

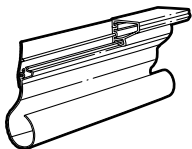

Wire Management Unit

CNYB2424	2.75 x 22 x 6	70	1.20	.40	\$93
CNYB3030	2.75 x 27 x 6	70	1.50	.50	\$117

For use with **CNY triangle tops**. 6" high, Black plastic, attractive ribbed design. Includes two fold-away installation clips and flexible privacy strips. Connects to predrilled holes in table top. Can be used with or without wire management grommet.

- *Can not be used when worksurface tops are attached to flip top legs.*

Required Specifications

Top Finish
Edge Finish

Optional Specifications

Grommet

Accessories

Power Block

MODESTY PANEL WITH WIRE MANAGEMENT

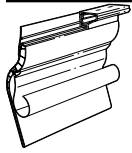

Modesty Panel with Wire Management

MODEL#	DIMENSIONS D x W x H	FREIGHT CLASS	WT./LBS.	CUBIC FT.	LIST PRICE
CNCC2430	2.75 x 35 x 11.75	100	4.30	.50	\$203
CNCC3036	2.75 x 43 x 11.75	100	5.10	.60	\$231
CNCC3642	2.75 x 53 x 11.75	100	6	.70	\$299

For use with **CNC crescent tops**. 11 3/4" high, Black plastic, attractive ribbed design. Includes two fold-away installation clips and flexible privacy strips. Connects to predrilled holes in table top. Can be used with or without wire management grommet.

- *Can not be used when worksurface tops are attached to flip top legs.*

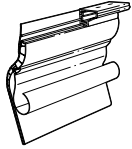

Modesty Panel with Wire Management

CNQC2424	2.75 x 27 x 11.75	100	3.40	.40	\$168
CNQC3030	2.75 x 35 x 11.75	100	4.30	.50	\$203
CNQC3636	2.75 x 44 x 11.75	100	5.10	.60	\$231

For use with **CNC quarter round tops**. 11 3/4" high, Black plastic, attractive ribbed design. Includes two fold-away installation clips and flexible privacy strips. Connects to predrilled holes in table top. Can be used with or without wire management grommet.

- *Can not be used when worksurface tops are attached to flip top legs.*

CNRC2030	2.75 x 29 x 11.75	100	4.30	.50	\$168
CNRC2036	2.75 x 35 x 11.75	100	5.10	.60	\$203
CNRC2042	2.75 x 41 x 11.75	100	6	.70	\$231
CNRC2048	2.75 x 47 x 11.75	100	6.80	.80	\$269
CNRC2054	2.75 x 53 x 11.75	100	7.70	.90	\$299
CNRC2060	2.75 x 59 x 11.75	100	8.50	1	\$333
CNRC2066	2.75 x 65 x 11.75	100	9.40	1.10	\$360
CNRC2072	2.75 x 71 x 11.75	100	10.20	1.20	\$381

CNRC2430	2.75 x 29 x 11.75	100	4.30	.50	\$168
CNRC2436	2.75 x 35 x 11.75	100	5.10	.60	\$203
CNRC2442	2.75 x 41 x 11.75	100	6	.70	\$231
CNRC2448	2.75 x 47 x 11.75	100	6.80	.80	\$269
CNRC2454	2.75 x 53 x 11.75	100	7.70	.90	\$299
CNRC2460	2.75 x 59 x 11.75	100	8.50	1	\$333
CNRC2466	2.75 x 65 x 11.75	100	9.40	1.10	\$360
CNRC2472	2.75 x 71 x 11.75	100	10.20	1.20	\$381

CNRC3036	2.75 x 35 x 11.75	100	5.10	.60	\$203
CNRC3042	2.75 x 41 x 11.75	100	6	.70	\$231
CNRC3048	2.75 x 47 x 11.75	100	6.80	.80	\$269
CNRC3054	2.75 x 53 x 11.75	100	7.70	.90	\$299
CNRC3060	2.75 x 59 x 11.75	100	8.50	1	\$333
CNRC3066	2.75 x 65 x 11.75	100	9.40	1.10	\$360
CNRC3072	2.75 x 71 x 11.75	100	10.20	1.20	\$381

CNRC3642	2.75 x 41 x 11.75	100	6	.70	\$231
CNRC3648	2.75 x 47 x 11.75	100	6.80	.80	\$269
CNRC3654	2.75 x 53 x 11.75	100	7.70	.90	\$299
CNRC3660	2.75 x 59 x 11.75	100	8.50	1	\$333
CNRC3666	2.75 x 65 x 11.75	100	9.40	1.10	\$360
CNRC3672	2.75 x 71 x 11.75	100	10.20	1.20	\$381

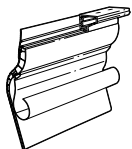

Modesty Panel with Wire Management

For use with **CNR/CNRU rectangular tops**. 11 3/4" high, Black plastic, attractive ribbed design. Includes two fold-away installation clips and flexible privacy strips. Connects to predrilled holes in table top. Can be used with or without wire management grommet.

- *Can not be used when worksurface tops are attached to flip top legs.*

Required Specifications

Top Finish
Leg Finish
Edge Finish

Optional Specifications

Grommet

Accessories

Power Block

MODESTY PANEL WITH WIRE MANAGEMENT

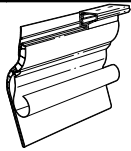

Modesty Panel with Wire Management

MODEL# DIMENSIONS FREIGHT CLASS WT/LBS. CUBIC FT. LIST PRICE

D x W x H

CNSC2424	2.75 x 23 x 11.75	100	3.50	.40	\$139
CNSC3030	2.75 x 29 x 11.75	100	4.30	.50	\$168
CNSC3636	2.75 x 35 x 11.75	100	5.10	.60	\$203

For use with **CNC square tops**. 11 3/4" high, Black plastic, attractive ribbed design. Includes two fold-away installation clips and flexible privacy strips. Connects to predrilled holes in table top. Can be used with or without wire management grommet.

- *Can not be used when worksurface tops are attached to flip top legs.*

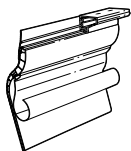

Modesty Panel with Wire Management

CNTC2048L	2.75 x 43 x 11.75	100	6.80	.80	\$231
CNTC2060L	2.75 x 55 x 11.75	100	8.50	1	\$299
CNTC2448L	2.75 x 43 x 11.75	100	6.80	.80	\$231
CNTC2460L	2.75 x 55 x 11.75	100	8.50	1	\$299
CNTC3060L	2.75 x 55 x 11.75	100	8.50	1	\$299
CNTC3072L	2.75 x 67 x 11.75	100	10.20	1.20	\$360
CNTC3660L	2.75 x 55 x 11.75	100	8.50	1	\$299
CNTC3672L	2.75 x 67 x 11.75	100	10.20	1.20	\$360

For use with **long side of CNT trapezoid tops**. 11 3/4" high, Black plastic, attractive ribbed design. Includes two fold-away installation clips and flexible privacy strips. Connects to predrilled holes in table top. Can be used with or without wire management grommet.

- *Can not be used when worksurface tops are attached to flip top legs.*

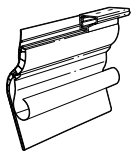

Modesty Panel with Wire Management

CNTC2048S	2.75 x 24 x 11.75	100	3.40	.40	\$139
CNTC2060S	2.75 x 36 x 11.75	100	3.50	.50	\$203
CNTC2448S	2.75 x 23 x 11.75	100	3.40	.40	\$139
CNTC2460S	2.75 x 35 x 11.75	100	3.40	.40	\$203
CNTC3060S	2.75 x 29 x 11.75	100	4.30	.50	\$168
CNTC3072S	2.75 x 41 x 11.75	100	4.30	.50	\$231
CNTC3660S	2.75 x 23 x 11.75	100	5.10	.60	\$139
CNTC3672S	2.75 x 35 x 11.75	100	5.10	.60	\$203

For use with **short side of CNT trapezoid tops**. 11 3/4" high, Black plastic, attractive ribbed design. Includes two fold-away installation clips and flexible privacy strips. Connects to predrilled holes in table top. Can be used with or without wire management grommet.

- *Can not be used when worksurface tops are attached to flip top legs.*

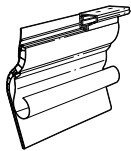

Modesty Panel with Wire Management

CNWC2424	2.75 x 17 x 11.75	100	3.40	.40	\$114
CNWC3030	2.75 x 22 x 11.75	100	4.30	.50	\$139

For use with **CNW wedge tops**. 11 3/4" high, Black plastic, attractive ribbed design. Includes two fold-away installation clips and flexible privacy strips. Connects to predrilled holes in table top. Can be used with or without wire management grommet.

- *Can not be used when worksurface tops are attached to flip top legs.*

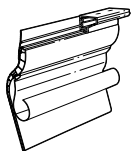

Modesty Panel with Wire Management

CNYC2424	2.75 x 22 x 11.75	100	3.40	.40	\$139
CNYC3030	2.75 x 27 x 11.75	100	4.30	.50	\$168

For use with **CNY triangle tops**. 11 3/4" high, Black plastic, attractive ribbed design. Includes two fold-away installation clips and flexible privacy strips. Connects to predrilled holes in table top. Can be used with or without wire management grommet.

- *Can not be used when worksurface tops are attached to flip top legs.*

Required Specifications

Top Finish
Leg Finish
Edge Finish

Optional Specifications

Grommet

Accessories

Power Block

T LEGS

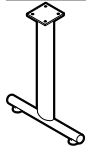

"T" Leg

MODEL#	DIMENSIONS D x W x H	FREIGHT CLASS	WT./LBS.	CUBIC FT.	LIST PRICE
GCNTLEG18	5.25 x 18 x 27.63	125	15	2.10	\$214
GCNTLG18P	5.25 x 18 x 27.63	125	17	2.10	\$422

18" long with plastic elliptical column cover, leveling glides and end caps. **For assembly with 20" tops.**

- For a single leg, order **GCNTLEG18**.
- For a pair of legs (set of 2), order **GCNTLG18P**.
- Chrome (CH) is available (on foot only). **Add \$76** list for model GCNTLEG18 and **\$145** list for model GCNTLG18P.

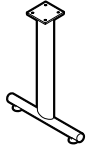

"T" Leg

GCNTLEG24	5.25 x 20 x 27.63	150	9	2.10	\$214
GCNTLG24P	5.25 x 20 x 27.63	100	17	2.10	\$422

20" long with plastic elliptical column cover, leveling glides and end caps. **For assembly with 24" tops.**

- For a single leg, order **GCNTLEG24**.
- For a pair of legs (set of 2), order **GCNTLG24P**.
- Chrome (CH) is available (on foot only). **Add \$76** list for model GCNTLEG24 and **\$145** list for model GCNTLG24P.

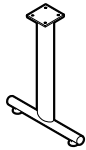

"T" Leg

GCNTLEG30	5.25 x 26 x 27.63	250	10	2.60	\$231
GCNTLG30P	5.25 x 26 x 27.63	125	19	2.60	\$460

26" long with plastic elliptical column cover, leveling glides and end caps. **For assembly with 30" tops.**

- For a single leg, order **GCNTLEG30**.
- For a pair of legs (set of 2), order **GCNTLG30P**.
- Chrome (CH) is available (on foot only). **Add \$76** list for model GCNTLEG30 and **\$145** list for model GCNTLG30P.

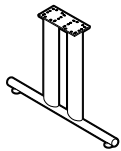

"T" Leg

GCNTLEG36	5.75 x 32 x 27.63	150	14	3.30	\$465
GCNTLG36P	5.25 x 32 x 27.63	100	27	3.30	\$923

32" long with double post plastic elliptical column cover, leveling glides and end caps. **For assembly with 36" tops.**

- For a single leg, order **GCNTLEG36**.
- For a pair of legs (set of 2), order **GCNTLG36P**.
- Chrome (CH) is available (on foot only). **Add \$76** list for model GCNTLEG36 and **\$145** list for model GCNTLG36P.

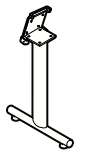

Flip Top "T" Leg

CNTFLEG18	5.25 x 18 x 27.63	150	10	2.40	\$400
-----------	-------------------	-----	----	------	--------------

18" long with plastic elliptical column cover, leveling glides and end caps. **For assembly with 20" deep rectangular and square tops only.** Hinged plate with locking mechanism to lock in open or closed position. Cannot be installed with thumbscrews.

- *Can not be used when modesty panels and wire management are attached to worksurface tops.*
- List Price is per **each leg**.
- Chrome (CH) is available (on foot only). **Add \$76** list

Required Specifications
Leg Finish

T LEGS

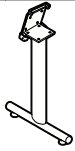

Flip Top "T" Leg

MODEL#	DIMENSIONS D x W x H	FREIGHT CLASS	WT/LBS.	CUBIC FT.	LIST PRICE
--------	-------------------------	---------------	---------	-----------	------------

CNTFLEG24	6.5 x 20 x 27.62	150	10	2.40	\$400
-----------	------------------	-----	----	------	--------------

20" long with plastic elliptical column cover, leveling glides and end caps. **For assembly with 24" deep rectangular and square tops only.** Hinged plate with locking mechanism to lock in open or closed position. Cannot be installed with thumbscrews.

- Can not be used when modesty panels and wire management are attached to worksurface tops.
- List Price is per **each leg**.
- Chrome (CH) is available (on foot only). **Add \$76** list

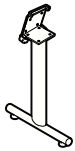

Flip Top "T" Leg

CNTFLEG30	6.5 x 26 x 27.62	150	14	3	\$422
-----------	------------------	-----	----	---	--------------

26" long with plastic elliptical column cover, leveling glides and end caps. **For assembly with 30" deep rectangular and square tops only.** Hinged plate with locking mechanism to lock in open or closed position. Cannot be installed with thumbscrews.

- Can not be used when modesty panels and wire management are attached to worksurface tops.
- List Price is per **each leg**.
- Chrome (CH) is available (on foot only). **Add \$76** list

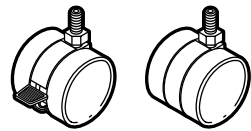

Casters

CNCP	- x - x 1.5	70	1	.15	\$44
------	-------------	----	---	-----	-------------

Set of (2) 1½" dual wheel casters, one locking. Suggested for hard floor surfaces and industrial carpeting. Casters are fully interchangeable with glides. Black only.

- For use with *ConnecTABLES* units only.
- Casters **DO NOT** affect table height.



Thumbscrews

CNTS	1.25 x 1.25 x 1.5	70	1	.15	\$28
------	-------------------	----	---	-----	-------------

Triangular thumbscrew with ¾" steel thread. Set of 4. Can be used in place of factory supplied screws to allow installation of "T" legs to tops without tools. Black only.

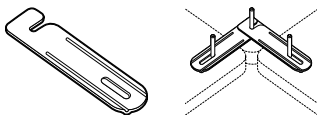

Ganging Connector

CNGFP	5 x 2.5 x 1.13	70	.20	.10	\$49
-------	----------------	----	-----	-----	-------------

Black epoxy coated 13 gauge steel with 2 thumbscrews included. Used to connect tabletops together for additional stability or for connecting freestanding tops together. Holes with steel inserts are located in the corner of all tops to accommodate this plate. **Sold individually.**

Required Specifications

Leg Finish



Duet tables are multi-purpose stacking tables that offer optimum space utilization and flexibility. Their personality and simple design make them ideal for use in any learning or training environment at post-secondary and adult levels. Temporarily and easily convert auditoriums and other spaces into examination and seminar spaces. They can be partnered with stacking chairs such as Duet or Popcorn in matching or complementary colors (stacking chairs can be found in the Multi-Purpose section of the Seating price list).

The one-piece molded top and modesty are gently contoured providing an eased edge with an elegant waterfall transition from top to modesty.

Tops are available in a wide array of colors in 0.5" thick polypropylene. Polypropylene material offers strength and ease of cleaning with a slightly textured surface to offer scratch resistance.



Features and Benefits

- One-piece molded top and modesty are 0.5" thick polypropylene.
- Tables are rated 250 lbs. capacity.
- Surface includes factory installed metal inserts for solid and secure connection to the sled frame.
- 0.5" diameter solid steel rod sled frame.
- Bumpers on the underside for protection when stacking.
- Model with ADA width compliant frame is available.
- Shipped fully assembled.



One-piece top and modesty.



Stacks 5 high on floor or 20 high on dolly.



Ganging frame to keep tables evenly aligned.

GENERAL INFORMATION

- Duet tables are multi-purpose stacking tables ideal for auditoriums, seminars or any learning or training environment.
- Lightweight and easy to handle whether stacking for storage or setting up a room.
- Made of durable materials to withstand more demanding environments.
- Shipped fully assembled. Packaged 4 per carton.
- Global products are in compliance with stringent emission guidelines set out by the Greenguard Environmental Institute under the standards for low emitting products and materials. www.greenguard.org.
- Covered by Global's Lifetime Warranty.
- **Level 2 Certified.**

WORKSURFACES

- Top and modesty are a one-piece injection molded design in 0.5" thick polypropylene.
- Available in a wide array of colors (see right column "FINISHES") to complement any space or to define sections by color.
- One-piece molded top and modesty are contoured providing an eased user edge, with an elegant waterfall transition from top to modesty.

26"W x 18"D x 9.75"H

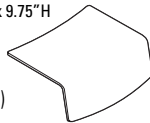

FINISHES

BZB	Buzz Blue	FRO	Frost
CCT	Cactus	INK	Ink
CRO	Carrot	LAB	Latte
IVC	Cloud	BLK	Night
DJN	Dijon	SND	Sand
EGP	Eggplant	SAR	Scarlet
FOG	Fog	SHW	Shadow

CONSTRUCTION

- Surface includes molded in threaded inserts to provide a secure metal-to-metal connection to the sled frame.
- Bumpers are included on the underside of top and inside modesty to protect surfaces when stacking.

FRAME

- 0.5" diameter solid steel rod sled frame.
- Available in a durable Chrome finish.
- Model with ganging frame keeps tables evenly positioned and aligned. No tools or fasteners required for ganging; the frames simply interlock.
- Model with ADA compliant frame is also available. The frame is 33" wide and the polypropylene top/modesty remain a constant size.
- Tables are standard without glides and are suitable for carpet, rubber or cork flooring.
- Glide options are available (see right column "GLIDES"). Glides must be chosen to best suit flooring type and site conditions. Upcharges apply.

DOLLY

- For space saving storage and transport.
- Constructed from 1.5" x 0.5" steel tubing with heavy duty casters (two locking) and a removable handle.
- Dolly can stack up to 20 tables.
- Stacking height on dolly is up to 68".

GLIDES

CG	Clear polycarbonate (for carpet, rubber or concrete flooring). Height added to table: 0.18". Add \$12/set.
SG	Glides with stainless steel pads (for carpet or rubber flooring). Height added to table: 0.17". Add \$23/set.
FG	Glides with felt pads (for vinyl, cork or laminate flooring). Height added to table: 0.24". Add \$23/set.
RG	Glides with rubber pads (for vinyl, hardwood, laminate, stone or ceramic flooring). Height added to table: 0.16". Add \$23/set.

SPECIFICATIONS

- Specifications marked with an * are applicable to only those products which have the * symbol beside the product name.

EXAMPLE DUET TABLE ORDER CODE:

Duet stacking table, polypropylene surface in Latte, clear polycarbonate glides

DTS1828P	-LAB	-CG
Model #	Surface finish	Glides

D DUET™ TABLES

STACKING TABLES

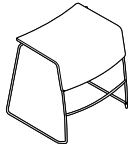

Stacking Table*

MODEL#	DIMENSIONS D x W x H	FREIGHT CLASS	WT./LBS.	CUBIC FT.	LIST PRICE
DTS1828P	25 x 29 x 28	150	26	17.75	\$359

One-piece polypropylene top and modesty with Chrome frame. Shipped fully assembled, 4 per carton.

- Price shown is per table. It is recommended to order in multiples of 4.
- Please be sure to select the appropriate glide (see previous page) for the flooring surface, as scratches could occur.
- Worksurface is 18"D x 28"W

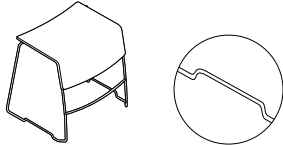

Stacking Table, Ganging Frame*

DTS1828PG	25 x 30.75 x 28	150	26	17.75	\$383
-----------	-----------------	-----	----	-------	--------------

One-piece polypropylene top and modesty with Chrome ganging frame. Shipped fully assembled, 4 per carton.

- Price shown is per table. It is recommended to order in multiples of 4.
- Please be sure to select the appropriate glide (see previous page) for the flooring surface, as scratches could occur.
- Worksurface is 18"D x 28"W

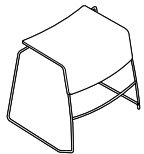

Stacking Table, 32" Wide*

DTA1832P	25 x 33 x 28	150	26	17.75	\$406
----------	--------------	-----	----	-------	--------------

ADA (American with Disabilities Act) compliant. 33" wide. One-piece polypropylene top and modesty with Chrome frame. Underside clearance is 27.1"H (extra height if glides are selected). Stacks up to 5 high on floor only; dolly does not accommodate. Shipped fully assembled, 4 per carton.

- Price shown is per table. It is recommended to order in multiples of 4.
- Please be sure to select the appropriate glide (see previous page) for the flooring surface, as scratches could occur.
- Worksurface is 18"D x 32"W

DOLLY



Dolly

MODEL #	DIMENSIONS	FREIGHT CLASS	WT./LB.	CUBIC FT.	LIST PRICE
DTD20	29.5 x 63 x 38.5	250	50	21	\$523

For use with tables DTS1828P and DTS1828PG. Can stack up to 20 tables. Black only. Removable handle for storage. Shipped fully assembled in 1 carton.

Required Specifications
Finish

Optional Specifications
Grommet

Accessories
Power Block



Edventure is a value series collection that offers a range of teacher desks, student desks, study carrels and lecterns for more traditional learning environments. Designed to withstand daily rigorous use, traditional style meets modern performance.

Tops are available in a wide array of finishes in 1" thick thermally fused laminate or 1 1/16" high pressure laminate with matching or complementary 2mm PVC edgebanding. Edventure's color palette also includes nine new bold finishes available on select components in high pressure laminate only.

Mobile lecterns and teacher desks offer versatility with storage options for educators on the move.

Single and connecting study carrels create quiet work areas with optional power and data to stay connected.



Features and Benefits

- Tops are 1" thick thermally fused laminate or 1 1/16" high pressure laminate.
- Tops are constructed of 45 lb. density particle board.
- Matching or complementary 2mm PVC edgebanding.
- Surfaces include factory installed metal inserts for solid and secure leg connections.
- H-leg design on teacher and student desks.
- Teacher's desk includes modesty panel and is available with or without casters.
- Teacher's desk with left or right hand box/box/file pedestal available on casters only.
- Study carrel features curved side panels for seated privacy with a 29"H worksurface.
- Easy to assemble.



H-legs with cross bar.



Mobile teacher desk with modesty panel.



Freestanding and add-on study carrels.

GENERAL INFORMATION

- Edventure series is an affordable collection of teacher desks, student desks, study carrels and lecterns with personal storage options, that bring a traditional element to the classroom.
- Simple and elegant design respects space requirements to accommodate various teaching styles.
- Edventure series is a high achiever, built to withstand the most demanding environments.
- Shipped easy to assemble.
- For environmental certifications, please visit globalfurnituregroup.com

WORKSURFACES

- Tops are available in 1" thick thermally fused laminate or 1 1/16" thick high pressure laminate.
- Available in an array of finishes in both thermally fused laminate or high pressure laminate. Color palette also includes nine new bold finishes available for high pressure laminate only; a complementary edge finish must be selected.
- Products specified with the high pressure laminate option are finished on the underside of the surface with a kraft paper backing.

CONSTRUCTION

- Top core is made of 45 lb. density particle board.
- Surfaces include factory installed metal inserts for solid and secure leg connections.

EDGE DETAIL

- Global's preferred 2mm PVC edgebanding is standard.
- Edgebanding may be specified in a matching or a complementary finish for tops in standard Global laminates.

LEGS

- H-legs are 28" high and constructed from 2" x 2" square tubing with a 1" x 2" rectangular cross bar and adjustable leveling glides.
- Available in Black (**BLK**), Designer White (**DWT**) or Tungsten (**TUN**) painted finishes, Sandtex finish applied.

CASTERS

- Teacher desks and lecterns are available with locking casters. See models ending in C.
- Casters are 3.5" high overall.

MODESTY PANELS

- Modesty panel is included with teacher desks.
- Available in an array of finishes in thermally fused laminate with matching edges only.

STORAGE LECTERNS

- The steel storage lectern features integrated full pulls and a full welded seamless top for added strength and crisp appearance.
- Drawer and door fronts have welded reinforcements for additional strength.
- Available in three configurations, offering multiple storage options for storing personal items or keeping active files and resource materials close at hand.
- Removable cam locks are standard.
- Storage lecterns are supported by 2" x 2" x 3.5"H square tube legs on leveling glides or 3.5"H industrial size casters.
- Finished laminate tops to complement desking are available. See model ENMST1824.
- An optional lectern shelf offers a perfect platform for keeping presentation materials organized and at the presenter's fingertips. See model ENLS182.

STUDY CARRELS

- The study carrel features a 29" high worksurface and curved side panels for privacy.
- Freestanding (starter) and add-on models are available. Legs and privacy panels are shared between adjoining add-on carrels.
- The back panel is inset to hide connecting fasteners from user's view. The inset back also creates a wire drop for the optional LED task light cord.
- Carrels with an optional shelf are available. See models ending in **S**.
- Optional LED task light is available for carrel with shelf, see page page 660
- Optional Cove Daisylink system is available to bring power, USB charging or data to the carrel surface for desktop access, see page 662

GROMMETS

- Optional grommets are available in standard worksurface locations (left, center or right). Order as: **AG1, AG2** or **AG3**. **Add \$69**.
- Grommet hole dimensions are 3.25"W x 1.875"D
 - ENSTxxxx, ENAC2924/3524, ENFC3024/3624 models - **AG2** option only
 - ENFC6024/7224, ENFC5924/7124 models - **AG1 and AG3** option only

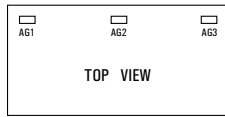
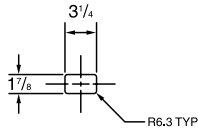

VILLA CUTOUTS

- Optional Villa cutout available in standard worksurface locations (left, center or right) for Rectangular tables. Order as: **V1, V2** or **V3** - **Add \$69 for each cutout**.
 - ENSTxxxx, ENAC2924/3524, ENFC3024/3624 models - **V2** option only
 - ENFC6024/7224, ENFC5924/7124 models - **V1 and V3** option only

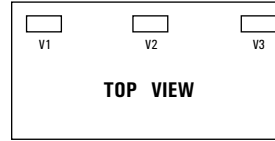

POWER BLOCK

- A power block is a rectangular worksurface power/data module with one electrical duplex receptacle and two data (RJ45) receptacles. 9' Black cord included. Power block dimensions are 6.5"W x 3.5"D x 2.75"H.
 - ENSTxxxx, ENAC2924/3524, ENFC3024/3624 models - **E2** option only
 - ENFC6024/7224, ENFC5924/7124 models - **E1 and E3** option only

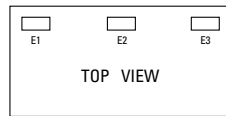
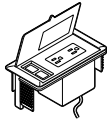

Power block **PMSPDM**. **Add \$261**. Specify location **E1, E2** or **E3**. **Add \$69**.

COVE DAISYLINK COMPONENTS

- A daisy-chain power solution with a unique "no particular order" feature, making installation or reconfiguration easy.
- Cove Daisylink modules must be ordered separately and are available for study carrels only.
- Specify the cut-out for Cove Daisylink modules when ordering the study carrels; order the Cove kits (modules and jumpers) and infeed separately.
- When **CV** cut-out is specified on 29", 30", 35" and 36" study carrels, **one** cut-out in the center position is included. **Add \$69**.
When **CV** cut-out is specified on 59", 60", 71" and 72" study carrels, **two** cut-outs in the left and right positions are included. **Add \$138**.
- For Cove Daisylink components, see page 662
- Maximum of 9 Cove modules per each infeed.

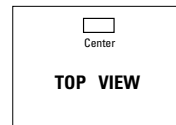

29", 30", 35" and 36" study carrels

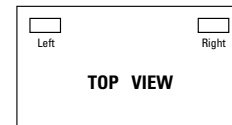

59", 60", 71" and 72" study carrels

SPECIFICATIONS

- Specifications marked with an * are applicable to only those products which have the* symbol beside the product name.

FINISHES

Thermally Fused or High Pressure Laminate Tops and 2mm Thick Edgebanding

ACJ	Absolute Acajou	HGT	Hayden Grey
ASN	Asian Night	QTM	Quartered Mahogany
AWC	Avant Cherry	SOG	Storm Grey
AWH	Avant Honey	TFW	Tiger Fruitwood
BLK	Black	TWL	Tiger Walnut
BRC	Brushed Cobalt	WHE	Walnut Heights
CMB	Clear Maple	WHC	White Chocolate
DES	Dark Espresso	WCR	Winter Cherry
DWT	Designer White		

Note: Modesty panel and lectern shelf are available in thermally fused laminate finishes only.

Modesty panel and pedestal edging will match TFL finish specified.

High Pressure Laminate Finishes - Tops only

BTT	Blue Titanium	KKW	Kool Kiwi
BBY	Blueberry	LBR	Liberty Red
CBB	Caribbean Blue	MYL	Morning Yellow
FJT	Fiji Teal	RPL	Royal Purple
FPY	Fresh Papaya		

Legs and Storage Lectern Metal Trim Finishes

BLK	Black
DWT	Designer White
TUN	Tungsten

Painted Finishes for Metal Storage Lecterns

BLK	Black	F30	Ivory
U04	Black Coffee*	LGR	Light Grey
F29	Bone	J52	Mocha*
BGR	Business Grey	F07	Metro
T20	Cappuccino*	F05	Moss
CGR	Charcoal Grey	F19	Navy
F09	Claret	NEV	Nevada
F23	Cloud	F35	Oyster
T19	Dark Chocolate*	F32	Stone
DPT	Desert Putty	TSA	Tahiti Sand
DWT	Designer White	TU2	Tungsten 2
GRY	Grey	J23	Vanilla
F33	Ice	F23	Willow

*textured finishes

TO SPECIFY:

1. SPECIFY MODEL NUMBER

2. SPECIFY THE FOLLOWING:

FOR TEACHER AND STUDENT DESKS:

- Top finish
- Optional HP laminate
- Edge finish (top only)
- Modesty finish if applicable
- Pedestal finish if applicable
- Leg finish
- Optional AG grommet or cut-out for PMSPDM, if applicable
- Optional key alike or select number (#100-120) applicable with teacher's desks with pedestals

FOR STORAGE LECTERNS:

- Case painted finish
- Optional key alike
- Feet finish if applicable

FOR STUDY CARRELS:

- Top surface finish (shelf, if applicable, will be in the same finish)
- Optional HP laminate
- Edge finish
- Leg finish
- Surround finish (side and back panels)
- Optional cut-out(s) for Cove Daisylink components

EXAMPLE ADVENTURE ORDER CODES:

Teacher desk

ENTD7230	-ACJ	-HPL	-ACJ	-TUN	-WHT
Model #	Top finish	High pressure laminate	Edge finish	Leg finish	Modesty panel finish

Storage lectern

EL18LPBF	-DWT	-KA	-TUN
Model #	Case finish	Key alike	Feet finish

Study carrel

ENFC3024	-ACJ	-HPL	-ACJ	-TUN	-WHT	-CV
Model #	Top finish	High pressure laminate	Top edge finish	Leg finish	Surround finish	Cut-out for Cove

STORAGE LECTERNS

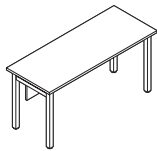

Teacher Desk, 24" D

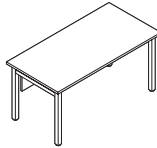

Teacher Desk, 30" D

MODEL#	DIMENSIONS	FREIGHT CLASS	WT/LBS.	CUBIC FT.	LIST PRICE	HP ADD
D x W x H						
ENTD4824	24 x 48 x 29	70	74	4.6	\$782	\$131
ENTD5424	24 x 54 x 29	70	80	4.7	\$793	\$150
ENTD6024	24 x 60 x 29	70	86	4.9	\$804	\$161

Modesty panel included. Shipped easy to assemble in 2 cartons.

ENTD6030	30 x 60 x 29	70	96	6.4	\$855	\$174
ENTD6630	30 x 66 x 29	70	103	6.6	\$885	\$212
ENTD7230	30 x 72 x 29	70	110	6.8	\$914	\$227

Modesty panel included. Shipped easy to assemble in 2 cartons.

MOBILE TEACHER DESKS

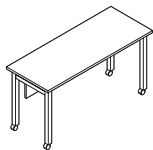

Mobile Teacher Desk, 24" D

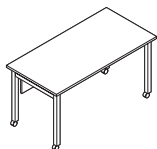

Mobile Teacher Desk, 30" D

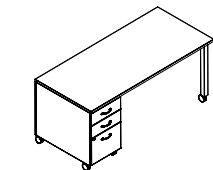

Mobile Teacher Desk, BBF - Left*

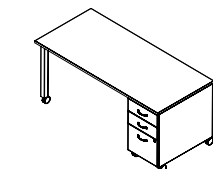

Mobile Teacher Desk, BBF - Right*

MODEL#	DIMENSIONS	FREIGHT CLASS	WT/LB.	CUBIC FT.	LIST PRICE	HP ADD
ENTD4824C	24 x 48 x 29	70	75	4.6	\$909	\$131
ENTD5424C	24 x 54 x 29	70	81	4.7	\$919	\$141
ENTD6024C	24 x 60 x 29	70	87	4.9	\$931	\$152

Modesty panel included. Shipped easy to assemble in 2 cartons.

ENTD6030C	30 x 60 x 29	70	98	5.4	\$982	\$163
-----------	--------------	----	----	-----	--------------	--------------

Modesty panel included. Shipped easy to assemble in 2 cartons.

ET6024BBFLC	24 x 60 x 29	85	155	12.37	\$1746	\$151
ET6624BBFLC	24 x 66 x 29	85	161	12.57	\$1778	\$163
ET7224BBFLC	24 x 72 x 29	85	167	12.75	\$1811	\$173

ET6030BBFLC	30 x 60 x 29	85	193	14.67	\$1845	\$163
ET6630BBFLC	30 x 66 x 29	85	201	14.85	\$1878	\$199
ET7230BBFLC	30 x 72 x 29	85	210	15.06	\$1910	\$213

Inset modesty panel and flush left hand locking box/box/file pedestal included. Top box drawer is non-locking. Top is pre-drilled above the pedestal on the underside for the addition of lectern shelf ENLS182. Shipped easy to assemble (BBF pedestal is fully assembled) in 3 cartons.

ET6024BBFRC	24 x 60 x 29	85	155	12.37	\$1746	\$151
ET6624BBFRC	24 x 66 x 29	85	161	12.57	\$1778	\$163
ET7224BBFRC	24 x 72 x 29	85	167	12.75	\$1811	\$173

ET6030BBFRC	30 x 60 x 29	85	193	14.67	\$1845	\$163
ET6630BBFRC	30 x 66 x 29	85	201	14.85	\$1878	\$199
ET7230BBFRC	30 x 72 x 29	85	210	15.06	\$1910	\$213

Inset modesty panel and flush right hand locking box/box/file pedestal included. Top box drawer is non-locking. Top is pre-drilled above the pedestal on the underside for the addition of lectern shelf ENLS182. Shipped easy to assemble (BBF pedestal is fully assembled) in 3 cartons.

Required specifications

Top finish
Edge finish
Leg finish
Modesty finish
Pedestal finish*

Optional specifications

HP laminate
AG grommet or cut-out for PMSPPM*
Key alike/select key*

Accessories

Lectern shelf*

STUDENT DESK

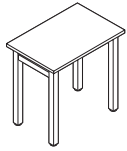

Student Desk**

MODEL#	DIMENSIONS	FREIGHT CLASS	WT/LBS.	CUBIC FT.	LIST PRICE	HP ADD
--------	------------	---------------	---------	-----------	------------	--------

D x W x H	
ENST3020	20 x 30 x 29

Shipped easy to assemble in 2 cartons.

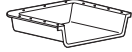

Book Boxes for Student Desk - Set of 5

ENSTBB	11.8 x 17.7 x 4.7	85	11.02	1.42	\$187	N/A
--------	-------------------	----	-------	------	--------------	-----

Open book box for use with student desks. Easy to install. Grey polypropylene only. Shipped in quantity of 5 per carton.

STORAGE LECTERNS

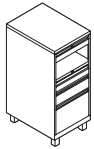

Storage Lectern w/Laptop Drawer*

MODEL #	DIMENSIONS	FREIGHT CLASS	WT/LB.	CUBIC FT.	LIST PRICE
---------	------------	---------------	--------	-----------	------------

EL18LPBF	24 x 18 x 38	85	148	11.7	\$2471
----------	--------------	----	-----	------	---------------

Locking laptop drawer, open shelf, locking personal drawer, box drawer and file drawer. Cord escape on backside for laptop charging. 3.5" high metal legs with leveling glides. Shipped assembled in 1 carton.

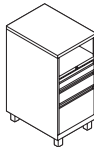

Storage Lectern - Box/File*

EL18PBF	24 x 18 x 38	85	145	11.7	\$2089
---------	--------------	----	-----	------	---------------

Open shelf, locking personal drawer, box drawer and file drawer. 3.5" high metal legs with leveling glides. Shipped assembled in 1 carton.

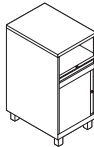

Storage Lectern*

EL18PHDL	24 x 18 x 38	92.5	128	11.7	\$2089
----------	--------------	------	-----	------	---------------

Open shelf, locking personal drawer and **left** side hinged locking door with shelf inside. 3.5" high metal legs with leveling glides. Shipped assembled in 1 carton.

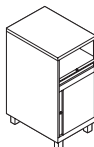

Storage Lectern*

EL18PHDR	24 x 18 x 38	92.5	128	11.7	\$2089
----------	--------------	------	-----	------	---------------

Open shelf, locking personal drawer and **right** side hinged locking door with shelf inside. 3.5" high metal legs with leveling glides. Shipped assembled in 1 carton.

Required specifications

Top finish**
Edge finish**
Painted finish, case
Trim finish, feet*

Optional specifications

HP laminate**
Key alike*

Accessories

Laminate top*
Lectern shelf*
Book box**

MOBILE STORAGE LECTERNS

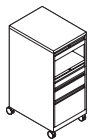

Mobile Storage Lectern w/Laptop Drawer

MODEL # DIMENSIONS FREIGHT CLASS WT/LB. CUBIC FT. LIST PRICE HP ADD

D x W x H

EL18LPBFC	24 x 18 x 38	85	148	11.7	\$2575	
-----------	--------------	----	-----	------	---------------	--

Mobile, locking laptop drawer, open shelf, locking personal drawer, box drawer, file drawer, on four locking casters. Cord escape on back side for laptop charging. Shipped assembled in 1 carton.



Mobile Storage Lectern - Box/File

EL18PBFC	24 x 18 x 38	85	145	11.7	\$2194	
----------	--------------	----	-----	------	---------------	--

Mobile, open shelf, locking personal drawer, box drawer, file drawer, on four locking casters. Shipped assembled in 1 carton.

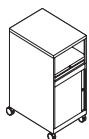

Mobile Storage Lectern*

EL18PHDLC	24 x 18 x 38	92.5	128	11.7	\$2194	N/A
-----------	--------------	------	-----	------	---------------	-----

Mobile, open shelf, locking personal drawer, **left** side hinged locking door with shelf inside, on four locking casters. Shipped assembled in 1 carton.

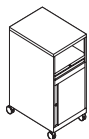

Mobile Storage Lectern*

EL18PHDRC	24 x 18 x 38	92.5	128	11.7	\$2194	N/A
-----------	--------------	------	-----	------	---------------	-----

Mobile, open shelf, locking personal drawer, **right** side hinged locking door with shelf inside, on four locking casters. Shipped assembled in 1 carton.

ACCESSORIES

MODEL # DIMENSIONS FREIGHT CLASS WT/LB. CUBIC FT. LIST PRICE HP ADD

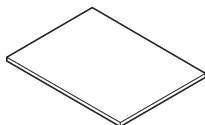

Top for Storage Lectern**

ENMST1824	24 x 18 x 1	60	10.5	0.27	\$157	\$73
-----------	-------------	----	------	------	--------------	-------------

Finished laminate top for storage lecterns. Available in an array of thermally fused laminate or high pressure laminate finishes to complement deskings. Shipped in 1 carton.

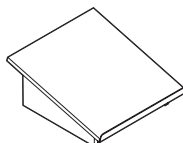

Lectern Shelf**

ENLS182	21 x 18 x 3.25-8.25	125	19	2.55	\$303	N/A
---------	---------------------	-----	----	------	--------------	-----

Offers the perfect platform for keeping lectern materials at the facilitator's fingertips. May be secured to finished top or left unattached to use elsewhere. Screws provided to secure to finished top from the underside. Shipped assembled in 1 carton.

Required specifications

Paint finish, case*
Laminate finish**
Edge finish (ENMST1824 only)
Trim finish (ENLS182 only)

Optional specifications

Key alike*
HP laminate (ENMST1824 only)

FREESTANDING OR STARTER STUDY CARRELS

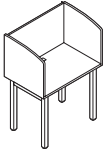

Freestanding/Starter Study Carrel*

MODEL #	DIMENSIONS D x W x H	FREIGHT CLASS	WT/LB.	CUBIC FT.	LIST PRICE	HP ADD	CUT-OUT ADD
ENFC3024	24 x 30 x 51	70	89	4.44	\$764	\$91	\$69
ENFC3624	24 x 36 x 51	70	97.5	4.72	\$798	\$107	\$69
ENFC6024	24 x 60 x 51	70	115	5.8	\$930	\$161	\$138
ENFC7224	24 x 72 x 51	70	123.5	6.34	\$994	\$185	\$138

Features a 29" high worksurface with curved side privacy panels. Shown with optional cut-out. Bring power and USB charging to the user with Cove Daisylink components, see page 662. Shipped easy to assemble in 2 cartons.

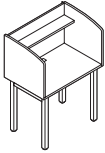

Freestanding/Starter Study Carrel w/Shelf*

ENFC3024S	24 x 30 x 51	70	93	4.44	\$802	\$106	\$69
ENFC3624S	24 x 36 x 51	70	102.5	4.72	\$840	\$124	\$69
ENFC6024S	24 x 60 x 51	70	122	5.8	\$998	\$191	\$138
ENFC7224S	24 x 72 x 51	70	131.5	6.34	\$1072	\$219	\$138

Features a 29" high worksurface with curved side privacy panels. Shown with optional cut-out. Shelf is 6" deep and accepts optional LED task light. Bring power and USB charging to the user with Cove Daisylink components, see page 662. Shipped easy to assemble in 2 cartons.

ADD-ON STUDY CARRELS

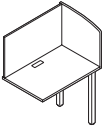

Add-On Study Carrel*

MODEL #	DIMENSIONS	FREIGHT CLASS	WT/LB.	CUBIC FT.	LIST PRICE	HP ADD	CUT-OUT ADD
ENAC2924	24 x 29 x 51	85	63	4.4	\$573	\$91	\$69
ENAC3524	24 x 35 x 51	70	71.5	4.67	\$606	\$107	\$69
ENAC5924	24 x 59 x 51	70	89	5.75	\$743	\$161	\$134
ENAC7124	24 x 71 x 51	70	97.5	6.3	\$808	\$185	\$134

Features a 29" high worksurface with curved side privacy panels. Shown with optional cut-out. Bring power and USB charging to the user with Cove Daisylink components, see page 662. Shipped easy to assemble in 2 cartons.

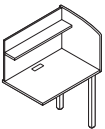

Add-On Study Carrel w/Shelf*

ENAC2924S	24 x 29 x 51	70	67	4.4	\$611	\$106	\$69
ENAC3524S	24 x 35 x 51	70	76.5	4.67	\$649	\$124	\$69
ENAC5924S	24 x 59 x 51	70	96	5.75	\$811	\$191	\$134
ENAC7124S	24 x 59 x 51	70	105.5	6.3	\$885	\$219	\$134

Features a 29" high worksurface with curved side privacy panels. Shown with optional cut-out. Shelf is 6" deep and accepts optional LED task light. Bring power and USB charging to the user with Cove Daisylink components, see page 662. Shipped easy to assemble in 2 cartons.

LED TASK LIGHTS

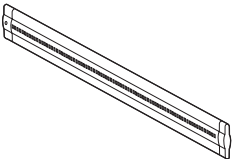

LED Task Light

MODEL #	DIMENSIONS	FREIGHT CLASS	WT/LB.	CUBIC FT.	LIST PRICE
PLED30	1.5 x 15.5 x .5	150	2	.50	\$392
PLED50	1.5 x 23.5 x .5	150	2	.50	\$451
PLED100	1.5 x 43.5 x .5	125	3	.50	\$523

Energy efficient LED. Ultra slim design. Suitable for mounting on the underside of the shelf of a study carrel. 6' power cord.

Required specifications

Top finish*
Edge finish*
Leg finish*
Surround finish*

Optional specifications

HP laminate*
Cut-out for Cove Daisylink modules*

Accessories

Cove Daisylink modules*
LED task lights*

COVE DAISYLINK COMPONENTS

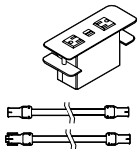

Single Power/USB for 29"/30" Carrels

MODEL# DIMENSIONS FREIGHT CLASS WT/LBS. CUBIC FT. LIST PRICE

D x W x H

ECV2PU30B	2 x 30 x -	60	4.5	0.5	\$495
ECV2PU30S	2 x 30 x -	60	4.5	0.5	\$495

Cove single desktop module with two power outlets and two 2.1A USB charging ports. Includes four cable clamps, one 14" female/male connecting cable and one 14" female/female connecting cable. Connecting cables will daisy-chain modules between two 30" wide starter carrels, one 30" wide starter carrel and one 29" wide add-on carrel, or two 29" wide add-on carrels. Available in Black **(B)** or Silver **(S)** - indicated by last letter of the model number. Infeed to be ordered separately.

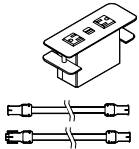

Single Power/USB for 35"/36" Carrels

ECV2PU36B	2 x 36 x -	60	4.6	0.5	\$499
ECV2PU36S	2 x 36 x -	60	4.6	0.5	\$499

Cove single desktop module includes two power outlets and two 2.1A USB charging ports. Includes four cable clamps, one 17" female/male connecting cable and one 17" female/female connecting cable. Connecting cables will daisy-chain modules between two 36" wide starter carrels, one 36" wide starter carrel and one 35" wide add-on carrel, or two 35" wide add-on carrels. Available in Black **(B)** or Silver **(S)** - indicated by last letter of the model number. Infeed to be ordered separately.

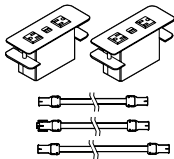

Double Power/USB for 59"/60" Carrels

ECV2PU60B	2 x 60 x -	60	4.6	0.5	\$916
ECV2PU60S	2 x 60 x -	60	4.6	0.5	\$916

Cove double desktop modules - each module includes two power outlets and two 2.1A USB charging ports. Includes four cable clamps, one 12" female/male connecting cable, one 12" female/female connecting cable and one 26" female/female interconnecting cable. Connecting cables will daisy-chain modules between two 60" wide starter carrels, one 60" wide starter carrel and one 59" wide add-on carrel, or two 59" wide add-on carrels. Available in Black **(B)** or Silver **(S)** - indicated by last letter of the model number.

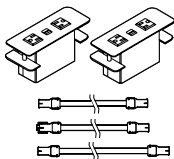

Double Power/USB for 71"/72" Carrels

ECV2PU72B	2 x 72 x -	60	4.6	0.5	\$931
ECV2PU72S	2 x 72 x -	60	4.6	0.5	\$931

Cove double desktop modules - each module includes two power outlets and two 2.1A USB charging ports. Includes four cable clamps, one 15" female/male connecting cable, one 15" female/female connecting cable and one 31" female/female interconnecting cable. Connecting cables will daisy-chain modules between two 72" wide starter carrels, one 72" wide starter carrel and one 71" wide add-on carrel, or two 71" wide add-on carrels. Available in Black **(B)** or Silver **(S)** - indicated by last letter of the model number.

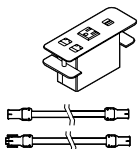

Single Power/Data/USB for 29"/30" Carrels

ECVPUD30B	2 x 30 x -	60	4.6	0.5	\$466
ECVPUD30S	2 x 30 x -	60	4.6	0.5	\$466

Cove single desktop module includes one power outlet, two data knockouts and two 2.1A USB charging ports. Includes four cable clamps, one 14" female/male connecting cable and one 14" female/female connecting cable. Data/telecom options to be ordered separately. Connecting cables will daisy-chain modules between two 30" wide starter carrels, one 30" wide starter carrel and one 29" wide add-on carrel, or two 29" wide add-on carrels. Available in Black **(B)** or Silver **(S)** - indicated by last letter of the model number. Infeed to be ordered separately.

COVE DAISYLINK COMPONENTS

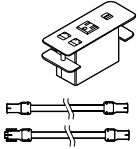

Single Power/Data/USB for 35"/36" Carrels

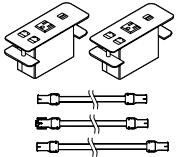

Double Power/Data/USB for 59"/60" Carrels

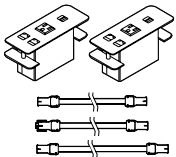

Double Power/Data/USB for 71"/72" Carrels



Single-Circuit Corded Infeed, 72"



Multi-Circuit Power Hardwire Infeed, 72"

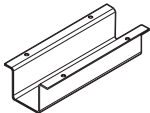

Jumper Guards - Set of 4

MODEL#	DIMENSIONS D x W x H	FREIGHT CLASS	WT/LBS.	CUBIC FT.	LIST PRICE
ECVPUD36B	2 x 36 x -	60	4.60	0.5	\$472
ECVPUD36S	2 x 36 x -	60	4.60	0.5	\$472

Cove single desktop module includes one power outlet, two data knockouts and two 2.1A USB charging ports. Includes four cable clamps, one 17" female/male connecting cable and one 17" female/female connecting cable. Data/telecom options to be ordered separately. Connecting cables will daisy-chain modules between two 36" wide starter carrels, one 36" wide starter carrel and one 35" wide add-on carrel, or two 35" wide add-on carrels. Available in Black (B) or Silver (S) - indicated by last letter of the model number. Infeed to be ordered separately.

ECVPUD60B	2 x 60 x -	60	4.6	0.5	\$862
ECVPUD60S	2 x 60 x -	60	4.6	0.5	\$862

Cove double desktop modules - each module includes one power outlet, two data knockouts and two 2.1A USB charging ports. Includes four cable clamps, one 12" female/male connecting cable, one 12" female/female connecting cable and one 26" female/female interconnecting cable. Data/telecom options to be ordered separately. Connecting cables will daisy-chain modules between two 60" wide starter carrels, one 60" wide starter carrel and one 59" wide add-on carrel, or two 59" wide add-on carrels. Available in Black (B) or Silver (S) - indicated by last letter of the model number. Infeed to be ordered separately.

ECVPUD72B	2 x 72 x -	60	4.6	0.5	\$871
ECVPUD72S	2 x 72 x -	60	4.6	0.5	\$871

Cove double desktop modules - each module includes one power outlet, two data knockouts and two 2.1A USB charging ports. Includes four cable clamps, one 15" female/male connecting cable, one 15" female/female connecting cable and one 31" female/female interconnecting cable. Data/telecom options to be ordered separately. Connecting cables will daisy-chain modules between two 72" wide starter carrels, one 72" wide starter carrel and one 71" wide add-on carrel, or two 71" wide add-on carrels. Available in Black (B) or Silver (S) - indicated by last letter of the model number. Infeed to be ordered separately.

42AP1-72	72"W	70	1	1.80	\$189
----------	------	----	---	------	--------------

72" corded infeed to start a run of Cove Daisylink modules. Maximum of 9 Cove modules per each infeed (Cove double counts as two modules).

42SB2-72	72"W	70	1	1.80	\$122
----------	------	----	---	------	--------------

Hardwire infeed to start a run of Cove Daisylink modules. Maximum of 9 Cove modules per each infeed (Cove double counts as two modules). Certified electrician required for installation.

ENCVG12	5 x 12 x 3.1	85	14	1.1	\$97
---------	--------------	----	----	-----	-------------

Metal channel to protect jumper connection to Cove Daisylink module. Black only. Mounts directly to the underside of surface.



FreeFit offers a universal freestanding design with finish options on bases and surfaces that allow you to easily integrate with existing Global workstation configurations, becoming a part of your workspace. With two concealed motors on each base, FreeFit adjusts at 1.5" per second while emitting just 55db. A "whisper quiet" option emits just 38db – about as quiet as a library. Select from two table ranges – standard range accommodates most users, while extended range meets BIFMA ergonomics guidelines accommodating an extensive array of user needs.



Add a 3rd leg kit to create an electric height adjustable L station.



Features and Benefits

- Tops are 1" thick thermally fused laminate or 1 1/16" high pressure laminate
- Tops are constructed of 45 lb. density particle board
- Worksurfaces are sold separate from the base
- Steel constructed leg tubing, feet and cross bar
- Table frames include expandable width upper cross bars
- Motors daisy-chain and connect directly to one another, without the need for a control box
- Standard up/down handset. Optional digital readout handset.

GENERAL INFORMATION

- FreeFit Height Adjustable Tables allow for easy movement from sitting to standing and back throughout the day.
- FreeFit offers a universal freestanding design with finish options on the bases and surfaces that allow you to easily integrate with existing Global workstation configurations, becoming a part of your office space.
- Can be used alone or in conjunction with Global desks. Please note Global desks are 1" or 1.5" thick
- Global laminate products are in compliance with stringent emission guidelines set out by the Greenguard Environmental Institute under the standards for low emitting products and materials. www.greenguard.org.
- **Level 3 Certified.**

CONSTRUCTION

- 1" thick tops constructed of 45 lb. density particle board with high performance thermally fused laminate.
- All worksurfaces feature Global's preferred matching edge.
- Products specified with the high pressure laminate option are 1-1/16" thick and finished on the underside of the surface with a kraft paper backing.
- Worksurface sizes are "nominal". Main worksurface sizes are 1" less in depth and 2" less in width. Return worksurface sizes are 1" less in depth and 1" less in width.
- Steel constructed leg tubing, feet and cross bar.
- Table frame designed with 3.15" x 2.35" rectangular outer leg with the larger tube attached to the foot.
- Foot is 3.55"W x 1"H (with glides fully recessed).
- Includes 1/2" adjustable glides
- Casters available, specified separately

BASE

- Worksurfaces are sold separate from the base.
- Select width of base: 34W, 40W, 46W, 52W, 58W, 64W and 70W. No upcharge.
- Powder coat finishes for bases is standard in Designer White (**DWT**), Black (**BLK**) or Tungsten (**TUN**).
- Standard Range Tables have 2-stages and feature an adjustment range of 26.91" – 45.2" (18.29" travel).
- Extended Range Tables have 3-stages and feature an adjustment range of 22.57" – 48.75" (26.18" travel).
- Lifts 265 pounds.
- Operates at 1.5" per second.
- Shadow power draw is 0.45 watts.
- Maximum power draw is 1.3 amps.
- Open base design has no lower crossbars.
- Table frames include expandable width upper cross bars.
- All products meet or exceed ANSI-BIFMA X5.5-2008 and 7.1 VOC., UL 962 and CSA-C22.2 No. 6809, CAN/CGSB-44.228-2008.
- All Extended Range tables meet the BIFMA G1-2013 Ergonomic Guideline for "recommended input adjustment range."
- All bases feature a dual actuator system with a motor driving each leg.
- Motors daisy-chain and connect directly to one another, without the need for a control box.

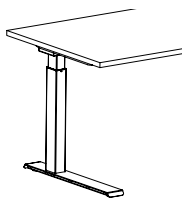

Standard range (2 stage)

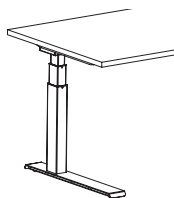

Extended range (3-stage)

HANDSET

- Standard up/down handset (**SH**) (no digital readout). Black only.
- A Joggle Wheel Digital Handset with five programmable settings is optional, specify Digital Readout Handset (**DH**). Add **\$188**. Silver Only.
 - Digital Readout Handset (**DH**) is recommended when items above or below worksurface might impede full movement of the table. DH includes settings to program Upper and Lower Limits, Collision Detection, Sit Position and Stand Position

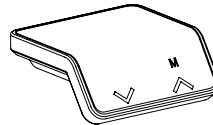

Standard handset (**SH**)

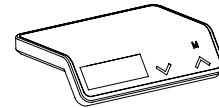

Digital readout handset (**DH**)

FOOT TYPE

- FreeFit Electric Height Adjustable Bases come with an option for foot type.
- Foot Type is available as a "T-Foot" (**T**) or "C-Foot" (**C**) configuration at no upcharge.
- T-Foot configuration has the column centered on the foot.
- C-Foot configuration has the column offset away from the user's position.
 - C-Foot is recommended for any 90 degree configuration

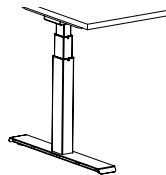

T-foot configuration (**T**)

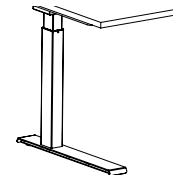

C-foot configuration (**C**)

NOISE REDUCTION

- Industry leading operating sound level of 55dB is standard (**SI**).
- Optional whisper quiet sound insulation reduces level to operating sound level to 38dB. Specify Whisper Quiet Insulation (**QI**). Add **\$42** for FFHATRE and FFHATRS. Add **\$84** for FFHATE24, FFHATE30, FFHATES24, FFHATES30.

FOOT CONFIGURATION

- FreeFit Electric Height Adjustable Bases come with an option for a mixed foot configuration, to be utilized when a 3rd leg kit (for a return) is specified
- If the main worksurface and the return surface are the same depth, please specify Standard Foot Configuration (**SFC**).
- Standard Foot Configuration (**SFC**) provides two feet in the appropriate size for a main worksurface.
 - 24"D Tables receive two feet of 21.75"
 - 30"D Tables receive two feet of 27.60"
- Mixed Foot Configuration (**MFC**) provides one foot in the appropriate size for a main worksurface, and another foot in the appropriate size of a return worksurface.
 - 24"D Tables with MFC option receive one foot for the main worksurface, 21.75", and another foot for a 30"D return surface, 27.60"
 - 30"D Tables with MFC option receive one foot for the main worksurface, 27.60", and another foot for a 24"D return surface, 21.75"

Use SFC

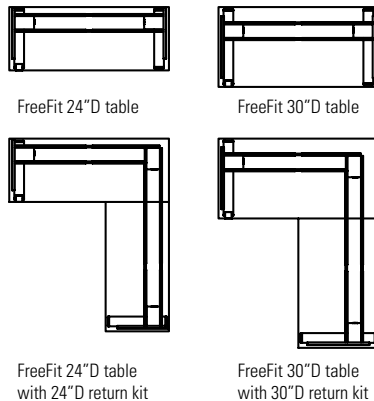

Use MFC

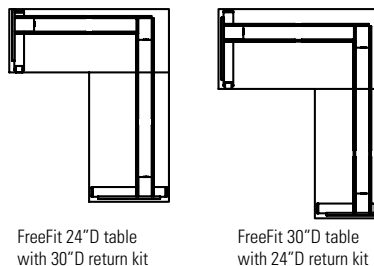

RETURNS

- Return worksurfaces are sold separately from the 3rd leg kit.
- Third leg kits available for both Standard and Extended Range Height Adjustable Tables.
- Post leg will replace one of the legs on the freestanding table, the leg from one side of the freestanding table is then moved to support one side of the return top.
- Cross bar is included to connect and support the return top to the freestanding table top.
- May be configured as left or right hand returns

FINISHES

Thermally Fused or High Pressure Laminate Tops

ACJ	Absolute Acajou	HGT	Hayden Grey
ASN	Asian Night	QTM	Quartered Mahogany
AWC	Avant Cherry	SOG	Storm Grey
AWH	Avant Honey	TFW	Tiger Fruitwood
BLK	Black	TWL	Tiger Walnut
BRC	Brushed Cobalt	WHE	Walnut Heights
CMB	Clear Maple	WHC	White Chocolate
DES	Dark Espresso	WCR	Winter Cherry
DWT	Designer White	WGY	Willow Grey

Base Finishes

BLK	Black
DWT	Designer White
TUN	Tungsten

GROMMETS

- Grommets available in standard table top locations (left, center or right). Order as: **AG1, AG2 or AG3** - Add \$69.
- Grommet hole dimensions are 3 1/4" wide x 1 7/8" deep.
- Grommets may be placed at non-standard locations. Order as: **AGS** - Add \$69. A drawing must be supplied with vertical and horizontal dimensions to the center of the cut-out (as in drawing below). Please refer to CUSTOM GROMMET LOCATION FORM in the back reference section.

Grommet hole dimensions:

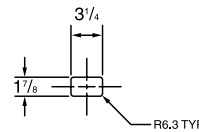

Grommet:

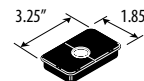

Grommet Locations:

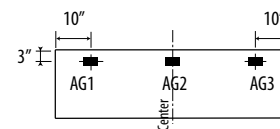

POWER BLOCK

- A power block (model **PMSPDM**) may be installed on all FreeFit tables
- The power block module includes one electrical duplex receptacle and two data (RJ45) receptacles. 9' Black cord with NEMA plug. Power block dimensions are 6.5"W x 3.5"D x 2.75"H.
- Power block cutout dimensions are 2.75"D x 6"W.
- Specify the power block cut-out location when ordering the table. The power block is ordered separately. Order power block separately as **PMSPDM**, Add \$261. Power blocks are available in standard worksurface locations (left, center or right). Specify **E1, E2 or E3 cutout location**. Add \$65.



Power Block **PMSPDM**. Add \$261



Specify location **E1, E2 or E3**. Add \$69

WORKSURFACES

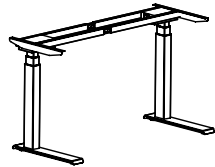
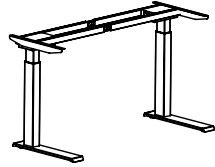
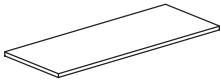

24" D Worksurfaces + Bases

MODEL#	DIMENSIONS	FREIGHT CLASS	WT/LBS.	CUBIC FT.	LIST PRICE	HP ADD
--------	------------	---------------	---------	-----------	------------	--------

D x W x H

24" D Rectangular Tops:

PHAT2370T	23 x 70 x 1	65	57	2	\$425	\$213
PHAT2364T	23 x 64 x 1	65	52	1.82	\$393	\$197
PHAT2358T	23 x 58 x 1	65	47	1.67	\$375	\$188
PHAT2352T	23 x 52 x 1	65	42	1.52	\$336	\$168
PHAT2346T	23 x 46 x 1	65	35	1.40	\$314	\$157
PHAT2340T	23 x 40 x 1	65	44	1.70	\$299	\$150
PHAT2334T	23 x 34 x 1	65	44	1.70	\$271	\$136

Standard Range Base:

FFHATS24	10 x -- x 26.8	60	45	1.40	\$1699	n/a
----------	----------------	----	----	------	---------------	-----

Extended Range Base:

FFHATE24	10 x -- x 26.8	60	45	1.40	\$1813	n/a
----------	----------------	----	----	------	---------------	-----

23" D tables feature feet at 21.75" D. Lifts 265 lbs. Each motor is mounted within the top of the column and will connect directly into one another without the need for a control box. **1" thick worksurfaces and electric height adjustable bases are specified separately.**

- Standard Range Tables can be paired with a Third Leg Kit to create "L" workstations. See FFHATRS on page 668.
- Extended Range Tables can be paired with a Third Leg Kit to create "L" workstations. See FFHATRE on page 668.
- **Recommended torque range for installing all fasteners is 3-5 foot pounds and should not be exceeded. In addition, no impact drivers or high-torque equipment are to be used for any fasteners included in the table assembly kits, as this creates a high risk for damage that is not covered under warranty. The use of hand tools is highly recommended.**

Required specifications

Top finish
Base finish
Foot style
Foot configuration

Optional specifications

HP laminate
Digital handset
Grommet
Insulation type

Accessories

Keyboard tray
Power block

WORKSURFACES

MODEL# DIMENSIONS FREIGHT CLASS WT/LBS. CUBIC FT. LIST PRICE HP ADD

D x W x H

30"D Rectangular Tops:

PHAT2970T	29 x 70 x 1	65	70	2.50	\$429	\$215
PHAT2964T	29 x 64 x 1	65	64	2.26	\$408	\$204
PHAT2958T	29 x 58 x 1	65	59	2.10	\$391	\$196
PHAT2952T	29 x 52 x 1	65	52	1.90	\$383	\$192
PHAT2946T	29 x 46 x 1	65	44	1.70	\$374	\$187
PHAT2940T	29 x 40 x 1	65	44	1.70	\$367	\$187
PHAT2934T	29 x 34 x 1	65	44	1.70	\$271	\$187

Standard Range Base:

FFHATS30	10 x -- x 26.8	60	45	1.40	\$1699	n/a
----------	----------------	----	----	------	---------------	-----

Extended Range Base:

FFHATE30	10 x -- x 26.8	60	45	1.40	\$1813	n/a
----------	----------------	----	----	------	---------------	-----

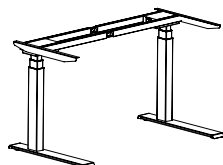
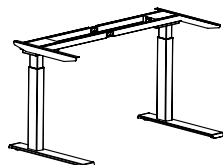

30"D Worksurfaces + Bases

29"D tables feature feet at 27.6"D. Lifts 265 lbs. Each motor is mounted within the top of the column and will connect directly into one another without the need for a control box. **1" thick worksurfaces and electric height adjustable bases are specified separately.**

- Standard Range Tables can be paired with a Third Leg Kit to create "L" workstations. See FFHATRS on page 668.
- Extended Range Tables can be paired with a Third Leg Kit to create "L" workstations. See FFHATRE on page 668.
- **Recommended torque range for installing all fasteners is 3-5 foot pounds and should not be exceeded. In addition, no impact drivers or high-torque equipment are to be used for any fasteners included in the table assembly kits, as this creates a high risk for damage that is not covered under warranty. The use of hand tools is highly recommended.**

Required specifications

Top finish
Base finish
Foot style
Foot configuration

Optional specifications

HP laminate
Digital handset
Grommet
Insulation type

Accessories

Keyboard tray
Power block

RETURNS

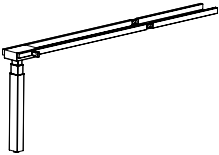
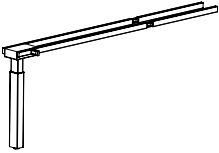

Third Leg Kit*

MODEL#	DIMENSIONS	FREIGHT CLASS	WT/LBS.	CUBIC FT.	LIST PRICE	HP ADD
--------	------------	---------------	---------	-----------	------------	--------

D x W x H

Return Tops:

PHAR2359T	23 x 59 x 1	65	45	1.90	\$370	\$185
PHAR2353T	23 x 53 x 1	60	102	2.20	\$336	\$168
PHAR2347T	23 x 47 x 1	60	94.5	2.10	\$314	\$157
PHAR2341T	23 x 41 x 1	65	40	1.60	\$299	\$150
PHAR2335T	23 x 35 x 1	65	34	1.40	\$271	\$136
PHAR2959T	29 x 59 x 1	65	57	2.30	\$446	\$223
PHAR2953T	29 x 53 x 1	60	112	2.40	\$383	\$192
PHAR2947T	29 x 47 x 1	60	104	2.30	\$374	\$187
PHAR2941T	29 x 41 x 1	65	40	1.70	\$370	\$185
PHAR2935T	29 x 35 x 1	65	34	1.50	\$370	\$185

Standard Range Third Leg Kit:

FFHATRS	10 x -- x 26.8	60	45	1.30	\$731	n/a
---------	----------------	----	----	------	--------------	-----

Extended Range Third Leg Kit:

FFHATRE	10 x -- x 26.8	60	45	1.30	\$773	n/a
---------	----------------	----	----	------	--------------	-----

Third leg kit to be used with FreeFit tables to create an electric height adjustable L station. Third leg kit includes a post and extended cross bar to support connection of the return surface to the main surface and mechanism. **1" thick worksurfaces and electric height adjustable bases are specified separately.**

- Standard range third leg kit must be paired with a standard range FreeFit base. See previous pages.
- Extended range third leg kit must be paired with an extended range FreeFit base. See previous pages.
- **Recommended torque range for installing all fasteners is 3-5 foot pounds and should not be exceeded. In addition, no impact drivers or high-torque equipment are to be used for any fasteners included in the table assembly kits, as this creates a high risk for damage that is not covered under warranty. The use of hand tools is highly recommended.**

Required specifications

Top finish*
Base finish*

Optional specifications

HP laminate*
Grommet*
Insulation type*

Accessories

Power block*

FELT DIVIDERS

MODEL#

DIMENSIONS

FREIGHT CLASS

WT./LBS.

CUBIC FT.

LIST PRICE

D x W x H

- 9mm thick panels offered in 9 finishes
- Made from 100% PET (polyester) fiber with a high content (50%) of post-recycled material, free of added chemicals, binders and adhesives
- Lightweight panels are tackable, impact and tear resistant, bacteria resistant, moisture resistant, and installation friendly
- Variation in fiber mix and color are inherent to the character of the product

FELT COLORS

BLK	Black	MTS	Mist
BRI	Brick	PWT	Pewter
DEN	Denim	SHR	Shamrock
GPH	Graphite	WHT	White
HVT	Harvest		

BRACKET FINISH

BLK	Black
DWT	Designer White
TUN	Tungsten

FELT DIVIDERS

MODEL#

DIMENSIONS

FREIGHT CLASS

WT./LBS.

CUBIC FT.

LIST PRICE

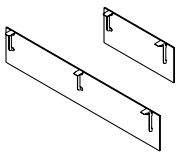

Modesty Felt Divider

BWAFMPS34	3.62 x 29.76 x 13.42	70	1.7	0.46	\$372
BWAFMPS40	3.62 x 35.76 x 13.42	250	2	0.56	\$386
BWAFMPS46	3.62 x 41.76 x 13.42	250	2.1	0.65	\$398
BWAFMPS52	3.62 x 47.76 x 13.42	250	2.3	0.74	\$411
BWAFMPS58	3.62 x 53.76 x 13.42	250	2.4	0.84	\$492
BWAFMPS64	3.62 x 59.76 x 13.42	250	3.1	0.93	\$649
BWAFMPS70	3.62 x 65.76 x 13.42	250	3.3	1.02	\$661

Connects parallel on Freefit tables. 9mm thick PET felt divider is tackable. Fastens to the underside of the worksurface. Installed divider measures 15" below top of the worksurface. 34" to 58" dividers include 2 brackets. 64" to 70" dividers include 3 brackets. Available in 9 PET felt colors. Please specify.

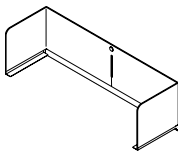

Felt Wrap Around Divider*

BWAFWR2346	18.46 x 46.84 x 18.24	65	26.58	1.07	\$431
BWAFWR2352	18.46 x 52.84 x 18.24	65	28.40	1.21	\$456
BWAFWR2358	18.46 x 58.84 x 18.24	65	30.22	1.34	\$481
BWAFWR2364	18.46 x 64.84 x 18.24	60	32.02	0.74	\$636
BWAFWR2370	18.46 x 70.84 x 18.24	60	33.84	0.81	\$678
BWAFWR2946	24.46 x 46.84 x 18.24	65	30.74	1.07	\$488
BWAFWR2952	24.46 x 52.84 x 18.24	60	32.55	0.60	\$643

End of Run:

BWAFWR2351	18.46 x 51.34 x 18.24	65	27.94	1.05	\$436
BWAFWR2951	24.46 x 51.34 x 18.24	60	32.09	0.62	\$642
BWAFWR2363	18.46 x 63.34 x 18.24	70	31.57	1.50	\$634
BWAFWR2963	24.46 x 63.34 x 18.24	60	35.73	0.87	\$726

Wraps around Freefit tables to provide privacy. 9mm thick PET felt divider is tackable. Fastens to the underside of the worksurface. Installed divider measures 15.7" from the top of the worksurface. Divider extends 1.5" past the back of the worksurface. Please choose standard base finish for the extrusion and brackets. PET is available in 9 felt colors. Please specify.

- Anodized Aluminum extrusion - Add **\$120** list upcharge

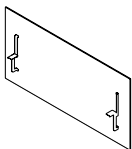

Felt Parallel Divider

BWAFP2246	6.45 x 33 x 21.5	250	2.62	0.94	\$376
BWAFP2252	6.45 x 39 x 21.5	250	2.85	1.12	\$392
BWAFP2258	6.45 x 45 x 21.5	250	3.08	1.29	\$406
BWAFP2264	6.45 x 51 x 21.5	250	3.31	1.46	\$433
BWAFP2270	6.45 x 57 x 21.5	250	4.22	1.63	\$589

Connects parallel on Freefit tables. 9mm thick PET felt divider is tackable. Fastens to the underside of the worksurface. 1.625" gap between worksurface and divider allows for cable pass-through. Installed divider measures 15.7" from the top of the worksurface and 5.75" below the worksurface. 34" to 58" dividers include 2 brackets. 64" to 70" dividers include 3 brackets. Available in 9 PET felt colors. Please specify.

Required Specifications

Felt color
Bracket finish

Optional Specifications

Anodized extrusion

TABLE MOUNTED DIVIDERS

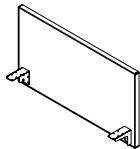

Table Mounted Framed Divider, Fabric*

MODEL#	DIMENSIONS D x W x H	FREIGHT CLASS	WT/LBS.	CUBIC FT.	LIST PRICE
BWATMFD48	1.25 x 33 x 21.5	85	16	1.23	\$316
BWATMFD54	1.25 x 39 x 21.5	85	18	1.46	\$391
BWATMFD60	1.25 x 45 x 21.5	85	20	1.68	\$428
BWATMFD66	1.25 x 51 x 21.5	85	22	1.90	\$480
BWATMFD72	1.25 x 57 x 21.5	85	26	2.13	\$525

Connects parallel on Freefit single and back-to-back tables. Fabric divider is tackable. Fastens to the underside of the worksurface. 1.625" gap between worksurface and divider allows for cable pass-through. Installed divider measures 15.7" from top of worksurface and 5.75" below the worksurface. 48" to 66" dividers include 2 support brackets. 72" divider includes 3 support brackets. Available in the following textiles:

- Global: **Anchorage, Lola, Brinx, Mariposa, Merge** and **Accent**
- Momentum: **Meander, Tracery and Universe (extended lead time).**

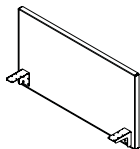

Table Mounted Framed Divider, Laminate**

MODEL#	DIMENSIONS D x W x H	FREIGHT CLASS	WT/LBS.	CUBIC FT.	LIST PRICE	HP ADD	DE ADD	DM ADD
BWATMLD48	1.25 x 33 x 21.5	85	35	1.23	\$208	\$117	\$275	\$420
BWATMLD54	1.25 x 39 x 21.5	85	39	1.46	\$235	\$151	\$344	\$531
BWATMLD60	1.25 x 45 x 21.5	85	44	1.68	\$278	\$159	\$362	\$565
BWATMLD66	1.25 x 51 x 21.5	85	48	1.90	\$321	\$220	\$757	\$1122
BWATMLD72	1.25 x 57 x 21.5	85	52	2.13	\$349	\$221	\$751	\$1115

Connects parallel on Freefit single and back-to-back tables. Divider infill can be specified in low pressure laminate (**LP**), high pressure laminate (**HP**), dry erase whiteboard (**DE**) or dry erase magnetic whiteboard (**DM**) user side only. Fastens to the underside of the worksurface. 1.625" gap between worksurface and divider allows for cable pass-through. Installed divider measures 15.7" from top of worksurface and 5.75" below the worksurface. 48" to 66" dividers include 2 support brackets. 72" divider includes 3 support brackets. When dry erase magnetic whiteboard (DM) is specified it is applied user side ONLY and dry erase whiteboard (DE) is applied on the opposite side.

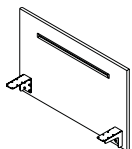

Table Mounted Laminate Divider**

BWATMLLD48	.75 x 33 x 21.5	125	16	1.23	\$249
BWATMLLD54	.75 x 39 x 21.5	125	18	1.46	\$264
BWATMLLD60	.75 x 45 x 21.5	125	20	1.68	\$279
BWATMLLD66	.75 x 51 x 21.5	125	22	1.90	\$414
BWATMLLD72	.75 x 57 x 21.5	125	26	2.13	\$427

Connects parallel on Freefit single and back-to-back tables. Laminate divider with integrated accessory rail, installed on one side only. Integrated anodized aluminum accessory rail, white cut out and rail trims; white power coat brackets. 3/4" LP PVC edged boards. Specify laminate and PVC edge. Fastens to the underside of the worksurface. 1.88" gap between worksurface and divider allows for cable pass-through. Installed divider measures 15.7" from top of worksurface and 5.75" below the worksurface. 48" to 66" dividers include 2 support brackets. 72" divider includes 3 support brackets.

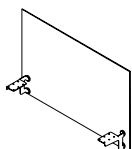

Table Mounted Glass Divider

BWATMGD48	.25 x 33 x 21.5	125	16	1.23	\$533
BWATMGD54	.25 x 39 x 21.5	125	19	1.46	\$574
BWATMGD60	.25 x 45 x 21.5	125	22	1.68	\$616
BWATMGD66	.25 x 51 x 21.5	125	24	1.90	\$652
BWATMGD72	.25 x 57 x 21.5	125	28	2.13	\$694

Frameless glass divider connects parallel on Freefit single and back-to-back tables. Tempered glass, acid etched on one side (similar to frosted), satin chrome disc fasteners and white powder coated steel support brackets. Fastens to the underside of the worksurface. 2.13" gap between worksurface and divider allows for cable pass-through. Installed divider measures 15.7" from top of worksurface and 4.75" below the worksurface. 48" to 66" dividers include 2 support brackets. 72" divider includes 3 support brackets. 1/2" radius on all four corners.

Required specifications

Laminate finish*
Bracket finish

WELLNESS SCREENS

MODEL# DIMENSIONS FREIGHT CLASS WT/LBS. CUBIC FT. LIST PRICE

D x W x H

FFTDP2436H24	31.75 x 34 x 24.6	125	26.55	3.94	\$831
FFTDP2442H24	31.75 x 40 x 24.6	125	28.10	4.59	\$857
FFTDP2448H24	31.75 x 46 x 24.6	150	29.65	5.25	\$881
FFTDP2454H24	31.75 x 52 x 24.6	150	31.20	5.94	\$907
FFTDP2460H24	31.75 x 58 x 24.6	150	32.75	6.56	\$932
FFTDP2466H24	31.75 x 64 x 24.6	150	34.30	7.22	\$956
FFTDP2472H24	31.75 x 70 x 24.6	150	35.85	7.88	\$982
FFTDP2478H24	31.75 x 76 x 24.6	150	37.40	8.53	\$1007
FFTDP2484H24	31.75 x 82 x 24.6	150	38.95	9.19	\$1033

FFTDP3036H24	37.75 x 34 x 24.6	100	40.50	4.72	\$890
FFTDP3042H24	37.75 x 40 x 24.6	125	42.05	5.51	\$916
FFTDP3048H24	37.75 x 46 x 24.6	125	43.60	6.29	\$941
FFTDP3054H24	37.75 x 52 x 24.6	125	45.15	7.08	\$967
FFTDP3060H24	37.75 x 58 x 24.6	150	46.70	7.85	\$991
FFTDP3066H24	37.75 x 64 x 24.6	150	48.25	8.65	\$1016
FFTDP3072H24	37.75 x 70 x 24.6	150	49.80	9.44	\$1042
FFTDP3078H24	37.75 x 76 x 24.6	150	51.35	10.22	\$1067
FFTDP3084H24	37.75 x 82 x 24.6	150	52.90	11.01	\$1092

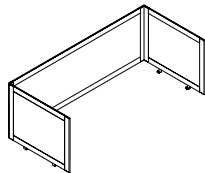

24" H Divider Screen

Powder coated aluminum frame, translucent ribbed polycarbonate. Includes all hardware to connect. Brackets are painted steel. Side dividers extend 7.25" from the front edge of each surface. Back divider extends over the back edge of the worksurface by 1.5", allowing for cable pass-through to trough. Width and depth are nominal sizes representing the sizes of the FreeFit table. Allow for .25" overhang at the sides, 1.5" at the back, and 7.25" at the front. Frame available in Black (BLK), Designer White (DWT) and Tungsten (TUN).

- **FFTDP24xxH24 are for configurations with 23" deep surfaces.**
- **FFTDP30xxH24 are for configurations with 29" deep surfaces.**

FFTDP2436H30	31.75 x 34 x 30.6	125	26.55	3.94	\$932
FFTDP2442H30	31.75 x 40 x 30.6	125	28.10	4.59	\$962
FFTDP2448H30	31.75 x 46 x 30.6	150	29.65	5.25	\$991
FFTDP2454H30	31.75 x 52 x 30.6	150	31.20	5.91	\$1019
FFTDP2460H30	31.75 x 58 x 30.6	150	32.75	6.56	\$1049
FFTDP2466H30	31.75 x 64 x 30.6	150	34.30	7.22	\$1077
FFTDP2472H30	31.75 x 70 x 30.6	150	35.85	7.88	\$1107
FFTDP2478H30	31.75 x 76 x 30.6	150	37.40	8.53	\$1135
FFTDP2484H30	31.75 x 82 x 30.6	150	38.95	9.19	\$1164

FFTDP3036H30	37.75 x 34 x 30.6	100	40.50	4.72	\$989
FFTDP3042H30	37.75 x 40 x 30.6	125	42.05	5.51	\$1019
FFTDP3048H30	37.75 x 46 x 30.6	125	43.60	6.29	\$1048
FFTDP3054H30	37.75 x 52 x 30.6	125	45.15	7.08	\$1075
FFTDP3060H30	37.75 x 58 x 30.6	150	46.70	7.87	\$1105
FFTDP3066H30	37.75 x 64 x 30.6	150	48.25	8.65	\$1134
FFTDP3072H30	37.75 x 70 x 30.6	150	49.80	9.44	\$1162
FFTDP3078H30	37.75 x 76 x 30.6	150	51.35	10.22	\$1192
FFTDP3084H30	37.75 x 82 x 30.6	150	52.90	11.01	\$1221

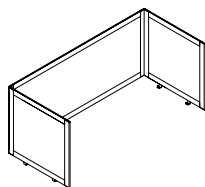

30" H Divider Screen

Powder coated aluminum frame, translucent ribbed polycarbonate. Includes all hardware to connect. Brackets are painted steel. Side dividers extend 7.25" from the front edge of each surface. Back divider extends over the back edge of the worksurface by 1.5", allowing for cable pass-through to trough. Width and depth are nominal sizes representing the sizes of the FreeFit table. Allow for .25" overhang at the sides, 1.5" at the back, and 7.25" at the front.

- **FFTDP24xxH30 are for configurations with 23" deep surfaces.**
- **FFTDP30xxH30 are for configurations with 29" deep surfaces.**

Required specifications

Frame finish

ACCESSORIES

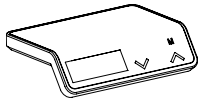

Digital Handset

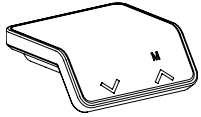

Standard Handset

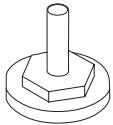

Extended Glide

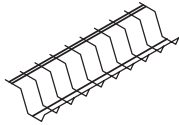

Wire Cable Tray

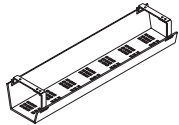

Flip Cable Tray

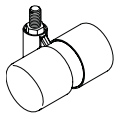

1.5" Dual Wheel Casters

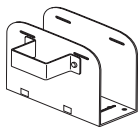

Leg Mounted CPU Holder*

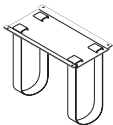

Strap Mounted CPU Holder

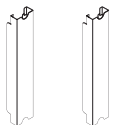

Cable Channel Leg**

MODEL#	DIMENSIONS D x W x H	FREIGHT CLASS	WT./LBS.	CUBIC FT.	LIST PRICE
FFDH	- x - x 1.5	70	.33	.01	\$284
Joggle Wheel Digital Handset with five programmable settings is optional when specifying each table base (Option DH), or may be ordered to upgrade handsets already installed. Silver finish only.					
FFSH	- x - x 1.5	70	.33	.01	\$78
Standard Handset with simple up/down buttons is standard on each table or may be ordered as replacements. Black finish only.					
FFGE	- x - x 1.5	70	.06	.01	\$20
Extended glides, increase adjustment range to 1.55" to 2" over standard adjustment from the standard 1.15" to 1.55".					
FFWCT18	- x - x 1.5	70	3.50	.22	\$29
Wire cable tray affixes to the underside of any surface with two screws. Includes all hardware to attach. Black finish only.					
FFCT2460	- x - x 1.5	250	3.50	1.20	\$216
FFCT3864	- x - x 1.5	150	6.25	1.20	\$234
Flip cable tray is installed under one crossbeam between the motor on a "C-Foot" base and is attached behind the last cross beam. Easily access cables by flipping the tray down. Includes all hardware to attach. Black finish only. • FFCT2460 expands from 14.75" to 26.95". • FFCT3864 expands from 26.75" to 50.35".					
FFCSTR4	- x - x 1.5	70	.35	.01	\$62
Includes two locking and two non-locking casters. Black finish only. • Adds 1.6" to the height of the table. • Cannot be used with Third Leg Kit					
FFCPUH	- x - x 1.5	92.5	4	.35	\$220
Bracket affixes the CPU holder to lower portion of any FreeFit Table leg. Supports width of 3.35" – 7.8". Available in Black (BLK), Designer White (DWT) and Tungsten (TUN).					
FFCPUS	- x - x 1.5	125	4	.35	\$155
Strap mounted CPU holder is attached to the underside of the surface with four screws. Includes all hardware. Black finish only. • Top plate is 5"W x 10"D.					
FFCLS21	- x - x 1.5	70	.09	.22	\$96
FFCLE18	- x - x 1.5	70	.75	.22	\$91
Affixes to the lower portion of FreeFit Table legs. Cannot be used in conjunction with FFCPUH . • FFCLS21 to be used with STANDARD RANGE tables. • FFCLE18 to be used with EXTENDED RANGE tables.					

Required specifications

CPU holder finish*
Cable channel finish**



Designed by Zoey Chu, **JUNCTION™** provides an affordable solution for your table applications. Choose from a variety of table top designs: Rectangular, Half Round, Trapezoid and Keystone to create a unique table for your boardroom, classroom or presentation room application.

A freestanding or shared leg configuration with the unique “Y” leg allows you to either create a permanent table or one that can be reconfigured quickly and easily. A Straight leg is available for use with half round and Keystone tops.

Shared leg configurations allow more legroom and can also decrease cost because they use fewer components. Freestanding configurations provide more flexibility for changing environments.



Features and Benefits

- Tops are 1” thick and constructed of 45 lb. density particleboard.
- Optional Radius Corners (RM) available at no upcharge.
- Optional modesty panel with integrated wire trough available.
- Casters available with or without manual locks provide mobility.
- Black grommets for convenient wire management can be ordered factory installed.
- Optional, easy-to-use thumbscrews allow installation without tools.
- JUNCTION™ tops are available in Global laminate finishes with 2 leg options.



Y Leg Design



Modesty Panel



Shared leg configuration provides more legroom and decreases the overall costs

GENERAL INFORMATION

- Junction is a series of multi-purpose tables for classroom, training room and boardroom applications
- Ability for tables to be set up as freestanding or shared leg configuration
- Unique design by Zooney Chu
- Half round, trapezoid and Keystone tops are available to create a variety of package configurations
- Rectangular tops are available in 20", 24" and 30" depths
- Optional modesty panels with integrated wire troughs are available
- Optional large electrical manager provides a safe environment for equipment wires
- Special width tops are available. Use next size up.
- Shipped R.T.A. (Ready to Assemble). Each component is packaged individually; Legs are shipped one per carton.
- Global laminate and seating products are in compliance with stringent emission guidelines set out by the Greenguard Environmental Institute under the standards for low emitting products and materials. www.greenguard.org
- **Level 2 Certified**

WORKSURFACES

- Tops are 1" thick, made of 45 lb. density particle board covered on both sides with high performance thermally fused laminate.
- Laminate finishes are available in High Pressure. Contact your Customer Service Representative for a quote.
- If other than a Global standard laminate finish is preferred, contact your Customer Service Representative. Information needed includes the name of the laminate manufacturer, color name, number and model of table. You will then be given a quote for this special order.
- Products specified with the high pressure laminate option are finished on the underside of the surface with a kraft paper backing.

CONSTRUCTION

- Rectangular tops 54" in length and longer include a steel support channel for structural rigidity
- Tops are pre-drilled with threaded steel inserts
- Special width tops are available. Use next size up.
- Tables adjust from 28 ¾" to 29 ¾" high.

EDGE DETAIL

- Tops are sealed with Global's preferred edge in matching color.
- Optional Radius Corners (**RM**) are available on rectangular tops at no upcharge.

LEGS

- Unique Y design
- Straight leg available for assembly with Half Round tops and Keystone tops
- Heavy duty steel construction
- Coated with environmentally friendly recycled paint that provides a durable finish
- Black plastic leveling glides offer 1" adjustability
- Available in **Black (BK)** or **Tungsten 2 (TU2)** finish
- Y Legs: 17½" leg span - 20"d Top, 21½" leg span - 24"d Top, 24½" leg span - 30"d Top.

CASTERS

- Optional casters are available
- 1½" Dual wheel casters with or without manual lock. Full 360° swivel
- Can be used in any combination with or without standard glides
- Suggested for carpeted surfaces
- Available in black only
- Sold in packages of two

GANGING

- Ganging plates are available for ganging workstations together
- Ganging plates are black epoxy coated steel plates with two thumbscrews
- Provides maximum stability and torque reduction

FLUSH PLATE

- Suggested for top clusters (fixed configurations for additional stability)
- Sold individually and shipped with two thumbscrews for mounting
- No tools required
- Flush plate allows for ganging together of two or more tops

WIRE MANAGEMENT

- Available for managing additional larger wires and power connectors
- 3½" high x 4¼" deep Black PVC channel attaches to the underside of top

1. SPECIFY MODEL NUMBER

2. SPECIFY FINISH

Laminate Finishes:

ACJ	Absolute Acajou
ASN	Asian Night
AWC	Avant Cherry
AWH	Avant Honey
BLK	Black
BRC	Brushed Cobalt
CMB	Clear Maple
DES	Dark Espresso
DWT	Designer White
HGT	Hayden Grey
QTM	Quartered Mahogany
SOG	Storm Grey
TFW	Tiger Fruitwood
TWL	Tiger Walnut
WHE	Walnut Heights
WHC	White Chocolate
WGY	Willow Grey
WCR	Winter Cherry

Legs:

TU2	Tungsten 2
BLK	Black

3. SPECIFY OPTIONS

Modesty Panels

- 11¼" high panel attaches to the underside of worksurface top
- Standard with integrated wire trough
- Available in black PVC

Grommets

- Grommets are available in **Rectangular and Trapezoid** Tops (left, center or right). See below for available locations. Order as: **AG1, AG2 or AG3. Add \$69.** For **Keystone** worksurface locations, order as **AG2. Add 69.**
- Grommet hole dimensions are 3 ¼" wide x 1 7/8" deep.

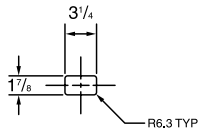

- Grommets may be placed at non-standard locations. Order as: **AGS - Add \$69.** A drawing must be supplied with vertical and horizontal dimensions to the center of the cut-out (as in drawing above). Please refer to CUSTOM GROMMET LOCATION FORM in the back reference section.

Power Block

- A Power Block (model **PMSPDM**) may be ordered on all worksurfaces.
- A Power Block is a rectangular worksurface power/data module with one electrical duplex receptacle and two data (RJ45) receptacles. 9' black cord included. Power Block dimensions are 3 ½" deep x 6 ½" wide x 2 ¾" high.
- To purchase a Power Block, you must specify both the Power Block cut-out location and the Power Block model #. Order Power Block as **PMSPDM, ADD \$261.** Power Blocks are available in standard worksurface locations (left, center or right). Order as **E1, E2 or E3. Add \$69.**



Power Block **PMSPDM, Add \$261**

EXAMPLES OF GROMMET AND POWER BLOCK POSITIONS

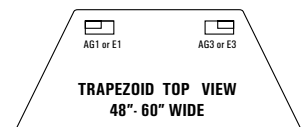
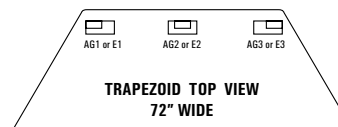
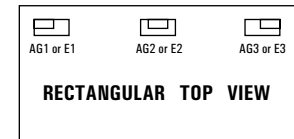
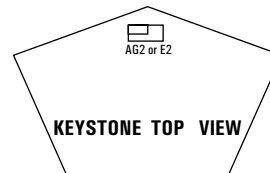

VILLA CUTOUTS

- Optional Villa cutout available in standard worksurface locations (left, center or right) for **Rectangular Tables.** Order as: **V1, V2 or V3. Add \$69 for each cutout.**
- Villa cutouts may be placed at non-standard locations. Please contact customer service.

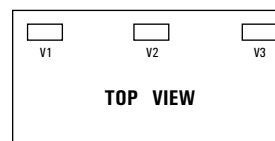

RECTANGULAR TOPS

MODEL# DIMENSIONS FREIGHT CLASS WT/LBS. CUBIC FT. LIST PRICE

D x W x H

JNR2042	20 x 42 x 1	65	26	1.10	\$270
JNR2048	20 x 48 x 1	65	29	1.15	\$302
JNRU2054	20 x 54 x 1	65	33	1.30	\$375
JNRU2060	20 x 60 x 1	65	37	1.40	\$403
JNRU2066	20 x 66 x 1	65	41	1.55	\$435
JNRU2072	20 x 72 x 1	65	45	1.66	\$464
JNR2442	24 x 42 x 1	65	31	1.25	\$270
JNR2448	24 x 48 x 1	65	35	1.40	\$302
JNRU2454	24 x 54 x 1	65	42	1.52	\$375
JNRU2460	24 x 60 x 1	65	47	1.67	\$403
JNRU2466	24 x 66 x 1	65	52	1.82	\$435
JNRU2472	24 x 72 x 1	65	57	2	\$464
JNR3042	30 x 42 x 1	65	38	1.51	\$328
JNR3048	30 x 48 x 1	65	44	1.70	\$346
JNRU3054	30 x 54 x 1	65	52	1.90	\$431
JNRU3060	30 x 60 x 1	65	59	2.10	\$462
JNRU3066	30 x 66 x 1	65	64	2.26	\$494
JNRU3072	30 x 72 x 1	65	70	2.50	\$527

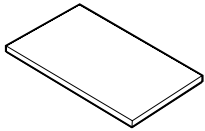

Rectangular Top

Pre-drilled with threaded steel inserts for freestanding and linking installations. **Tops 54" and longer are standard with a 16 gauge steel support channel.**

HALF ROUND TOPS

MODEL # DIMENSIONS FREIGHT CLASS WT/LB. CUBIC FT. LIST PRICE

JNHFS2040	20 x 40 x 1	70	23	1.05	\$286
JNHFS2048	20 x 48 x 1	65	27.50	1.15	\$296
JNHFS2448	24 x 48 x 1	65	34	1.40	\$319
JNHFS2454	27 x 54 x 1	65	38.25	1.52	\$377
JNHFS3060	30 x 60 x 1	60	53	1.67	\$414
JNHFS3066	33 x 66 x 1	60	58.30	1.82	\$517

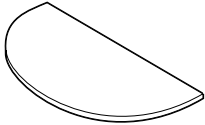

Half Round Top

Pre-drilled with threaded steel inserts for freestanding and linking installations. Four legs are required for freestanding configurations.

- **JNHFS2040/JNHFS2048** for use with 20" deep joining edge
- **JNHFS2448/JNHFS2454** for use with 24" deep joining edge
- **JNHFS3060/JNHFS3066** for use with 30" deep joining edge

TRAPEZOID TOPS

MODEL # DIMENSIONS FREIGHT CLASS WT/LB. CUBIC FT. LIST PRICE

JNTT2048	15.25 x 48 x 1	65	27.50	1.15	\$279
JNTT2060	15.25 x 60 x 1	65	34	1.40	\$333
JNTT2448	20.5 x 48 x 1	65	33	1.40	\$316
JNTT2460	20.5 x 60 x 1	65	41.25	1.67	\$381
JNTT3060	25.75 x 60 x 1	65	50.50	2.10	\$416
JNTT3072	25.75 x 72 x 1	65	61	2.50	\$464

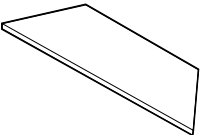

Trapezoid Top

Pre-drilled with threaded steel inserts for linking installations. **Not freestanding.**

- **JNTT2040/JNTT2048** for use with 20" deep joining edge
- **JNTT2448/JNTT2454** for use with 24" deep joining edge
- **JNTT3060/JNTT3066** for use with 30" deep joining edge

Required Specifications
Finish

Optional Specifications
Grommet

Accessories
Power Block

KEYSTONE TOPS **MODEL#** **DIMENSIONS** **FREIGHT CLASS** **WT/LB.** **CUBIC FT.** **LIST PRICE**

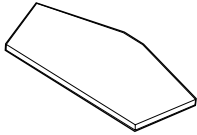

Keystone Top

	D x W x H					
JN5S2424	24 x 42 x 1	65	35	1.40		\$323
JN5S3030	30 x 54 x 1	65	53	2.10		\$414

Pre-drilled with threaded steel inserts for linking installations. **Not freestanding**

- **JN5S2424** for use with 20" deep joining edge
- **JN5S3030** for use with 24" deep joining edge

MODESTY PANELS **MODEL#** **DIMENSIONS** **FREIGHT CLASS** **WT/LB.** **CUBIC FT.** **LIST PRICE**

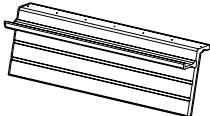

Modesty Panel

JNMP42	6.92 x 29.19 x 11.25	250	3.70	1.50		\$223
JNMP48	6.92 x 35.19 x 11.25	250	4.50	1.75		\$251
JNMP54	6.92 x 41.19 x 11.25	250	5	2		\$280
JNMP60	6.92 x 47.19 x 11.25	250	5.90	2.25		\$308
JNMP66	6.92 x 53.19 x 11.25	250	6.60	2.50		\$330
JNMP72	6.92 x 59.19 x 11.25	250	7.40	2.75		\$359

For use with **JNR rectangular tops**. 11 ¼" high, Black plastic, attractive ribbed design. Includes integrated wire trough. Connects to predrilled holes in table top.



Modesty Panel

JNMTT2048	6.92 x 22.75 x 11.25	250	2.80	1.17		\$197
JNMTT2060	6.92 x 34.75 x 11.25	250	4.30	1.70		\$222
JNMTT2448	6.92 x 19 x 11.25	250	2.50	1		\$197
JNMTT2460	6.92 x 31 x 11.25	250	3.90	1.55		\$222
JNMTT3060	6.92 x 26 x 11.25	250	3.30	1.30		\$197
JNMTT3072	6.92 x 38 x 11.35	250	4.70	1.90		\$222

For use with **JNTT trapezoid tops**. 11 ¼" high, Black plastic, attractive ribbed design. Includes integrated wire trough. Connects to predrilled holes in table top.

WIRE MANAGEMENT **MODEL #** **DIMENSIONS** **FREIGHT CLASS** **WT/LB.** **CUBIC FT.** **LIST PRICE**



Wire Manager

JNEC5S	4.14 x 12.5 x 3.63	70	1	.10		\$58
--------	--------------------	----	---	-----	--	-------------

For use with **JN5S Keystone Tops**. For managing additional wires and power connectors. 3/8"H Black PVC channel connects to predrilled holes in table top.



Wire Manager

JNEC42	4.14 x 41.75 x 3.63	125	2.52	.33		\$141
JNEC48	4.14 x 47.75 x 3.63	125	2.88	.38		\$164
JNEC54	4.14 x 53.75 x 3.63	125	3.24	.43		\$186
JNEC60	4.14 x 59.75 x 3.63	125	3.60	.48		\$206
JNEC66	4.14 x 65.75 x 3.63	125	3.96	.53		\$216
JNEC72	4.14 x 71.75 x 3.63	125	4.32	.58		\$280

For use with **JNR Rectangular Tops**. For managing additional wires and power connectors. 3/8"H Black PVC channel connects to predrilled holes in the table top.

Required Specifications
Finish

Optional Specifications
Grommet

Accessories
Power Block

WIRE MANAGER



Wire Manager

MODEL#	DIMENSIONS D x W x H	FREIGHT CLASS	WT./LBS.	CUBIC FT.	LIST PRICE
JNECT2048	4.14 x 28.75 x 3.63	70	1.74	.23	\$141
JNECT2060	4.14 x 40.75 x 3.63	125	2.46	.33	\$197
JNECT2448	4.14 x 24.75 x 3.63	70	1.50	.20	\$141
JNECT2460	4.14 x 36.75 x 3.63	125	2.22	.30	\$197
JNECT3060	4.14 x 31.75 x 3.63	70	1.92	.25	\$141
JNECT3072	4.14 x 43.75 x 3.63	125	2.64	.35	\$197

For use with **JNTT Trapezoid Tops**. For managing additional wires and power connectors. 3/4" high Black PVC channel connects to predrilled holes in the table top.

LEGS

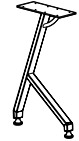

"Y" Leg

MODEL#	DIMENSIONS	FREIGHT CLASS	WT./LB.	CUBIC FT.	LIST PRICE
GJNLEG20	17.25 x 2 x 27.5	150	8.50	2	\$214

Leg span is 17½". Leveling glides are standard. **For assembly with 20" deep tops**

- List Price is per each leg.
- Available in Black (BK) or Tungsten 2 (TU2)

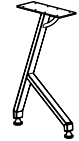

"Y" Leg

GJNLEG24	21.5 x 2 x 27.5	150	10	2.50	\$214
----------	-----------------	-----	----	------	--------------

Leg span is 21½". Leveling glides are standard. **For assembly with 24" deep tops**

- List Price is per each leg.
- Available in Black (BK) or Tungsten 2 (TU2)

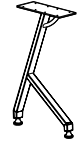

"Y" Leg

GJNLEG30	24.5 x 2 x 27.5	250	11	2.85	\$231
----------	-----------------	-----	----	------	--------------

Leg span is 24½". Leveling glides are standard. **For assembly with 30" deep tops**

- List Price is per each leg.
- Available in Black (BK) or Tungsten 2 (TU2)

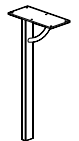

Straight Leg

JNLEG	1 x 2 x 27.5	150	6	1.30	\$189
-------	--------------	-----	---	------	--------------

Leveling glides are standard. **For assembly with half round and keystone tops**. Mounting plate is 11" deep by 5" wide.

- List Price is per each leg.
- Available in Black (BK) or Tungsten 2 (TU2)

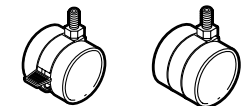

Casters

JNCP	--	--	--	--	\$44
------	----	----	----	----	-------------

Set of (2) 1½" dual wheel casters, one locking. Suggested for carpeted surfaces. Casters are fully interchangeable with glides. Black only.

- For use with Junction units only
- Casters DO NOT affect table height

Required Specifications

Finish

Optional Specifications

Grommet (Keystone)

Accessories

Power Block (Keystone)

ACCESSORIES

MODEL# DIMENSIONS FREIGHT CLASS WT/LBS. CUBIC FT. LIST PRICE

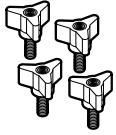

Thumbscrews

	D x W x H				
JNTS	--	--	--	--	\$25

Triangular thumbscrew with 3/4" steel thread. Set of 4. Can be used in place of factory supplied screws to allow installation of "Y" legs to tops without tools. Black only.

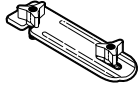

Ganging Flush Plate

JNGFP	--	--	--	--	\$47
-------	----	----	----	----	-------------

Black epoxy coated steel plates with 2 thumbscrews included. Used to connect table tops together for additional stability or for connecting freestanding tops together. Holes with steel inserts are located in the corner of the tops to accommodate this plate. Sold individually.

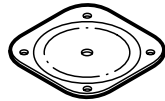

Flush Plate

JNFP1	5.25 d x 5.25 w	--	--	--	\$25
JNFP4	5.25 d x 5.25 w	--	--	--	\$96

Assures alignment on adjoining worksurfaces of the same height. Bolts included. Available in Black only.
JNFP1 - 1 per carton.
JNFP4 - 4 per carton.

Required Specifications

Finish



Kadin adds modern flair to your meeting space. From formal conference rooms to intimate meeting spaces or open forums, Kadin fits wherever people meet. Choose from round, square or rectangular tops in a variety of sizes with multiple edge options. Table depths start at 36", available widths are almost limitless. Surfaces are offered in architectural grade veneer and high-pressure laminate. The beautifully sculpted leg support maximizes leg clearance to keep guests comfortable. Extending from the leg support, the beam structure and connectors create visual interest as people come together. Pre-configured base assemblies make it easy to specify.



Features and Benefits

- Constructed of 45lb. density particleboard with high pressure laminate or grade A veneers
- 3 top shapes
- Solid die-cast aluminum leg with adjustable glide
- 5 edge options
- Metal bases available in 8 finishes
- Beam available in 7 finishes to match leg



90° connector



60° connector (for three leg tables only)



Beam construction

GENERAL INFORMATION

- Laminate or Veneer tops with multiple edge options
- Three top shapes - round, square, rectangular
- Pre-configured assemblies make specifying easy
- Kadin pairs perfectly with storage from a number of Global desking series
- Global laminate and seating products are in compliance with stringent emission guidelines set out by the Greenguard Environmental Institute under the standards for low emitting products and materials. www.greenguard.org
- Level 3 Certified

**TABLES WITH LAMINATE TOPS:
CONSTRUCTION**

- Constructed of 45 lb. density particleboard with high pressure laminate
- Tables are pre-drilled with factory installed inserts for easy metal-to-metal base connection
- Solid die-cast aluminum leg with adjustable glide

WORKSURFACES

- Available in 1-1/16" or 1-7/16" high pressure laminate tops with a 3mm PVC edge or 1-3/16" high pressure laminate top with a 3mm PVC edge trim
- Laminate surfaces offer a selection of matching + coordinating edge band, specify separately from the surface finish
- Tables up to and including 96" long are manufactured in one piece, 108" to 168" long are manufactured in two pieces, and over 192" are manufactured in three pieces. If woodgrain laminate is chosen, the woodgrain pattern may not line up.
- Tables in two or three pieces will have the joining edge finished; hardware will be shipped for assembly
- Products specified with the high pressure laminate option are finished on the underside of the surface with a kraft paper backing.

EDGES

- Tables with **B** Edge are 1-1/16" thick and have a 3mm PVC edge
- Tables with a **W** Edge are 1-7/16" thick and have a 3mm PVC edge
- Tables with a **KL** edge are 1-3/16" thick with a 3mm PVC edge and a 2" undercut knife profile
- Square and Rectangular Tables with a **B** or **W** edge have a 1" radius at each corner. For 90° corners, please add **NR** at the end of the product code. No upcharge.
- Square and Rectangular tables with a **KL** edge have 90° corners. There is no radius corner option for the KL edge.

**TABLES WITH VENEER TOPS:
CONSTRUCTION**

- Constructed of 45 lb. density particleboard with grade A veneers
- Tables are pre-drilled with factory installed inserts for easy metal-to-metal base connection
- Solid die-cast aluminum leg with adjustable glide

WORKSURFACES

- 1-3/16" thick veneer tops with choice of edge.
- Tables up to and including 96" long are manufactured in one piece, 108" to 168" long are manufactured in two pieces, and over 192" are manufactured in three pieces.
- Veneer wood grain will run with the **length** of the table and align at the seam up to 168"
- Veneer wood grain will run with the **depth** of the table (i.e. cross grain) on tables 192" and up.
- Caramel Bamboo (BAMC) will not align at the seam on any size surface
- Tables in two or three pieces will have the joining edge finished; hardware will be shipped for assembly

EDGES

- Tables with a **KF** edge are 1-3/16" thick with a flat 3mm hardwood edge, stained to match to veneer.
- Tables with a **KV** edge are 1-3/16" thick with a flat 3mm hardwood edge and 2" undercut knife edge profile.
- Square and Rectangular Tables with the **KF** and **KV** edge have 90° corners. There is no radius corner option.

GROMMETS

- Grommets available in standard table top locations (left, center or right). Order as: **AG1, AG2 or AG3. Add \$69**
- Grommet hole dimensions are 3 1/4" wide x 1 7/8" deep.



- Actual grommet locations will vary according to base selection.

WIRE MANAGEMENT

- For vertical and horizontal wire management, please refer to wire management section below, or Productivity Solutions on page 487.

CUT-OUTS FOR POWER BLOCKS

- Optional cut-out available in standard worksurface locations (left, center or right) for all table shapes. **Add \$69 for each cut-out.**
- Cut-outs may be placed at non-standard locations. Please contact customer care.
- Match power block desired with cut-out code and location from above grid
- Power module cut-out locations are not available on all models – please see diagrams to the right for restrictions.

*Oasis Mini is not available on 36"D models due to space restrictions caused by beam placement.

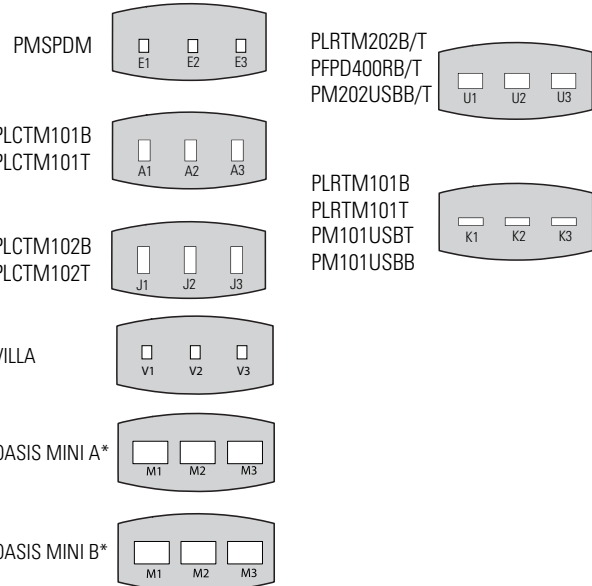

1. SPECIFY MODEL NUMBER

2. SPECIFY FINISH

LAMINATE FINISHES

ACJ	Absolute Acajou	HGT	Hayden Grey
ASN	Asian Night	QTM	Quartered Mahogany
AWC	Avant Cherry	SOG	Storm Grey
AWH	Avant Honey	TFW	Tiger Fruitwood
BLK	Black	TWL	Tiger Walnut
BRC	Brushed Cobalt	WHE	Walnut Heights
CMB	Clear Maple	WHC	White Chocolate
DES	Dark Espresso	WCR	Winter Cherry
DWT	Designer White		

BEAM FINISHES

BLK	Black	CHR	Charcoal
DWT	Designer White	NEV	Nevada
SIL	Silver	TPE	Taupe
TUN	Tungsten		

VENEER FINISHES:

Code	Finish	Veneer Type	Cut
AMW	Almond Cherry	Cherry	Flat Sliced
BAMC	Caramel Bamboo	Bamboo	Narrow
CAW	Cocoa Walnut	Walnut	Flat Sliced
CRW	Coral	White Oak	Rift
DCW	Dark Cherry	Cherry	Flat Sliced
EWV	Espresso Walnut	Walnut	Flat Sliced
EVW	Evening Oak	White Oak	Rift
GRW	Grey on Oak	White Oak	Rift
HAW	Hazelnut	Maple	Flat Sliced
SMW	Honey Maple	Maple	Flat Sliced
JAW	Java	White Oak	Rift
LTW	Latte Walnut	Walnut	Flat Sliced
MTW	Milestone	White Oak	Rift
MCW	Mocha	White Oak	Rift
MPW	Natural Maple	Maple	Flat Sliced
RCW	Red Cherry	Cherry	Flat Sliced
VNW	Vintage Cherry	Cherry	Flat Sliced
WLW	Walnut	Walnut	Flat Sliced
WCW	Warm Cherry	Cherry	Flat Sliced
WMW	White Maple	Maple	Flat Sliced

EDGE FINISHES (Laminate Surfaces Only)

AAE	Absolute Acajou	DWE	Designer White
ASE	Asian Night	QTM	Quartered Mahogany
ACE	Avant Cherry	TPE	Taupe (<i>use w/HGT</i>)
AHE	Avant Honey	TFE	Tiger Fruitwood
BLK	Black	TWE	Tiger Walnut
BRC	Brushed Cobalt	WHE	Walnut Heights
CHR	Charcoal (<i>use w/SOG</i>)	CBE	White Chocolate
CME	Clear Maple	WCE	Winter Cherry
DEE	Dark Espresso		

LEG FINISHES

CHM	Chrome	BLK	Black
CHR	Charcoal	DWT	Designer White
NEV	Nevada	SIL	Silver
TPE	Taupe	TUN	Tungsten

3. SPECIFY OPTIONS

Edge Options:

"B" Edges

Laminate surface with PVC edge

HP (B) 1-1/16" Thickness



"W" Edges

Laminate surface with PVC edge

HP (W) 1-7/16" Thickness



"KL" Edges

Laminate surface with PVC edge

HP (KL) 1-3/16" Thickness

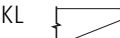

"KF" Edges

Veneer surface with Hardwood edge

(KF) 1-3/16" Thickness



"KV" Edges

Veneer surface with Hardwood edge

(KV) 1-3/16" Thickness

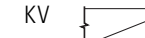

CUT-OUT LOCATIONS:

Square Table - position 2 only

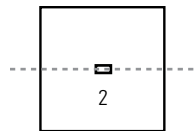

Round Table - position 2 only

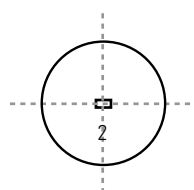

Rectangular Table

- Cut-out only in position 2: LKD3648, LKD3654, LKD4248, LKD4254, LKD4854
- One cut-out choice only (position 1, 2 or 3): LKD3660, LKD3666, LKD3672, LKD4260, LKD4266, LKD4272
- Up to 3 cut-outs in position 1, 2 and/or 3: LKD3678, LKD3684, LKD3696, LKD4278, LKD4284, LKD4296, LKD4878, LKD4884, LKD4896

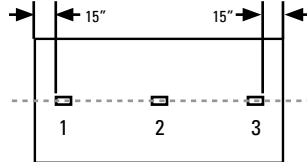

Rectangular Table - 2 piece top

- Up to 2 cut-outs in position 1 and/or 3 - all sizes

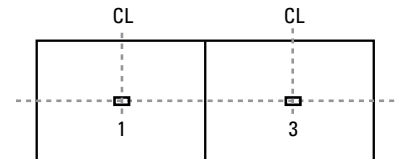

Rectangular Table - 3 piece top

- Up to 3 cut-outs in position 1, 2 and/or 3 - all sizes

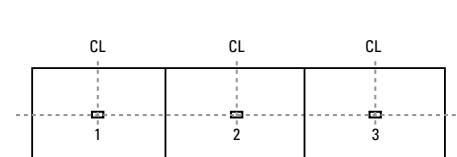

Note: Grommet orientation follows the length of table.

SQUARE TABLES - LAMINATE **MODEL#** **DIMENSIONS** **FREIGHT CLASS** **WT/LBS.** **CUBIC FT.** **B-EDGE** **W-EDGE** **KL-EDGE**

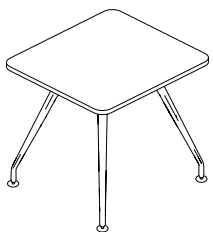

Square Table - Laminate Top*

	D x W x H							
LKD3636	36 x 36 x 29-29.5	100	73	4	\$1346	\$1510	\$1565	
LKD4242	42 x 42 x 29-29.5	100	86	4	\$1537	\$1694	\$1827	
LKD4848	48 x 48 x 29-29.5	92.5	107	5	\$1805	\$1996	\$2126	
LKD5454	54 x 54 x 29-29.5	85	120	5	\$1988	\$2221	\$2555	
LKD6060	60 x 60 x 29-29.5	92.5	135	6	\$2191	\$2469	\$2928	

Tops feature 3mm pvc edge and metal inserts for ease of assembly to base. Also includes four legs, four 90-degree connectors and four leg beams.

SQUARE TABLES - VENEER **KF EDGE** **KV EDGE**

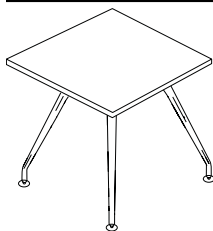

Square Table - Veneer Top

LKD3636K	36 x 36 x 29-29.5	100	73	4	\$1783	\$1848	
LKD4242K	42 x 42 x 29-29.5	92.5	86	4	\$2124	\$2212	
LKD4848K	48 x 48 x 29-29.5	92.5	107	5	\$2516	\$2630	
LKD5454K	54 x 54 x 29-29.5	85	120	5	\$3048	\$3192	
LKD6060K	60 x 60 x 29-29.5	92.5	135	6	\$3538	\$3716	

Tops feature hardwood edge and metal inserts for ease of assembly to base. Also includes four legs, four 90-degree connectors and four leg beams.

ROUND TABLES - LAMINATE **B-EDGE** **W-EDGE** **KL-EDGE**

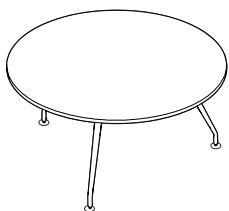

Round Table - 3 Legs*

LKD36DIA	36 x 36 x 29-29.5	92.5	66	3	\$1085	\$1255	\$1348
LKD42DIA	42 x 42 x 29-29.5	85	78	3	\$1278	\$1436	\$1604
LKD48DIA	48 x 48 x 29-29.5	85	99	4	\$1517	\$1715	\$1896
LKD54DIA	54 x 54 x 29-29.5	85	111	4	\$1700	\$1938	\$2295
LKD60DIA	60 x 60 x 29-29.5	85	126	5	\$1900	\$2186	\$2662

Tops feature 3mm pvc edge and metal inserts for ease of assembly to base. Also includes three legs, three 60-degree connectors and three leg beams.



Round Table - 4 Legs*

LKD436DIA	36 x 36 x 29-29.5	100	66	3	\$1346	\$1510	\$1565
LKD442DIA	42 x 42 x 29-29.5	92.5	78	3	\$1537	\$1694	\$1826
LKD448DIA	48 x 48 x 29-29.5	92.5	99	4	\$1805	\$1996	\$2125
LKD454DIA	54 x 54 x 29-29.5	85	111	4	\$1988	\$2221	\$2552
LKD460DIA	60 x 60 x 29-29.5	92.5	126	5	\$2191	\$2468	\$2925

Tops feature 3mm pvc edge and metal inserts for ease of assembly to base. Also includes four legs, four 90-degree connectors and four leg beams.

Required Specifications

- Top Finish
- Leg Finish
- Edge Finish*
- Edge Style

Optional Specifications

- Grommet

Accessories

- Power Block

ROUND TABLES - VENEER

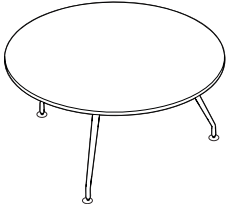

Round Table - 3 Legs

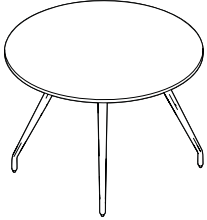

Round Table - 4 Legs

MODEL# DIMENSIONS FREIGHT CLASS WT./LBS. CUBIC FT. KF EDGE KV EDGE

D x W x H

LKD36DIAK	36 x 36 x 29-29.5	92.5	66	3	\$1567	\$1632
LKD42DIAK	42 x 42 x 29-29.5	85	78	3	\$1901	\$1989
LKD48DIAK	48 x 48 x 29-29.5	85	99	4	\$2285	\$2399
LKD54DIAK	54 x 54 x 29-29.5	85	111	4	\$2788	\$2933
LKD60DIAK	60 x 60 x 29-29.5	85	126	5	\$3270	\$3448

Tops feature hardwood edge and metal inserts for ease of assembly to base. Also includes three legs, three 60-degree connectors and three leg beams.

LKD436DIAK	36 x 36 x 29-29.5	100	66	3	\$1783	\$1848
LKD442DIAK	42 x 42 x 29-29.5	92.5	78	3	\$2124	\$2212
LKD448DIAK	48 x 48 x 29-29.5	92.5	99	4	\$2516	\$2630
LKD454DIAK	54 x 54 x 29-29.5	85	111	4	\$3048	\$3192
LKD460DIAK	60 x 60 x 29-29.5	92.5	126	5	\$3538	\$3716

Tops feature hardwood edge and metal inserts for ease of assembly to base. Also includes four legs, four 90-degree connectors and four leg beams.

RECTANGULAR TABLES - LAMINATE

B-EDGE W-EDGE KL-EDGE

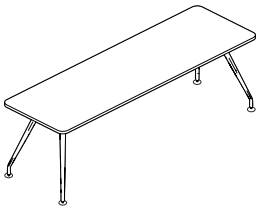

Rectangular Table*

LKD3648	36 x 48 x 29-29.5	100	75	4	\$1592	\$1761	\$1809
LKD3654	36 x 54 x 29-29.5	92.5	81	4	\$1661	\$1849	\$1977
LKD3660	36 x 60 x 29-29.5	100	88	5	\$1733	\$1938	\$2099
LKD3666	36 x 66 x 29-29.5	100	95	5	\$1805	\$2029	\$2220
LKD3672	36 x 72 x 29-29.5	92.5	101	5	\$1874	\$2114	\$2340
LKD3678	36 x 78 x 29-29.5	92.5	105	5	\$1945	\$2203	\$2462
LKD3684	36 x 84 x 29-29.5	92.5	108	5	\$2017	\$2294	\$2583
LKD3696	36 x 96 x 29-29.5	100	115	6	\$2159	\$2472	\$2825
LKD4248	42 x 48 x 29-29.5	92.5	87	4	\$1706	\$1872	\$1967
LKD4254	42 x 54 x 29-29.5	100	90	5	\$1790	\$1974	\$2154
LKD4260	42 x 60 x 29-29.5	100	94	5	\$1873	\$2071	\$2294
LKD4266	42 x 66 x 29-29.5	92.5	101	5	\$1956	\$2173	\$2433
LKD4272	42 x 72 x 29-29.5	92.5	106	5	\$2041	\$2272	\$2575
LKD4278	42 x 78 x 29-29.5	100	110	6	\$2123	\$2373	\$2714
LKD4284	42 x 84 x 29-29.5	100	113	6	\$2208	\$2474	\$2854
LKD4296	42 x 96 x 29-29.5	92.5	129	6	\$2375	\$2674	\$3135
LKD4854	48 x 54 x 29-29.5	100	94	5	\$1942	\$2144	\$2331
LKD4860	48 x 60 x 29-29.5	100	99	5	\$2035	\$2258	\$2490
LKD4866	48 x 66 x 29-29.5	100	107	6	\$2128	\$2366	\$2648
LKD4872	48 x 72 x 29-29.5	100	114	6	\$2222	\$2479	\$2808
LKD4878	48 x 78 x 29-29.5	92.5	120	6	\$2314	\$2593	\$2966
LKD4884	48 x 84 x 29-29.5	92.5	125	6	\$2409	\$2704	\$3125
LKD4896	48 x 96 x 29-29.5	92.5	149	7	\$2594	\$2926	\$3442

Tops feature 3mm pvc edge and metal inserts for ease of assembly to base. Also includes four legs, four 90-degree connectors and four leg beams.

Required Specifications

Top Finish
Leg Finish
Edge Finish*
Edge Style

Optional Specifications

Grommet

Accessories

Power Block

RECTANGULAR TABLES - LAMINATE

MODEL# DIMENSIONS FREIGHT CLASS WT/LBS. CUBIC FT. B-EDGE W-EDGE KL-EDGE

D x W x H

LKD36108	36 x 108 x 29-29.5	92.5	154	7	\$2969	\$3201	\$3557
LKD36120	36 x 120 x 29-29.5	125	164	8	\$3121	\$3379	\$3798
LKD42108	42 x 108 x 29-29.5	150	124	8	\$3167	\$3431	\$3905
LKD42120	42 x 120 x 29-29.5	150	141	9	\$3336	\$3624	\$4186
LKD48108	48 x 108 x 29-29.5	150	127	9	\$3407	\$3693	\$4256
LKD48120	48 x 120 x 29-29.5	150	151	9	\$3599	\$3918	\$4573
LKD48132	48 x 132 x 29-29.5	150	164	10	\$3784	\$4133	\$4890
LKD48144	48 x 144 x 29-29.5	125	181	10	\$3833	\$4188	\$5208
LKD48156	48 x 156 x 29-29.5	150	191	11	\$4158	\$4564	\$5526
LKD48168	48 x 168 x 29-29.5	125	206	11	\$4343	\$4774	\$5843
LKD48180	48 x 180 x 29-29.5	125	220	12	\$4667	\$5150	\$6159
LKD54144	54 x 144 x 29-29.5	150	193	11	\$4282	\$4692	\$5716
LKD54168	54 x 168 x 29-29.5	150	214	12	\$4693	\$5163	\$6426
LKD60144	60 x 144 x 29-29.5	150	206	12	\$4535	\$4980	\$6179
LKD60168	60 x 168 x 29-29.5	150	227	13	\$4983	\$5495	\$6963

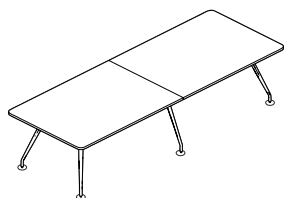

Rectangular Table - 2 piece top

Tops feature 3mm pvc edge and metal inserts for ease of assembly to base. Also includes six legs, four 90-degree connectors, two 3-way connectors and four leg beams.

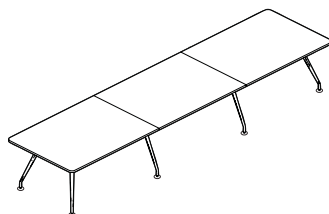

Rectangular Table - 3 piece top

LKD48192	48 x 192 x 29-29.5	150	279	14	\$5251	\$5739	\$6972
LKD54192	54 x 192 x 29-29.5	150	288	15	\$5644	\$6177	\$7635
LKD54216	54 x 216 x 29-29.5	150	270	16	\$6053	\$6650	\$8344
LKD54240	54 x 240 x 29-29.5	150	298	17	\$6464	\$7124	\$9055
LKD60192	60 x 192 x 29-29.5	150	257	16	\$5978	\$6556	\$8251
LKD60216	60 x 216 x 29-29.5	150	283	17	\$6427	\$7073	\$9036
LKD60240	60 x 240 x 29-29.5	150	311	18	\$6875	\$7588	\$9819

Tops feature 3mm pvc edge and metal inserts for ease of assembly to base. Also includes eight legs, four 90-degree connectors, four 3-way connectors and eight leg beams.

Required Specifications

Top Finish
Leg Finish
Edge Finish
Edge Style

Optional Specifications

Grommet

Accessories

Power Block

RECTANGULAR TABLES - VENEER

MODEL# DIMENSIONS FREIGHT CLASS WT/LBS. CUBIC FT. KF EDGE KV EDGE

D x W x H

LKD3648K	36 x 48 x 29-29.5	100	75	4	\$2101	\$2186
LKD3654K	36 x 54 x 29-29.5	92.5	81	4	\$2305	\$2401
LKD3660K	36 x 60 x 29-29.5	100	88	5	\$2463	\$2570
LKD3666K	36 x 66 x 29-29.5	100	95	5	\$2620	\$2738
LKD3672K	36 x 72 x 29-29.5	92.5	101	5	\$2778	\$2905
LKD3678K	36 x 78 x 29-29.5	92.5	105	5	\$2936	\$3076
LKD3684K	36 x 84 x 29-29.5	92.5	108	5	\$3094	\$3244
LKD3696K	36 x 96 x 29-29.5	100	115	6	\$3410	\$3581
LKD4248K	42 x 48 x 29-29.5	92.5	87	4	\$2308	\$2407
LKD4254K	42 x 54 x 29-29.5	100	90	5	\$2537	\$2650
LKD4260K	42 x 60 x 29-29.5	100	94	5	\$2720	\$2844
LKD4266K	42 x 66 x 29-29.5	92.5	101	5	\$2902	\$3039
LKD4272K	42 x 72 x 29-29.5	92.5	106	5	\$3085	\$3235
LKD4278K	42 x 78 x 29-29.5	100	110	6	\$3268	\$3429
LKD4284K	42 x 84 x 29-29.5	100	113	6	\$3450	\$3625
LKD4296K	42 x 96 x 29-29.5	92.5	129	6	\$3816	\$4014
LKD4854K	48 x 54 x 29-29.5	100	94	5	\$2769	\$2898
LKD4860K	48 x 60 x 29-29.5	100	99	5	\$2976	\$3119
LKD4866K	48 x 66 x 29-29.5	100	107	6	\$3183	\$3340
LKD4872K	48 x 72 x 29-29.5	100	114	6	\$3391	\$3562
LKD4878K	48 x 78 x 29-29.5	92.5	120	6	\$3598	\$3784
LKD4884K	48 x 84 x 29-29.5	92.5	125	6	\$3806	\$4005
LKD4896K	48 x 96 x 29-29.5	92.5	149	7	\$4220	\$4448

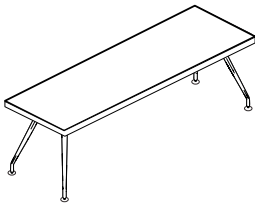

Rectangular Table

Tops feature hardwood edge and metal inserts for ease of assembly to base. Also includes four legs, four 90-degree connectors and four leg beams.

LKD36108K	36 x 108 x 29-29.5	125	154	7	\$4213	\$4405
LKD36120K	36 x 120 x 29-29.5	125	164	8	\$4528	\$4741
LKD42108K	42 x 108 x 29-29.5	150	124	8	\$4673	\$4897
LKD42120K	42 x 120 x 29-29.5	150	141	9	\$5037	\$5286
LKD48108K	48 x 108 x 29-29.5	150	127	9	\$5132	\$5387
LKD48120K	48 x 120 x 29-29.5	150	151	9	\$5547	\$5831
LKD48132K	48 x 132 x 29-29.5	150	164	10	\$5962	\$6275
LKD48144K	48 x 144 x 29-29.5	125	181	10	\$6377	\$6717
LKD48156K	48 x 156 x 29-29.5	150	191	11	\$6792	\$7161
LKD48168K	48 x 168 x 29-29.5	125	206	11	\$7206	\$7603
LKD48180K	48 x 180 x 29-29.5	125	220	12	\$7621	\$8047
LKD54144K	54 x 144 x 29-29.5	150	193	11	\$7032	\$7415
LKD54168K	54 x 168 x 29-29.5	150	214	12	\$7960	\$8408
LKD60144K	60 x 144 x 29-29.5	150	206	12	\$7640	\$8066
LKD60168K	60 x 168 x 29-29.5	150	227	13	\$8668	\$9165

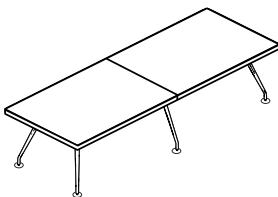

Rectangular Table - 2 piece top

Tops feature hardwood edge and metal inserts for ease of assembly to base. Also includes six legs, four 90-degree connectors, two 3-way connectors and four leg beams.

Required Specifications

Top Finish
Leg Finish
Edge Style

Optional Specifications

Grommet

Accessories

Power Block

RECTANGULAR TABLES - VENEER

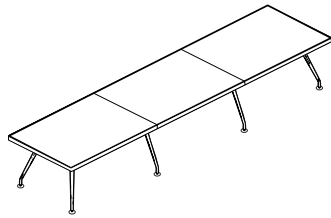

Rectangular Table - 3 piece top

MODEL# DIMENSIONS FREIGHT CLASS WT/LBS. CUBIC FT. KF EDGE KV EDGE

	D x W x H					
LKD48192K	48 x 192 x 29-29.5	150	279	14	\$8531	\$8985
LKD54192K	54 x 192 x 29-29.5	150	288	15	\$9388	\$9899
LKD54216K	54 x 216 x 29-29.5	150	270	16	\$10317	\$10891
LKD54240K	54 x 240 x 29-29.5	150	298	17	\$11246	\$11883
LKD60192K	60 x 192 x 29-29.5	150	257	16	\$10200	\$10768
LKD60216K	60 x 216 x 29-29.5	150	283	17	\$11227	\$11864
LKD60240K	60 x 240 x 29-29.5	150	311	18	\$12255	\$12963

Tops feature hardwood edge and metal inserts for ease of assembly to base. Also includes eight legs, four 90-degree connectors, four 3-way connectors and eight leg beams.

Required Specifications

Top Finish
Leg Finish
Edge Style

Optional Specifications

Grommet

Accessories

Power Block

WIRE MANAGEMENT



Cable Snake

MODEL #	DIMENSIONS D x W x H	FREIGHT CLASS	WT/LB.	CUBIC FT.	LIST PRICE
PCSN01	-- x -- x --	92.5	2.10	.20	\$106

Flexible cable management. Provides access to power/data from floor to underside of worksurface where it attaches. Two pathways within Cable Snake. Length under desk is 31.25". Silver (**SIL**) plastic only.

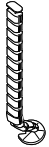

Cable Snake

BRTCS	2 x 8 x 30	70	3	.19	\$111
-------	------------	----	---	-----	--------------

Flexible cable management trough. Two pathways within the snake, one for data/communication and one for routing power cables. Translucent White finish only.

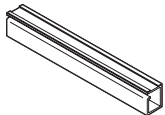

Wire Manager

PEWM5.5	2 x 66 x 2	70	.60	.10	\$156
PEWM5	2 x 60 x 2	70	.60	.10	\$131
PEWM4.5	2 x 54 x 2	70	.50	.10	\$117
PEWM4	2 x 48 x 2	70	.50	.10	\$106
PEWM3.5	2 x 42 x 2	70	.40	.10	\$91
PEWM3	2 x 36 x 2	70	.40	.10	\$81
PEWM2.5	2 x 30 x 2	70	.30	.10	\$66
PEWM2	2 x 24 x 2	70	.30	.10	\$55
PEWM1.5	2 x 18 x 2	70	.20	.10	\$42
PEWM1	2 x 12 x 2	70	.20	.10	\$30

Plastic tray flexes to receive and hold electrical and data wires. Quickly attaches with two strips of double-sided tape. Black (**BLK**) only.

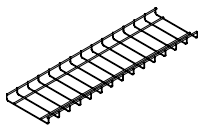

Power/Data Cable Basket

BRTCB76KIT	8 x 34 x 1	70	1.56	.15	\$193
BRTCB70	8 x 70 x 1	100	3.22	.34	\$140
BRTCB64	8 x 64 x 1	92.5	2.94	.29	\$129
BRTCB58	8 x 58 x 1	92.5	2.66	.26	\$126
BRTCB52	8 x 52 x 1	100	2.39	.24	\$118
BRTCB46	8 x 46 x 1	92.5	2.16	.21	\$112
BRTCB40	8 x 40 x 1	70	1.80	.18	\$105
BRTCB34	8 x 34 x 1	70	1.56	.15	\$101
BRTCB28	8 x 28 x 1	70	1.20	.13	\$89
BRTCB22	8 x 22 x 1	70	1.01	.10	\$84
BRTCB16	8 x 16 x 1	70	.73	.07	\$78
BRTCB8	8 x 8 x 1	70	.36	.03	\$71

Shallow, 8" wide basket manages cable excess and serves to manage cords and cables. It can be easily unclipped from spring steel brackets (included) to rearrange cable connections from below worksurface. Spring steel brackets can suspend the Cable Basket below the worksurface where it keeps the cords and cables off the floor and manages them along the horizontal plane - between floor monuments and Storage Vertical Cable Manager, for example. Tall storage cabinet's legs provide easy access to the Cable Basket where it can easily be unclipped from spring steel brackets to rearrange cable connections. Steel wire construction, chrome finish baskets; black spring steel hanging brackets, fasteners.

SWAP TABLES

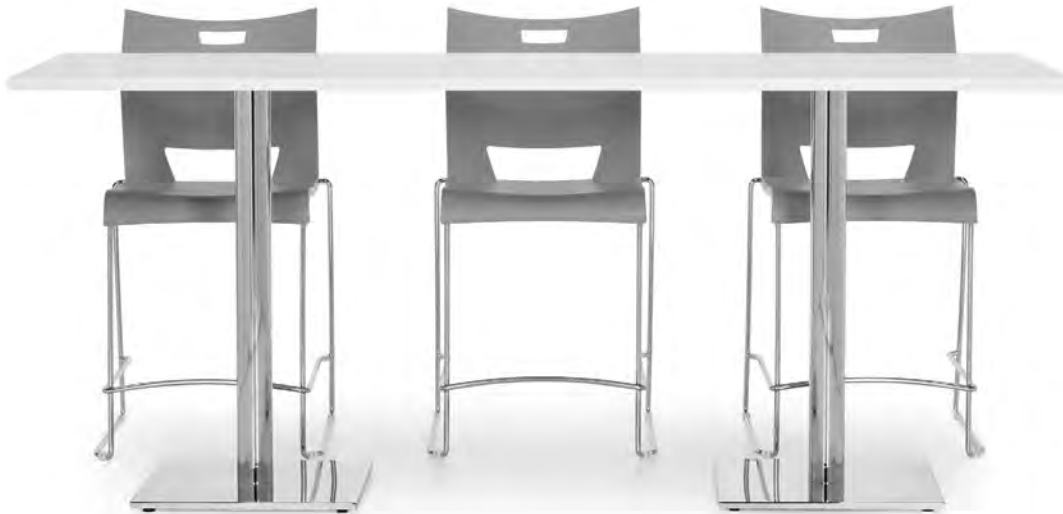

Global's Swap collection is a comprehensive offering including laptop tables, casual meeting tables, café tables, huddle tables and more. Suitable for a variety of applications: break rooms, dedicated/enclosed meeting rooms, casual/open area meeting spaces (lounge, seated, counter and bar height options), and private office (accommodate smaller 3-4 person discussions). Tops and bases are sold separately for ease of specification. Mix and match capabilities to create spaces for multi-purpose use. Choose your top, choose your base. Create the combination you desire for the way you want to work.



Features and Benefits

- All worksurfaces are 1" thick, constructed of 45 lb. density particle board covered on both sides with high performance, thermally fused laminate.
- Worksurfaces feature Global's preferred edge on all sides
- Bases are constructed of a solid steel metal plate and cover - round or square.
- Wire grommets and power block cutouts are available on most tables
- 6 heights:
Coffee table height at 16"H overall
End table height at 22"H
Lounge height at 25.5"H
Seated height at 29"H
Counter height at 36"H
Bar height at 41.5"H



½" thick steel square and round metal bases



Power management in select columns



Factory installed metal inserts for easy metal-to-metal base connection

GENERAL INFORMATION

- SWAP is a series of tables for use primarily in casual meeting spaces, lounges and café areas.
- A new way of specifying the exact worksurface requirements for today's shared spaces or to meet the needs of growing companies. What you choose today can be moved around or added to as the company changes and grows.
- Finish palette coordinates with most Global laminate casegoods series – tables can stand alone or blend with other solutions.
- Each component is packed individually. Bases are shipped assembled, one per carton. Easy to assemble.
- Global's counter and bar height stools are a perfect compliment to swap tables with counter and bar height bases.
- For environmental certifications, please visit globalfurnituregroup.com

TOPS

- All worksurfaces are 1" thick, constructed of 45 lb. density particleboard covered on both sides with high performance, thermally fused laminate
- Worksurfaces feature Global's preferred matching edge on all sides
- High pressure tops are available in all Swap laminate finishes at an extended lead time. Please see model # for pricing and availability
- High pressure tops are recommended for counter applications and other high use areas
- Products specified with the high pressure laminate option are finished on the underside of the surface with a kraft paper backing.
- Worksurfaces of 96" or less in length are standard in one piece (one carton)
- Worksurfaces 120" to 144" in length are standard in two pieces (two cartons)
- Worksurfaces 96", 120" and 144" x 48" include support channels

LAPTOP TABLES

- Round, square and rectangular tops are available with center or 3" off-centered mounting options.
- Tops are available in TFL and HP laminate options with matching edge band and include factory installed metal inserts for ease of assembly.
- Two base styles available: 14" diameter round base plate with centered column or 12.5" square base plate with centered or off-set column. 1.5" diameter column.
- Weighted base for balance includes cover plate, 0.5" adjustable leveling glides and machine screws for attaching the bases to Swap tops.

BASES

- **Caution:** to meet BIFMA standards for performance and stability, appropriate base size must be specified with corresponding top sizes identified. **Top plates and base plates vary by base size and will only work with table shape sizes as referenced on the following pages.**
- Bases are constructed of a round or square solid steel metal plate for counter balance, covered with a finished steel shroud, affixed with four bolts to a 3" diameter cold rolled steel tube.
- GRB14H25 attach to tops with a 6" x 6" steel plate, welded to a 1.5" diameter steel tube, bolted to a 0.5" thick solid steel counter balance. Not to be used on tops greater than 22" x 22" in size.
- GSB13H25 and GSOB13H25 attach to tops with a 6" x 6" steel plate, welded to a 1.5" diameter steel tube, bolted to a 0.5" thick solid steel counter balance. Not to be used on tops greater than 22" x 22" in size.
- GRB22H15, GRB22H21, GRB22H26, GRB22, GRB22H35, GRB22H41, GSB19H15, GSB19H21, GSB19H26, GSB19, GSB19H35 and GSB19H41 attach to tops with a 6" x 6" steel plate, welded to a 3" diameter steel tube, bolted to a 0.5" thick solid steel counter balance.
- **Top plate and base plate of GRB22 and GSB19 models in all heights, have pass-through cut-outs to accommodate a single port simplex or dual USB module to deliver power or USB charging to the surface.** This allows the module to be mounted directly above the base and to pass the unit's cord through the base column resulting in the cord and plug head exiting from the bottom of the base for plugging into a floor or wall mount power source.
- GRB28, GRB34, GSB23 and GSB28 attach to tops with an 11" x 11" steel plate, welded to a 4" diameter steel tube, bolted to a 0.375" thick solid steel counter balance.
- Bases are available PAINTED in Black (**BLK**), Tungsten (**TUN**) and Designer White (**DWT**). Paint has a "sandtex" finish for extra durability.
- Bases are available in Chrome (**CH**) or Brushed Chrome (**BCH**) at an upcharge and with an extended lead time. Please see model # for pricing.
- All bases come with six 0.5" height adjustable glides for leveling on uneven floors
- Coffee table height bases with 14"H column and 0.375"H levelers
- End table height bases with 20"H column and 0.375"H levelers
- Lounge height bases with 26"H column and 0.375"H levelers
- Seated height bases with 27"H column and 0.375"H levelers.
- Counter height bases with 34"H column and 0.375"H levelers.
- Bar height bases with 39.5"H column and 0.375"H levelers.
- Round bases available in 22", 28" and 34" dia.
- Square bases available in 18.5", 22.5" and 28.5".

1. SPECIFY MODEL NUMBER

2. SPECIFY FINISH

Laminate Worksurface + Base Finishes:

ACJ	Absolute Acajou	HGT	Hayden Grey
ASN	Asian Night	QTM	Quartered Mahogany
AWC	Avant Cherry	SOG	Storm Grey
AWH	Avant Honey	TFW	Tiger Fruitwood
BLK	Black	TWL	Tiger Walnut
BRC	Brushed Cobalt	WHE	Walnut Heights
CMB	Clear Maple	WHC	White Chocolate
DES	Dark Espresso	WCR	Winter Cherry
DWT	Designer White	WGY	Willow Grey

Bases - Painted:

BLK	Black
DWT	Designer White
TUN	Tungsten

Bases - Plated (Upcharge applies):

BCH	Brushed Chrome
CH	Polished Chrome

3. SPECIFY OPTIONS

POWER BLOCKS AND CUT-OUT LOCATIONS

- A power block delivers power/data to the table surface
- Power block modules are ordered separately
- Not all power block locations are available on all table sizes. Please refer to top/base chart on the following pages for more information.
- To purchase a power block, you must specify both the power block cut-out location when ordering the top. Order the power block separately.
- Optional cut-out available in standard worksurface locations (left, center or right) for all table shapes.

Order as **E1, U1, A1, J1, K1, M1**, etc. **Add \$69** for each cut-out.

- Cut-outs may be placed in non-standard locations.

Order as **ES, US, AS, JS, KS, MS** - **Add \$69**.

A drawing must be supplied with vertical and horizontal dimensions to the center of the cutout. Please refer to the CUSTOM GROMMET LOCATION FORM in the back reference section. Cutouts may NOT be placed directly over the bases.

- Select power block from Productivity Solutions, page 540.

SINGLE PORT MODULES





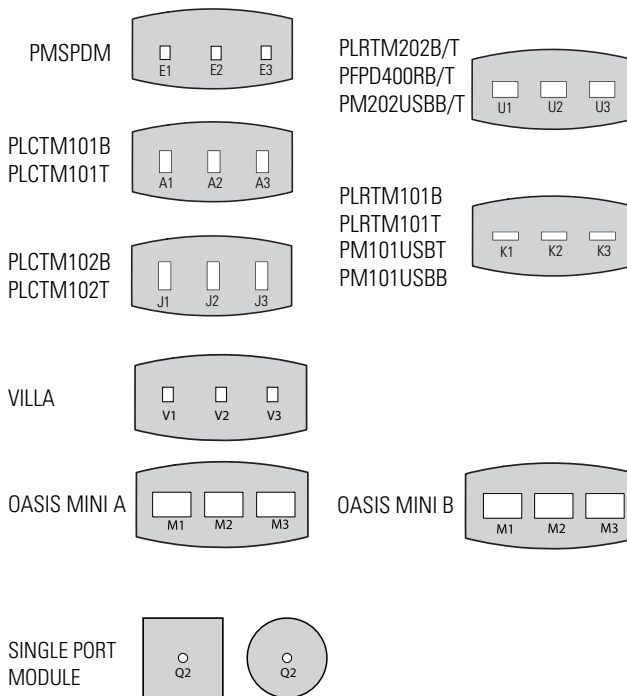





- Single port module with one simplex or dual USB charging port centered over base available for tops supported with single GRB22xx or GSB19xx base in any height
- Modules are listed on product pages with applicable tops and bases. Modules are ordered separately.
- Specify optional cut-out **Q2** to accommodate. **Add \$69**.

PRODUCT CODE DIAGRAM



S SWAP TABLES - NOTES

APPLICABLE BASE OPTIONS FOR CORRESPONDING TOP										POWER MGMT OPTIONS		
Table Shape/Size	Model # for Top	Lounge Height 27"H		Seated Height 29"H		Counter Height 36"H		Bar Height 41.5"h		Base Qty.	# top pieces	Optional Cutouts in Tops applicable for power modules ordered separately
		Round base 22"	Square base 19"	Round base 22", 28", 34"	Square base 18.5", 22.5", 8.5"	Round base 22"	Square base 18.5"	Round base 22"	Square base 18.5"			
Round <input type="radio"/> Nominal base plate dimension indicated by 4th and 5th characters in base model numbers.												
24" diameter	GRBTP24	GRB22H26	GSB19H26	GRB22	GSB19	GRB22H35	GSB19H35	GRB22H41	GSB19H41	1	1	Q2 only
30" diameter	GRBTP30	GRB22H26	GSB19H26	GRB22	GSB19	GRB22H35	GSB19H35	GRB22H41	GSB19H41	1	1	Q2 only
36" diameter	GRBTP36	GRB22H26	GSB19H26	GRB22	GSB19	GRB22H35	GSB19H35	GRB22H41	GSB19H41	1	1	Q2 only
42" diameter	GRBTP42	N/A	N/A	GRB28	GSB23	N/A	N/A	N/A		1	1	None
48" diameter	GRBTP48	N/A	N/A	GRB28	GSB23	N/A	N/A	N/A		1	1	None
54" diameter	GRBTP54	N/A	N/A	GRB34	GSB28	N/A	N/A	N/A		1	1	None
60" diameter	GRBTP60	N/A	N/A	GRB34	GSB28	N/A	N/A	N/A		1	1	None
Square <input type="checkbox"/>												
24" square	GSBTP24	GRB22H26	GSB19H26	GRB22	GSB19	GRB22H35	GSB19H35	GRB22H41	GSB19H41	1	1	Q2 only
30" square	GSBTP30	GRB22H26	GSB19H26	GRB22	GSB19	GRB22H35	GSB19H35	GRB22H41	GSB19H41	1	1	Q2 only
36" square	GSBTP36	GRB22H26	GSB19H26	GRB22	GSB19	GRB22H35	GSB19H35	GRB22H41	GSB19H41	1	1	Q2 only
42" square	GSBTP42	N/A	N/A	GRB28	GSB23	N/A	N/A	N/A	N/A	1	1	None
48" square	GSBTP48	N/A	N/A	GRB28	GSB23	N/A	N/A	N/A	N/A	1	1	None
54" square	GSBTP54	N/A	N/A	N/A	N/A	N/A	N/A	N/A	N/A	1	1	None
60" square	GSBTP60	N/A	N/A	N/A	N/A	N/A	N/A	N/A	N/A	1	1	None
Rectangular <input type="checkbox"/>												
30x24 Rectangular	GSBTP2430	GRB22H26	GSB19H26	GRB22	GSB19	GRB22H35	GSB19H35	GRB22H41	GSB19H41	1	1	Q2 only
36x24 Rectangular	GSBTP2436	GRB22H26	GSB19H26	GRB22	GSB19	GRB22H35	GSB19H35	GRB22H41	GSB19H41	1	1	Q2 only
36x30 Rectangular	GSBTP3036	GRB22H26	GSB19H26	GRB22	GSB19	GRB22H35	GSB19H35	GRB22H41	GSB19H41	1	1	Q2 only
42x30 Rectangular	GSBTP3042	N/A	N/A	GRB28	GSB23	N/A	N/A	N/A	N/A	1	1	None
42x36 Rectangular	GSBTP3642	N/A	N/A	GRB28	GSB23	N/A	N/A	N/A	N/A	1	1	None
60X24 Rectangular	GRT5STP	GRB22H26	GSB19H26	N/A	N/A	GRB22H35	GSB19H35	GRB22H41	GSB19H41	2	1	Center: A2, E2, J2, K2, U2
66X24 Rectangular	GRT5HSTP	GRB22H26	GSB19H26	N/A	N/A	GRB22H35	GSB19H35	GRB22H41	GSB19H41	2	1	
72X24 Rectangular	GRT6STP	GRB22H26	GSB19H26	N/A	N/A	GRB22H35	GSB19H35	GRB22H41	GSB19H41	2	1	
84X24 Rectangular	GRT7STP	GRB22H26	GSB19H26	N/A	N/A	GRB22H35	GSB19H35	GRB22H41	GSB19H41	2	1	3 positions - Left/ Center/Right
96X24 Rectangular	GRT8STP	GRB22H26	GSB19H26	N/A	N/A	GRB22H35	GSB19H35	GRB22H41	GSB19H41	2	1	
60x30 Rectangular	GRT5NTP	GRB22H26	GSB19H26	GRB22	GSB19	GRB22H35	GSB19H35	GRB22H41	GSB19H41	2	1	Center: A2, E2, J2, K2, M2, U2
60x36 Rectangular	GRT5TP	GRB22H26	GSB19H26	GRB22	GSB19	GRB22H35	GSB19H35	GRB22H41	GSB19H41	2	1	
66x30 Rectangular	GRT5NHTP	GRB22H26	GSB19H26	GRB22	GSB19	GRB22H35	GSB19H35	GRB22H41	GSB19H41	2	1	
66x36 Rectangular	GRT5HTP	GRB22H26	GSB19H26	GRB22	GSB19	GRB22H35	GSB19H35	GRB22H41	GSB19H41	2	1	
72x30 Rectangular	GRT6NTP	GRB22H26	GSB19H26	GRB22	GSB19	GRB22H35	GSB19H35	GRB22H41	GSB19H41	2	1	
72x36 Rectangular	GRT6TP	GRB22H26	GSB19H26	GRB22	GSB19	GRB22H35	GSB19H35	GRB22H41	GSB19H41	2	1	3 positions - Left/ Center/Right
84x30 Rectangular	GRT7NTP	GRB22H26	GSB19H26	GRB22	GSB19	GRB22H35	GSB19H35	GRB22H41	GSB19H41	2	1	
84x36 Rectangular	GRT7TP	GRB22H26	GSB19H26	GRB22	GSB19	GRB22H35	GSB19H35	GRB22H41	GSB19H41	2	1	
96x30 Rectangular	GRT8NTP	GRB22H26	GSB19H26	GRB22	GSB19	GRB22H35	GSB19H35	GRB22H41	GSB19H41	2	1	A1/2/3, E1/2/3, J1/2/3, K1/2/3, M1/2/3, U1/2/3
96x36 Rectangular	GRT8TP	GRB22H26	GSB19H26	GRB22	GSB19	GRB22H35	GSB19H35	GRB22H41	GSB19H41	2	1	
96x42 Rectangular	GRT8MTP	N/A	N/A	GRB28	GSB23	N/A	N/A	N/A	N/A			
96x48 Rectangular	GRT8WTP	N/A	N/A	GRB28	GSB23	N/A	N/A	N/A	N/A	2	1	
120x48 Rectangular	GRT10WTP	N/A	N/A	GRB28	GSB23	N/A	N/A	N/A	N/A	3	2	Both ends: A1/3, E1/3, J1/3, K1/3, M1/3, U1/3
144x48 Rectangular	GRT12WTP	N/A	N/A	GRB28	GSB23	N/A	N/A	N/A	N/A	3	2	

APPLICABLE BASE OPTIONS FOR CORRESPONDING TOP											POWER MGMT OPTIONS	
Table Shape/Size	Model # for Top	Lounge Height 27"H		Seated Height 29"H		Counter Height 36"H		Bar Height 41.5"h		Base Qty.	# top pieces	Optional Cutouts in Tops applicable for power modules ordered separately
		Round base 22" 	Square base 19" 	Round base 22", 28", 34" 	Square base 18.5", 22.5", 8.5" 	Round base 22" 	Square base 18.5" 	Round base 22" 	Square base 18.5" 			
Racetrack 												
Nominal base plate dimension indicated by 4th and 5th characters in base model numbers.												
60X24 Racetrack	GRC5STP	GRB22H26	GSB19H26	N/A	N/A	GRB22H35	GSB19H35	GRB22H41	GSB19H41	2	1	Center: A2 E2 J2 K2 U2
66X24 Racetrack	GRC5HSTP	GRB22H26	GSB19H26	N/A	N/A	GRB22H35	GSB19H35	GRB22H41	GSB19H41	2	1	
72X24 Racetrack	GRC6STP	GRB22H26	GSB19H26	N/A	N/A	GRB22H35	GSB19H35	GRB22H41	GSB19H41	2	1	
84X24 Racetrack	GRC7STP	GRB22H26	GSB19H26	N/A	N/A	GRB22H35	GSB19H35	GRB22H41	GSB19H41	2	1	3 positions - Left/ Center/Right
96X24 Racetrack	GRC8STP	GRB22H26	GSB19H26	N/A	N/A	GRB22H35	GSB19H35	GRB22H41	GSB19H41	2	1	
60x30 Racetrack	GRC5NTP	GRB22H26	GSB19H26	GRB22	GSB19	GRB22H35	GSB19H35	GRB22H41	GSB19H41	2	1	Center: A2 E2 J2 K2 M2 U2
60X36 Racetrack	GRC5TP	GRB22H26	GSB19H26	GRB22	GSB19	GRB22H35	GSB19H35	GRB22H41	GSB19H41	2	1	
66x30 Racetrack	GRC5NHTP	GRB22H26	GSB19H26	GRB22	GSB19	GRB22H35	GSB19H35	GRB22H41	GSB19H41	2	1	
66X36 Racetrack	GRC5HTP	GRB22H26	GSB19H26	GRB22	GSB19	GRB22H35	GSB19H35	GRB22H41	GSB19H41	2	1	
72x30 Racetrack	GRC6NTP	GRB22H26	GSB19H26	GRB22	GSB19	GRB22H35	GSB19H35	GRB22H41	GSB19H41	2	1	
72x36 Racetrack	GRC6TP	GRB22H26	GSB19H26	GRB22	GSB19	GRB22H35	GSB19H35	GRB22H41	GSB19H41	2	1	
84x30 Racetrack	GRC7NTP	GRB22H26	GSB19H26	GRB22	GSB19	GRB22H35	GSB19H35	GRB22H41	GSB19H41	2	1	3 positions - Left/ Centered/Right (E1, E2, E3; V1/2/3; M1/2/3)
84x36 Racetrack	GRC7TP	GRB22H26	GSB19H26	GRB22	GSB19	GRB22H35	GSB19H35	GRB22H41	GSB19H41	2	1	
96x30 Racetrack	GRC8NTP	GRB22H26	GSB19H26	GRB22	GSB19	GRB22H35	GSB19H35	GRB22H41	GSB19H41	2	1	
96x36 Racetrack	GRC8TP	GRB22H26	GSB19H26	GRB22	GSB19	GRB22H35	GSB19H35	GRB22H41	GSB19H41	2	1	
96x42 Racetrack	GRC8MTP	N/A	N/A	GRB28	GSB23	N/A	N/A	N/A	N/A	2	1	
96x48 Racetrack	GRC8WTP	N/A	N/A	GRB28	GSB23	N/A	N/A	N/A	N/A	2	1	Both ends: A1/3, E1/3, J1/3, K1/3, M1/3, U1/3
120x48 Racetrack	GRC10WTP	N/A	N/A	GRB28	GSB23	N/A	N/A	N/A	N/A	3	2	
144x48 Racetrack	GRC12WTP	N/A	N/A	GRB28	GSB23	N/A	N/A	N/A	N/A	3	2	
Boat Shape 												
60X24 Boat shape	GBT5STP	GRB22H26	GSB19H26	N/A	N/A	GRB22H35	GSB19H35	GRB22H41	GSB19H41	2	1	Center: A2 E2 J2 K2 U2
66X24 Boat shape	GBT5HSTP	GRB22H26	GSB19H26	N/A	N/A	GRB22H35	GSB19H35	GRB22H41	GSB19H41	2	1	
72X24 Boat shape	GBT6STP	GRB22H26	GSB19H26	N/A	N/A	GRB22H35	GSB19H35	GRB22H41	GSB19H41	2	1	
84X24 Boat shape	GBT7STP	GRB22H26	GSB19H26	N/A	N/A	GRB22H35	GSB19H35	GRB22H41	GSB19H41	2	1	3 positions - Left/ Center/Right
96X24 Boat shape	GBT8STP	GRB22H26	GSB19H26	N/A	N/A	GRB22H35	GSB19H35	GRB22H41	GSB19H41	2	1	
60x30 Boat shape	GBT5NTP	GRB22H26	GSB19H26	GRB22	GSB19	GRB22H35	GSB19H35	GRB22H41	GSB19H41	2	1	Center: A2 E2 J2 K2 M2 U2
60X36 Boat shape	GBT5TP	GRB22H26	GSB19H26	GRB22	GSB19	GRB22H35	GSB19H35	GRB22H41	GSB19H41	2	1	
66x30 Boat shape	GBT5NHTP	GRB22H26	GSB19H26	GRB22	GSB19	GRB22H35	GSB19H35	GRB22H41	GSB19H41	2	1	
66X36 Boat shape	GBT5HTP	GRB22H26	GSB19H26	GRB22	GSB19	GRB22H35	GSB19H35	GRB22H41	GSB19H41	2	1	
72x30 Boat shape	GBT6NTP	GRB22H26	GSB19H26	GRB22	GSB19	GRB22H35	GSB19H35	GRB22H41	GSB19H41	2	1	
72x36 Boat shape	GBT6TP	GRB22H26	GSB19H26	GRB22	GSB19	GRB22H35	GSB19H35	GRB22H41	GSB19H41	2	1	
84x30 Boat shape	GBT7NTP	GRB22H26	GSB19H26	GRB22	GSB19	GRB22H35	GSB19H35	GRB22H41	GSB19H41	2	1	3 positions - Left/ Center/Right A1/2/3, E1/2/3, J1/2/3, K1/2/3, M1/2/3, U1/2/3
84x36 Boat shape	GBT7TP	GRB22H26	GSB19H26	GRB22	GSB19	GRB22H35	GSB19H35	GRB22H41	GSB19H41	2	1	
96x30 Boat shape	GBT8NTP	GRB22H26	GSB19H26	GRB22	GSB19	GRB22H35	GSB19H35	GRB22H41	GSB19H41	2	1	
96x36 Boat shape	GBT8TP	GRB22H26	GSB19H26	GRB22	GSB19	GRB22H35	GSB19H35	GRB22H41	GSB19H41	2	1	
96X42 Boat shape	GBT8MTP	N/A	N/A	GRB28	GSB23	N/A	N/A	N/A	N/A	2	1	
96x48 Boat shape	GBT8WTP	N/A	N/A	GRB28	GSB23	N/A	N/A	N/A	N/A	2	1	Both ends: A1/3, E1/3, J1/3, K1/3, M1/3, U1/3
120x48 Boat shape	GBT10WTP	N/A	N/A	GRB28	GSB23	N/A	N/A	N/A	N/A	3	2	
144x48 Boat shape	GBT12WTP	N/A	N/A	GRB28	GSB23	N/A	N/A	N/A	N/A	3	2	

S SWAP TABLES - NOTES





APPLICABLE BASE OPTIONS FOR CORRESPONDING TOP						POWER MGMT OPTIONS		
Table Shape/Size	Model # for Top	Centered Column 25.5"H		Offset Column 25.5"H		Base Qty.	# top pieces	Optional Cutouts in Tops applicable for power modules ordered separately
		Round base 14" 	Square base 12.5" 	Round base N/A	Square base 12.5" 			
Round Laptop Tables ○ <i>Nominal base plate dimension indicated by 4th and 5th characters in base model numbers.</i>								
16" dia centered base	GRBTP16	GRB14H25	GSB13H25	N/A	N/A	1	1	None
20" dia centered base	GRBTP20	GRB14H25	GSB13H25	N/A	N/A	1	1	None
22" dia centered base	GRBTP24	GRB14H25	GSB13H25	N/A	N/A	1	1	None
16" dia offset base	GRBOTP16	N/A	N/A	N/A	GSOB13H25	1	1	None
20" dia offset base	GRBOTP20	N/A	N/A	N/A	GSOB13H25	1	1	None
22" dia offset base	GRBOTP22	N/A	N/A	N/A	GSOB13H25	1	1	None
Square Laptop Tables □								
16"x16" centered base	GSBTP16	GRB14H25	GSB13H25	N/A	N/A	1	1	None
20"x20" centered base	GSBTP20	GRB14H25	GSB13H25	N/A	N/A	1	1	None
22"x22" centered base	GSBTP22	GRB14H25	GSB13H25	N/A	N/A	1	1	None
16"x16" offset base	GSBOTP16	N/A	N/A	N/A	GSOB13H25	1	1	None
20"x20" offset base	GSBOTP20	N/A	N/A	N/A	GSOB13H25	1	1	None
22"x22" offset base	GSBOTP22	N/A	N/A	N/A	GSOB13H25	1	1	None
Rectangular Laptop Tables □								
16"x20" centered base	GSBTP1620	GRB14H25	GSB13H25	N/A	N/A	1	1	None
16"x22" centered base	GSBTP1622	GRB14H25	GSB13H25	N/A	N/A	1	1	None
16"x20" offset base	GSBOT1620	N/A	N/A	N/A	GSOB13H25	1	1	None
16"x22" offset base	GSBOT1622	N/A	N/A	N/A	GSOB13H25	1	1	None
APPLICABLE BASE OPTIONS FOR CORRESPONDING TOP						POWER MGMT OPTIONS		
Table Shape/Size	Model # for Top	Coffee Table 16"H		End Table 22"H		Base Qty.	# top pieces	Optional Cutouts in Tops applicable for power modules ordered separately
		Round base 22" 	Square base 18.5" 	Round base 22" 	Square base 18.5" 			
Round Coffee/End Tables ○ <i>*Nominal base plate dimension indicated by 4th and 5th characters in base model numbers.</i>								
24" dia	GRBTP24	GRB22H15	GSB19H15	GRB22H21	GSB19H21	1	1	Q2 only
30" dia	GRBTP30	GRB22H15	GSB19H15	GRB22H21	GSB19H21	1	1	Q2 only
36" dia	GRBTP36	GRB22H15	GSB19H15	GRB22H21	GSB19H21	1	1	Q2 only
Square Coffee/End Tables □								
24" square	GSBTP24	GRB22H15	GSB19H15	GRB22H21	GSB19H21	1	1	Q2 only
30" square	GSBTP30	GRB22H15	GSB19H15	GRB22H21	GSB19H21	1	1	Q2 only
36" square	GSBTP36	GRB22H15	GSB19H15	GRB22H21	GSB19H21	1	1	Q2 only

TABLE NOTES - ESTIMATED CAPACITY

- Use the following to determine the size of a table and the number of chairs needed for a conference area.
- All estimates are based on an average chair width of 23" with a 4" clearance between chairs. Adjust accordingly for a different chair size.

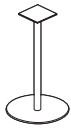
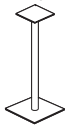
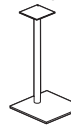
Top Size	NUMBER OF CHAIRS					
	Round	Square	Rectangular	Boat	Racetrack	
24 x 24	2	2	N/A	N/A	N/A	
24 x 30	N/A	N/A	2-3	N/A	N/A	
24 x 36	N/A	N/A	3-4	N/A	N/A	
30 x 30	3	4	N/A	N/A	N/A	
30 x 36	N/A	N/A	4	N/A	N/A	
30 x 42	N/A	N/A	4	N/A	N/A	
36 x 36	4	4	N/A	N/A	N/A	
36 x 42	N/A	N/A	4	N/A	N/A	
42 x 42	4	4	N/A	N/A	N/A	
48 x 48	4	4	N/A	N/A	N/A	
54 x 54	5	6	N/A	N/A	N/A	
60 x 60	5	6	N/A	N/A	N/A	
24 x 60	N/A	N/A	4-6	N/A	N/A	
24 x 66	N/A	N/A	4-6	N/A	N/A	
24 x 72	N/A	N/A	4-6	N/A	N/A	
24 x 84	N/A	N/A	4-6	N/A	N/A	
24 x 96	N/A	N/A	6-8	N/A	N/A	
30 x 60	N/A	N/A	4-6	4-6	4-6	
30 x 66	N/A	N/A	4-6	4-6	4-6	
30 x 72	N/A	N/A	4-6	4-6	4-6	
30 x 84	N/A	N/A	4-6	4-6	4-6	
30 x 96	N/A	N/A	6-8	6-8	6-8	
36 x 60	N/A	N/A	4-6	4-6	4-6	
36 x 66	N/A	N/A	4-6	4-6	4-6	
36 x 72	N/A	N/A	4-6	4-6	4-6	
36 x 84	N/A	N/A	4-6	4-6	4-6	
36 x 96	N/A	N/A	6-8	6-8	6-8	
48 x 84	N/A	N/A	6-8	6-8	6-8	
48 x 96	N/A	N/A	6-8	6-8	6-8	
48 x 120	N/A	N/A	8-10	8-10	8-10	
48 x 144	N/A	N/A	10-12	10-12	10-12	

S SWAP TABLES

LAPTOP TABLES FOR CENTER BASE

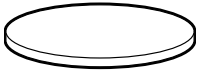

Round Tops, for Center Base

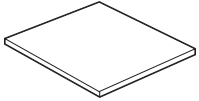

Square Tops, for Center Base

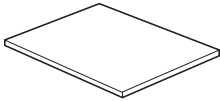

Rectangular Tops, for Center Base

MODEL#	DIMENSIONS	FREIGHT CLASS	WT./LBS.	CUBIC FT.	LIST PRICE	HP ADD	CHROME ADD
--------	------------	---------------	----------	-----------	------------	--------	------------

D x W x H

GRBTP16	16 x 16 x 1	70	6	.30	\$155	\$72	n/a
GRBTP20	20 x 20 x 1	70	9	.50	\$178	\$83	n/a
GRBTP22	22 x 22 x 1	70	9	.50	\$201	\$91	n/a

GSBTP16	16 x 16 x 1	65	7	.30	\$155	\$72	n/a
GSBTP20	20 x 20 x 1	70	11	.50	\$178	\$83	n/a
GSBTP22	22 x 22 x 1	65	13	.50	\$201	\$91	n/a

GSBTP1620	16 x 20 x 1	65	9	.40	\$162	\$79	n/a
GSBTP1622	16 x 22 x 1	70	11	.50	\$185	\$83	n/a

Tops feature metal inserts for ease of assembly to base. One base required. Use with round or square centered base only.

LAPTOP TABLES FOR OFFSET BASE

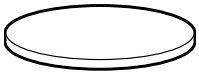

Round Tops, for Offset Base

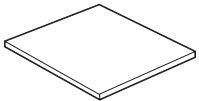

Square Tops, for Offset Base

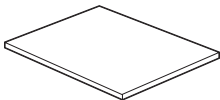

Rectangular Tops, for Offset Base

GRBOTP16	16 x 16 x 1	70	6	.30	\$155	\$72	n/a
GRBOTP20	20 x 20 x 1	70	9	.50	\$178	\$83	n/a
GRBOTP22	22 x 22 x 1	70	11	.70	\$201	\$91	n/a

GSBOTP16	16 x 16 x 1	65	7	.30	\$155	\$72	n/a
GSBOTP20	20 x 20 x 1	70	11	.50	\$178	\$83	n/a
GSBOTP22	22 x 22 x 1	70	13	.70	\$201	\$91	n/a

GSBOT1620	16 x 20 x 1	65	9	.40	\$162	\$79	n/a
GSBOT1622	16 x 22 x 1	70	11	.50	\$185	\$83	n/a

Tops feature metal inserts for ease of assembly to base. One base required. Tops are drilled to offset mount on either long or short side. Use tops for offset base with square offset base only.

LAPTOP TABLE BASES

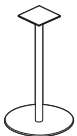

14" Round Centered Base

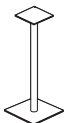

12.5" Square Centered Base

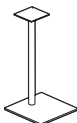

12.5" Square Offset Base

BASE SIZE AND STYLE OPTIONS VALID FOR TOPS ABOVE:

Order the quantity of bases as indicated by each top size

GRB14H25	14 x 14 x 24.5	150	17.54	3.50	\$546	n/a	\$105
----------	----------------	-----	-------	------	--------------	-----	--------------

GSB13H25	12.5 x 12.5 x 24.5	150	17.11	3.50	\$566	n/a	\$96
----------	--------------------	-----	-------	------	--------------	-----	-------------

GSOB13H25	12.5 x 12.5 x 24.5	150	17.11	3.50	\$566	n/a	\$96
-----------	--------------------	-----	-------	------	--------------	-----	-------------

1.5" diameter column. Weighted base for balance includes cover plate, 0.5" adjustable glides to level on uneven surfaces. Screws included with base for attaching to appropriate top(s). Available in Black (**BLK**), Tungsten (**TUN**) or Designer White (**DWT**).

- Chrome (**CH**) and Brushed Chrome (**BCH**) are available at an upcharge.

Required Specifications

Finish

Optional Specifications

HP laminate (tops)

Chrome base

TOPS 24" - 36" WIDE AND BASES



Round Tops*

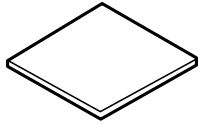

Square Tops*

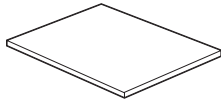

Rectangular Tops*

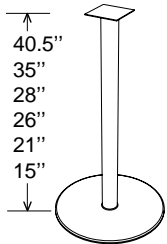

22" Dia Round Bases

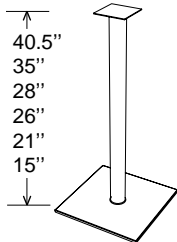

18.5" Square Bases



Single Port Module w/dual port USB-A



Single Port Module w/one Simplex

MODEL#	DIMENSIONS D x W x H	FREIGHT CLASS	WT./LBS.	CUBIC FT.	LIST PRICE	HP ADD	CHROME ADD
GRBTP24	24 x 24 x 1	70	20	1	\$178	\$89	n/a
GRBTP30	30 x 30 x 1	70	29	1.50	\$206	\$103	n/a
GRBTP36	36 x 36 x 1	70	40	2	\$263	\$132	n/a
GSBTP24	24 x 24 x 1	70	48	2.50	\$182	\$92	n/a
GSBTP30	30 x 30 x 1	70	31	1.50	\$213	\$107	n/a
GSBTP36	36 x 36 x 1	70	42	2	\$270	\$135	n/a
GSBTP2430	24 x 30 x 1	70	20	.91	\$204	\$92	n/a
GSBTP2436	24 x 36 x 1	70	24	1.08	\$222	\$100	n/a
GSBTP3036	30 x 36 x 1	65	31	1.34	\$256	\$116	n/a

Tops feature metal inserts for ease of assembly to base. One base required.

BASE SIZE AND STYLE OPTIONS VALID FOR TOPS ABOVE:

Order the quantity of bases as indicated by each top size

GRB22H15	22 x 22 x 15	92.5	47.60	4.69	\$663	n/a	\$105
GRB22H21	22 x 22 x 21	125	48.60	6.45	\$673	n/a	\$105
GRB22H26	22 x 22 x 26	125	50	8.15	\$683	n/a	\$105
GRB22	22 x 22 x 28	150	55	9.33	\$636	n/a	\$105
GRB22H35	22 x 22 x 35	150	57.10	12	\$667	n/a	\$116
GRB22H41	22 x 22 x 40.5	150	58.30	14	\$678	n/a	\$121

GRB22H15 - coffee table height

GRB22H21 - end table height

GRB22H26 - lounge height

GRB22 - seated height

GRB22H35 - counter height

GRB22H41 - bar height

GSB19H15	18.5 x 18.5 x 15	85	43.70	3.52	\$673	n/a	\$96
GSB19H21	18.5 x 18.5 x 21	100	44.80	4.84	\$683	n/a	\$96
GSB19H26	18.5 x 18.5 x 26	100	47	5.61	\$734	n/a	\$96
GSB19	18.5 x 18.5 x 28	100	50	6.06	\$689	n/a	\$96
GSB19H35	18.5 x 18.5 x 35	125	51.80	7.52	\$730	n/a	\$105
GSB19H41	18.5 x 18.5 x 40.5	125	53.20	8.77	\$756	n/a	\$116

GSB19H15 - coffee table height

GSB19H21 - end table height

GSB19H26 - lounge height

GSB19 - seated height

GSB19H35 - counter height

GSB19H41 - bar height

Base comes fully assembled and features 0.5" adjustable glides to level on uneven surfaces. Screws included with base for attaching to appropriate top(s). Available in Black (BLK), Tungsten (TUN) or Designer White (DWT). Base top plate and base plate include pass-through for single port power or USB module (sold separately).

- Chrome (CH) and Brushed Chrome (BCH) are available at an upcharge.

SPUSBRW72	2.25 x - x 2.75	70	1.20	1.18	\$250
SPUSBRB72	2.25 x - x 2.75	70	1.20	1.18	\$250

Single port module with dual USB-A charging ports. Specify top with Q2 cut-out to accommodate.

SPSMXRW72	2.25 x - x 2.75	70	1.75	1.18	\$112
SPSMXRB72	2.25 x - x 2.75	70	1.75	1.18	\$112

Single port module with one simplex. Specify top with Q2 cut-out to accommodate.

Required Specifications

Finish

Optional Specifications

HP laminate*
Chrome base
Cutout for single port module*

Accessories

Single port power or USB module

S SWAP TABLES

TOPS 42" - 48" WIDE AND BASES

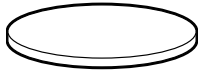

Round Tops*

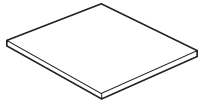

Square Tops*

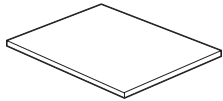

Rectangular Tops*

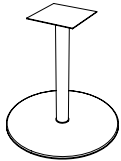

28" Round Base

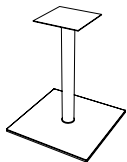

23" Square Base

MODEL#	DIMENSIONS	FREIGHT CLASS	WT./LBS.	CUBIC FT.	LIST PRICE	HP ADD	CHROME ADD
--------	------------	---------------	----------	-----------	------------	--------	------------

D x W x H

GRBTP42	42 x 42 x 1	70	48	2.50	\$366	\$184	n/a
GRBTP48	48 x 48 x 1	70	64	3	\$392	\$196	n/a
GSBTP42	42 x 42 x 1	70	50	2.50	\$374	\$188	n/a
GSBTP3042	30 x 42 x 1	65	36	1.55	\$302	\$136	n/a
GSBTP3642	36 x 42 x 1	65	43	1.86	\$379	\$171	n/a

Tops feature metal inserts for ease of assembly to base. One base required.

BASE SIZE AND STYLE OPTIONS VALID FOR TOPS ABOVE:

Order the quantity of bases as indicated by each top size

GRB28	28 x 28 x 28	125	100	15.63	\$1096	n/a	\$116
seated height							
GSB23	22.5 x 22.5 x 28	100	82	9.33	\$1007	n/a	\$64
seated height							

Base comes fully assembled and features 0.5" adjustable glides to level on uneven surfaces. Screws included with base for attaching to appropriate top(s). Available in Black (**BLK**), Tungsten (**TUN**) or Designer White (**DWT**).

- Chrome (**CH**) and Brushed Chrome (**BCH**) are available at an upcharge.

Required Specifications

Finish

Optional Specifications

HP laminate (tops)

Chrome base

TOPS 54"- 60" WIDE AND BASES



Round Tops*

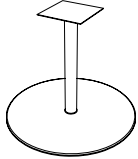

34" Round Base

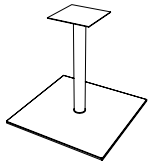

28" Square Base

MODEL#	DIMENSIONS	FREIGHT CLASS	WT/LBS.	CUBIC FT.	LIST PRICE	HP ADD	CHROME ADD
	D x W x H						
GRBTP54	54 x 54 x 1	70	78	3.75	\$524	\$262	n/a
GRBTP60	60 x 60 x 1	70	98	4.50	\$542	\$272	n/a

Tops feature metal inserts for ease of assembly to base. One base required.

**BASE SIZE AND STYLE OPTIONS VALID FOR TOPS ABOVE:
Order the quantity of bases as indicated by each top size**

GRB34	34 x 34 x 28	125	135	20.56	\$1341	n/a	\$116
-------	--------------	-----	-----	-------	---------------	-----	--------------

seated height

GSB28	28.5 x 28.5 x 28	125	125	15.63	\$1252	n/a	\$54
-------	------------------	-----	-----	-------	---------------	-----	-------------

seated height

Base comes fully assembled and features 0.5" adjustable glides to level on uneven surfaces. Screws included with base for attaching to appropriate top(s). Available in Black (**BLK**), Tungsten (**TUN**) or Designer White (**DWT**).

- Chrome (**CH**) and Brushed Chrome (**BCH**) are available at an upcharge.

Required Specifications
Finish

Optional Specifications
HP laminate*
Chrome base

S SWAP TABLES

24"D LOUNGE TOPS AND BASES

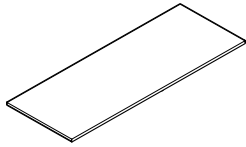

Rectangular Tops*

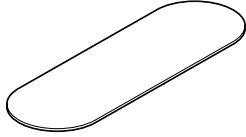

Racetrack Tops*

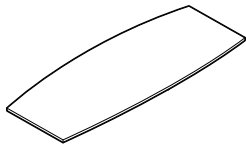

Boat Tops*

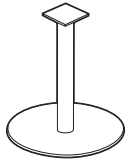

22" Round Bases

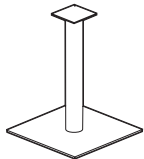

18.5" Square Bases

MODEL#	DIMENSIONS D x W x H	FREIGHT CLASS	WT/LBS.	CUBIC FT.	LIST PRICE	HP ADD	CHROME ADD
GRT5STP	24 x 60 x 1	65	41	1.79	\$345	\$155	n/a
GRT5HSTP	24 x 66 x 1	65	46	1.97	\$403	\$182	n/a
GRT6STP	24 x 72 x 1	65	49	2.14	\$420	\$189	n/a
GRT7STP	24 x 84 x 1	65	57	2.49	\$487	\$219	n/a
GRT8STP	24 x 96 x 1	65	66	2.84	\$523	\$235	n/a

GRC5STP	24 x 60 x 1	65	41	1.79	\$345	\$155	n/a
GRC5HSTP	24 x 66 x 1	65	46	1.97	\$403	\$182	n/a
GRC6STP	24 x 72 x 1	65	49	2.14	\$420	\$189	n/a
GRC7STP	24 x 84 x 1	65	57	2.49	\$487	\$219	n/a
GRC8STP	24 x 96 x 1	65	66	2.84	\$523	\$235	n/a

GBT5STP	24 x 60 x 1	65	41	1.79	\$345	\$155	n/a
GBT5HSTP	24 x 66 x 1	65	46	1.97	\$403	\$182	n/a
GBT6STP	24 x 72 x 1	65	49	2.14	\$420	\$189	n/a
GBT7STP	24 x 84 x 1	65	57	2.49	\$487	\$219	n/a
GBT8STP	24 x 96 x 1	65	66	2.84	\$523	\$235	n/a

One piece tops feature metal inserts for ease of assembly to base. Two bases required.

BASE SIZE AND STYLE OPTIONS VALID FOR TOPS ABOVE:

Order the quantity of bases as indicated by each top size

GRB22H26 loung height	22 x 22 x 26	125	50	8.15	\$683	n/a	\$105
--------------------------	--------------	-----	----	------	--------------	-----	--------------

GSB19H26 loung height	18.5 x 18.5 x 26	100	47	5.61	\$734	n/a	\$96
--------------------------	------------------	-----	----	------	--------------	-----	-------------

Base comes fully assembled and features 0.5" adjustable glides to level on uneven surfaces. Screws included with base for attaching to appropriate top(s). Available in Black (**BLK**), Tungsten (**TUN**) or Designer White (**DWT**).

- Chrome (**CH**) and Brushed Chrome (**BCH**) are available at an upcharge.

Required Specifications

Finish

Optional Specifications

HP laminate
Chrome base

TOPS 60"-96" WIDE AND BASES

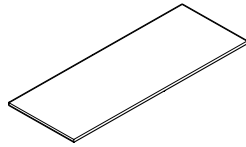

Rectangular Tops*

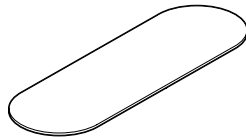

Racetrack Tops*

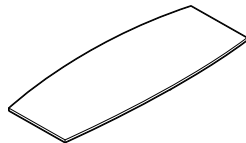

Boat Tops*

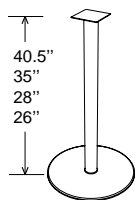

22" Dia Round Bases

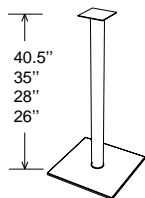

18.5" Square Bases

MODEL#	DIMENSIONS	FREIGHT CLASS	WT./LBS.	CUBIC FT.	LIST PRICE	HP ADD	CHROME ADD
D x W x H							
GRT5NTP	30 x 60 x 1	85	56	3.75	\$393	\$197	n/a
GRT5NHTP	30 x 66 x 1	65	56	2.44	\$396	\$179	n/a
GRT6NTP	30 x 72 x 1	100	61	6.50	\$426	\$214	n/a
GRT7NTP	30 x 84 x 1	100	72	7.50	\$531	\$266	n/a
GRT8NTP	30 x 96 x 1	100	80	8.50	\$578	\$290	n/a
GRT5TP	36 x 60 x 1	100	56	6.60	\$402	\$181	n/a
GRT5HTP	36 x 66 x 1	92.5	79	7.21	\$423	\$191	n/a
GRT6TP	36 x 72 x 1	92.5	75	7.50	\$491	\$246	n/a
GRT7TP	36 x 84 x 1	100	85	8.75	\$572	\$287	n/a
GRT8TP	36 x 96 x 1	92.5	94	9	\$626	\$314	n/a

GRC5NTP	30 x 60 x 1	85	52	3.75	\$400	\$200	n/a
GRC5NHTP	30 x 66 x 1	65	56	2.44	\$404	\$182	n/a
GRC6NTP	30 x 72 x 1	100	57	6.50	\$434	\$218	n/a
GRC7NTP	30 x 84 x 1	100	68	7.50	\$541	\$271	n/a
GRC8NTP	30 x 96 x 1	100	76	8.50	\$590	\$295	n/a
GRC5TP	36 x 60 x 1	92.5	70	6.60	\$410	\$185	n/a
GRC5HTP	36 x 66 x 1	92.5	79	7.21	\$432	\$195	n/a
GRC6TP	36 x 72 x 1	100	71	7.50	\$500	\$251	n/a
GRC7TP	36 x 84 x 1	92.5	81	7.75	\$583	\$292	n/a
GRC8TP	36 x 96 x 1	92.5	91	9	\$638	\$320	n/a

GBT5NTP	30 x 60 x 1	85	52	3.75	\$400	\$200	n/a
GBT5NHTP	30 x 66 x 1	65	56	2.44	\$404	\$182	n/a
GBT6NTP	30 x 72 x 1	100	57	6.50	\$434	\$218	n/a
GBT7NTP	30 x 84 x 1	100	68	7.50	\$541	\$271	n/a
GBT8NTP	30 x 96 x 1	100	76	8.50	\$590	\$295	n/a
GBT5TP	36 x 60 x 1	92.5	70	6.60	\$410	\$185	n/a
GBT5HTP	36 x 66 x 1	92.5	79	7.21	\$432	\$195	n/a
GBT6TP	36 x 72 x 1	100	71	7.50	\$500	\$251	n/a
GBT7TP	36 x 84 x 1	100	81	8.75	\$583	\$292	n/a
GBT8TP	36 x 96 x 1	92.5	91	9	\$638	\$320	n/a

Tops feature metal inserts for ease of assembly to base. Two bases required for all top sizes listed above.

- GBTxNTP - 30" deep across center and 24" deep across ends
- GBTxTP - 36" deep across center and 28" deep across ends

BASE SIZE AND STYLE OPTIONS VALID FOR TOPS ABOVE:

Order the quantity of bases as indicated by each top size

GRB22H26	22 x 22 x 25	125	50	8.15	\$683	n/a	\$105
GRB22	22 x 22 x 28	150	55	9.33	\$636	n/a	\$105
GRB22H35	22 x 22 x 35	150	57.10	12	\$667	n/a	\$116
GRB22H41	22 x 22 x 40.5	150	58.30	14	\$678	n/a	\$121

GRB22H26 - lounge height **GRB22** - seated height **GRB22H35** - counter height **GRB22H41** - bar height

GSB19H26	18.5 x 18.5 x 25	100	47	5.61	\$734	n/a	\$96
GSB19	18.5 x 18.5 x 28	100	50	6.06	\$689	n/a	\$96
GSB19H35	18.5 x 18.5 x 35	125	51.80	7.52	\$730	n/a	\$105
GSB19H41	18.5 x 18.5 x 40.5	125	53.20	8.77	\$756	n/a	\$116

GSB19H26 - lounge height **GSB19** - seated height **GSB19H35** - counter height **GSB19H41** - bar height

Base comes fully assembled and features 0.5" adjustable glides to level on uneven surfaces. Screws included with base for attaching to appropriate top(s). Available in Black (**BLK**), Tungsten (**TUN**) or Designer White (**DWT**).

- Chrome (**CH**) and Brushed Chrome (**BCH**) are available at an upcharge.

Required Specifications

Finish

Optional Specifications

HP laminate
Chrome base

Accessories

Power block

S SWAP TABLES

TOPS 96"-144" WIDE AND BASES

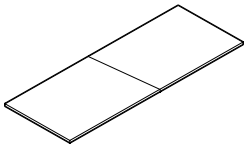

Rectangular Tops*

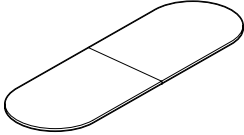

Racetrack Tops*

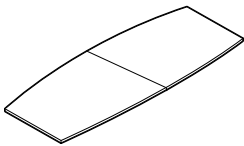

Boat Tops

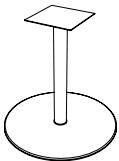

28" Dia Round Base

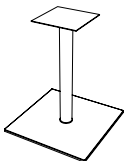

23" Square Base

MODEL#	DIMENSIONS	FREIGHT CLASS	WT/LBS.	CUBIC FT.	LIST PRICE	HP ADD	CHROME ADD
--------	------------	---------------	---------	-----------	------------	--------	------------

D x W x H

1 Piece top - 2 bases required

GRT8MTP	42 x 96 x 1	92.5	128	11.84	\$1055	\$475	n/a
GRT8WTP	48 x 96 x 1	85	190	14	\$1068	\$405	n/a

2 Piece tops - 3 bases required

GRT10WTP	48 x 120 x 1	85	220	18	\$1344	\$544	n/a
GRT12WTP	48 x 144 x 1	85	262	21.50	\$1565	\$615	n/a

1 Piece top - 2 bases required

GRC8MTP	42 x 96 x 1	92.5	128	11.84	\$1055	\$475	n/a
GRC8WTP	48 x 96 x 1	85	190	14	\$1068	\$414	n/a

2 Piece tops - 3 bases required

GRC10WTP	48 x 120 x 1	85	220	18	\$1344	\$555	n/a
GRC12WTP	48 x 144 x 1	85	262	21.50	\$1565	\$628	n/a

1 Piece top - 2 bases required

GBT8MTP	42 x 96 x 1	92.5	128	11.84	\$1055	\$475	n/a
GBT8WTP	48 x 96 x 1	85	190	14	\$1068	\$414	n/a

2 Piece tops - 3 bases required

GBT10WTP	48 x 120 x 1	85	220	18	\$1344	\$555	n/a
GBT12WTP	48 x 144 x 1	85	262	21.50	\$1565	\$628	n/a

Tops feature metal inserts for ease of assembly to base. Two bases required for one piece top. Three bases required for two piece top.

Boat tops:

- 42" deep across center and 33" deep across ends
- 48" deep across center and 38" deep across ends

BASE SIZE AND STYLE OPTIONS VALID FOR TOPS ABOVE:

Order the quantity of bases as indicated by each top size

GRB28	28 x 28 x 28	125	100	15.63	\$1096	n/a	\$116
-------	--------------	-----	-----	-------	---------------	-----	--------------

seated height

GSB23	22.5 x 22.5 x 28	100	82	9.33	\$1007	n/a	\$64
-------	------------------	-----	----	------	---------------	-----	-------------

seated height

Base comes fully assembled and features 0.5" adjustable glides to level on uneven surfaces. Screws included with base for attaching to appropriate top(s). Available in Black (BLK), Tungsten (TUN) or Designer White (DWT).

- Chrome (CH) and Brushed Chrome (BCH) are available at an upcharge.

Required Specifications

Finish

Optional Specifications

HP laminate*
Chrome base
Grommet position or power block cut-out

Accessories

Power block*

DUAL COLUMN TOPS AND BASES

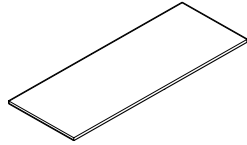

Rectangular Top*

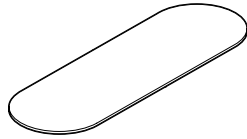

Racetrack Top*

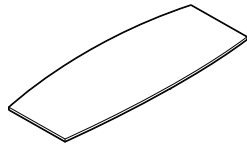

Boat Top*

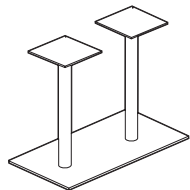

28"H Dual Column Base

MODEL#	DIMENSIONS	FREIGHT CLASS	WT/LBS.	CUBIC FT.	LIST PRICE	HP ADD	CHROME ADD
D x W x H							
GRTD5TP	36 x 60 x 1	92.5	70	6.60	\$478	\$222	n/a
GRTD5HTP	36 x 66 x 1	92.5	79	7.20	\$523	\$243	n/a
GRTD6TP	36 x 72 x 1	92.5	85	7.80	\$539	\$250	n/a
GRTD5MTP	42 x 60 x 1	92.5	83	7.60	\$531	\$246	n/a
GRTD5HMTP	42 x 66 x 1	92.5	91	8.30	\$567	\$263	n/a
GRTD6MTP	42 x 72 x 1	92.5	99	9	\$583	\$270	n/a

GRCD5TP	36 x 60 x 1	100	60	6.60	\$478	\$222	n/a
GRCD5HTP	36 x 66 x 1	100	69	7.20	\$523	\$243	n/a
GRCD6TP	36 x 72 x 1	100	75	7.80	\$539	\$250	n/a
GRCD5MTP	42 x 60 x 1	100	73	7.60	\$531	\$246	n/a
GRCD5HMTP	42 x 66 x 1	100	81	8.30	\$567	\$263	n/a
GRCD6MTP	42 x 72 x 1	100	89	9	\$583	\$270	n/a

GBTD5TP	36 x 60 x 1	100	60	6.60	\$478	\$222	n/a
GBTD5HTP	36 x 66 x 1	100	69	7.20	\$523	\$243	n/a
GBTD6TP	36 x 72 x 1	100	75	7.80	\$539	\$250	n/a
GBTD5MTP	42 x 60 x 1	100	73	7.60	\$531	\$246	n/a
GBTD5HMTP	42 x 66 x 1	100	81	8.30	\$567	\$263	n/a
GBTD6MTP	42 x 72 x 1	100	89	9	\$583	\$270	n/a

Top features metal inserts for ease of assembly to base. One dual column base required. Limited cut-out options available for power modules include A2, E2, J2, or AG2 only. Power modules corresponding to applicable cut-out codes ordered separately.

Boat tops:

- 36" wide, across center are 28" wide across ends
- 42" wide across center are 33" wide across ends

BASE SIZE AND STYLE OPTIONS VALID FOR TOPS ABOVE:

Order the quantity of bases as indicated by each top size

GDCB36H28	19 x 36 x 28	100	116.23	12.16	\$1779	n/a	\$459
-----------	--------------	-----	--------	-------	---------------	-----	--------------

seated height

Base ships knocked-down; assembly required. Features 0.5" adjustable glides to level on uneven surfaces. Screws included with base for attaching to appropriate top(s). Available in Black (**BLK**), Tungsten (**TUN**) or Designer White (**DWT**).

- Chrome (**CH**) and Brushed Chrome (**BCH**) are available at an upcharge.

Required Specifications

Finish

Optional Specifications

HP laminate*
Chrome base
Cutout for single port module*

Accessories

Single port power or USB module

S SWAP TABLES

HUDDLE TABLES OVERVIEW

D x W x H

Three heights available: seated desk height - 29", counter height - 36", bar height - 41.5" with D top, wedge, rectangular or soft ellipse shaped tops
Bring teams together to huddle, share and collaborate.

Tops include metal inserts for ease of assembly to metal base. All tops are standard with an edge scoop to help manage cables from wall mounted flat screen monitors and/or edge mounting power module (PS305057/PS305002 as an example). Support channels are included with tops over 60" wide.

Laminate kits are sold separately from metal bases for huddle tables.

Metal bases ship fully assembled and include 0.5" adjustable glides and metal screws for attaching to the top. Be sure to specify bases specific to huddle tables GRHB22Hxx or GSB19Hxx.

D-TOP HUDDLE TABLES	MODEL#	DIMENSIONS	FREIGHT CLASS	WT./LBS.	CUBIC FT.	LIST PRICE	HP ADD	CHROME ADD
---------------------	--------	------------	---------------	----------	-----------	------------	--------	------------

D x W x H

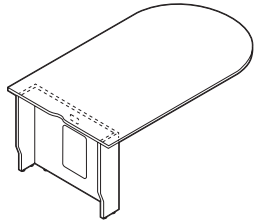

29" H D-Top Huddle

GDH364829	36 x 48 x 29	70	77.05	3.94	\$781	\$242	n/a
GDH366029	36 x 60 x 29	70	86.95	4.46	\$952	\$345	n/a
GDH367229	36 x 72 x 29	70	97	4.99	\$1062	\$411	n/a
GDH426029	42 x 60 x 29	70	99.82	5.18	\$1069	\$394	n/a
GDH427229	42 x 72 x 29	70	111.50	5.79	\$1198	\$471	n/a
GDH428429	42 x 84 x 29	92.5	123.10	11.98	\$1326	\$548	n/a
GDH429629	42 x 96 x 29	92.5	134.74	13.31	\$1433	\$612	n/a
GDH486029	48 x 60 x 29	70	112.60	5.89	\$1192	\$446	n/a
GDH487229	48 x 72 x 29	70	126	6.58	\$1334	\$532	n/a
GDH488429	48 x 84 x 29	92.5	139.24	13.50	\$1427	\$588	n/a
GDH489629	48 x 96 x 29	92.5	152.56	15	\$1544	\$658	n/a

Laminate u-base support is 8"D with 7" inside clearance to wall. Access wall through 14.5"H x 9.5"W hinged door with touch latch in front panel of u-base support. U-base includes 0.5" adjustable glides. U-base side panels are tapered at the bottom to clear most baseboards.

- Metal bases sold separately. Compatible with GRHB22H28 or GSHB19H28 only.

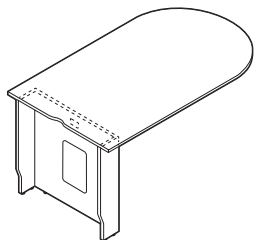

36" H D-Top Huddle

GDH364836	36 x 48 x 36	70	85.95	4.31	\$806	\$242	n/a
GDH366036	36 x 60 x 36	70	95.85	4.84	\$977	\$345	n/a
GDH367236	36 x 72 x 36	70	105.90	5.37	\$1086	\$411	n/a
GDH426036	42 x 60 x 36	70	109.82	5.61	\$1095	\$394	n/a
GDH427236	42 x 72 x 36	70	121.50	6.22	\$1224	\$471	n/a
GDH428436	42 x 84 x 36	92.5	133.10	12.41	\$1352	\$548	n/a
GDH429636	42 x 96 x 36	92.5	144.74	13.75	\$1459	\$612	n/a
GDH486036	48 x 60 x 36	70	123.60	6.38	\$1221	\$446	n/a
GDH487236	48 x 72 x 36	70	137	7.08	\$1364	\$532	n/a
GDH488436	48 x 84 x 36	92.5	150.24	14	\$1457	\$588	n/a
GDH489636	48 x 96 x 36	92.5	163.56	15.50	\$1573	\$658	n/a

Laminate u-base support is 8"D with 7" inside clearance to wall. Access wall through 14.5"H x 9.5"W hinged door with touch latch in front panel of u-base support. U-base includes 0.5" adjustable glides. U-base side panels are tapered at the bottom to clear most baseboards.

- Metal bases sold separately. Compatible with GRHB22H35 or GSHB19H35 only.

Required Specifications

Top finish
Laminate base finish

Optional Specifications

HP laminate
Grommet position or power block cut-out

Accessories

Power block

D-TOP HUDDLE TABLES

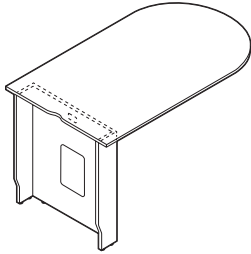

41.5"H D-Top Huddle

MODEL#	DIMENSIONS	FREIGHT CLASS	WT/LBS.	CUBIC FT.	LIST PRICE	HP ADD	CHROME ADD
D x W x H							
GDH364841	36 x 48 x 41.5	70	92.65	4.58	\$847	\$242	n/a
GDH366041	36 x 60 x 41.5	70	102.55	5.11	\$1018	\$345	n/a
GDH367241	36 x 72 x 41.5	70	112.60	5.63	\$1128	\$411	n/a
GDH426041	42 x 60 x 41.5	70	117.32	5.92	\$1143	\$394	n/a
GDH427241	42 x 72 x 41.5	70	129	6.53	\$1272	\$471	n/a
GDH428441	42 x 84 x 41.5	92.5	140.60	12.72	\$1401	\$548	n/a
GDH429641	42 x 96 x 41.5	92.5	152.24	14.06	\$1508	\$612	n/a
GDH486041	48 x 60 x 41.5	70	130.10	6.74	\$1274	\$446	n/a
GDH487241	48 x 72 x 41.5	70	143.50	7.43	\$1417	\$532	n/a
GDH488441	48 x 84 x 41.5	92.5	156.74	14.35	\$1510	\$588	n/a
GDH489641	48 x 96 x 41.5	92.5	170.06	15.85	\$1627	\$658	n/a

Laminate u-base support is 8"D with 7" inside clearance to wall. Access wall through 14.5"H x 9.5"W hinged door with touch latch in front panel of u-base support. U-base includes 0.5" adjustable glides. U-base side panels are tapered at the bottom to clear most baseboards.

- Metal bases sold separately. Compatible with GRHB22H41 or GSHB19H41 only.

Required Specifications

Top finish
Laminate base finish

Optional Specifications

HP laminate
Grommet position or power block cut-out

Accessories

Power block

S SWAP TABLES

WEDGE HUDDLE TABLES

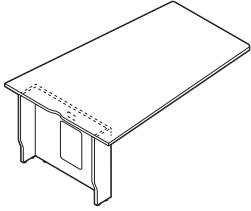

29"H Wedge Huddle

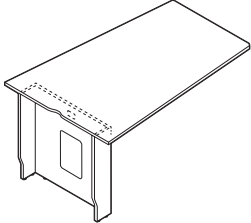

36"H Wedge Huddle

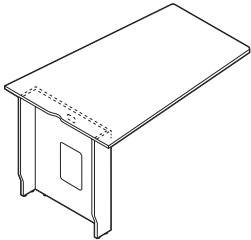

41.5"H Wedge Huddle

MODEL#	DIMENSIONS D x W x H	FREIGHT CLASS	WT./LBS.	CUBIC FT.	LIST PRICE	HP ADD	CHROME ADD
GWH486029	48 x 60 x 29	70	112.60	5.89	\$1189	\$444	n/a
GWH487229	48 x 72 x 29	70	126	6.58	\$1334	\$532	n/a
GWH488429	48 x 84 x 29	92.5	139.24	13.50	\$1427	\$588	n/a
GWH489629	48 x 96 x 29	92.5	152.56	15	\$1544	\$658	n/a

Laminate u-base support is 8"D with 7" inside clearance to wall. Access wall through 14.5"H x 9.5"W hinged door with touch latch in front panel of u-base support. U-base includes 0.5" adjustable glides. U-base side panels are tapered at the bottom to clear most baseboards.

- Metal bases sold separately. Compatible with GRHB22H28 or GSHB19H28 only.

GWH486036	48 x 60 x 36	70	123.60	6.38	\$1218	\$444	n/a
GWH487236	48 x 72 x 36	70	137	7.08	\$1364	\$532	n/a
GWH488436	48 x 84 x 36	92.5	150.24	14	\$1457	\$588	n/a
GWH489636	48 x 96 x 36	92.5	163.56	15.50	\$1573	\$658	n/a

Laminate u-base support is 8"D with 7" inside clearance to wall. Access wall through 14.5"H x 9.5"W hinged door with touch latch in front panel of u-base support. U-base includes 0.5" adjustable glides. U-base side panels are tapered at the bottom to clear most baseboards.

- Metal bases sold separately. Compatible with GRHB22H35 or GSHB19H35 only.

GWH486041	48 x 60 x 41.5	70	130.10	6.74	\$1271	\$444	n/a
GWH487241	48 x 72 x 41.5	70	143.50	7.43	\$1417	\$532	n/a
GWH488441	48 x 84 x 41.5	92.5	156.74	14.35	\$1510	\$588	n/a
GWH489641	48 x 96 x 41.5	92.5	170.06	15.85	\$1627	\$658	n/a

Laminate u-base support is 8"D with 7" inside clearance to wall. Access wall through 14.5"H x 9.5"W hinged door with touch latch in front panel of u-base support. U-base includes 0.5" adjustable glides. U-base side panels are tapered at the bottom to clear most baseboards.

- Metal bases sold separately. Compatible with GRHB22H41 or GSHB19H41 only.

Required Specifications

Top finish
Laminate base finish

Optional Specifications

HP laminate
Grommet position or power block cut-out

Accessories

Power block

RECTANGULAR HUDDLE TABLES

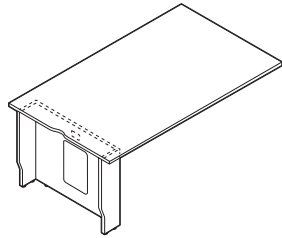

29"H Rectangular Huddle

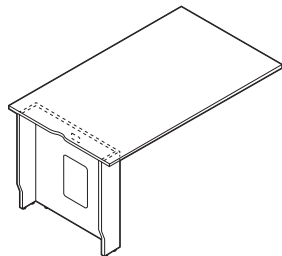

36"H Rectangular Huddle

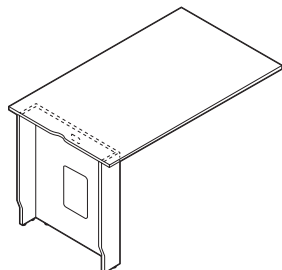

41.5"H Rectangular Huddle*

MODEL#	DIMENSIONS	FREIGHT CLASS	WT./LBS.	CUBIC FT.	LIST PRICE	HP ADD	CHROME ADD
D x W x H							
GRH364829	36 x 48 x 29	70	77.05	3.94	\$781	\$242	n/a
GRH366029	36 x 60 x 29	70	86.95	4.46	\$952	\$345	n/a
GRH367229	36 x 72 x 29	70	97	4.99	\$1062	\$411	n/a
GRH426029	42 x 60 x 29	70	99.82	5.18	\$1069	\$394	n/a
GRH427229	42 x 72 x 29	70	111.50	5.79	\$1198	\$471	n/a
GRH428429	42 x 84 x 29	92.5	123.10	11.98	\$1326	\$548	n/a
GRH429629	42 x 96 x 29	92.5	134.74	13.31	\$1433	\$612	n/a
GRH486029	48 x 60 x 29	70	112.60	5.89	\$1192	\$446	n/a
GRH487229	48 x 72 x 29	70	126	6.58	\$1334	\$532	n/a
GRH488429	48 x 84 x 29	92.5	139.24	13.50	\$1427	\$588	n/a
GRH489629	48 x 96 x 29	92.5	152.56	15	\$1544	\$658	n/a

Laminate u-base support is 8"D with 7" inside clearance to wall. Access wall through 14.5"H x 9.5"W hinged door with touch latch in front panel of u-base support. U-base includes 0.5" adjustable glides. U-base side panels are tapered at the bottom to clear most baseboards.

- Metal bases sold separately. Compatible with GRHB22H28 or GSHB19H28 only.

GRH364836	36 x 48 x 36	70	85.95	4.31	\$806	\$242	n/a
GRH366036	36 x 60 x 36	70	95.85	4.84	\$977	\$345	n/a
GRH367236	36 x 72 x 36	70	105.90	5.37	\$1086	\$411	n/a
GRH426036	42 x 60 x 36	70	109.82	5.61	\$1095	\$394	n/a
GRH427236	42 x 72 x 36	70	121.50	6.22	\$1224	\$471	n/a
GRH428436	42 x 84 x 36	92.5	133.10	12.41	\$1352	\$548	n/a
GRH429636	42 x 96 x 36	92.5	144.74	13.75	\$1459	\$612	n/a
GRH486036	48 x 60 x 36	70	123.60	6.38	\$1221	\$446	n/a
GRH487236	48 x 72 x 36	70	137	7.08	\$1364	\$532	n/a
GRH488436	48 x 84 x 36	92.5	150.24	14	\$1457	\$588	n/a
GRH489636	48 x 96 x 36	92.5	163.56	15.50	\$1573	\$658	n/a

Laminate u-base support is 8"D with 7" inside clearance to wall. Access wall through 14.5"H x 9.5"W hinged door with touch latch in front panel of u-base support. U-base includes 0.5" adjustable glides. U-base side panels are tapered at the bottom to clear most baseboards.

- Metal bases sold separately. Compatible with GRHB22H35 or GSHB19H35 only.

GRH364841	36 x 48 x 41.5	70	92.65	4.58	\$847	\$242	n/a
GRH366041	36 x 60 x 41.5	70	102.55	5.11	\$1018	\$345	n/a
GRH367241	36 x 72 x 41.5	70	112.60	5.63	\$1128	\$411	n/a
GRH426041	42 x 60 x 41.5	70	117.32	5.92	\$1143	\$394	n/a
GRH427241	42 x 72 x 41.5	70	129	6.53	\$1272	\$471	n/a
GRH428441	42 x 84 x 41.5	92.5	140.60	12.72	\$1401	\$548	n/a
GRH429641	42 x 96 x 41.5	92.5	152.24	14.06	\$1508	\$612	n/a
GRH486041	48 x 60 x 41.5	70	130.10	6.74	\$1274	\$446	n/a
GRH487241	48 x 72 x 41.5	70	143.50	7.43	\$1417	\$532	n/a
GRH488441	48 x 84 x 41.5	92.5	156.74	14.35	\$1510	\$588	n/a
GRH489641	48 x 96 x 41.5	92.5	170.06	15.85	\$1627	\$658	n/a

Laminate u-base support is 8"D with 7" inside clearance to wall. Access wall through 14.5"H x 9.5"W hinged door with touch latch in front panel of u-base support. U-base includes 0.5" adjustable glides. U-base side panels are tapered at the bottom to clear most baseboards.

- Metal bases sold separately. Compatible with **GRHB22H41** or **GSHB19H41** only.

Required Specifications

Top finish
Laminate base finish

Optional Specifications

HP laminate
Grommet position or power block cut-out

Accessories

Power block

S SWAP TABLES

SOFT ELLIPSE HUDDLE TABLES

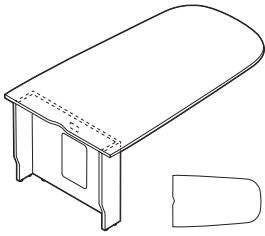

29"H Soft Ellipse Huddle

MODEL#	DIMENSIONS D x W x H	FREIGHT CLASS	WT./LBS.	CUBIC FT.	LIST PRICE	HP ADD	CHROME ADD
GSEH364829	36 x 48 x 29	70	77.05	3.94	\$781	\$242	n/a
GSEH366029	36 x 60 x 29	70	86.95	4.46	\$952	\$345	n/a
GSEH367229	36 x 72 x 29	70	97	4.99	\$1062	\$411	n/a
GSEH426029	42 x 60 x 29	70	99.82	5.18	\$1069	\$394	n/a
GSEH427229	42 x 72 x 29	70	111.50	5.79	\$1198	\$471	n/a
GSEH428429	42 x 84 x 29	92.5	123.10	11.98	\$1326	\$548	n/a
GSEH429629	42 x 96 x 29	92.5	134.74	13.31	\$1433	\$612	n/a
GSEH486029	48 x 60 x 29	70	112.60	5.89	\$1192	\$446	n/a
GSEH487229	48 x 72 x 29	70	126	6.58	\$1334	\$532	n/a
GSEH488429	48 x 84 x 29	92.5	139.24	13.50	\$1427	\$588	n/a
GSEH489629	48 x 96 x 29	92.5	152.56	15	\$1544	\$658	n/a

Laminate u-base support is 8"D with 7" inside clearance to wall. Access wall through 14.5"H x 9.5"W hinged door with touch latch in front panel of u-base support. U-base includes 0.5" adjustable glides. U-base side panels are tapered at the bottom to clear most baseboards.

- Metal bases sold separately. Compatible with **GRHB22H28** or **GSHB19H28** only.

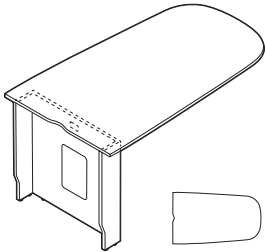

36"H Soft Ellipse Huddle

GSEH364836	36 x 48 x 36	70	85.95	4.31	\$806	\$242	n/a
GSEH366036	36 x 60 x 36	70	95.85	4.84	\$977	\$345	n/a
GSEH367236	36 x 72 x 36	70	105.90	5.37	\$1086	\$411	n/a
GSEH426036	42 x 60 x 36	70	109.82	5.61	\$1095	\$394	n/a
GSEH427236	42 x 72 x 36	70	121.50	6.22	\$1224	\$471	n/a
GSEH428436	42 x 84 x 36	92.5	133.10	12.41	\$1352	\$548	n/a
GSEH429636	42 x 96 x 36	92.5	144.74	13.75	\$1459	\$612	n/a
GSEH486036	48 x 60 x 36	70	123.60	6.38	\$1221	\$446	n/a
GSEH487236	48 x 72 x 36	70	137	7.08	\$1364	\$532	n/a
GSEH488436	48 x 84 x 36	92.5	150.24	14	\$1457	\$588	n/a
GSEH489636	48 x 96 x 36	92.5	163.56	15.50	\$1573	\$658	n/a

Laminate u-base support is 8"D with 7" inside clearance to wall. Access wall through 14.5"H x 9.5"W hinged door with touch latch in front panel of u-base support. U-base includes 0.5" adjustable glides. U-base side panels are tapered at the bottom to clear most baseboards.

- Metal bases sold separately. Compatible with **GRHB22H35** or **GSHB19H35** only.

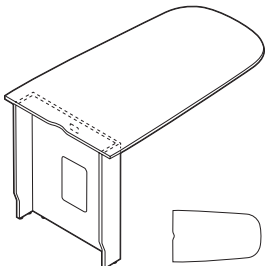

41.5"H Soft Ellipse Huddle*

GSEH364841	36 x 48 x 41.5	70	92.65	4.58	\$847	\$242	n/a
GSEH366041	36 x 60 x 41.5	70	102.55	5.11	\$1018	\$345	n/a
GSEH367241	36 x 72 x 41.5	70	112.60	5.63	\$1128	\$411	n/a
GSEH426041	42 x 60 x 41.5	70	117.32	5.92	\$1143	\$394	n/a
GSEH427241	42 x 72 x 41.5	70	129	6.53	\$1272	\$471	n/a
GSEH428441	42 x 84 x 41.5	92.5	140.60	12.72	\$1401	\$548	n/a
GSEH429641	42 x 96 x 41.5	92.5	152.24	14.06	\$1508	\$612	n/a
GSEH486041	48 x 60 x 41.5	70	130.10	6.74	\$1274	\$446	n/a
GSEH487241	48 x 72 x 41.5	70	143.50	7.43	\$1417	\$532	n/a
GSEH488441	48 x 84 x 41.5	92.5	156.74	14.35	\$1510	\$588	n/a
GSEH489641	48 x 96 x 41.5	92.5	170.06	15.85	\$1627	\$658	n/a

Laminate u-base support is 8"D with 7" inside clearance to wall. Access wall through 14.5"H x 9.5"W hinged door with touch latch in front panel of u-base support. U-base includes 0.5" adjustable glides. U-base side panels are tapered at the bottom to clear most baseboards.

- Metal bases sold separately. Compatible with **GRHB22H41** or **GSHB19H41** only.

Required Specifications

Top finish
Laminate base finish

Optional Specifications

HP laminate
Grommet position or power block cut-out

Accessories

Power block

HUDDLE BASES

MODEL# DIMENSIONS FREIGHT CLASS WT/LBS. CUBIC FT. LIST PRICE HP ADD CHROME ADD

D x W x H

SELECT BASE COMPATIBLE WITH TOP HEIGHT:

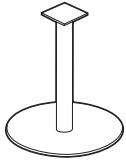

22" Round Huddle Base

GRHB22H28	22 x 22 x 28	92.5	10	1	\$766	n/a	\$96
GRHB22H35	22 x 22 x 35	150	62	12.67	\$766	n/a	\$116
GRHB22H41	22 x 22 x 40.5	150	63	14.17	\$800	n/a	\$121

GRHB22H28 - seated height **GRHB22H35** - counter height **GRHB22H41** - bar height

Metal base ships fully assembled. Features 0.5" adjustable glides to level on uneven surfaces. Screws included with base for attaching to appropriate huddle table laminate pieces. Available in Black (**BLK**), Tungsten (**TUN**) or Designer White (**DWT**). Be sure to double check huddle table laminate pieces and metal bases are correct corresponding heights.

- Chrome (**CH**) and Brushed Chrome (**BCH**) are available at an upcharge.

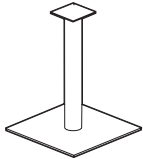

18.5" Square Huddle Base

GSHB19H28	18.5 x 18.5 x 28	125	55	6.94	\$819	n/a	\$105
GSHB19H35	18.5 x 18.5 x 35	125	57	8.80	\$819	n/a	\$105
GSHB19H41	18.5 x 18.5 x 40.5	150	58	9.84	\$858	n/a	\$116

GSHB19H28 - seated height **GSHB19H35** - counter height **GSHB19H41** - bar height

Metal base ships fully assembled. Features 0.5" adjustable glides to level on uneven surfaces. Screws included with base for attaching to appropriate huddle table laminate pieces. Available in Black (**BLK**), Tungsten (**TUN**) or Designer White (**DWT**). Be sure to double check huddle table laminate pieces and metal bases are correct corresponding heights.

- Chrome (**CH**) and Brushed Chrome (**BCH**) are available at an upcharge.

Required Specifications

Finish

Optional Specifications

Chrome base



Terina is a simple flip top table series that transforms any space into sophisticated areas for training, meetings and collaboration. Terina features unique and elegant aluminum, angled t-leg design paired with high pressure laminate or veneer surface, with optional modesty panels. Surface power modules offer an easy way to charge electronic devices without the need to drop down cords. Wires are managed below the worksurface with snap-in cable clips. Terina can be ganged together with optional flush ganging plates. Single hand release mechanism is active from the center of the user side of the table. Tables can be nested together in an upright position to minimize storage space.



Features and Benefits

- Training, meeting or conferencing. A multi-purpose table that allows you quickly and simply adapt your space to suit your needs.
- Simple flip top mechanism designed for single handed operation.
- Tops offered in high pressure laminate or wood veneer
- 10" modesty panel articulates when tables fold down
- Legs and crossbeam offered in 7 paint finishes
- Optional flush ganging plates
- Tables can be nested together when not in use.

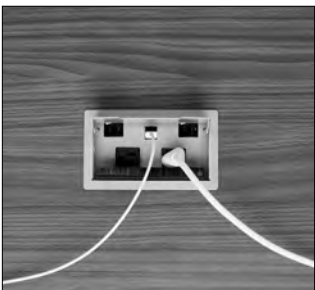

Optional power block includes power and data

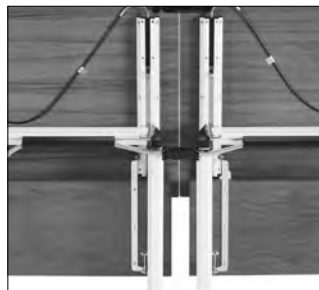

Optional ganging plates and daisy chain power management



Tables can be nested together when not in use.

GENERAL INFORMATION

- Terina flip top tables transform any space into sophisticated areas for training, meetings and collaboration.
- Simple flip top mechanism is designed for one handed operation.
- Unique, angled “T” leg design.
- Shipped R.T.A. (Ready to Assemble).
- Global laminate products are in compliance with stringent emission guidelines set out by the Greenguard Environmental Institute under the standards for low emitting products and materials. www.greenguard.org.
- **Level 3 Certified**

WORKSURFACES

- Laminate surfaces are 1-1/16” thick tops constructed of 45 lb. density particle board with high pressure laminate and finished on the underside of the surface with a kraft paper backing.
- Veneer surfaces are 1-3/16” thick tops constructed of 45 lb. density particle board and are balanced on the underside with veneer (unfinished)
- Worksurfaces are pre-drilled for alignment of the Terina base

BASE

- Tables feature an aluminum leg, cross beam and die-cast foot.
- Legs and cross beam are available in (7) different finish options.
- Die-cast foot is always in polished aluminum finish.
- Foot span is 23”

EDGING

- Laminate surfaces offer a selection of matching + coordinated edgeband. Specify separately from the surface finish.
- Veneer tops are finished with a 6mm hardwood edge, stained to match

CASTERS

- Casters are standard on all tables.
- 2-3/8” dual wheel casters with manual lock. Full 360° swivel.
- Suggested for carpeted surfaces.
- Available in grey only

GANGING PLATES

- Ganging plates are available for ganging adjoining tables together.
- Ganging plates are black epoxy coated steel plates with two thumbscrews

WIRE MANAGEMENT

- Wire management option is a snap-in channel that fits on the interior of the leg or on the underside of the flip-top cross beam

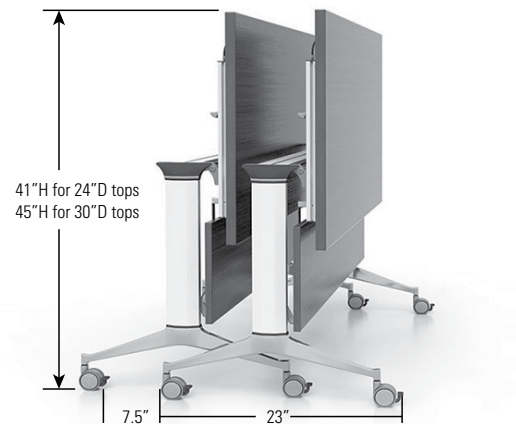
FLIP TOP TABLE NESTING DIAGRAM**MODESTY PANELS**

- 10” modesty panel affixes to the top and base, articulating when it folds down.
- Available in all standard laminates
- Modesty panels up to 60”w have vertical grain. Modesty panels 66” and wider will have horizontal grain.

LAMINATE FINISHES

ACJ	Absolute Acajou	HGT	Hayden Grey
ASN	Asian Night	QTM	Quartered Mahogany
AWC	Avant Cherry	SOG	Storm Grey
AWH	Avant Honey	TFW	Tiger Fruitwood
BLK	Black	TWL	Tiger Walnut
BRC	Brushed Cobalt	WHE	Walnut Heights
CMB	Clear Maple	WHC	White Chocolate
DES	Dark Espresso	WCR	Winter Cherry
DWT	Designer White	WGY	Willow Grey

EDGE FINISHES (Laminate Surfaces Only)

AAE	Absolute Acajou	DWE	Designer White
ASE	Asian Night	QTM	Quartered Mahogany
ACE	Avant Cherry	TPE	Taupe (use w/HGT)
AHE	Avant Honey	TFE	Tiger Fruitwood
BLK	Black	TWE	Tiger Walnut
BRC	Brushed Cobalt	WHE	Walnut Heights
CHR	Charcoal (use w/SOG)	CBE	White Chocolate
CME	Clear Maple	WCE	Winter Cherry
DEE	Dark Espresso		

LEG FINISHES

BLK	Black	CHR	Charcoal
DWT	Designer White	NEV	Nevada
SIL	Silver	TPE	Taupe
TUN	Tungsten		

VENEER FINISHES:

Code	Finish	Veneer Type	Cut
AMW	Almond Cherry	Cherry	Flat Sliced
BAMC	Caramel Bamboo	Bamboo	Narrow
CAW	Cocoa Walnut	Walnut	Flat Sliced
CRW	Coral	White Oak	Rift
DCW	Dark Cherry	Cherry	Flat Sliced
EWV	Espresso Walnut	Walnut	Flat Sliced
EVV	Evening Oak	White Oak	Rift
GRW	Grey on Oak	White Oak	Rift
HAW	Hazelnut	Maple	Flat Sliced
SMW	Honey Maple	Maple	Flat Sliced
JAW	Java	White Oak	Rift
LTW	Latte Walnut	Walnut	Flat Sliced
MTW	Milestone	White Oak	Rift
MCW	Mocha	White Oak	Rift
MPW	Natural Maple	Maple	Flat Sliced
RCW	Red Cherry	Cherry	Flat Sliced
VNW	Vintage Cherry	Cherry	Flat Sliced
WLW	Walnut	Walnut	Flat Sliced
WCW	Warm Cherry	Cherry	Flat Sliced
WMW	White Maple	Maple	Flat Sliced

SPECIFY OPTIONS

GROMMETS

- Grommets are available in all tops (left, center or right). Order as: **AG1, AG2 or AG3. Add \$69.**
- Grommet hole dimensions are 3 1/4" wide x 1 7/8" deep.
- Available on all table widths and depths
- Please note limited user space when cutouts are specified. See dimensions on diagram below.**

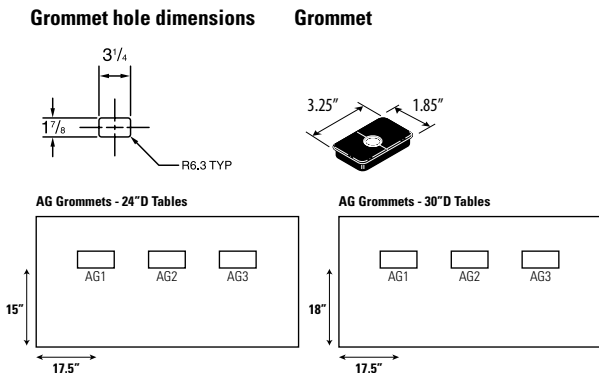

- Grommets may be placed at non-standard locations. Order as: **AGS - Add \$69.** A drawing must be supplied with vertical and horizontal dimensions to the center of the cut-out (as in drawing above). Please refer to CUSTOM GROMMET LOCATION FORM in the back reference section.

POWER BLOCK

- A Power Block (model **PMSPDM**) may be ordered on all worksurfaces.
- A Power Block is a rectangular worksurface power/data module with one electrical duplex receptacle and two data (RJ45) receptacles. 9' black cord included. Power Block dimensions are 3 1/2" deep x 6 1/2" wide x 2 3/4" high.
- A Power Block cutout (for model **PMSPDM**) may be ordered for **tops 60" and up in any standard location.** Order as **E1, E2 or E3. Add \$69.**
- A Power Block cutout (for model **PMSPDM**) may be ordered in the **center position**

only for **48" and 54" tops.** Order as **E2. Add \$69.**

- To purchase a Power Block, you must specify both the Power Block cut-out location and the Power Block model #. Order Power Block as **PMSPDM, Add \$261.**
- Please note limited user space when cutouts are specified. See dimensions on diagram below.**

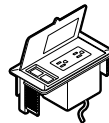

Power Block **PMSPDM, Add \$261**

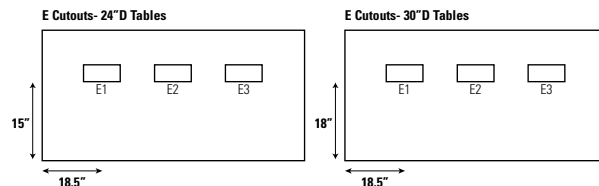

VILLA CUTOUTS

- A Villa cutout may be ordered for **tops 60" and up in any standard location.** Order as: **V1, V2 or V3 - Add \$69 for each cutout.**
- A Villa cutout may be ordered in the **center position only** for **48" and 54" tops.** Order as: **V2 - Add \$69.**
- Villa with USB is not compatible with Terina tables**
- Please note limited user space when cutouts are specified. See dimensions on diagram below.**

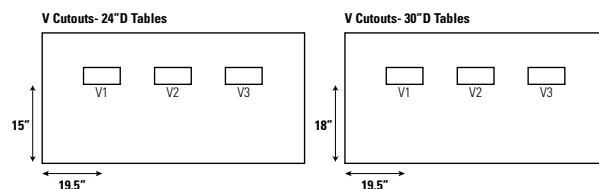

RECTANGULAR TABLES



Rectangular Table - Laminate Top*

MODEL# DIMENSIONS FREIGHT CLASS WT/LBS. CUBIC FT. LIST PRICE

D x W x H

GFT2472R	24 x 72 x 29	100	66	7	\$1339
GFT2466R	24 x 66 x 29	100	61	7	\$1313
GFT2460R	24 x 60 x 29	125	55	7	\$1291
GFT2454R	24 x 54 x 29	100	53	6	\$1261
GFT2448R	24 x 48 x 29	100	48	6	\$1155
GFT3072R	30 x 72 x 29	100	68	7	\$1381
GFT3066R	30 x 66 x 29	100	66	7	\$1365
GFT3060R	30 x 60 x 29	100	61	7	\$1345
GFT3054R	30 x 54 x 29	100	55	6	\$1313
GFT3048R	30 x 48 x 29	100	53	6	\$1233

Tables feature a flip-top **laminate** worksurface for ease of storage. Single hand release mechanism is active from the center of the user side of the table. Leg can be painted in a variety of finishes. Foot is always in polished aluminum. Each table can be ganged together with GNCNGFP ganging plates (see next page). Modesty panels are available (see GFTxxM).

- Casters are available in grey only.



Rectangular Table - Veneer Top

GFT2472RV	24 x 72 x 29	100	66	7	\$2224
GFT2466RV	24 x 66 x 29	100	61	7	\$2114
GFT2460RV	24 x 60 x 29	125	55	7	\$2004
GFT2454RV	24 x 54 x 29	100	53	6	\$1942
GFT2448RV	24 x 48 x 29	100	48	6	\$1876
GFT3072RV	30 x 72 x 29	100	68	7	\$2558
GFT3066RV	30 x 66 x 29	100	66	7	\$2418
GFT3060RV	30 x 60 x 29	100	61	7	\$2277
GFT3054RV	30 x 54 x 29	100	55	6	\$2132
GFT3048RV	30 x 48 x 29	100	53	6	\$1990

Tables feature a flip-top **veneer** worksurface for ease of storage. Single hand release mechanism is active from the center of the user side of the table. Leg can be painted in a variety of finishes. Foot is always in polished aluminum. Each table can be ganged together with GNCNGFP ganging plates (see next page). Modesty panels are available (see GFTxxMx).

- Casters are available in grey only.

Required Specifications

Top finish
Leg finish
Edge finish*

Optional Specifications

Grommet

Accessories

Power block
Wire management
Ganging plate

MODESTY PANELS

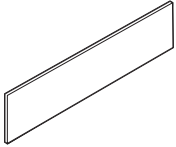

Modesty Panel - Laminate*

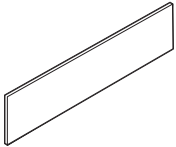

Modesty Panel - Veneer

MODEL# DIMENSIONS FREIGHT CLASS WT/LBS. CUBIC FT. LIST PRICE

D x W x H

GFT72M	.75 x 70 x 10	92.5	20	2	\$242
GFT66M	.75 x 64 x 10	100	18	2	\$231
GFT60M	.75 x 58 x 10	70	15	1	\$221
GFT54M	.75 x 52 x 10	85	13	1	\$212
GFT48M	.75 x 46 x 10	92.5	11	1	\$201

Laminate modesty panel for use on GFTxxxxR Tables. Articulating modesty panel includes necessary hardware to attach. Can be retrofitted.

- Modesty panels up to 60" w have vertical grain. Modesty panels 66" and wider will have horizontal grain.

GFT72MV	.75 x 70 x 10	92.5	20	2	\$679
GFT66MV	.75 x 64 x 10	100	18	2	\$631
GFT60MV	.75 x 58 x 10	70	15	1	\$573
GFT54MV	.75 x 52 x 10	85	13	1	\$515
GFT48MV	.75 x 46 x 10	92.5	11	1	\$467

Veneer modesty panel for use on GFTxxxxRx Tables. Articulating modesty panel includes necessary hardware to attach. Can be retrofitted.

- Modesty panels up to 60" w have vertical grain. Modesty panels 66" and wider will have horizontal grain.

Required Specifications

Finish
Edge finish*

WIRE MANAGEMENT

MODEL# DIMENSIONS FREIGHT CLASS WT/LBS. CUBIC FT. LIST PRICE



Wire Manager

	D x W x H				
GFTCM04BLK	2 x 10 x 2	70	1	1	\$37

Set of four, 10" long grey plastic extrusions. Can be snapped into the inside of each leg for wire management from the surface to the floor, or snapped into the cross beam of the table to keep wires tucked neatly below the worksurface.

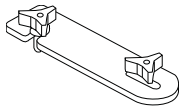

Ganging Flush Plate

GFCNGFP	.1 x 5 x 2.5	70	1	.01	\$37
---------	--------------	----	---	-----	-------------

Black epoxy coated steel plates with 2 thumbscrews included. Used to connect worksurfaces together. Holes with steel inserts are located in the corner of the tops to accommodate this plate. Sold individually.



Zook was designed for today's dynamic and diverse learning environments. The tables are lightweight and can be reconfigured easily to create interactive environments and support collaboration.

Choose from a variety of organic and geometric shaped table tops to optimize flexibility. They are available in a wide array of sizes and finishes in both thermally fused laminate and high pressure laminate. Zook's color palette also includes nine new bold finishes available in high pressure laminate only.

Tops are available in 1" thick thermally fused laminate or 1-1/16" high pressure laminate with Global's preferred matching edge or a new optional ergo friendly edge.



Features and Benefits

- Tops are 1" thick thermally fused laminate or 1-1/16" high pressure laminate.
- Tops are constructed of 45 lb. density particle board.
- Global's preferred matching edge or optional ergo friendly edge.
- Tops are available in organic and geometric shapes.
- Surfaces include factory installed metal inserts for solid and secure leg connections.
- Group table's cable tower is constructed from thermally fused laminate with a removable access panel and inside clearance of 9" x 9". Available on group tables ZK44848P, ZK45959P and ZK65990 only.
- Easy to assemble



Variety of organic and geometric shapes



Multiple table configurations. Ideal for group study and encouraging collaboration.

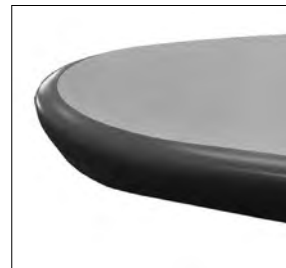

Optional ergo friendly edge

GENERAL INFORMATION

- Zook is a series of tables designed for classrooms and diverse learning environments.
- Organic shapes and rectangular tops are available to create a variety of configurations that naturally bring people together.
- Choose from Zook group tables for groups of 4 to 6 people comfortably, pod tables for individuals, activity tables, or flip top tables.
- Create spaces that encourage discussion and the sharing of ideas
- Supports multi-use, active learning spaces and a variety of teaching styles
- Materials and workmanship stand up to the rigorous demands of today's learning environments
- Shipped easy to assemble. Tops include factory installed metal inserts to accept leg attachment.
- For environmental certifications, please visit globalfurnituregroup.com.

WORKSURFACES

- Tops are available in 1" thick thermally fused laminate or 1 1/16" thick high pressure laminate
- Available in many finishes in both thermally fused laminate or high pressure laminate. Color palette also includes new bold finishes available in high pressure laminate only.

CONSTRUCTION

- Tops core is made of 45 lb. density particleboard
- Surfaces include factory-installed metal inserts for solid and secure leg connections

EDGE DETAIL

- Global's preferred matching edge is standard
- Optional ergo-friendly edge is available at an upcharge (varies by item; see product for details).
- Rectangular tops feature rounded 2.5" radius corners



Ergo friendly edge



2mm flat edge

LEGS

- Group tables have 3" diameter steel post legs and are 28" high with adjustable 3" diameter plastic glides. Each leg includes a 6" x 6" metal top plate, truss head screws included. Available in Black (**BLK**), Designer White (**DWT**) or Tungsten (**TUN**) painted finishes; sandtex texture.
- Pod tables have 1.5" diameter tube steel legs on adjustable levelers or dual wheel locking casters. Each leg includes top plate for mounting, truss head screws included. Optional Chrome (**CHM**) finish is available for pod tables only:
Add \$59 for three-legged models
Add \$78 for four-legged models
- Activity tables have a 2" diameter tapered leg on adjustable levelers or optional locking casters. Each leg includes top plate and hardware for mounting. Available in Black (**BLK**), Designer White (**DWT**) or Tungsten (**TUN**) painted finishes; sandtex texture, and Chrome (**CHM**).

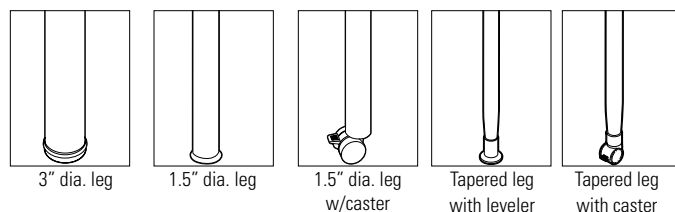

3" dia. leg

1.5" dia. leg

1.5" dia. leg w/caster

Tapered leg with leveler

Tapered leg with caster

CASTERS

- Pod table models ending in C indicate legs equipped with 2" dia locking casters. Casters are black only.
- Activity table models ending in C indicate legs equipped with 2" dia locking casters. Casters are black only.

GROUP TABLE CABLE TOWER

- Constructed from thermally fused laminate with a removable access panel and an inside clearance of 9" x 9".
- Ideal for access to floor monuments. Available on group tables ZK44848P, ZK45959P and ZK65990P only.
- Must specify cut-out option when ordering group tables to accommodate select power module. Power modules sold separately.
- Available in Black (BLK), Brushed Cobalt (BRC) or Designer White (DWT) finish

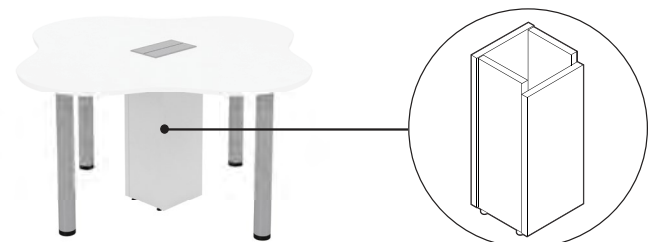

Cable tower

ZOOK FLIP-TOP TABLES

- Available in three sizes, 30"w x 22"d with concave shaped top; 30"w x 24"d and 60"w x 24"d rectangular top with radius corners.
- Supported by Y legs, equipped with smooth glide locking casters in Tungsten (**TUN**) only.
- 60"w tables optional with A1, A2, A3 grommet
- Modesty panels are available separately in Tungsten finish only.

OPTIONAL CUT-OUTS

Applicable for tables ZK45959P and ZK65990P

- A2 - for power modules PLCTM101B/T, ordered separately
- J2 - for power modules PLCTM102B/T, ordered separately
- K2 - for power modules PLRTM101B/T or PM101USBB/T ordered separately
- U2 - for power modules PLRTM202B/T or PM202USB/T ordered separately

1. SPECIFY MODEL NUMBER

2. SPECIFY TOP FINISH

Thermally Fused and High Pressure Laminate Finishes:

ACJ	Absolute Acajou	HGT	Hayden Grey
ASN	Asian Night	QTM	Quartered Mahogany
AWC	Avant Cherry	SOG	Storm Grey
AWH	Avant Honey	TFW	Tiger Fruitwood
BLK	Black	TWL	Tiger Walnut
BRC	Brushed Cobalt	WHE	Walnut Heights
CMB	Clear Maple	WHC	White Chocolate
DES	Dark Espresso	WCR	Winter Cherry
DWT	Designer White	WGY	Willow Grey

High Pressure Laminate Finishes** (optional - upcharge applies):

BTT	Blue Titanium	KKW	Kool Kiwi
BBY	Blueberry	LBR	Liberty Red
CBB	Caribbean Blue	MYL	Morning Yellow
FJT	Fiji Teal	RPL	Royal Purple
FPY	Fresh Papaya		

**select edge finish separately from above (see step #3).

Upcharge varies for high pressure laminate by product. Refer to products for details.

3. SPECIFY EDGE FINISH

2mm Thick Edgebanding:

ACJ	Absolute Acajou	HGT	Hayden Grey
ASN	Asian Night	QTM	Quartered Mahogany
AWC	Avant Cherry	SOG	Storm Grey
AWH	Avant Honey	TFW	Tiger Fruitwood
BLK	Black	TWL	Tiger Walnut
BRC	Brushed Cobalt	WHE	Walnut Heights
CMB	Clear Maple	WHC	White Chocolate
DES	Dark Espresso	WCR	Winter Cherry
DWT	Designer White	WGY	Willow Grey

Ergo Friendly Edge Finishes (optional - upcharge applies)

EBL	Black
ECP	Cappuccino
ECG	Charcoal Grey
EDW	Designer White
EGR	Grey

4. SPECIFY LEG FINISH

Legs:

BLK	Black*
DWT	Designer White* (not available on activity tables)
TUN	Tungsten*
CHM	Chrome (for pod and activity tables only)

*Painted Sandtex finish

Note: Leg finish is not optional for flip-top tables. Available in Tungsten only.

5. SPECIFY CABLE TOWER FINISH - ZK44848P, ZK45959P AND ZK65990P ONLY

Cable Tower Finishes:

BLK	Black
BRC	Brushed Cobalt
DWT	Designer White

6. SPECIFY CUT-OUT OPTION - REMEMBER TO ORDER POWER MODULE SEPARATELY

POWER BLOCK AND CUT-OUT OPTIONS

- A power block delivers power/data to the table surface.
- Power block modules must be ordered separately and available for models ZK44848P, ZK45959P and ZK65990P only.
- Must specify the power block cut-out option when ordering the table.
- Optional cut-out available in the **center position** only and corresponds to select power modules. Order as **K2** or **U2**, depending on the power module ordered - Add \$65.
- For a custom size cut-out (must be in center position), please contact Customer Care
- Select power block option on page 720.

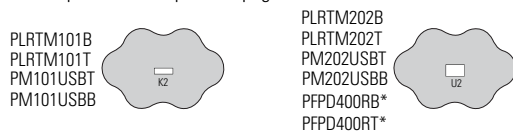

* Most recommended

- Match power block desired with cut-out code and location from above grid
- Example: For power block module # PLRTM101B, specify cut-out option K2.

EXAMPLE ZOOK ORDER CODES:

Group table

ZK65590P	-ACJ	-HPL	-ECG	-TUN	-BRC	-U2
Model #	Top finish	High pressure laminate	Ergo friendly edge and finish	Leg finish	Cable tower finish	Cut out option

Pod table

ZK412529L	-ACJ	-HPL	-WHT	-TUN
Model #	Top finish	High pressure laminate	2mm edge finish	Leg finish

4 TO 6-PERSON GROUP TABLES

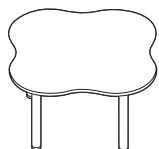

4-Person Table

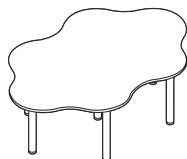

6-Person Table

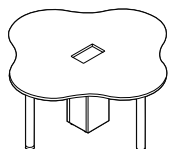

4-Person Table w/Cable Tower*

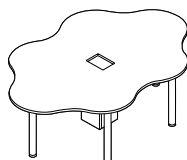

6-Person Table w/Cable Tower*

MODEL #	DIMENSIONS	FREIGHT CLASS	WT/LBS.	CUBIC FT.	LIST PRICE	HP ADD	ERGO EDGE
---------	------------	---------------	---------	-----------	------------	--------	-----------

	D x W x H						
ZK44848	48 x 48 x 29	60	215	7.10	\$848	\$231	\$70
ZK45959	59 x 59 x 29	65	220	9.20	\$872	\$273	\$149

4-person table includes top and four steel post legs. Top includes factory installed metal inserts for solid and secure leg connections. Legs are 3" in diameter x 28" high each with an adjustable 3" diameter plastic glide and a 6" x 6" metal top plate. Shipped easy to assemble in 5 cartons.

ZK65990	59 x 90 x 29	70	245	13.43	\$1348	\$480	\$222
---------	--------------	----	-----	-------	---------------	--------------	--------------

6-person table includes top and six steel post legs. Top includes factory installed metal inserts for solid and secure leg connections. Legs are 3" in diameter x 28" high each with an adjustable 3" diameter plastic glide and a 6" x 6" metal top plate. Shipped easy to assemble in 7 cartons.

ZK44848P	48 x 48 x 29	65	265	8.86	\$1157	\$231	\$70
ZK45959P	59 x 59 x 29	65	270	10.96	\$1181	\$273	\$149

4-person table includes top, four steel post legs and cable tower. Top includes factory installed metal inserts for solid and secure leg connections. Legs are 3" in diameter x 28" high each with an adjustable 3" diameter plastic glide and a 6" x 6" metal top plate. Shipped easy to assemble in 6 cartons. For power block options, see page 720.

ZK65990P	59 x 90 x 29	70	295	15.28	\$1596	\$480	\$222
----------	--------------	----	-----	-------	---------------	--------------	--------------

6-person table includes top, six steel post legs and cable tower. Top includes factory installed metal inserts for solid and secure leg connections. Legs are 3" in diameter x 28" high with an adjustable 3" diameter plastic glide and a 6" x 6" metal top plate. Shipped easy to assemble in 7 cartons. For power block options, see page 720.

Required specifications

Top finish
Edge finish
Leg finish

Optional specifications

HP laminate
Ergo friendly edge and finish
Power block cut-out*

Accessories

Power block*

POWER / DATA - RECOMMENDED FOR GROUP TABLES

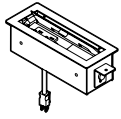

Voice/Data Block

MODEL #	DIMENSIONS D x W x H	FREIGHT CLASS	WT/LBS.	CUBIC FT.	LIST PRICE
PLRTM101B	11 x 4.3 x 3.5	125	4.65	0.67	\$411
PLRTM101T	11 x 4.3 x 3.5	125	4.65	0.67	\$411

Power module with recessed door. Power only included, specify telecom options separately. Includes one duplex outlet on top (two receptacles) and one simplex on the bottom. 10' cord. Includes one telecom knockout. Available in Black (**B**) and Tungsten (**T**) - indicated by last letter of model number. Use with Zook tables ZK44848P, ZK45959P or ZK65990P - corresponding cut-out option is K2.

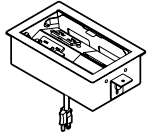

Voice/Data Block

PLRTM202B	11 x 6.8 x 3.5	92.5	7	0.67	\$477
PLRTM202T	11 x 6.8 x 3.5	92.5	7	0.67	\$477

Power only included, specify telecom options separately. Includes four simplex outlets on top and one on bottom. 10' cord. Includes two telecom knockouts. Available in Black (**B**) and Tungsten (**T**) - indicated by last letter of model number. Surface access door. Cut-out option U1, U2 or U3 to be specified when ordering. Available on Zira Boardroom tables only.

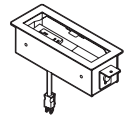

Power/USB Block

PM101USBB	11 x 4.3 x 3.5	70	6	0.3	\$506
PM101USBT	11 x 4.3 x 3.5	70	6	0.3	\$506

Power module with recessed door. Includes one power simplex - one receptacle, one USB simplex (USB charging), one telecom knockout (specify telecom options separately) and one simplex on the bottom. 10' power cord. Box available in Black (**B**) or Tungsten (**T**) as indicated by last character of model number. Simplex White finish only. Use with Zook tables ZK44848P, ZK45959P or ZK65990P - corresponding cut-out option is K2.

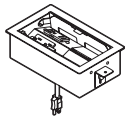

Power/USB Block

PM202USBB	11 x 6.8 x 3.5	92.5	7	0.67	\$669
PM202USBT	11 x 6.8 x 3.5	92.5	7	0.67	\$669

Power module with recessed doors. Includes one duplex with two power receptacles, one duplex with one power and two USB charging por, two telecom knockouts and one simplex on the bottom. 10' power cord. Box available in Black (**B**) or Tungsten (**T**) as indicated by last character of model number. Duplexes White finish only. Use with Zook tables ZK44848P, ZK45959P or ZK65990P - corresponding cut-out option is U2.

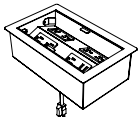

Power/USB Block

PFPD400RB	11.02 x 6.77 x --	92.5	7	0.67	\$683
PFPD400RT	11.02 x 6.77 x --	92.5	7	0.67	\$683

Power module with recessed doors. Includes two power duplexes and two USB duplexes (each with two USB ports and one outlet) on top and one simplex on the bottom. Total of six power outlets and four USB charging ports on top. 10' power cord. Box available in Black (**B**) or Tungsten (**T**) as indicated by last character of model number. Duplexes White finish only. Use with Zook tables ZK44848P, ZK45959P or ZK65990P - corresponding cut-out option is U2.

POD TABLES **MODEL#** **DIMENSIONS** **FREIGHT CLASS** **WT./LBS.** **CUBIC FT.** **LIST PRICE** **HP ADD** **ERGO EDGE**

Sample pod table configurations

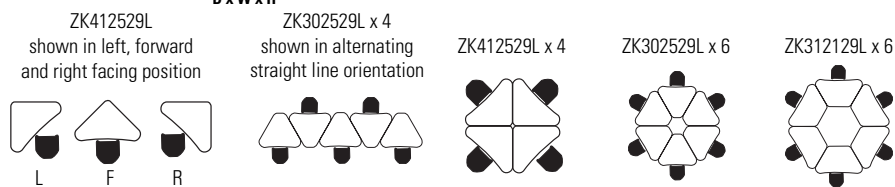

POD TABLES - 29" HIGH **MODEL#** **DIMENSIONS** **FREIGHT CLASS** **WT./LBS.** **CUBIC FT.** **LIST PRICE** **HP ADD** **ERGO EDGE**



Small Pod Table w/3 Legs

ZK302529L	24.6 x 30 x 29	70	37	2	\$285	\$49	\$22
-----------	----------------	----	----	---	--------------	-------------	-------------

Triangular table with three round tube 18 gauge steel legs. Can be used individually, can alternate front-to-back in a straight row, or can be arranged in groups of six to create a round table effect. Top includes factory installed metal inserts for solid and secure leg connections. Legs are 1.5" in diameter x 28" high with adjustable levelers. Shipped easy to assemble in 4 cartons, top separate from legs; legs individually packed.



Medium Pod Table w/4 Legs

ZK352129L	20.9 x 35 x 29	70	41	2.40	\$359	\$58	\$28
-----------	----------------	----	----	------	--------------	-------------	-------------

Trapezoid table with four round tube 18 gauge steel legs. Can be used individually or can be arranged in groups of six to create a round table effect. Top includes factory installed metal inserts for solid and secure leg connections. Legs are 1.5" in diameter x 28" high with adjustable levelers. Shipped easy to assemble in 5 cartons, top separate from legs; legs individually packed.

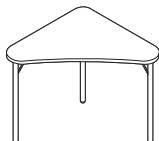

Large Pod Table w/3 Legs

ZK412529L	25.7 x 41 x 29	70	48	2.24	\$368	\$76	\$33
-----------	----------------	----	----	------	--------------	-------------	-------------

Triangular table with three round tube 18 gauge steel legs. Can be used individually or can be arranged in groups of four to create a square table effect. Top includes factory installed metal inserts for solid and secure leg connections. Legs are 1.5" in diameter x 28" high with adjustable levelers. Shipped easy to assemble in 4 cartons, top separate from legs; legs individually packed.

POD TABLES - 32" HIGH **MODEL#** **DIMENSIONS** **FREIGHT CLASS** **WT./LBS.** **CUBIC FT.** **LIST PRICE** **HP ADD** **ERGO EDGE**



Medium Pod Table w/4 Legs

ZK352132L	20.9 x 35 x 32	70	41	2.55	\$365	\$58	\$28
-----------	----------------	----	----	------	--------------	-------------	-------------

ADA compliant table with four round tube 18 gauge steel legs. Can be used individually or can be arranged in groups of six to create a round table effect. Top includes factory installed metal inserts for solid and secure leg connections. Legs are 1.5" in diameter x 31" high with adjustable levelers. Shipped easy to assemble in 5 cartons, top separate from legs; legs individually packed.

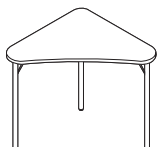

Large Pod Table w/3 Legs

ZK412532L	25.7 x 41 x 32	70	48	2.36	\$372	\$76	\$33
-----------	----------------	----	----	------	--------------	-------------	-------------

ADA compliant table with three round tube 18 gauge steel legs. Can be used individually or can be arranged in groups of four to create a square table effect. Top includes factory installed metal inserts for solid and secure leg connections. Legs are 1.5" in diameter x 31" high with adjustable levelers. Shipped easy to assemble in 4 cartons, top separate from legs; legs individually packed.

Required specifications

Top finish
Edge finish
Leg finish

Optional specifications

HP laminate
Ergo friendly edge and finish

MOBILE POD TABLES - 29" HIGH

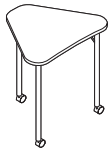

Small Mobile Pod Table w/3 Legs

MODEL#	DIMENSIONS D x W x H	FREIGHT CLASS	WT/LBS.	CUBIC FT.	LIST PRICE	HP ADD	ERGO EDGE
ZK302529C	24.6 x 30 x 29	70	37	2	\$306	\$49	\$22

Triangular table with three round tube 18 gauge steel legs. Can be used individually, can alternate front-to-back in a straight row, or can be arranged in groups of six to create a round table effect. Top includes factory installed metal inserts for solid and secure leg connections. Legs are 1.5" in diameter x 28" high with 1.5" dual wheel locking casters. Shipped easy to assemble in 4 cartons, top separate from legs; legs individually packed.

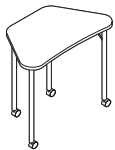

Medium Mobile Pod Table w/4 Legs

ZK352129C	20.9 x 35 x 29	70	41	2.40	\$387	\$58	\$28
-----------	----------------	----	----	------	--------------	-------------	-------------

Trapezoid table with four round tube 18 gauge steel legs. Can be used individually or can be arranged in groups of six to create a round table effect. Top includes factory installed metal inserts for solid and secure leg connections. Legs are 1.5" in diameter x 28" high with 1.5" dual wheel locking casters. Shipped easy to assemble in 5 cartons, top separate from legs; legs individually packed.

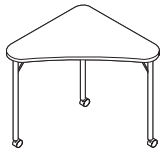

Large Mobile Pod Table w/3 Legs

ZK412529C	25.7 x 41 x 29	70	48	2.24	\$390	\$76	\$33
-----------	----------------	----	----	------	--------------	-------------	-------------

Triangular table with three round tube 18 gauge steel legs. Can be used individually or can be arranged in groups of four to create a square table effect. Top includes factory installed metal inserts for solid and secure leg connections. Legs are 1.5" in diameter x 28" high with 1.5" dual wheel locking casters. Shipped easy to assemble in 4 cartons, top separate from legs; legs individually packed.

RECTANGULAR TABLES - 29" HIGH

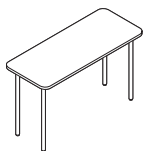

Rectangular Table, 20" Deep

MODEL#	DIMENSIONS	FREIGHT CLASS	WT/LBS.	CUBIC FT.	LIST PRICE	HP ADD	ERGO EDGE
ZKR3020L	20 x 30 x 29	70	50	2.55	\$339	\$79	\$26
ZKR3620L	20 x 36 x 29	70	51	2.65	\$350	\$94	\$28
ZKR4820L	20 x 48 x 29	70	58	2.95	\$387	\$124	\$33
ZKR5420L	20 x 54 x 29	70	64	3.15	\$450	\$140	\$36
ZKR6020L	20 x 60 x 29	70	70	3.25	\$467	\$155	\$39
ZKR7220L	20 x 72 x 29	65	85	3.55	\$511	\$187	\$44

Table with four round tube 18 gauge steel legs. Legs are 1.5" in diameter x 28" high with adjustable levelers. Top features 2.5" radius rounded corners and includes factory installed metal inserts for solid and secure leg connections. Shipped easy to assemble in 5 cartons, top separate from legs; legs individually packed.

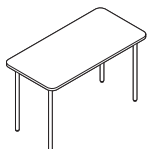

Rectangular Table, 24" Deep

ZKR3024L	24 x 30 x 29	70	51	2.75	\$342	\$94	\$27
ZKR3624L	24 x 36 x 29	70	53	2.85	\$368	\$114	\$29
ZKR4824L	24 x 48 x 29	70	59	3.25	\$411	\$149	\$34
ZKR5424L	24 x 54 x 29	70	65	3.35	\$476	\$167	\$37
ZKR6024L	24 x 60 x 29	70	71	3.55	\$497	\$186	\$40
ZKR7224L	24 x 72 x 29	70	86	3.95	\$545	\$223	\$45

Table with four round tube 18 gauge steel legs. Legs are 1.5" in diameter x 28" high with adjustable levelers. Top features 2.5" radius rounded corners and includes factory installed metal inserts for solid and secure leg connections. Shipped easy to assemble in 5 cartons, top separate from legs; legs individually packed.

Required specifications

Top finish
Edge finish
Leg finish

Optional specifications

HP laminate
Ergo friendly edge and finish

MOBILE RECTANGULAR TABLES - 29" HIGH

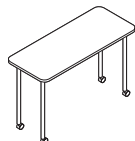

Mobile Rectangular Table, 20" Deep

MODEL #	DIMENSIONS D x W x H	FREIGHT CLASS	WT/LB.	CUBIC FT.	LIST PRICE	HP ADD	ERGO EDGE
ZKR3020C	20 x 30 x 29	70	50	2.55	\$367	\$79	\$26
ZKR3620C	20 x 36 x 29	70	51	2.65	\$377	\$94	\$28
ZKR4820C	20 x 48 x 29	70	58	2.95	\$414	\$124	\$33
ZKR5420C	20 x 54 x 29	70	64	3.15	\$477	\$140	\$36
ZKR6020C	20 x 60 x 29	70	70	3.25	\$495	\$155	\$39
ZKR7220C	20 x 72 x 29	65	85	3.55	\$539	\$187	\$44

Table with four round tube 18 gauge steel legs. Legs are 1.5" in diameter x 28" high with 1.5" dual wheel locking casters. Top features 2.5" radius rounded corners and includes factory installed metal inserts for solid and secure leg connections. Shipped easy to assemble in 5 cartons, top separate from legs; legs individually packed.

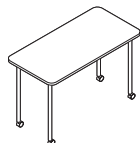

Mobile Rectangular Table, 24" Deep

ZKR3024C	24 x 30 x 29	70	51	2.75	\$370	\$94	\$27
ZKR3624C	24 x 36 x 29	70	53	2.85	\$396	\$114	\$29
ZKR4824C	24 x 48 x 29	70	59	3.25	\$439	\$149	\$34
ZKR5424C	24 x 54 x 29	70	65	3.35	\$504	\$167	\$37
ZKR6024C	24 x 60 x 29	70	71	3.55	\$525	\$186	\$40
ZKR7224C	24 x 72 x 29	70	86	3.95	\$573	\$223	\$45

Table with four round tube 18 gauge steel legs. Legs are 1.5" in diameter x 28" high with 1.5" dual wheel locking casters. Top features 2.5" radius rounded corners and includes factory installed metal inserts for solid and secure leg connections. Shipped easy to assemble in 5 cartons, top separate from legs; legs individually packed.

Required specifications

Top finish
Edge finish
Leg finish

Optional specifications

HP laminate
Ergo friendly edge and finish

ACTIVITY TABLES

Sample activity table configurations

D x W x H

Straight mating edges

ZK54RECTL x 2

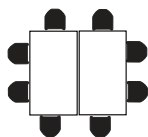

ZK54RNDSL x 2

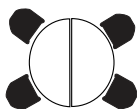

ZK54HEXSL x 2

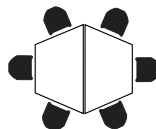

Curved mating edges

ZK54WAVCL x 2

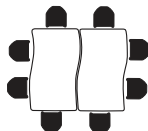

ZK54RDNDCL x 2



ZK54HEXCL x 2

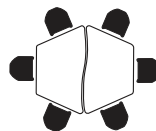

Mixed shapes
Curved mating edges shown.
Can also do the same with
straight mating edge tables.

ZK54RDNDCL x 2
ZK54WAVCL x 1

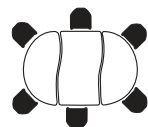

ZK54RDNDCL x 2
ZK54WAVCL x 2

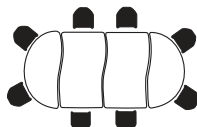

ZK54HEXCL x 2
ZK54WAVCL x 1

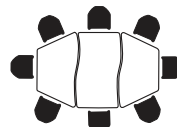

ACTIVITY TABLES - 29" HIGH, CURVED

MODEL# DIMENSIONS FREIGHT CLASS WT/LBS. CUBIC FT. LIST PRICE HP ADD ERGO EDGE

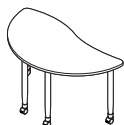

Curved Half Round w/Casters

ZK54RDNDCC 28.4 x 54 x 29 65 67.4 1.40 \$685 \$155 \$42

44.3" inside clearance between legs on curved edge, 22.9" on narrow depth side and 24" on other side. Dual leg position on front interferes with users sitting on ends in a racetrack configuration, oriented to seat two - one on either side. Top includes factory installed inserts for metal-to-metal leg connection. Shipped easy to assemble in 2 cartons, top separate from leg.

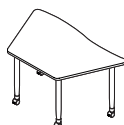

Curved Half Hex w/Casters

ZK54HEXCC 32.4 x 54 x 29 65 76.4 1.49 \$739 \$179 \$51

42.9" inside clearance between legs on curved edge, 22.3" on narrow depth side and 24" on other side. 22.8" on straight end. Top includes factory installed inserts for metal-to-metal leg connection. Shipped easy to assemble in 2 cartons, top separate from leg.

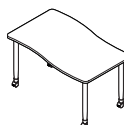

Wave w/Casters

ZK54WAVCC 33.8 x 54 x 29 65 77.4 1.52 \$762 \$190 \$60

44.9" inside clearance between legs on curved edge, 21.9" on sides. Top includes factory installed inserts for metal-to-metal leg connection. Shipped easy to assemble in 2 cartons, top separate from leg.

Required specifications

Top finish
Edge finish
Leg finish

Optional specifications

HP laminate
Ergo friendly edge and finish

ACTIVITY TABLES - 29" HIGH, CURVED

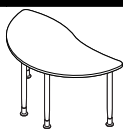

Curved Half Round w/Levelers*

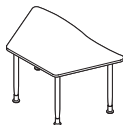

Curved Half Hex w/Levelers*

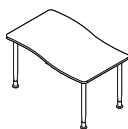

Wave w/Levelers*

MODEL #	DIMENSIONS	FREIGHT CLASS	WT/LB.	CUBIC FT.	LIST PRICE	HP ADD	ERGO EDGE
---------	------------	---------------	--------	-----------	------------	--------	-----------

	D x W x H						
ZK54RNDCL	28.4 x 54 x 29	65	67.4	1.40	\$679	\$155	\$42

44.3" inside clearance between legs on curved edge, 22.9" on narrow depth side and 24" on other side. Dual leg position on front interferes with users sitting on ends in a racetrack configuration, oriented to seat two - one on either side. Top includes factory installed inserts for metal-to-metal leg connection. Shipped easy to assemble in 2 cartons, top separate from leg.

ZK54HEXCL	32.4 x 54 x 29	65	76.4	1.49	\$733	\$179	\$51
-----------	----------------	----	------	------	-------	-------	------

42.9" inside clearance between legs on curved edge, 22.3" on narrow depth side and 24" on other side. 22.8" on straight end. Top includes factory installed inserts for metal-to-metal leg connection. Shipped easy to assemble in 2 cartons, top separate from leg.

ZK54WAVCL	33.8 x 54 x 29	65	77.4	1.52	\$756	\$190	\$60
-----------	----------------	----	------	------	-------	-------	------

44.9" inside clearance between legs on curved edge, 21.9" on sides. Top includes factory installed inserts for metal-to-metal leg connection. Shipped easy to assemble in 2 cartons, top separate from leg.

ACTIVITY TABLES - 29" HIGH, STRAIGHT

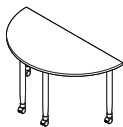

Straight Half Round w/Casters

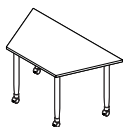

Straight Half Hex w/Casters



Rectangular w/Casters

MODEL#	DIMENSIONS	FREIGHT CLASS	WT/LBS.	CUBIC FT.	LIST PRICE	HP ADD	ERGO EDGE
--------	------------	---------------	---------	-----------	------------	--------	-----------

ZK54RNDSC	28.4 x 54 x 29	65	67.4	1.40	\$647	\$138	N/A
-----------	----------------	----	------	------	-------	-------	-----

44.2" inside clearance between legs on long side, 23.7" on the sides. Dual leg position on front interferes with users sitting on ends in a racetrack configuration, oriented to seat two - one on either side. Top includes factory installed inserts for metal-to-metal leg connection. Shipped easy to assemble in 2 cartons, top separate from leg.

ZK54HEXSC	32.4 x 54 x 29	65	73.4	1.49	\$669	\$147	N/A
-----------	----------------	----	------	------	-------	-------	-----

40.6" inside clearance between legs on long side, 21.4" on sides and 22.3" on short side. Top includes factory installed inserts for metal-to-metal leg connection. Shipped easy to assemble in 2 cartons, top separate from leg.

ZK54RECTC	33.8 x 54 x 29	65	73.4	1.52	\$706	\$165	N/A
-----------	----------------	----	------	------	-------	-------	-----

45.3" inside clearance between legs on long sides and 22.3" on short sides. Top includes factory installed inserts for metal-to-metal leg connection. Shipped easy to assemble in 2 cartons, top separate from leg.

Required specifications

Top finish
Edge finish
Leg finish

Optional specifications

HP laminate
Ergo friendly edge and finish* (not available on tables with straight mating edge)

ACTIVITY TABLES - 29" HIGH, STRAIGHT



Straight Half Round w/Levelers

MODEL #	DIMENSIONS D x W x H	FREIGHT CLASS	WT/LBS.	CUBIC FT.	LIST PRICE	HP ADD	ERGO EDGE
ZK54RNDSL	28.4 x 54 x 29	65	67.4	1.40	\$641	\$138	N/A

44.2" inside clearance between legs on long side, 23.7" on the sides. Dual leg position on front interferes with users sitting on ends in a racetrack configuration, oriented to seat two - one on either side. Top includes factory installed inserts for metal-to-metal leg connection. Shipped easy to assemble in 2 cartons, top separate from leg.

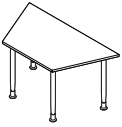

Straight Half Hex w/Levelers

ZK54HEXSL	32.4 x 54 x 29	65	73.4	1.49	\$663	\$147	N/A
-----------	----------------	----	------	------	--------------	--------------	-----

40.6" inside clearance between legs on long side, 21.4" on sides and 22.3" on short side. Top includes factory installed inserts for metal-to-metal leg connection. Shipped easy to assemble in 2 cartons, top separate from leg.

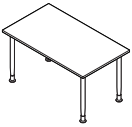

Rectangular w/Levelers

ZK54RECTL	33.8 x 54 x 29	65	73.4	1.52	\$700	\$165	N/A
-----------	----------------	----	------	------	--------------	--------------	-----

45.3" inside clearance between legs on long sides and 22.3" on short sides. Top includes factory installed inserts for metal-to-metal leg connection. Shipped easy to assemble in 2 cartons, top separate from leg.

Required Specifications

Top finish
Edge finish
Leg finish

Optional Specifications

HP laminate

FLIP-TOP TABLES

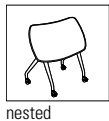

nested

Flip-Top Table, Contoured Top

MODEL#	DIMENSIONS D x W x H	FREIGHT CLASS	WT/LBS.	CUBIC FT.	LIST PRICE	HP ADD	ERGO EDGE
ZKFC3022	22 x 30 x 29.5	92.5	53.5	4.07	\$682	\$91	\$72

Mobile flip-top table with smooth glide locking casters. Easy to operate twist knob with integrated thumb tab. Top includes factory installed inserts for metal-to-metal leg connection. When nested, each additional table adds 5.25" to footprint needed for storage. Optional modesty (ZKFTM30) available separately. Shipped easy to assemble in 2 cartons, top and base shipped separately. Legs available in Tungsten (TUN) only.

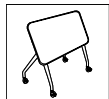

nested

Flip-Top Table, Rectangular Top

ZKFR3024	24 x 30 x 29.5	92.5	48	4.07	\$703	\$100	\$84
----------	----------------	------	----	------	--------------	--------------	-------------

Mobile flip-top table with smooth glide locking casters. Easy to operate twist knob with integrated thumb tab. Top includes factory installed inserts for metal-to-metal leg connection. When nested, each additional table adds 5.25" to footprint needed for storage. Optional modesty (ZKFTM30) available separately. Shipped easy to assemble in 2 cartons, top and base shipped separately. Legs available in Tungsten (TUN) only.

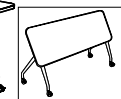

nested

Flip-Top Table, Rectangular Top*

ZKFR6024	24 x 60 x 29.5	92.5	73.9	5.28	\$866	\$150	\$86
----------	----------------	------	------	------	--------------	--------------	-------------

Mobile flip-top table with smooth glide locking casters. Easy to operate twist knob with integrated thumb tab. Top includes factory installed inserts for metal-to-metal leg connection. When nested, each additional table adds 5.25" to footprint needed for storage. Optional modesty (ZKFTM60) available separately. Shipped easy to assemble in 3 cartons, top and base shipped separately. Legs available in Tungsten (TUN) only.



Modesty for ZKFC3022 and ZKFC3024

ZKFTM30	0.5 x 17.8 x 13.8	60	6.6	0.22	\$47	n/a	n/a
---------	-------------------	----	-----	------	-------------	-----	-----

Hardware included to attach to ZKFC3022 or ZKFR3024. Tungsten finish only. Shipped in 1 carton.

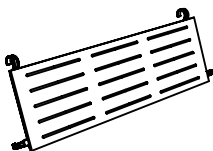

Modesty for ZKFR6024

ZKFTM60	0.5 x 47.3 x 13.8	65	14.3	0.57	\$93	n/a	n/a
---------	-------------------	----	------	------	-------------	-----	-----

Hardware included to attach ZKFC3022. Tungsten finish only. Shipped in 1 carton.

Required Specifications

Top finish
Edge finish

Optional Specifications

HP laminate
Ergo friendly edge and finish
Grommet*

C CITI TABLES

CITI TABLES	MODEL#	DIMENSIONS D x W x H	FREIGHT CLASS	WT/LBS.	CUBIC FT.	LIST PRICE
-------------	--------	-------------------------	---------------	---------	-----------	------------

- Notes**
- Citi tables complement the contemporary timeless decor of many offices.
 - Legs are **standard** in Tungsten (**TUN**) and also available in Black (**BK**) finish at no charge. A Chrome (**CHM**) finish is available. **Add \$80.**
 - Table tops are available in either tempered glass or laminate
 - Citi tables are offered in the following finishes to coordinate with Global casegoods and wood seating:

ACJ	Absolute Acajou	HGT	Hayden Grey
ASN	Asian Night	QTM	Quartered Mahogany
AWC	Avant Cherry	SOG	Storm Grey
AWH	Avant Honey	TFW	Tiger Fruitwood
BLK	Black	TWL	Tiger Walnut
BRC	Brushed Cobalt	WHE	Walnut Heights
CMB	Clear Maple	WHC	White Chocolate
DES	Dark Espresso	WCR	Winter Cherry
DWT	Designer White	WGY	Willow Grey

CITI TABLES	MODEL#	DIMENSIONS	FREIGHT CLASS	WT/LBS.	CUBIC FT.	LIST PRICE
-------------	--------	------------	---------------	---------	-----------	------------

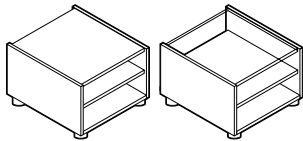

End Table

7885 (laminate top)	20 x 24 x 20	100	53	6	\$580
7886 (glass top)	20 x 24 x 20	92.5	60	6	\$819

Metal tubular legs. Laminate or tempered glass tops available.

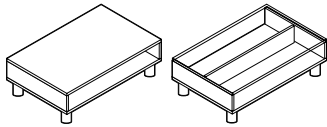

Coffee Table - Rectangular

7887 (laminate top)	20 x 40 x 15	100	60	6.50	\$605
7888 (glass top)	20 x 40 x 15	92.5	75	6.50	\$942

Metal tubular legs. Laminate or tempered glass tops available.

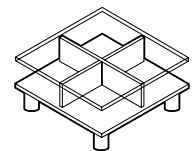

Coffee Table - Square

7889 (glass top)	33 x 33 x 15	92.5	90	8.75	\$1144
---------------------	--------------	------	----	------	---------------

Metal tubular legs. Tempered glass top.

Required Specifications
Finish

COAT TREES

MODEL# DIMENSIONS FREIGHT CLASS WT/LBS. CUBIC FT. LIST PRICE



Coat Tree

	D x W x H				
PCOS2	25 x 25 x 60	300	8	4.67	\$366
PCOS3	25 x 25 x 60	300	8	4.67	\$366

Square tube metal frame, complete with four Chrome double hooks. Adjustable glides. 60" high. Ships UPS.

- 3 per carton
- PCOS2 is finished in **Black**.
- PCOS3 is finished in **Chrome**.



Coat Tree

PCT	25 x 25 x 65	250	6	3	\$469
-----	--------------	-----	---	---	--------------

Square tube. Complete with four satin brass double hooks. 65" high. Available in the following finishes: Absolute (AAM), Cherry (ACM), Honey (AHM), Maple (AVM), Black (BKM), English Oak (EOM), Gray (HGM), Medium Walnut (MWM), Night (ASM), Sandy Beach (SBM), Mahogany (TMM), Fruitwood (TFM), White (WHM), Winter Cherry (WCM) and Walnut (TWM). Ships UPS.

- 1 per carton

Required Specifications

Finish

D DAWSON TABLES

DAWSON TABLES	MODEL#	DIMENSIONS	FREIGHT CLASS	WT/LBS.	CUBIC FT.	LIST PRICE
D x W x H						

- Notes**
- Dawson tables feature elegant lines and details and were specifically created to offer a design-sensitive look that coordinates with the wood finishes and details of Global's lounge seating and casegoods.
 - Tapered hardwood legs and edges
 - Tops feature a sophisticated edge detail with frosted tempered safety glass or hardwood veneer inserts.
 - Offered in the following finishes to coordinate with Global casegoods and wood seating:

ACM	Cherry	BKM	Black	HOM	Harvest Oak on Maple	AVM	Maple
TMM	Mahogany	AHM	Honey	TFM	Fruitwood	TWM	Walnut
EOM	English Oak	ECM	Espresso Café				
 - Glass tops are 8 mm thick
 - Tempered glass is lightly frosted on the bottom side of the top to create a slightly translucent look. The top side of the glass is not frosted to insure ease of cleaning.
 - Shipped fully assembled.

DAWSON TABLES	MODEL#	DIMENSIONS	FREIGHT CLASS	WT/LBS.	CUBIC FT.	LIST PRICE
---------------	--------	------------	---------------	---------	-----------	------------

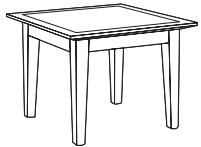

Square End Table

3374-G (glass top)	22 x 22 x 17	150	27	6.75	\$1098
-----------------------	--------------	-----	----	------	---------------

3374-W (veneer top)	22 x 22 x 17	150	30	6.75	\$1046
------------------------	--------------	-----	----	------	---------------

Tapered hardwood edge with tapered legs.

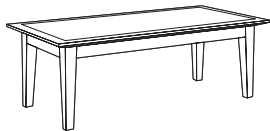

Rectangular Coffee Table

3376-G (glass top)	42 x 21 x 15	150	45	11	\$1598
-----------------------	--------------	-----	----	----	---------------

Tapered hardwood edge with tapered legs.

Required Specifications
Finish

LAMINATE OCCASIONAL TABLES	MODEL#	DIMENSIONS	FREIGHT CLASS	WT/LBS.	CUBIC FT.	LIST PRICE
----------------------------	--------	------------	---------------	---------	-----------	------------

D x W x H

Notes:

- Ideal for reception areas - colors coordinate with all Global desks, conference tables and accessories.
- Available to either match or coordinate with most Global laminate desk series. Available finishes.
- High pressure laminate exterior
- Premium cylinder tables have a flexible plywood core construction ideal for institutional and high traffic environments
- Adjustable glides are standard
- Ships one per carton.

ACJ	Absolute Acajou	HGT	Hayden Grey
ASN	Asian Night	QTM	Quartered Mahogany
AWC	Avant Cherry	SOG	Storm Grey
AWH	Avant Honey	TFW	Tiger Fruitwood
BLK	Black	TWL	Tiger Walnut
BRC	Brushed Cobalt	WHE	Walnut Heights
CMB	Clear Maple	WHC	White Chocolate
DES	Dark Espresso	WCR	Winter Cherry
DWT	Designer White	WGY	Willow Grey

LAMINATE OCCASIONAL TABLES	MODEL#	DIMENSIONS	FREIGHT CLASS	WT/LBS.	CUBIC FT.	LIST PRICE
----------------------------	--------	------------	---------------	---------	-----------	------------

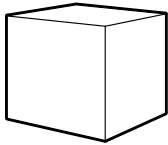

Cube Table

GCU1816	18 x 18 x 16	85	40	3.30	\$449
GCU1821	18 x 18 x 21	92.5	46	4	\$524
GCU2416	24 x 24 x 16	92.5	63	6	\$524
GCU2421	24 x 24 x 21	92.5	83	7	\$524

3/4" plywood covered in high pressure laminate. Plastic glides. **Flush base.**

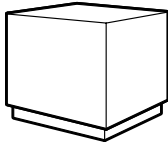

Plinth Cube Table

GCUP1816	18 x 18 x 16	85	40	3	\$496
GCUP1821	18 x 18 x 21	92.5	46	4	\$573
GCUP2416	24 x 24 x 16	92.5	63	6	\$573
GCUP2421	24 x 24 x 21	92.5	83	7	\$573

3/4" plywood covered in high pressure laminate. Plastic glides. **Recessed base.**

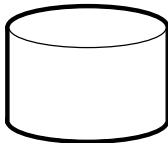

Cylinder Table

GCY1816	18 x 18 x 16	85	43	3.30	\$449
GCY1821	18 x 18 x 21	92.5	49	4.30	\$524
GCY2416	24 x 24 x 16	125	47	6	\$524
GCY2421	24 x 24 x 21	100	66	7	\$524
GCY3016	30 x 30 x 16	125	59	8	\$596
GCY3021	30 x 30 x 21	125	78	11	\$596

3/8" foundation board covered in high pressure laminate. Plastic glides. **Flush base.**

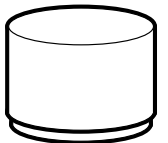

Plinth Cylinder Table

GCYP1816	18 x 18 x 16	85	43	3.30	\$496
GCYP1821	18 x 18 x 21	92.5	49	4.30	\$573
GCYP2416	24 x 24 x 16	125	47	6	\$573
GCYP2421	24 x 24 x 21	100	66	7	\$573
GCYP3016	30 x 30 x 16	125	59	8	\$652
GCYP3021	30 x 30 x 21	125	78	11	\$652

3/8" foundation board covered in high pressure laminate. Plastic glides. **Recessed base.**

Required Specifications

Finish

L LAMINATE OCCASIONAL TABLES / LITE LIFT II

LAMINATE OCCASIONAL TABLES

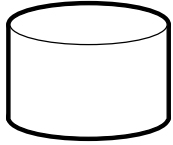

Premium Cylinder Table

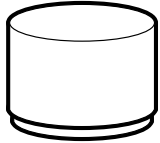

Premium Plinth Cylinder Table

MODEL#	DIMENSIONS D x W x H	FREIGHT CLASS	WT/LBS.	CUBIC FT.	LIST PRICE
CPFD1816	18 x 18 x 16	150	30	7	\$749
CPFD1821	18 x 18 x 21	150	30	7	\$770
CPFD2416	24 x 24 x 16	250	42	11.50	\$778
CPFD2421	24 x 24 x 21	250	42	11.50	\$798
CPFD3016	30 x 30 x 16	250	52	17	\$880
CPFD3021	30 x 30 x 21	250	52	17	\$970

¾" plywood covered in high pressure laminate. Plastic glides. **Flush base.**

CPPD1816	18 x 18 x 16	150	30	7	\$788
CPPD1821	18 x 18 x 21	150	30	7	\$809
CPPD2416	24 x 24 x 16	250	42	11.50	\$817
CPPD2421	24 x 24 x 21	250	42	11.50	\$837
CPPD3016	30 x 30 x 16	250	52	17	\$934
CPPD3021	30 x 30 x 21	250	52	17	\$1024

¾" plywood covered in high pressure laminate. Plastic glides. **Recessed base.**

LITE LIFT II

Notes:

- Lightweight construction allows tables to easily and safely be lifted and moved by one person.
- Polypropylene top is fully water resistant and easy to clean and maintain.
- Thick, high impact radius corner helps protect individuals from injury.
- Folding legs automatically lock by a gravity activated mechanism when opened.
- Non-marring plastic glides protect floors from scratching when tables are moved.
- Structural side aprons allow tables to easily stack.
- Lite Lift II tables pass all BIFMA standards for strength and stability.
- **Available in Oyster Grey finish only.**

LITE LIFT II TABLES



MVLFRT48

MVLFRT60-MVLFRT96

Rectangular Folding Table

MODEL#	DIMENSIONS	FREIGHT CLASS	WT/LBS.	CUBIC FT.	LIST PRICE
MVLFRT48	24 x 48 x 29.25	85	23	1.57	\$214
MVLFRT60	30 x 60 x 29.25	92.5	30	2.54	\$261
MVLFRT72	30 x 72 x 29.25	92.5	36	3.06	\$284
MVLFRT96	30 x 96 x 29.25	92.5	50	4.79	\$386

Lightweight, textured, polypropylene Oyster Grey finish top. High impact radius corners. 19 gauge 11/8" diameter steel tubular legs with welded crossbars automatically lock. Legs finished in scuff resistant textured Charcoal Grey epoxy paint. Shipped fully assembled.

- Available in Oyster Grey finish with Charcoal Grey legs only.
- **Note:** Prices shown are for Global Distribution Center, not delivered pricing. All orders will be charged freight, except orders containing other Global products totalling \$2,000 list or more, before adding folding tables and folding chairs. Any Inside Delivery & Set-up charge for these products must be quoted separately.

Required Specifications

Finish

SIRENA TABLES	MODEL#	DIMENSIONS	FREIGHT CLASS	WT/LBS.	CUBIC FT.	LIST PRICE
---------------	--------	------------	---------------	---------	-----------	------------

D x W x H

- Modern tables for reception areas, meeting rooms, and private office use.
- Sirena tables are offered in the following finishes to coordinate with Global desking and wood seating:

ACJ	Absolute Acajou	HGT	Hayden Gray
ASN	Asian Night		
AWC	Avant Cherry		
AWH	Avant Honey	TWL	Tiger Walnut
CMB	Clear Maple	WHE	Walnut Heights
DES	Dark Espresso	WHC	White Chocolate
DWT	Designer White	WCR	Winter Cherry

- MDF tops are 3/4" thick and feature a refined edge with a round triangular profile and an epoxy finish. Offered in MDF table tops, tablets and book shelves are also offered in Charcoal (**CHR**). Please specify.
- Laminate tops are 1 1/2" thick to coordinate with Global desking and wood seating
- Table legs are available in Tungsten (**TUN**), Charcoal (**CHR**), Black (**BLK**) at no upcharge. Not available in Chrome.
- Legs are 1 1/2" steel tubing, tapered toward the bottom of the leg to 7/8", equipped with self-leveling pivoting steel glide.

SIRENA TABLES	MODEL#	DIMENSIONS	FREIGHT CLASS	WT/LBS.	CUBIC FT.	LIST PRICE
---------------	--------	------------	---------------	---------	-----------	------------

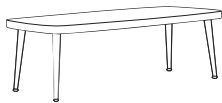

Coffee Table

3400 (laminated top)	22 x 48 x 15	250	52	17.25	\$1303
3406 (mdf top)	22 x 48 x 14.25	250	38	17.25	\$1586



Coffee Table

3401 (laminated top)	22 x 56 x 15	250	60	19.75	\$1441
3407 (mdf top)	22 x 56 x 14.25	250	44	19.75	\$1810



End Table

3402 (laminated top)	22 x 17 x 15	250	26	7.75	\$1045
3408 (mdf top)	22 x 17 x 14.25	250	20	7.75	\$1276

Required Specifications

Top Finish
Leg Finish

W WIND TABLES

WIND TABLES	MODEL#	DIMENSIONS	FREIGHT CLASS	WT/LBS.	CUBIC FT.	LIST PRICE
D x W x H						

- Notes:**
- Wind tables complement the modern decor of many offices.
 - Legs are standard in Chrome. Tungsten (**TUN**) and Charcoal (**CHR**) finishes are available at no upcharge.
 - Table tops are available in two different finishes; MDF tops feature a refined edge with a rounded triangular profile and Epoxy finish. Available in Charcoal (**CHR**) or White (**WHT**). Please Specify.

• Laminate tops are offered in the following finishes to coordinate with Global casegoods and wood seating:

ACJ	Absolute Acajou	HGT	Hayden Grey
ASN	Asian Night	QTM	Quartered Mahogany
AWC	Avant Cherry	SOG	Storm Grey
AWH	Avant Honey	TFW	Tiger Fruitwood
BLK	Black	TWL	Tiger Walnut
BRC	Brushed Cobalt	WHE	Walnut Heights
CMB	Clear Maple	WHC	White Chocolate
DES	Dark Espresso	WCR	Winter Cherry
DWT	Designer White	WGY	Willow Grey

• Table tops are available in high pressure laminate at a 20% upcharge.

WIND TABLES	MODEL#	DIMENSIONS	FREIGHT CLASS	WT/LBS.	CUBIC FT.	LIST PRICE
-------------	--------	------------	---------------	---------	-----------	------------



Square Corner Table

3356	(MDF top)	24 x 24 x 17	250	30	11.50	\$831
------	-----------	--------------	-----	----	-------	--------------

3366	(laminat top)	24 x 24 x 17	250	36	11.50	\$654
------	---------------	--------------	-----	----	-------	--------------

Steel tubular base in Chrome finish. Tops are available with an mdf or laminate finish. MDF tops feature a refined edge with a rounded triangular profile and an epoxy finish.



Rectangular Coffee Table

3357	(MDF top)	20 x 48 x 15	250	43	16	\$1080
------	-----------	--------------	-----	----	----	---------------

3367	(laminat top)	20 x 48 x 15	250	52	16	\$865
------	---------------	--------------	-----	----	----	--------------

Steel tubular base in Chrome finish. Tops are available with an mdf or laminate finish. MDF tops feature a refined edge with a rounded triangular profile and an epoxy finish.



Square Coffee Table

3358	(MDF top)	36 x 36 x 15	250	54	22	\$1369
------	-----------	--------------	-----	----	----	---------------

3368	(laminat top)	36 x 36 x 15	250	66	22	\$1172
------	---------------	--------------	-----	----	----	---------------

Steel tubular base in Chrome finish. Tops are available with an mdf or laminate finish. MDF tops feature a refined edge with a rounded triangular profile and an epoxy finish.



Round Corner Table

3860	(MDF top)	24 x 24 x 17	250	30	11.50	\$1032
------	-----------	--------------	-----	----	-------	---------------

3870	(laminat top)	24 x 24 x 17	250	35	11.50	\$716
------	---------------	--------------	-----	----	-------	--------------

Steel tubular base in Chrome finish. Tops are available with an mdf or laminate finish. MDF tops feature a refined edge with a rounded triangular profile and an epoxy finish.

Required Specifications
Finish

Optional Specifications
Leg finish

WIND TABLES



Round Coffee Table

MODEL#	DIMENSIONS	FREIGHT CLASS	WT/LBS.	CUBIC FT.	LIST PRICE
--------	------------	---------------	---------	-----------	------------

D x W x H

3861 (MDF top)	36 x 36 x 15	250	52	22	\$1505
3871 (lamine top)	36 x 36 x 15	250	57	22	\$1054

Steel tubular base in Chrome finish. Tops are available with an mdf or laminate finish. MDF tops feature a refined edge with a rounded triangular profile and an epoxy finish.

WIND LINEAR TABLES

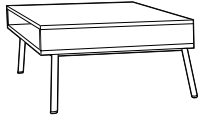

Freestanding Rectangular End Table

MODEL#	DIMENSIONS	FREIGHT CLASS	WT/LBS.	CUBIC FT.	LIST PRICE
--------	------------	---------------	---------	-----------	------------

3878	25 x 20 x 16	250	38	11.50	\$937
------	--------------	-----	----	-------	--------------

Steel tubular base in Chrome finish. Laminate top is 5" thick with opening on front for storage and visual recess at rear. Shipped assembled in 1 carton.

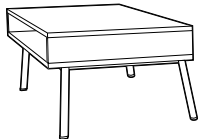

Freestanding Corner Table

3879	25 x 25 x 16	250	40	11.50	\$1021
------	--------------	-----	----	-------	---------------

Steel tubular base in Chrome finish. Laminate top is 5" thick with opening on front for storage and visual recess at rear. Shipped assembled in 1 carton.

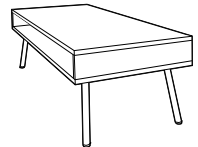

Freestanding Coffee Table

3880	54 x 20 x 15	250	52	16	\$1140
------	--------------	-----	----	----	---------------

Steel tubular base in Chrome finish. Laminate top is 5" thick with opening on front for storage and visual recess at rear. Shipped assembled in 1 carton.

Required Specifications

Finish

Optional Specifications

Leg finish

WORK TABLES

RECTANGULAR WORK TABLES	MODEL#	DIMENSIONS	FREIGHT CLASS	WT/LBS.	CUBIC FT.	LIST PRICE
D x W x H						

Notes:

• Laminate tops are offered in the following finishes to coordinate with Global casegoods and wood seating:

ACJ	Absolute Acajou	HGT	Hayden Grey
ASN	Asian Night	QTM	Quartered Mahogany
AWC	Avant Cherry	SOG	Storm Grey
AWH	Avant Honey	TFW	Tiger Fruitwood
BLK	Black	TWL	Tiger Walnut
BRC	Brushed Cobalt	WHE	Walnut Heights
CMB	Clear Maple	WHC	White Chocolate
DES	Dark Espresso	WCR	Winter Cherry
DWT	Designer White	WGY	Willow Grey

• Legs available in Chrome or Black

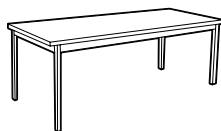

Rectangular Table

GATMS6030	30 x 60 x 29	70	132	8	\$503
GATMS7230	30 x 72 x 29	92.5	87	8	\$574
GATMS7236	36 x 72 x 29	70	132	8	\$708

1" high performance thermally fused thick plastic laminate top with self edge and Black metal skirt. Chrome or Black legs with adjustable glides. Shipped RTA (ready to assemble).

Required Specifications
Finish

Optional Specifications
Leg finish

textiles and finishes

Care and Cleaning

Textiles

Fabrics: To extend the life of your seating upholstered in fabric, regularly dust the chair to prevent airborne particles from penetrating the fabric surface.

For light soiling, use a damp cloth and blot the spot with very slight pressure, taking care never to soak the fabric. Dry with a clean cloth by blotting - never rub fabric. More intense stains can be treated the same way, but with a mild detergent. Always test fabric first in an unseen area before using any cleaning method.

Leather: For regular cleaning, simply use a soft damp cloth, taking care not to soak the leather. For more thorough treatment, soak a soft cloth in mild soap solution and wipe surface in a light circular motion. Repeat with clean water. Allow to dry and polish with a soft dry cloth. Do not use detergents, aerosol sprays or other polishes.

Hard Surfaces

Wood Veneer Finishes: Waxing or polishing catalyzed finishes is not recommended because this will give a greasy, cloudy or uneven appearance to the product and could void your warranty. Global's conversion varnish is best cleaned by wiping the surface with a damp cloth, followed by a soft dry cloth in the direction of the grain. If the surfaces are heavily soiled, a gentle product like "Windex" can be used, following the same instructions as above.

Laminate & Painted Metal Finishes: Simply wipe the surface with a clean soft damp cloth; if needed, a mild soap solution (i.e. Ivory dishwashing liquid) may be used. To prevent streaks, dry the surface with a clean dry soft cloth moving in a circular motion.

Textiles

- **Water-Based Cleaner:** Spot clean, using the foam only from a water-based cleaning agent, such as a mild detergent or non-solvent upholstery shampoo product. Apply foam with a soft brush in a circular motion. Vacuum when dry. Pretest small area before proceeding.
- **Solvent Cleaner:** Spot clean, using a mild water-free solvent or dry cleaning product. Clean only in a well-ventilated room and avoid any product containing carbon tetrachloride or other toxic materials. Pretest a small area before proceeding.
- **Water/Solvent Cleaner:** Spot clean with a mild solvent, an upholstery shampoo, or the foam from a mild detergent. When using a solvent or dry cleaning product, follow instructions carefully and clean only in a well-ventilated room. Avoid any product that contains carbon tetrachloride or other toxic materials. With either method, pretest a small area before proceeding.
- **Vacuum Only:** Clean this fabric only by vacuuming or light brushing to prevent accumulation of dust and grime. Water-based foam cleaning agents of any kind may cause excessive shrinking, staining, or distortion of the surface pile and therefore, should not be used.
- **Crypton Cleaning:** Generally stains are removed with plain water and powdered enzyme detergent. Upholstery foam shampoo, waterbased cleaning products and germicidal detergents can be used. Be sure to remove all residue from cleaning products with clean water. Do not use solvent-based cleaners or dry cleaning products.
- These recommendations and codes were developed by fabric specialists. However, because of the various ways fabric can be stained or damaged, there is no guarantee that the results will be completely successful. Use suggested methods on your own responsibility. To help prevent overall soil, frequent vacuuming or light brushing to remove dust and grime is recommended. Use professional furniture cleaning service when overall soiled condition has been reached.

TEXTILES + FINISHES

Textile Price Grades - Global Textiles

Grade 1	Bantam, Carrera, Fusion, Hudson, Illusion, Jenny, Mock Leather, Quilt, Terrace, Urban, Waterfall, Wavelength
Grade 2	Allante, Couture, Crescent, Imprint, Match, Renewal, Replay, Silhouette
Grade 3	Pure, Vital
Grade 4	Non standard GLOBAL textiles
Grade 5	Leather/Mock Leather combination
Grade 6	Non standard GLOBAL textiles
Grade 7	Non standard GLOBAL textiles
Grade 8	Genuine Leather, Non standard GLOBAL textiles
Grade 9	Non standard GLOBAL textiles
Grade 11	Non standard GLOBAL textiles
Grade 10	Non standard GLOBAL textiles
Grade 12	Non standard GLOBAL textiles

Please refer to individual seating series for availability of a particular textile.

The charts above do not include Textiles offered by Alliance Partners: Arc-Com Fabrics, CF Stinson, Designtex, Knoll Textiles, Green Hides, LDI, Luum Textiles, Maharam, Mayer Fabrics, Momentum, and Ultrafabrics.

Blended Seating Textiles

The grid below outlines the grade structure for using multiple textiles on select seating series. Blended textiles occur when one textile is chosen for one part of the chair and a different textile is selected for another part of the chair, resulting in a revised blended grade. For opportunities regarding more than two different textiles, please contact Global CustomerCare for approval process and grading.

FIRST TEXTILE SELECTED

		1	2	3	4	5	6	7	8	9	10	11	12	13	14	15	16	17	18	
SECOND TEXTILE SELECTED	1	1																		
	2	2	2																	
	3	3	3	3																
	4	3	4	4	4															
	5	4	4	5	5	5														
	6	5	5	5	6	6	6													
	7	5	6	6	6	7	7	7												
	8	6	6	7	7	7	8	8	8											
	9	7	7	7	8	8	8	9	9	9										
	10	8	8	8	8	9	9	9	10	10	10									
	11	9	9	9	9	9	10	10	10	11	11	11								
	12	10	10	10	10	10	10	11	11	11	12	12	12							
	13	11	11	11	11	11	11	12	12	12	12	13	13	13						
	14	11	12	12	12	12	12	12	13	13	13	13	14	14	14					
	15	12	12	13	13	13	13	13	13	14	14	14	14	15	15	15				
	16	13	13	13	14	14	14	14	14	14	15	15	15	15	16	16	16			
	17	14	14	14	14	15	15	15	15	15	15	16	16	16	16	17	17	17		
	18	15	15	15	15	15	16	16	16	16	16	16	17	17	17	17	18	18	18	

TEXTILE AND COLOR LISTINGS

GRADE 1

Carrera 100% Polyester

CE84 Zest	CE85 Savannah	CE86 Slate	CE87 Rainforest	CE88 Aspen	CE89 Dune	CE90 Flannel
CE91 Azure	CE92 Chili	CE93 Jute	CE95 Ink	CE96 Sangria	CE97 Java	CE98 Charcoal

Fusion 90% Virgin Polyester / 10% Post-Consumer Recycled Polyester

FU71 Tangerine	FU72 Fresh	FU73 Moss	FU74 Tomato	FU75 Aqua	FU76 Sandstone	FU77 Granite
FU78 Poppy	FU79 Cadet	FU80 Oasis	FU81 Graphite	FU82 Viola	FU83 Cobalt	FU84 Flax
FU85 Carbon						

Hudson 100% Post-Consumer Recycled Polyester

HD02 Cordovan	HD03 Ruby	HD04 Orange	HD05 Wheat	HD06 Meadow	HD07 Coffee	HD08 Grey
HD09 Mocha	HD10 Thyme	HD11 Carbon	HD12 Midnight	HD13 Ocean	HD14 Cerulean	

Jenny 100% Polyester

JN01 Midnite	JN02 Ebony	JN03 Slate	JN07 Vermilion	JN08 Admiral	JN11 Charcoal	JN25 Silver Lining
JN26 Oatmeal	JN27 Sunflower	JN28 Cascade	JN29 Harvest	JN30 Melon	JN31 Berry	JN32 Green Grass
JN33 Roast						

Mock Leather 100% Polyvinyl Chloride

550 Black	559 Chamois	570 Surf	571 Latte	572 Melon	573 Delta	576 Jade
574 Bronze	575 Rouge	577 Graphite	578 Chaps	579 Cabernet	591 Alpine	

Quilt 100% Polyester

QL10 Black	QL11 Charcoal Grey	QL14 Navy	QL16 Wine	QL19 Silver	QL20 Feather	QL21 Dune
QL22 Meadow	QL23 Cadet	QL24 Geranium	QL25 Daisy	QL26 Quest	QL27 Punch	QL28 Tangerine
QL29 Cocoa						

Terrace 70% Virgin Polyester / 30% Post-Consumer Recycled Polyester

TC60 Lotus	TC61 Tigerlily	TC62 Shadow	TC63 Cobble	TC64 Cherry Blossom	TC65 Bluebell	TC66 Apple
TC67 Haze	TC68 Cerise	TC69 Twilight	TC70 Wintergreen	TC71 Ironwork	TC72 Pine Cone	TC73 Flirt
TC74 Echo						

Urban 62% Recycled Polyester / 32% Polyester

UR10 Red Rose	UR11 Ocean Blue	UR12 Blue Bayou	UR13 Green Grass	UR14 Sandcastle	UR15 Beach Day	UR16 Boardwalk
UR17 Earth	UR18 Brown Ridge	UR19 White Sand	UR20 Granite Rock	UR21 Gravel Road	UR22 Black Coal	

Waterfall 60% Virgin Polyester / 40% Post-Consumer Recycled Polyester

WA40 Trance	WA41 Tryst	WA42 Splash	WA43 Victoria	WA44 Imagine	WA45 Sky	WA46 Rainforest
WA47 Rumble	WA48 Prism	WA49 Tranquility	WA50 Grand	WA51 Rushing	WA52 Magestic	WA53 Pacific
WA54 Dance						

GRADE 2

Crescent 100% Nylon with Teflon Designed to color coordinate with Renewal fabrics.

700 Cocoa	701 Pear	702 Silver	703 Oatmeal	704 Lemon	705 Flame	706 Stem
709 Ruby	789 Raven	790 Cobalt Blue	792 Cinder Grey	799 Pine	800 Arctic	

Elevate 80% Post-Consumer Recycled Polyester/ 20% Rayon

EL51 Halo	EL52 Dove	EL53 Safari	EL54 Sunglow	EL55 Margarita	EL56 Fiji	EL57 Mist
EL58 Blaze	EL59 Wasabi	EL60 Mystic	EL61 Mica	EL62 Cherry	EL63 Scuba	EL64 Lapis
EL65 Onyx						

Etch 80% Post-Consumer Recycled Polyester/ 20% Rayon

ET81 Drift	ET82 Citron	ET83 Calypso	ET84 Mandarin	ET85 Crisp	ET86 Iris	ET87 Nickel
ET88 Paprika	ET89 Nutmeg	ET90 Marine	ET91 Magnet	ET92 Infrared	ET93 Espresso	ET94 Indigo
ET95 Anthracite						

Imprint 100% Post-Consumer Polyester

IM70 Almond	IM71 Cork	IM72 Sand	IM73 Currie	IM74 Candy Apple	IM75 Ocean	IM76 Navy
IM78 Celery	IM77 Green Tea	IM79 Oregon	IM80 Walnut	IM81 Paprika	IM82 Graphite	IM83 Slate
IM84 Licorice						

TEXTILES + FINISHES

GRADE 2 (continued)

Match 100% Recycled Polyester

MT20 Desert	MT21 Sand	MT22 Moss	MT23 Orange	MT24 Sunset	MT25 Blue	MT26 Wave
MT27 Green	MT28 Chocolate	MT29 Burgundy	MT30 Grey	MT31 Quarry	MT32 Black	MT33 Arctic

Renewal 70% Nylon / 30% Recycled Polyester with Teflon Designed to color coordinate with Crescent fabrics.

RN30 Pewter	RN31 Cork	RN32 Cherry Fields	RN33 Volcanic Ash	RN34 Thunderstorm	RN36 Blue Grass	RN38 Leaf
RN39 Melon	RN40 Blueberry	RN41 Blue Bayou	RN44 Tomato	RN45 Amethyst	RN47 Ochre	

Replay 100% Post-Consumer Recycled Polyester

RP20 Taupe	RP21 Caramel	RP22 Paprika	RP23 Wine	RP24 Ocean	RP25 Navy	RP26 Pistachio
RP27 Moss	RP28 Turquoise	RP29 Teal	RP30 Autumn	RP31 Dark Chocolate	RP32 Slate	RP33 Dove
RP34 Coal						

Silhouette 100% Nylon with Teflon

SL20 Asphalt	SL21 Acorn	SL22 Indigo	SL23 Shiraz	SL24 Verdant	SL25 Bronze	SL26 Camel
SL27 Jade	SL28 Sienna	SL30 Charcoal	SL32 Claret	SL35 Hunter	SL36 Sapphire	

GRADE 2 (Vinyl) For availability of chair series in Vinyl, please contact a Global Sales Representative.

Allante Free 100% Vinyl Face / 100% Polyester Backing

A01F Illusion	A02F Bright White	A03F White Crush	A04F Ivory	A05F Ice	A06F Bleached Sand	A07F Taupe Fawn
A08F Warm Smoke	A09F Autumn Rain	A10F Cookie	A11F Sierra Brick	A12F Gibraltar	A13F Chateau Grey	A14F Garden Green
A15F Oasis Green	A16F Ink Black	A17F Purple Impulse	A18F Italian Rose	A19F Mountain Sky	A20F Old Navy	A21F Galaxy
A22F Red Truffle	A23F Chocolate Sundae	A24F Province Blue	A25F Eclipse			

GC Linen 100% Vinyl Face

LE50 Potters Clay	LE51 Pearl	LE52 Tan	LE53 Storm	LE54 Butter	LE55 Haystack	LE56 Ganache
LE57 Sunset	LE58 Burnt Orange	LE59 Cayenne	LE60 Navy	LE61 Bamboo	LE62 Gray	LE63 Charcoal
LE64 Moss						

Release 100% Vinyl Face

RL11 White	RL12 Chalk	RL13 Stone	RL14 Taupe	RL15 Orange	RL16 Country	RL17 Tucsan
RL18 Cottage	RL19 Yellow	RL21 Red Barn	RL22 Brave Red	RL23 Gypsy Red	RL24 Cajun	RL25 Vineyard
RL26 Olive	RL27 Bonsai	RL28 Summer's Dream	RL29 Calico	RL31 Green	RL32 Blue	RL33 Black
RL34 Cool Grey	RL35 Thunder Grey	RL36 Navy	RL37 Dark Chocolate	RL38 Espresso		

GRADE 2 (Recycled)

Couture 100% Post-Consumer Polyester

CE70 Champagne	CE71 Mocha	CE72 Pecan	CE73 Raspberry	CE74 Sapphire	CE75 Neptune	CE76 Lake
CE77 Willow	CE78 Sassy	CE79 Fudge	CE80 Persimmon	CE81 Carbon	CE82 Sterling	CE83 Peat

GRADE 5

Genuine Leather/Mock Leather combinations 100% Leather / 100% Polyvinyl Chloride

450/550 Black	459/559 Chamois	470/570 Surf	471/571 Latte	472/572 Melon	473/573 Delta	474/574 Bronze
475/575 Rouge	476/576 Jade	477/577 Graphite	478/578 Chaps	479/579 Cabernet	491/591 Alpine	

GRADE 8

Genuine Leather 100% Leather

450 Black	459 Chamois	470 Surf	471 Latte	472 Melon	473 Delta	474 Bronze
475 Rouge	476 Jade	477 Graphite	478 Chaps	479 Cabernet	491 Alpine	

PANEL FABRICS

GRADE 1

Agate II 100% Polypropylene

AG21 Bamboo	AG22 Linen	AG24 Slate	AG25 Grey	AG27 Mauve
-------------	------------	------------	-----------	------------

GRADE 2

Lola 100% Polyester Designed to color coordinate with Brinx and Mariposa panel fabrics.

LL11 Medium Taupe	LL12 Caramel Cream	LL13 Straw	LL14 Blue Mist	LL15 Zucchini	LL16 Natural	LL17 Cafe Au Lait
LL18 Mortar	LL19 Black					

PANEL FABRICS (continued)

GRADE 3

Anchorage 65% Pre-consumer Polyester / 35% Post-consumer Polyester

AN40 Birch	AN41 Green Apple	AN42 Lapis	AN43 Straw	AN44 Wolf	AN45 Goose	AN46 Angora
AN47 Cumin	AN48 Asteroid	AN49 Geranium	AN50 Thistle	AN51 Graphite	AN52 Slate	AN53 Quarry Blue
AN54 Onyx	AN55 Pumpkin	AN56 Red Delicious	AN57 Sunshine	AN59 Waterfall	AN61 Vanilla	AN62 Cobalt
AN64 Cloud						

Brinx 100% Polyester Designed to color coordinate with Lola and Mariposa panel fabrics.

BX01 Taupe	BX02 Caramel	BX03 Green Apple	BX04 Brick	BX05 Blue Steel	BX06 Bisque	BX07 Hot Chocolate
BX08 Golden						

Mariposa 100% Polyester Designed to color coordinate with Lola and Brinx panel fabrics.

MA41 Mocha	MA42 Blue Ocean	MA43 Claypot	MA44 Champagne	MA45 Granny Smith	MA46 Butterscotch	MA47 Mixed Taupe
MA48 Wheat						

Merge 100% Polyester / 75% Post-consumer Recycled Polyester

MG20 Fawn	MG21 Marshmallow	MG22 Driftwood	MG23 Dove	MG24 Graphite	MG25 Slate	MG26 Eucalyptus
MG27 Fire Engine	MG28 Mediterranean	MG29 Midnight				

GRADE 4

Accent 100% Polyester

GC31 Sand Dune	GC32 Limestone	GC33 Silver Mint	GC34 Skyway	GC35 Warm Beige	GC36 Mid-Grey	GC37 Green Olive
GC38 Cloud Blue	GC39 Desert Cactus	GC40 Cinder Block	GC41 Sage Brush	GC42 Brickworks		

FINISHES

Seating Finishes - Metal: Please consult each Seating Series for finish availability.

Black (BK)	Charcoal Grey (CHR)	Chrome (CH)	Fog (FG)	Polished Aluminum (ALU)	Tungsten (TUN)
------------	---------------------	-------------	----------	-------------------------	----------------

Seating + Table Finishes - Plastic (Duet, Duet Tables, Popcorn, Stream and Sonic)

Buzz Blue (BZB)	Cactus (CCT)	Carrot (CRO)	Cloud (IVC)	Dijon (DJN)	Eggplant (EGP)	Fog (FOG)
Frost (FRO)	Ink (INK)	Latte (LAB)	Night (BLK)	Sand (SND)	Scarlet (SAR)	Shadow (SHW)

Seating Finishes - Wood Seating finishes will not necessarily match laminate finishes. This is due to the fact that Seating and Desking finishes use different wood species and are manufactured at multiple locations.

Absolute (AAM)	Black (BKM)	Cherry (ACM)	Espresso Cafe (ECM)	English Oak (EOM)	Fruitwood (TFM)	Gray (HGM)
Honey (AHM)	Mahogany (TMM)	Maple (AVM)	Medium Walnut (MWM)	Night (ASM)	Shaker Cherry (SKM)	Walnut (TWM)
WC Cream (WTM)	White (WHM)	Winter Cherry (WCM)				

Desks, Workstations, Tables and Accessories - Laminate

Absolute Acajou (ACJ)	Asian Night (ASN)	Avant Cherry (AWC)	Avant Honey (AWH)	Black (BLK)	Brushed Cobalt (BRC)	Clear Maple (CMB)
Dark Espresso (DES)	Designer White (DWT)	Hayden Grey (HGT)	Quartered Mahogany (QTM)	Storm Grey (SOG)	Tiger Fruitwood (TFW)	Tiger Walnut (TWL)
Walnut Heights (WHE)	White Chocolate (WHC)	Willow Grey (WGY)	Winter Cherry (WCR)			

Desks, Workstations, Tables and Accessories - Wood Veneer

Almond Cherry (AMW)	Caramel Bamboo (BAMC)	Cocoa Walnut (CAW)	Coral (CRW)	Dark Cherry (DCW)	Espresso Walnut (EWW)	Evening Oak (EVW)
Grey on Oak (GRW)	Hazelnut (HAW)	Honey Maple (SMW)	Java (JAW)	Latte Walnut (LTW)	Milestone (MTW)	Mocha (MCW)
Natural Maple (MPW)	Red Cherry (RCW)	Vintage Cherry (VNW)	Walnut (WLV)	Warm Cherry (WCW)	White Maple (WMW)	

File + Storage Finishes

Black (BLK)	Business Grey (BGR)	Charcoal Grey (CGR)	Desert Putty (DPT)	Grey (GRY)	Light Grey (LGR)	Nevada (NEV)
Storm Grey (SGR)	Tahiti Sand (TSA)	Bone (F29)	Claret (F09)	Cloud (F23)	Designer White (DWT)	Ice (F33)
Ivory (F30)	Metro (F07)	Moss (F05)	Navy (F19)	Oyster (F35)	Stone (F32)	Tungsten 2 (TU2)
Willow (F28)						

File Finishes - Textured

Black Coffee (U04)	Dark Chocolate (T19)	Cappuccino (T20)	Mocha (J52)	Vanilla (J23)
--------------------	----------------------	------------------	-------------	---------------

TEXTILES + FINISHES - LAMINATE FINISH CHART

FINISH CODE:	ACJ	ASN	AWC	AWH	BLK	BRC	CMB	DES	DWT	HGT	QTM	SOG	TFW	TWL	WHC	WHE	
LAMINATE DESKING																	
Adaptabilities	•	•	•	•	•	•	•	•	•	•	•	•	•	•	•	•	
Genoa	•	•	•	•	•	•	•	•	•	•	•		•	•	•	•	
Halton	•	•	•	•	•	•	•	•	•	•	•	•	•	•	•	•	
Princeton	•	•	•	•			•	•	•	•				•	•	•	
Zira	•	•	•	•	•	•	•	•	•	•	•	•	•	•	•	•	
METAL DESKING																	
StreamLINE II	•	•	•	•	•	•	•	•	•	•	•	•	•	•	•	•	
BENCHING																	
Bridges II	•	•	•	•	•*	•*	•	•	•	•*		•*	•	•	•	•	
FreeFit	•	•	•	•	•	•	•	•	•	•	•	•	•	•	•	•	
Intelli Beam	•	•	•	•	•	•	•	•	•	•	•	•	•	•	•	•	
Sidebar	•	•	•	•	•	•	•	•	•	•	•	•	•	•	•	•	
PANELS + COMPONENTS																	
Divide	•	•	•	•	•	•	•	•	•	•	•	•	•	•	•	•	
TABLES - MEETING + CONFERENCE																	
Alba	•	•	•	•	•	•	•	•	•	•	•	•	•	•	•	•	
Boardroom	•	•	•	•	•	•	•	•	•	•	•	•	•	•	•	•	
Bungee + Bungee SL	•	•	•	•	•	•	•	•	•	•	•	•	•	•	•	•	
Connectables	•	•	•	•	•	•	•	•	•	•	•	•	•	•	•	•	
Junction	•	•	•	•	•	•	•	•	•	•	•	•	•	•	•	•	
Kadin	•	•	•	•	•	•		•	•	•		•		•	•	•	
Swap	•	•	•	•	•	•	•	•	•	•	•	•	•	•	•	•	
Terina	•	•	•	•	•	•	•	•	•	•	•	•	•	•	•	•	
Zira Boardroom	•	•	•	•	•	•	•	•	•	•	•	•	•	•	•	•	
TABLES - RECEPTION + OCCASIONAL																	
Citi	•	•	•	•	•	•	•	•	•	•	•	•	•	•	•	•	
Laminate Occasional Tables	•	•	•	•	•	•	•	•	•	•	•	•	•	•	•	•	
Reception Tables	•	•	•	•	•	•	•	•	•	•	•	•	•	•	•	•	
Rectangular Work Tables				•										•			
Sirena Tables	•	•	•	•			•	•	•	•				•	•	•	
Wind Tables	•	•	•	•	•	•	•	•	•	•	•	•	•	•	•	•	
TABLES - TRAINING																	
2gether	•	•	•	•	•	•	•	•	•	•	•	•	•	•	•	•	
TABLES - HEIGHT ADJUSTABLE																	
Height Adjustable Tables	•	•	•	•	•	•	•	•	•	•	•	•	•	•	•	•	
FILING + STORAGE																	
Lateral File Tops	•	•	•	•	•	•	•	•	•	•	•	•	•	•	•	•	
WOOD VENEER DESKING																	
Corby - Laminate chassis	•	•			•		•	•	•	•		•			•	•	
Dufferin - Laminate chassis					•				•	•		•					

* Bridges II finishes coordinate with metal paint finishes as follows: Black (BLK) - Black Paint (BLK); Brushed Cobalt (BRC) - Tungsten Paint (TUN); Hayden Grey (HGT) - Taupe Paint (TPE); Storm Grey (SOG) - Charcoal Paint (CHR); Designer White (DWT) - Designer White Paint (DWT); Custom Grey (CGY) - Silver Paint (SIL); String (STG) - Nevada Paint (NEV).

	WGY	WCR	CGY	STG
	•	•		
	•	•		
	•	•		
		•		
	•	•		
	•	•	•	•
	•	•	•	•
		•		
	•	•		
	•	•		
	•	•		
	•	•		
	•	•		
	•	•		
	•	•		
	•	•		
	•	•		
	•	•		
	•	•		
		•		
	•	•		
		•		
	•	•		
	•	•		
	•	•		
		•	•	•
			•	•

LAMINATE FINISHES COORDINATION CHART			
LAMINATE FINISH		COORDINATING WOOD FINISH	
ACJ	Absolute Acajou	AAM	Absolute
ASN	Asian Night	ASM	Night
AWC	Avant Cherry	ACM	Cherry
AWH	Avant Honey	AHM	Honey
BLK	Black	BKM	Black
CMB	Clear Maple	AVM*	Maple
DES	Dark Espresso	ECM	Espresso Cafe
DWT	Designer White	WHM	White
HGT	Hayden Grey	HGM	Grey
QTM	Quartered Mahogany	TMM	Mahogany
TFW	Tiger Fruitwood	TFM	Fruitwood
TWL	Tiger Walnut	TWM	Walnut
WCR	Winter Cherry	WCM	Winter Cherry
WHC	White Chocolate	WTM	WC Cream
WHE	Walnut Heights	MWM	Medium Walnut
LAMINATE FINISHES WITH NO COORDINATING WOOD FINISHES		WOOD FINISHES WITH NO COORDINATING LAMINATE FINISHES	
BRC	Brushed Cobalt	EOM	English Oak
SOG	Storm Grey	SKM	Shaker Cherry
WGY	Willow Grey		
CGY	Custom Grey		
STG	String		

THINK GLOBAL/THINK GREEN



LEVEL 3 CERTIFIED
Many programs in various categories



LEED PARTNERSHIP PROGRAM
Products can help you earn credits



GREENGUARD CERTIFIED
Children & Schools Certified

THE ENVIRONMENT We believe now more than ever, that it is our responsibility to protect the environment and our precious natural resources for future generations. The growing importance of energy and environmental concerns continues to challenge us in this ever changing marketplace.

As an industry leader, Global continues to take proactive steps towards reducing the negative impacts on the environment. We are building "healthier" offices; investing in Research & Development and new technologies; reducing waste and the consumption of energy; and improving the quality of the air we breathe, all which can have a significant impact on our quality of life.



Epoxy Powder coating process is solvent free. No harmful VOC's or lead. No toxins are released into the atmosphere.

Global's recycled fabrics offer affordable, environmentally responsible alternatives to commercial textiles. We recycle 35,000 lbs of fabric offcuts weekly.



powder paint process:
98% paint recovery and reuse

more recycled fabric
less to the landfill

talk to us about our
leed partnership program

we've diverted
90% of our wood waste from landfill in four years



Global has the products and resources to help your projects achieve LEED certification.

New technology allows us to reduce glue usage by 50%. In addition, our polyurethane glue reduces emissions and requires less energy to apply.



For further information on Global's environmental initiatives, please visit <https://www.globalfurnituregroup.com/us/company/environmental-commitment>



CUSTOM GROMMET LOCATION FORM

Model # _____ (Please use one page for each model #)

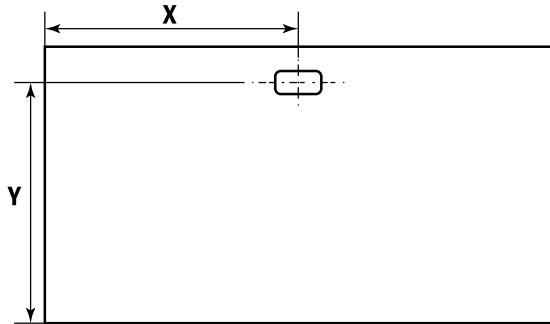

Operator Side

Template for Tops

X = _____

Y = _____

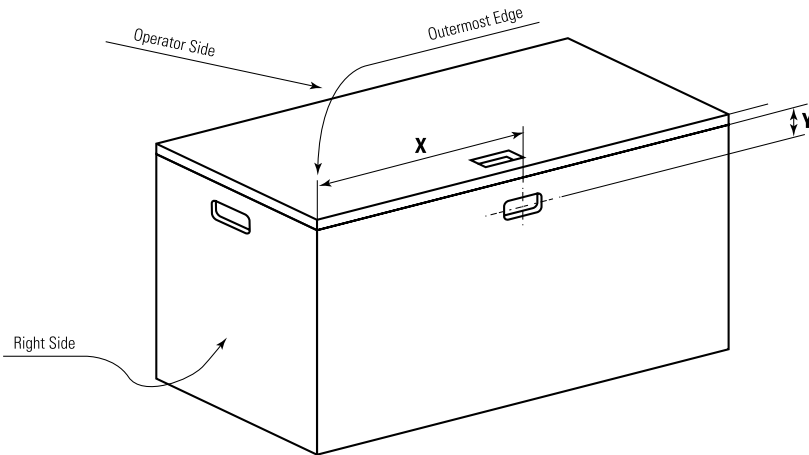
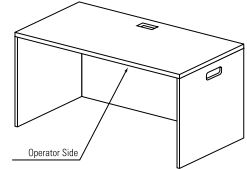

Template for Modesty Panels

X = _____

Y = _____

Note: X = Taken from outermost edge

Note: Y = Taken from underside of top

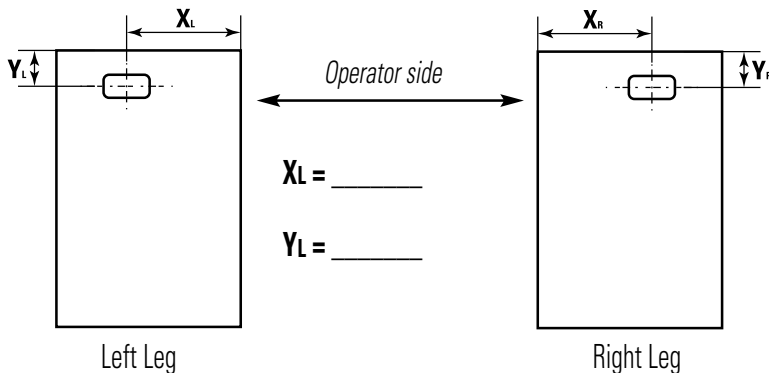

Left Leg

Right Leg

X_L = _____

Y_L = _____

Template for Legs

X_R = _____

Y_R = _____

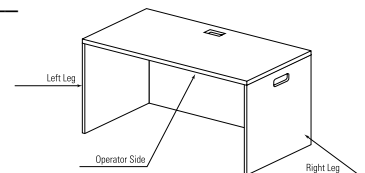

THIS FORM IS TO BE USED FOR NON-STANDARD CUT-OUT SIZES

Zira boardroom tables only (96" table)

Model # _____ (please use one page for each model #)

Please check all that apply. Note: Shaded grey areas represent position of bases.

CUT-OUT POSITION(S)

- Position 1 - over left base - always 24.6" to center point of cut-out from left edge - use option code **CCU1**
- Position 2 - center of table - use option code **CCU2**
- Position 3 - over right base - always 24.6" to center point of cut-out from right edge - use option code **CCU3**
- Custom position(s) - indicate on diagram below w/dimensions to **center point** of cut-outs - use option code **CCUS**

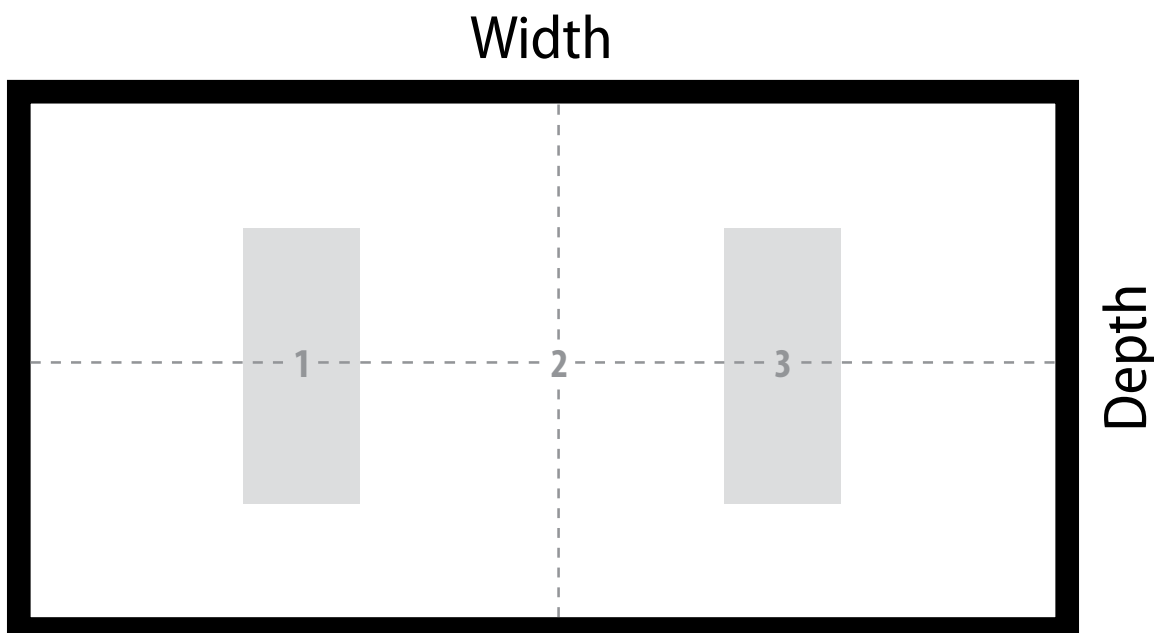

CUT-OUT CRITERIA

All cut-outs require a minimum 8mm radius at each corner.

Cut-outs **must be centered** on the depth of each table due to wire management runners below the worksurface.

Power and data modules that extend more than 3.75" below the worksurface **CANNOT** be positioned over bases.

Indicate cut-out size:

_____ " X dimension of cut-out runs the width of the table.

_____ " Y dimension of cut-out runs the depth of the table.
Y dimension not to exceed 14"

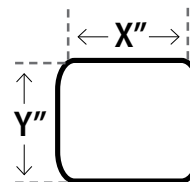

Dealer PO# _____

Internal use only

Global order# _____

Global trailer/load #: L _____ ID #: _____

www.FilingToday.com

sales@filingtoday.com

1-888-891-1970

globalfurnituregroup.com



THIS FORM IS TO BE USED FOR NON-STANDARD CUT-OUT SIZES

Zira boardroom tables only (120" - 168" table)

Model # _____ (please use one page for each model #)

Please check all that apply. Note: Shaded grey areas represent position of bases.

CUT-OUT POSITION(S)

- Position 1 - over left base - always 25.2" to center point of cut-out from left edge - use option code **CCU1**
- Position 2 - center of table - use option code **CCU2**
- Position 3 - over right base - always 25.2" to center point of cut-out from right edge - use option code **CCU3**
- Custom position(s) - indicate on diagram below w/dimensions to **center point** of cut-outs - use option code **CCUS**

Width

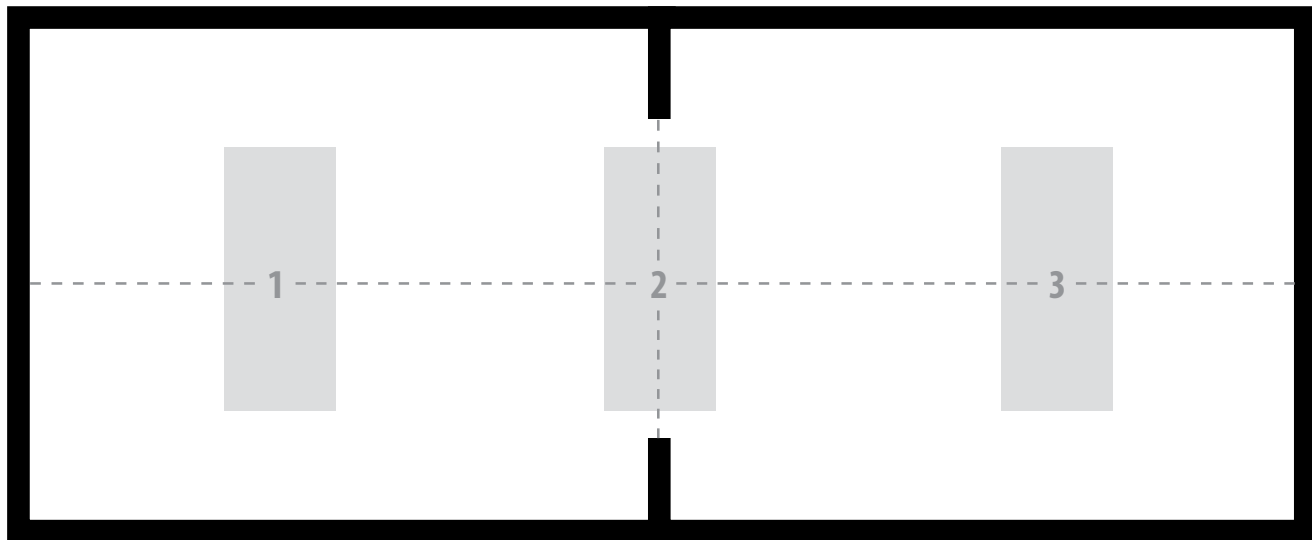

CUT-OUT CRITERIA

All cut-outs require a minimum 8mm radius at each corner.

Cut-outs **must be centered** on the depth of each table due to wire management runners below the worksurface.

Power and data modules that extend more than 3.75" below the worksurface **CANNOT** be positioned over bases.

Indicate cut-out size:

_____ " X dimension of cut-out runs the width of the table.

_____ " Y dimension of cut-out runs the depth of the table.

Y dimension not to exceed 14"

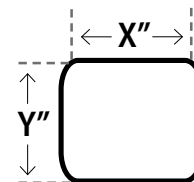

Dealer PO# _____

Internal use only

Global order# _____

Global trailer/load #: L _____ ID #: _____

www.FilingToday.com

sales@filingtoday.com

1-888-891-1970

globalfurnituregroup.com



THIS FORM IS TO BE USED FOR NON-STANDARD CUT-OUT SIZES

Zira boardroom tables only (192" - 288" table)

Model # _____ (please use one page for each model #)

Please check all that apply. Note: Shaded grey areas represent position of bases.

CUT-OUT POSITION(S)

- Position 1 - over left base - always 25.2" to center point of cut-out from left edge - use option code **CCU1**
- Position 2 - center of table - use option code **CCU2**
- Position 3 - over right base - always 25.2" to center point of cut-out from right edge - use option code **CCU3**
- Custom position(s) - indicate on diagram below w/dimensions to **center point** of cut-outs - use option code **CCUS**

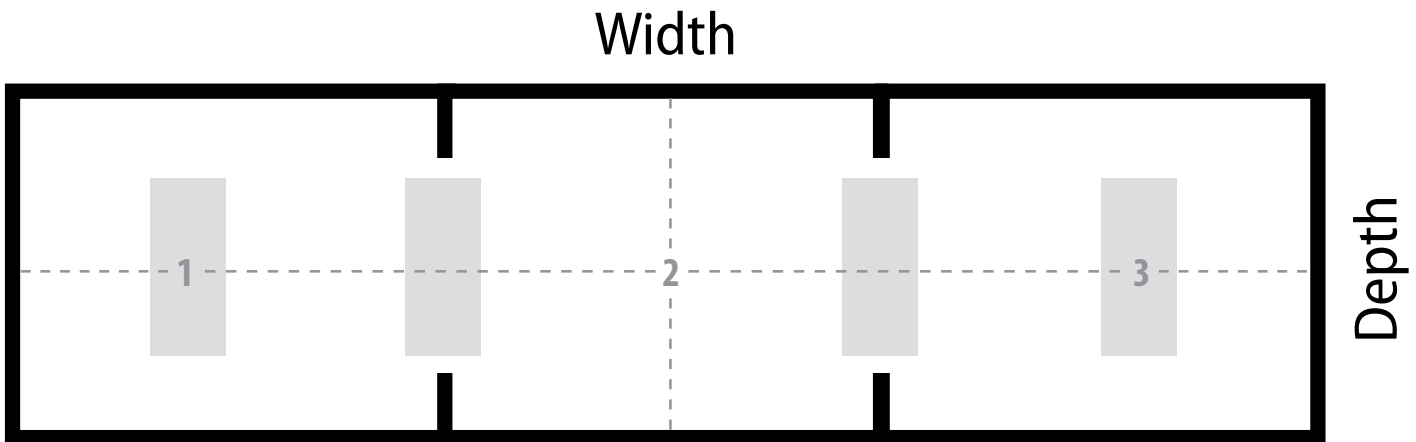

CUT-OUT CRITERIA

All cut-outs require a minimum 8mm radius at each corner.

Cut-outs **must be centered** on the depth of each table due to wire management runners below the worksurface.

Power and data modules that extend more than 3.75" below the worksurface **CANNOT** be positioned over bases.

Indicate cut-out size:

_____ " X dimension of cut-out runs the width of the table.

_____ " Y dimension of cut-out runs the depth of the table.

Y dimension not to exceed 14"

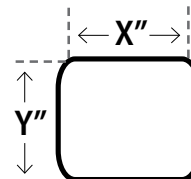

Dealer PO# _____

Internal Use Only

Global Order# _____

Global Trailer/Load #: L _____ ID #: _____

www.FilingToday.com

sales@filingtoday.com

1-888-891-1970

globalfurnituregroup.com

global

THIS FORM IS TO BE USED FOR NON-STANDARD CUT-OUT SIZES

Zira boardroom tables only (square tables)

Model # _____ (please use one page for each model #)

Please check all that apply. Note: Shaded grey area represents position of base.

CUT-OUT POSITION(S)

Position 2 - center of table - use option code **CCU2**

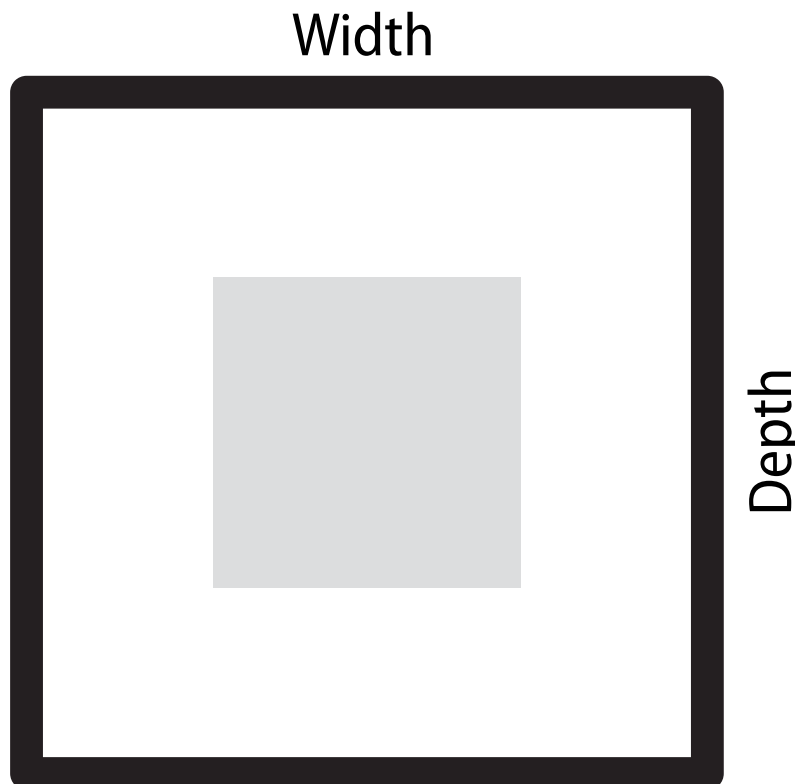

CUT-OUT CRITERIA

All cut-outs require a minimum 8mm radius at each corner.

Cut-outs **must be centered** on the depth of each table.

Power and data modules that extend more than 3.75" below the worksurface **CANNOT** be positioned over bases.

_____ " X dimension of cut-out runs the width of the table.

_____ " Y dimension of cut-out runs the depth of the table.
Y dimension not to exceed 11"

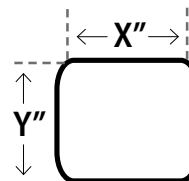

Dealer PO# _____

Internal use only

Global order# _____

Global trailer/load #: L _____ ID #: _____

www.FilingToday.com

sales@filingtoday.com

1-888-891-1970

globalfurnituregroup.com



THIS FORM IS TO BE USED FOR NON-STANDARD CUT-OUT SIZES

Zira media tables only

Model # _____ (please use one page for each model #)

Please check all that apply. Note: Shaded grey area represents position of base.

CUT-OUT POSITION(S)

Position 1 - over left base - always 24.6" to center point of cut-out from left edge - use option code **CCU1**

Custom position(s) - indicate on diagram below w/ dimensions to **center point** of cut-outs - use option code **CCUS**

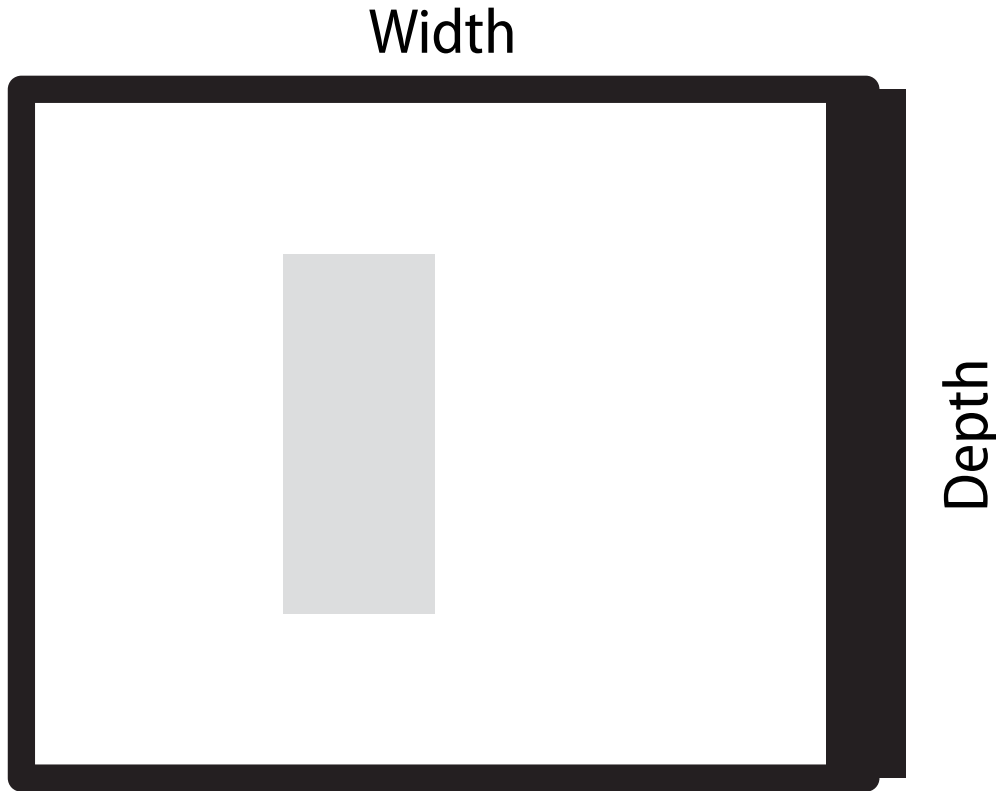

CUT-OUT CRITERIA

All cut-outs require a minimum 8mm radius at each corner.

Cut-outs **must be centered** on the depth of each table due to wire management runners below the worksurface.

Power and data modules that extend more than 3.75" below the worksurface **CANNOT** be positioned over bases.

_____ " X dimension of cut-out runs the width of the table.

_____ " Y dimension of cut-out runs the depth of the table.
Y dimension not to exceed 14"

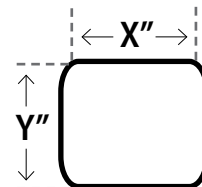

Dealer PO# _____
www.FilingToday.com

Global order# _____

Internal use only
sales@filingtoday.com

Global trailer/load #: L _____ ID #: _____

1-888-891-1970

THIS FORM IS TO BE USED FOR NON-STANDARD CUT-OUT SIZES

Zira collaborative tables only

Model # _____ (please use one page for each model #)

Please check all that apply.

CUT-OUT POSITION(S)

- Position 1 - always 24.6" to center point of cut-out from left edge - use option code **CCU1**
- Position 2 - center of table - use option code **CCU2**
- Position 3 - always 24.6" to center point of cut-out from right edge - use option code **CCU3**
- Custom position(s) - Please indicate on diagram below with dimensions to **center point** of cut-outs - use option code **CCUS**

Width

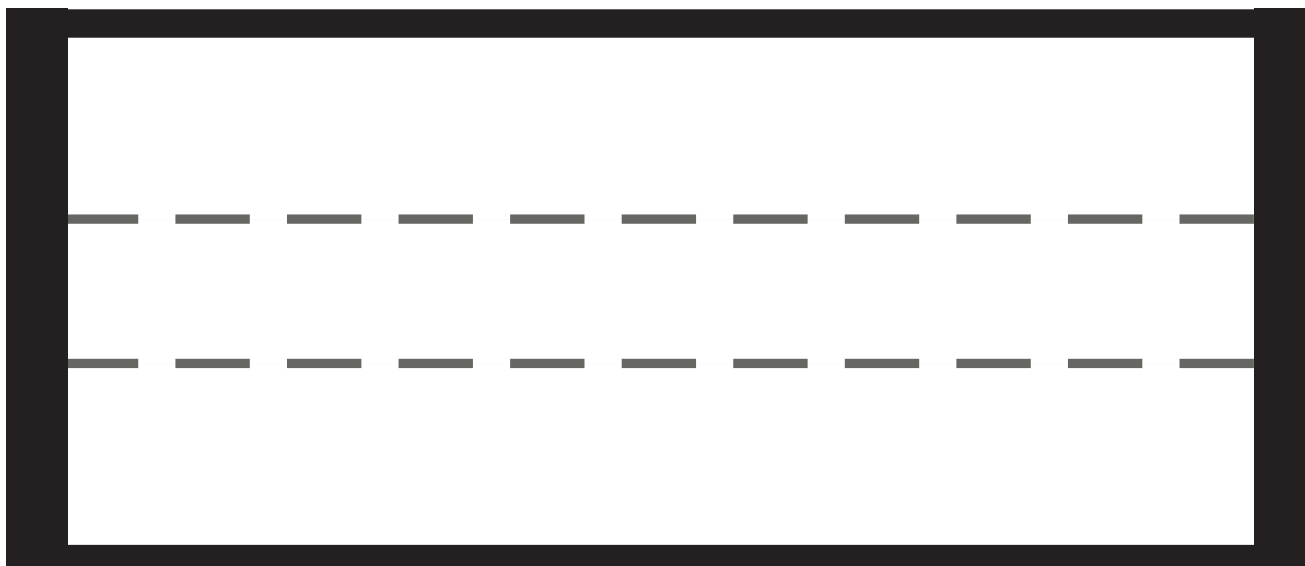

Depth

CUT-OUT CRITERIA

All cut-outs require a minimum 8mm radius at each corner.

Cut-outs **must be centered** on the depth of each table due to wire management runners below the worksurface.

_____ " X dimension of cut-out runs the width of the table.

_____ " Y dimension of cut-out runs the depth of the table.
Y dimension not to exceed 10"

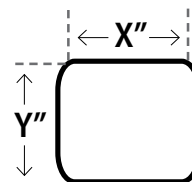

Dealer PO# _____

Internal use only

Global order# _____

Global trailer/load #: L _____ ID #: _____

www.FilingToday.com

sales@filingtoday.com

1-888-891-1970

globalfurnituregroup.com



TERMS & CONDITIONS

This illustrated price list has been designed to facilitate fast reference and easy use. All products are categorized into "seating", "desks", "files", "panels", "tables" and "modular furniture", and are listed numerically within their categories. The line drawings match actual photographs (where possible) to aid in instant recognition of the total range within a series.

Sales of Global-The Total Office ("Global") products are made only on Global's standard terms and conditions of sale which are contained in this Price Book. These standard terms and conditions may be modified or supplemented only by a separately written document signed by Global's authorized personnel at its head office in Marlton, NJ. Any term or condition contained in any purchase order or other form used by dealer/purchaser to order goods (including standard, printed language) which is different from, in addition to, or in any way inconsistent with Global's standard terms and conditions shall be of no force or effect whatsoever.

All illustrations, specifications and prices in this book are based on the latest product information available at the time of publication. Global reserves the right to make changes, at any time and without prior notice, to prices, colors, materials, specifications and models offered.

Description

Each product shown or described in this price list is standard Global product. Variations are noted at the beginning of each series. Any variations from what is standard may require additional delivery time and cost and may affect the warranty given. Sizes and weights shown are approximate and are subject to slight changes from time to time.

Prices and Payment

The prices shown in this book, as well as those quoted by Global, are in United States dollars for orders shipped to destinations in the U.S. and Mexico.

If shipping date requested is more than 90 days from date of order, Global shall have the right to use published list prices effective at the time of shipment.

Orders are invoiced at the time of shipment. Terms of payment are net 30 days from date of invoice (1% 15 days) unless otherwise stated. The customer agrees that Global shall have the right to enforce a charge amounting to 1.5% per month (18% per year) on invoices outstanding more than 30 days.

If dealer/purchaser's most recent annual net volume is less than \$5,000.00, payment must be made in advance.

Any products sold by Global shall remain the personal property of Global until fully paid.

Prices are suggested list prices only and are subject to change without notice. Global will, however, attempt to keep dealer/purchasers up-to-date on all developments including price changes.

Taxes

All prices shown in this book are exclusive of sales, use, excise and other applicable taxes and are the dealer/purchaser's responsibility as per the invoice issued by Global. If dealer/purchaser claims an exemption from such taxes, it shall be the dealer/purchaser's responsibility to furnish Global with an appropriate exemption certificate at time of order.

Ordering Information

To avoid errors and/or duplication Global requires that all orders be submitted in writing. All orders submitted to Global in writing will be acknowledged on Global's acknowledgement forms governing the transaction. The details appearing on this acknowledgement will describe the items to be shipped and the approximate shipping date. It is the dealer/purchaser's responsibility to determine that the information in the acknowledgment is correct. In the event of an error, the dealer/purchaser must notify Global immediately by telephone followed by written confirmation. Shipping dates are assigned to orders based on the item having the longest manufacturing lead time.

When ordering, please provide the following information:

- 1) Account number (if possible)
- 2) P.O. number
- 3) "Bill to" and "ship to" name and address
- 4) Complete model number
- 5) Description
- 6) Options:
 - a. Upholstery fabric type and color (specify by name and number)
 - b. Color of paint finish, laminate or wood (if applicable)
 - c. Trim options (frame)
 - d. Arms
 - e. Base, Casters
 - f. Mechanism
 - g. Accessories

Dealer/purchaser is responsible for providing correct information when placing an order. Orders with incorrect information (finish, etc.) will be scheduled for manufacturing upon receipt of complete information.

All phone orders must be confirmed in writing by the customer within 7 days.

To prevent a delay in processing orders, please specify delivery routing.

Changes and Cancellations

After the date of Global's acknowledgment of a dealer/purchaser's order, the order may not be changed or cancelled by dealer/purchaser without the written consent of Global. Special order items, C.O.M. and fabric-covered items already in production are not subject to change or cancellation under any circumstances. Fabric-covered items are considered to be in production once the fabric is scheduled for cutting. Other standard items already in production are subject to a minimum 35% cancellation charge.

Errors and Omissions

All quotations, acknowledgements and invoices are subject to corrections for any errors and omissions.

FINISHES

Seating Finishes

Where painted frames are not a standard color, there is a one time charge of \$578.00 list price per-order for custom wood staining/color matching. Restrictions may apply. The customer must provide a 3" x 3" color chip/sample. Non-standard finishes must be approved by Global prior to acceptance of order.

File Finishes

All non-standard finishes must be approved by Global prior to acceptance of order and may be subject to an upcharge.

Laminated Tops - Pricing for all non-standard finishes and sizes must be provided by Global Customer Service and may be subject to an upcharge.

Desk Finishes

Because the distinctive characteristics and the nature of wood products cause variations, exact matches are not always possible.

Global has launched a finishes program between marketing companies within the Global Group to match products as best as possible when same finishes are specified.

C.O.M. (Customers Own Material)

Use of Customer's Own Material must be approved by Global prior to acceptance of order. Please refer to back of the Seating List Price Book and fill out the Authorization Request Form. Photocopy and use this form as often as necessary. The customer must provide a 12" x 12" fabric sample and advise how the fabric is to be applied. **Fabric yardage requirement will be advised by the factory, and additional yardage may be required if pattern requires matching.** Yardage shown in the List Price Book does not allow for pattern repeat/matching. Send to the address provided on shipping document upon approval from Global. If C.O.M. is difficult to apply or if product shall be modified, extra charges shall be made. Global reserves the right to cancel an order at any time if C.O.M. is inadequate for any reason. Customer's Own Material must be shipped freight and duties paid to our factory. Such shipment must be fully identified with purchaser's order number, RGA # provided by Global, and the item for which material is intended. Performance of C.O.M. when applied to product is the sole responsibility of the purchaser. Global's standard product warranty shall not apply to C.O.M. Use of C.O.M. will not reduce the published list price.

Textile Grading

All products are priced according to their standard fabric and fabric grade. Lower grade fabrics are available (unless otherwise specified) at same price as standard.

The listing of prices for each model indicates the prices for higher upholstery grades. Prices are based on yardage in imperial measurements.

TEXTILE PRICE GRADES - GLOBAL TEXTILES

Grade	Upholstery (Seating Fabrics)
1	Carrera, Fusion, Hudson, Jenny, Mock Leather, Quilt, Terrace, Urban, Waterfall
2	Allante FRee, Crescent, Elevate, Etch, GC Linen, Imprint, Match, Release, Renewal, Replay, Silhouette
3	Couture
5	Leather/Mock Leather Combination
8	Genuine Leather

Grade	Upholstery (Panel Fabrics)
1	Agate II,
2	Coordinate, Lola
3	Accent, Anchorage, Brinx, Mariposa

The charts above do not include Textiles offered by Alliance Partners: Arc-Com Fabrics, CF Stinson, Designtex, Knoll Textiles, Green Hides, LDI, Luum Textiles, Maharam, Mayer Fabrics, Momentum, and Ultrafabrics.

Upholstery Coverings

Slight variations in color may occur between dye lots. Although Global attempts to minimize these variances, they do occur and must be accepted as normal and will not be considered defects.

Yardage

Required yardage (ydg) is based on unmatched materials with widths of 54" for seating. Yardage calculations are based on imperial measurements.

Arms

A wide selection of arms are available for some series. See Arm Charts for details.

Delays

Global's shipping confirmation will state a shipping date which is Global's best estimate at the time the order is acknowledged. However, Global shall not incur any obligation or liability to Purchaser for failure to ship by specified date unless Global has agreed to an unequivocal shipping date in a separately signed written document executed by its authorized personnel at its head office. In addition, Global shall not be liable for any loss or damage resulting from any delay or failure in shipment or other failure to perform all or any part of the agreement between the parties with respect to the goods shown on the face of the order acknowledgement where such delay, failure, loss or damage is the proximate result of any act of any governmental authority or political subdivision thereof, revolution, riot, civil disorder or disturbance, delay or default in transportation, strike disputes among or between labor unions or other labor disputes, delay or inability in obtaining materials and facilities, fire, flood, act of God or any cause not within the reasonable control of the company, whether of the class of causes enumerated or otherwise.

F.O.B.

F.O.B. point is Global's Factory, Downsview, Ontario, Canada, or any Global Regional Distribution Center.

UPS Shipments

Seating products marked with a UPS symbol are packaged for UPS-able shipments.

Handling

A \$25. net handling charge per shipment will be applied for non UPS-able orders of less than \$2000. list.

Special Delivery Requirements

Global's delivered pricing provides for dock delivery during normal business hours (considered to be 8 am to 4 pm Monday through Friday) to customer/end user only. Additional delivery requirements such as inside delivery, lift gate, limited access sites, installations and weekend deliveries will incur an additional expense and will be the responsibility of the dealer.

Service

Service requests are normally the responsibility of Global's authorized dealers. Where this cannot be accomplished on a local level, service problems should be referred to Global's Customer Service Department in the nearest distribution center.

Returns

No returns of goods will be accepted without written consent and shipping instruction of Global. A minimum re-stocking charge of 35% is made on all authorized returns for credit or refund, provided goods are received by Global in the condition in which they left the factory. This

may increase depending on the type of product. Global's Return Goods Authorization (R.G.A.) numbers must appear prominently on all authorized returns. Global will not be responsible for freight costs. No credit will be given if goods cannot be reused as new. Special order items, non-stock items and C.O.M. products are in no event subject to return. All returns must be approved and authorized in writing by Global Customer Service. Global reserves the right to refuse delivery of any unauthorized returns.

Claims

All goods are sold F.O.B. plant or Global Distribution Center. Global is not responsible for damage which occurs in transit (or in storage). The carrier signs for all goods received in apparently good order. It is the dealer/purchaser's responsibility to examine goods upon receipt and to file any claims with the carrier for losses or damage to the product occurring during transit, including concealed damage.

Any claims made against Global for apparent defects, errors or shortages must be made by the dealer/purchaser, in writing, within 15 working days after any delivery. Failure by the dealer/purchaser to make any claim against Global within 15 days shall constitute acceptance of the goods and a waiver of any apparent defects, errors or shortages.

Suspension

In the event that the dealer/purchaser defaults in the payment of any sum due to Global, or in the event the dealer/purchaser's financial condition becomes unsatisfactory to Global, Global shall have the right to defer or discontinue shipment of any goods until such time as the default is cured or the dealer/purchaser provides assurance of payment to Global.

Copyright

All catalogs, photographs, drawings, price lists and other printed material are protected by copyright. All rights reserved.

Trademarks

All trademarks are owned by Global Furniture Group other than OBUSFORME™ which is owned by OBUSFORME LTD. and are used under license. OBUSFORME® and the distinctive backrest design are registered trademarks of OBUSFORME LTD.

Designs and Patents

Many of the products produced by Global are protected by design registrations, design patents and/or patents. Design and specifications are subject to change, discontinuance or additions without notice.

Cubic Measure

The stated cubage is an approximate cubic foot measure to calculate freight costs. The figure shown is the volume for one carton and is subject to change without notice. It is most economical to purchase the specified number per carton.

Combined Shipments

Global will make every effort to combine shipments and orders on written request. However, Global cannot be held responsible where such request is not complied with.

Offer of Sale

Possession of this price list or any other literature shall not imply the company's willingness to sell to the holder and shall not be construed as a direct offer of sale.

If a conflict arises between: (i) prices found in software support packages furnished to the customer by Global or by any other source on behalf of Global; and (ii) Global's current printed price lists, then the most current shall prevail.

Disclaimer

All dimensions are in inches. Prices shown are current manufacturer's suggested list prices at the time of printing. All applicable taxes are extra. Descriptions, specifications and prices are subject to change without notice. Errors and omissions are subject to correction.

Flammability

The foam used in Global chairs meets the requirements of California TB117:2013. In addition to the foam, upholstery materials must also meet the California TB117 smolder resistant requirements. Please contact Customer Care to determine if a selected textile meets the California TB117 requirement.

This list price book is effective as of March 1, 2019.

For periodic updates, please check the PDF at www.globalfurnituregroup.com. Global warrants that all commercial products are free from defects in material and workmanship, for the life of the product, to the original purchaser.

LIFETIME WARRANTY

Global will repair or replace, at Global's option, as the sole remedy for any defect covered by the warranty. The warranty applies to products manufactured after January 1, 2011.

General Commercial Seating

Global's warranty for general commercial seating covers all chair components including pneumatic cylinders, bases, casters, glides, frames, arms, plastic seats, backs and other structural components.

Exceptions to the warranty for general commercial seating are as follows:

- Foam, textiles (as sampled on Global branded and textile program cards), mesh material and electrical devices, are warranted for five (5) Years
- Control mechanisms are warranted for twelve (12) Years

The warranty applies to single shift, standard commercial usage, defined as a standard eight (8) hour day, forty (40) hour week for users weighing up to 300 pounds. ObusForme Comfort XL falls under the General Commercial Seating Warranty with the exception the weight rating is for users up to 400 pounds.

Heavy Duty Seating

Global offers products designed for multiple shift applications (24 hours a day / 7 days a week) and larger individuals weighing up to 350 and/or 500 pounds (depending on series and/or model). Global warrants these products for twelve (12) years to the original purchaser. All components (including control mechanisms, pneumatic cylinders, bases, casters, glides, frames, arms, plastic seats/backs, etc.) are covered for 24/7 applications under the warranty. The exceptions are foam and textiles, which are covered for five (5) years. Textiles on these products must exceed 100,000 double rubs for the textile portion of the warranty to apply. Heavy Duty product series that apply under this warranty currently include: Concord Executive 24 hour, Dexter/Dexter+, Granada TS, Granada Deluxe TS, Malaga TS, ObusForme Comfort TS, River HT, Robust, Saxon, Truform TS and Vion TS.

Textiles

Global warrants Global branded textiles and Alliance Partner carded textile programs inclusive of fabrics, vinyls and leather products for five (5) years. Alliance Partner carded textile programs are currently with Arc-Com Fabrics, CF Stinson, Designtex, Knoll Textiles, Green Hides, LDI, Lumm Textiles, Maharam, Mayer Fabrics, Momentum, and Ultrafabrics. Global does not warrant COM (Customer Own Materials) or graded-in materials (non-carded) and purchased by Global for a customer. For graded-in or COM products, please contact the textile supplier for performance information and warranty details.

Seating Warranty Summary

Seating Type	Components Warranty For Original Purchaser	Use Time For Warranty Coverage	Exceptions
General Commercial Seating	Lifetime	8 Hours/5 Days Per Week	Foam/Textiles/Mesh/Electrical Devices - 5 Years Control Mechanisms - 12 Years
Heavy Duty Seating	12 Years	24 Hours/7 Days Per Week	Foam/Textiles - 5 Years

Files, Desks, Modular Furniture, Tables, Panels & Accessories

Global warrants all components of metal storage and filing, laminate and wood veneer desks, laminate and wood veneer tables, metal leg components and panels for the lifetime of the product to the original purchaser.

Exceptions to the warranty for Files/Desks/Tables and Panels are as follows:

- Electrical devices, panel and tackboard textiles, adjustable keyboard mechanisms/lecterns/coat trees and task lights – five (5) Years
- Folding tables (laminate and Lite Lift II models) – one (1) Year

Files, Desks, Modular Furniture, Tables, Panels & Accessories Warranty Summary

Product Type	Components Warranty For Original Purchaser	Exceptions
Metal Storage and Filing	Lifetime	None
Laminate/Wood Veneer Desks and Modular Furniture	Lifetime	Tackboard Textiles , Electrical Devices,Task Lights - 5 Years
Productivity Solutions - Foli + FreeFit Height Adjustable Tables	Lifetime	Steel components - 10 Years, Moving components - 5 Years, All electrical components - 2 Years
Boardroom, Conference and Training Tables	Lifetime	Electrical Devices - 5 Years
Panels	Lifetime	Panel Textiles, Electrical Devices, Task Lights - 5 Years
Coat Racks and Lecterns	5 Years	None
Folding Tables (Laminate & Molded)	1 Year	None

Global's Warranty does not apply (for any product category) to the following:

- Failures due to wear and tear
- Failures which result from negligence, abuse, accident or misuse
- Failure to apply, install or maintain products according to Global's written instructions and warnings
- Modifications, attachments or repair methods not approved by Global
- Damage caused by a carrier in transit, or delivery/installation contractors
- The matching of colors, grains or textures (wood, leather, etc.) of natural materials and color matching of textiles
- Products exposed to extreme hot or cold temperatures or excessively dry or humid environments
- Colorfastness or the matching of color of textiles
- Damage by markings or staining; damage by sharp objects or imprinting from instruments
- Damage to textiles or laminate and wood surfaces/edges from exposure to sunlight (including UV rays)
- Products used for rental purposes

Global's warranty does not cover the costs of transportation or labor. Repair or replacement will be at Global's option.

Global makes no warranty that any of its products are suitable for any particular purpose and makes no other warranties, express or implied, other than those set out here. As codes and standards vary from one jurisdiction to another, references to compliance are solely for convenience and without any representation as to accuracy or suitability. Users must verify the suitability of such information or product for their specific application. In no event shall Global be liable in either tort or contract for any loss or direct, special, incidental, consequential, or exemplary damages.

Global's warranty applies to products sold within the United States of America, Mexico, the Commonwealth of Puerto Rico and Canada.