



COMMERCIAL PRICE LIST  
AND SPECIFICATIONS  
EFFECTIVE APRIL 1, 2023





# NEOCON NEW PRODUCT INTRODUCTIONS

HOME → NEOCON 2021

Below are Magnuson Group's newest product introductions, on display each year in Chicago at NeoCon in the Merchandise Mart. Click on a product to learn more and access specification details.

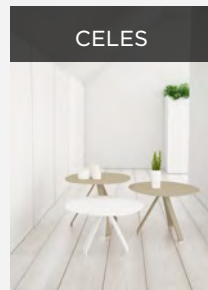
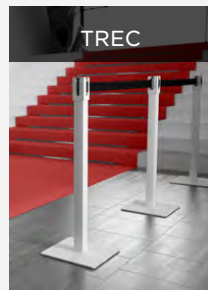
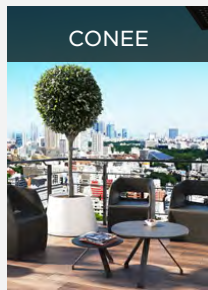
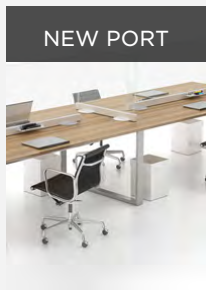
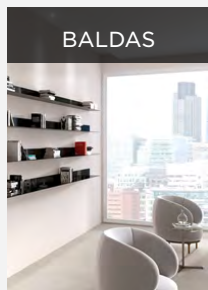
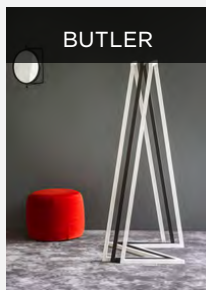
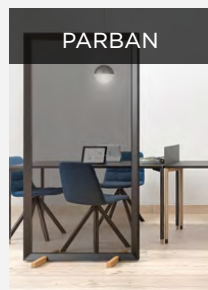
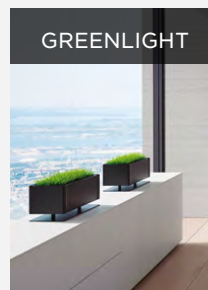
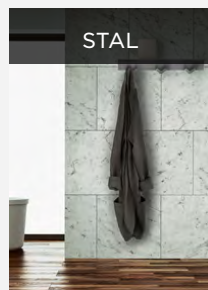
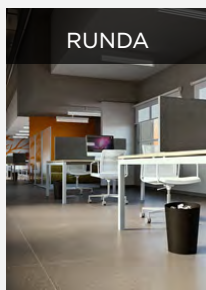



# Magnuson *Makes It Easy*

## Online Resources



Product Information – Find images, inspiration and more on our website.



Price List – Find US & Canadian pricing online; GSA Advantage & NCPA pricing also available.



Product Animations – These short, catchy videos bring our products to life –check them out!



Downloadable PDFs – Download or share Price Lists, Quick Reference Guide or Product Overview PDFs



Pinterest – Our Pinterest site has high-resolution images, install shots and inspiration for your office!



CAD & Revit Symbols – Request CAD or Revit symbols on our website for space planning.

## Factory Resources



Product Samples – Order discounted product samples for your evaluation and use.



Merchandise Mart Showroom – If you're in Chicago, make an appointment to come see us!



Customer Service – Our friendly, helpful & knowledgeable staff is standing by to help.



Literature – All our printed literature is available for free upon request for you or your clients.

## Industry Resources

Magnuson Group has partnered with some of the industry's best to ensure our products are easy to access, specify and purchase.



# Quick Ship in 5 Days or Less

## Bold is Fastest

A number of models and finishes of the products reflected on this page ship in 5 days or less. Please refer to the page referenced below for these specific products, models and finishes—identified in **bold print**—that qualify for Quick Ship. (Please refer to the Quick Ship Program Terms & Conditions.)

## Coat Racks

- Office Rak
- Rap Rak
- DS Series



DS SERIES



OFFICE RAK



RAP RAK

## Coat Trees

- MET
- PC Wall Series



STAINLESS STEEL SERIES



ALOES MET



PC WALL SERIES



7000 SERIES

## Hook Panels, Hook Strips, Hooks & Hangers

- Stainless Steel Series
- K Series Hooks
- Molded Polystyrene Hangers
- Steel Hangers



K-SERIES HOOKS



MOLDED POLYSTYRENE HANGERS



STEEL

## Magazine Racks/Chart Holders

- 7000 Series

## Freight is Quick and Easy

### Two Easy Options

There are two simple ways to price freight on your order:

#### 1. EZ Freight:

- Simply calculate 10% of the Total Order/List Price;
- Note "EZ Freight" on the PO. (Available in Continental US only; minimum order of \$200 List; standard delivery applies.) Truck minimum applies.

#### 2. Freight Quote:

- Simply call us at 1-800-342-5725 and we'll calculate your freight quote on the spot;
- Note "Freight Quote" on the PO

(Please refer to the EZ Freight Program Terms & Conditions, and an example of how to calculate using this method.)

www.filingtoday.com  
www.magnusongroup.com (Tel.) 800-342-5725 (Fax) 888-329-4729 1888-891-1970



# THE MAGNUSON GROUP ENVIRONMENTAL STATEMENT

## MANUFACTURING PRACTICES

### Manufacturing Process

The manufacturing process with Slope starts with partially recycled steel. The cold rolled carbon steel is formed and given a paint color with a low emitting powder coating.

All steel is sourced locally, within 95 miles of Magnuson Group's headquarters in Woodridge, IL, where final assembly occurs. Magnuson Group's vendors are carefully selected based on craftsmanship, location and environmental practices among other considerations

## MAINTENANCE & USE & DISPOSAL

### Cleaning

Slope can be cleaned using a damp cloth and mild non-abrasive cleaner.

### Ergonomic











Product is designed for ergonomic use, which will continue to service life.

### Recycling

At the end of its life cycle, Slope can be disassembled and recycled. The body is made primarily of steel, one of the most recycled materials on the planet, and the internal rigid liner is made of plastic, which is also easily recyclable. Receptacle is designed to maximize recycling rates through design, graphics, and signage placement.

## MAGNUSON GROUP GENERAL SUSTAINABILITY PRACTICES

Magnuson Group recognizes the importance of being good stewards to the earth. We incorporate positive environmental processes into all facets of the company. Whether the process is administrative in nature, or is in manufacturing, Magnuson Group strives to ensure that environmental concerns are made a part of the system. Some specifics include:

	Type	Description
	Steel	All steel scrap is 100% recycled. Steel is manufactured with 30-40% post consumer material and is 100% recyclable.
	Wood	Magnuson Group strives to always source wood from F.S.C. sources.
	Plastics	Plastics are 100% recyclable.
	Fabrics	Fabrics are manufactured from 100% post consumer materials, and is fire rated to: ASTM E-84 Class 1 or A.
	Aluminum	All aluminum scrap is 100% recycled. Aluminum comes from 10-20% post consumer material and is 100% recyclable.
	Packaging	Packaging comes from a minimum of 35% post consumer material and is 100% recyclable.
	Paints	All paints used are certified to be of low VOC content < 50g per liter. They emit no hazardous air pollutants (HAP) or noxious fumes when exposed to fire NFPA 704 Health = 1, Fire = 1, Reactivity = 0.
	Import	We import products from various countries in Europe. Most but not all are certified ISO 9001-14001 Environmental Management Systems. Please contact us if you need further information.
	Paper	All paper and packaging waste is 100% recycled.
	Plating	Plating is kept to the absolute minimum. Our plater's meet or exceed all Illinois EPA, Federal EPA, and OSHA mandated standards; all plating is RoHS compliant. Our plating emits no hazardous air pollutants (HAP) or noxious fumes when exposed to fire. We certify that there is no asbestos in any of the products we manufacture or import for sale.

# TERMS AND CONDITIONS - APRIL 1, 2023 - SPECIFICATIONS AND PRICE LIST

**Cash Terms:** Net 30 days. A service charge of 1% per month will be assessed on all past due accounts. Custom orders will require a deposit in advance.

First orders by new accounts will be on VISA, Master Card, Discover, American Express or check in advance. Open accounts may be established upon submission and approval of three trade references and bank information.

**Custom Orders:** All custom orders require a 50% non-refundable deposit of the total quoted price. The order will not be processed until the deposit is received.

**Non-Stock Orders:** All orders for items that are not in stock may require a 50% non-refundable deposit at time of order placement. The order will not be processed until the deposit is received.

**Large Orders:** Orders over \$10,000 net may require a 25% deposit at time of order placement.

**Mail, E-Mail and Fax Orders:** Mail, E-mail, and fax are the only acceptable methods of placing orders. If a confirming order is sent, it must be marked "CONFIRMING ORDER". Duplicate orders not marked "CONFIRMING ORDER" are the responsibility of the buyer.

**Order Acknowledgement:** Magnuson Group will confirm the buyers purchase order.

**Delays in Delivery:** Magnuson Group will not be held liable for failure to ship or deliver on or by any particular date.

**Freight Classification:** Classification can vary greatly based upon what and how much is ordered.

**Freight Terms:** F.O.B. Woodridge, Illinois. Freight charges are prepaid and added to invoice at time of shipment unless 3rd party billing is specified on the order.

**Quick Ship Program:** Items/colors in **bold print** ship in 5 working days. Quantity is limited to 10 units or less. Quickship items must be on separate P.O. form from standard lead time items.

**Title to Merchandise:** Once Magnuson Group delivers the product to the carrier, title to the merchandise and risk of loss passes to the buyer. We are not responsible for loss or damage during transit. All freight claims are the responsibility of the purchaser or consignee.

**Shipping Damage/Shortage Claims:** All shipments should be inspected carefully on delivery, and any apparent damage or shortages noted as exceptions on all copies of the delivery receipt. Notification of shortages or concealed damage must be made to the delivering carrier within 3 days of receipt.

Claims of either visible or concealed damage should be presented without delay to the carrier by the consignee.

**Shortage Claims:** Shortage claims reported 30 days beyond shipment date will not be honored.

**Routing:** UPS or Federal Express Ground will be used where size and weight restrictions allow. On larger shipments common carrier will be used.

**Order Changes:** Changes to orders in process are subject to approval and to the same conditions as cancellations.

**Cancellations and Returns:** Orders in any stage of processing and production may not be cancelled without authorization in writing from Magnuson Group and may be subject to a 50% cancellation fee. If a return is authorized, a minimum restocking charge of 30% will be incurred, return freight pre-paid. Returned goods must be unused and packaged in original cartons within 90 days of original shipping date. Custom orders cannot be returned. Credit will be issued subject to inspection by our receiving department.

**Price and Design Changes:** All prices are subject to change without notice and prices in effect at time of shipment will prevail. Magnuson Group reserves the right to improve product design, construction and quality without notice. EZ Freight program is subject to change without notice.

**Warranty:** All products and parts are warranted against defects in material and workmanship for the period of (2) years after shipment. Warranty is void if product is damaged through accident, improper use, abuse, or alteration.

**Limitation of Liability:** Magnuson Group's liability for any and all losses and damages to buyer resulting from any cause shall be limited only to the replacement or the repair of the product.

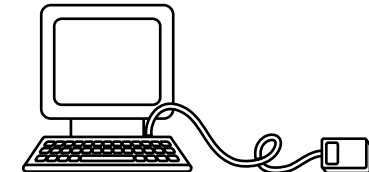

**For Your Convenience:** As an alternative to cash terms, we accept Visa, MasterCard, Discover and American Express.

**Save on Shipping Costs:** Many items in this line qualify for United Parcel Service routing.

**Visit us at our Web Site:** [www.magnusongroup.com](http://www.magnusongroup.com)

## E-Z FREIGHT PROGRAM

Magnuson Group now offers two options for calculating freight charges.

**Option One:** Calculate your freight charges using E-Z Freight as follows: Add 10% of the **total order list price** for all products to calculate the freight charge.

**Example:** 3 OR4A @ \$875.00 = \$2,625.00  
1 DS4H @ \$292.00 = \$292.00  
\$2,917.00  
**Total List:** \$2,917.00 x 10% = \$291.70  
Enter this amount on your order as E-Z Freight.

If E-Z Freight is not noted on your Purchase Order, actual freight will be charged. E-Z Freight applies to the 48 continental states only. Your order must be at least \$200 list to use this program.

**A minimum charge of \$195.00 for truck shipments applies.**

E-Z Freight calculations are for normal dock delivery only and do not include accessorial charges, such as "Call Before Delivery", "Inside Delivery", etc. which will be billed in addition to the E-Z Freight charges. Contact Customer Service for more information.

**Option Two:** Contact Customer Service at 800-342-5725 for a freight quote. Note the freight amount on your purchase order.  
[sales@filingtoday.com](mailto:sales@filingtoday.com)

[www.Filingtoday.com](http://www.Filingtoday.com)



**GSA**—We are a multiple contract holder with GSA. Please contact us for information.



UPS and UPS in shield design are registered trademarks of United Parcel Service of America, Inc. 1888-891-1976

# TABLE OF CONTENTS

[🕒 PRODUCT PRICING](#)
[🔗 WEB PAGE](#)
[📄 PRODUCT SPEC PDF](#)

BENCHES		
BODEN		
RESPIT		
BROCHURE & LEAFLET HOLDER		
DACAPO		
DACAPO I POINT		
COAT HANGERS		
BASIC		
FILO		
GRIP		
HANGER RECEPTACLES		
MIRAC		
MOLDED POLYSTYRENE HANGERS		
STEEL HANGERS		
TUBULUS		
UNIVERSUM		
COAT HOOK STRIPS		
ALOES MEW		
CLIMB		
K SERIES HOOK PANELS		
KOBE		
KROK BOX		
KROK HJH		
MIRAC		
NOMIS		
ONA		
SECOND TREE		
SEI		
SHERWOOD		
SLIDE W		
STAINLESS STEEL		
STAL		
STICKS HJH		
TERTIO H		
TERTIO HA		
TERTIO HD		
TERTIO HJH		
YIN MYIW		
COAT HOOKS		

BAMBU		
CANTHA		
K SERIES HOOKS		
KROK HJH-10		
MIRAC		
PC 550 SERIES		
PC SERIES PANEL/DOOR		
POINTO		
S SERIES		
S-SERIES ANTIMICROBIAL		
SHERWOOD		
STAL		
TERTIO H-K		
TREEHOOKED		
TUBULUS H		
YIN UNDER TABLE HOOK		
COAT HOOKS MAGNETIC		
K-50 MAGNETIC		
KOBE-MA		
KROK MAGNETIC		
MEM		
MYIM/MYIM JR		
NINO MAGNETIC		
OLEA-MA		
SHERWOOD		
TERTIO MAGNETIC		
COAT RACKS		
ARNAGE		
BUTLER		
DS SERIES		
DS SERIES WALL RACKS		
FRAME		
MEGA RAK		
OFFICE RAK		
RAP RAK		
TERTIO		
TERTIO W/K		
TERTIO W2		
COAT TREES		

ALOES MET		
BAMBU		
BRANCH		
HELIX		
HULOT		
KOBE		
MIRAC		
NANAME		
PALADINO		
SAGITTA		
SECOND TREE		
SHERWOOD		
SLIDE		
TAIGA		
YIN		
CROWD CONTROL		
STOPPER POINT		
TEMPALINE		
TREC		
DESK ACCESSORIES		
MADISON		
NEW PORT		
NEW PORT HIGH DESK MOUNT		
NEW PORT HIGH FREESTANDING		
NEW WAVE		
REST		
SUM		
SUP		
YOUME		
INFORMATION & GRAPHIC DISPLAY		
IFLAG		
SIGNCODE		
MAGAZINE RACKS		
COMPACT SOISTES		
CUBIC SOISTES		
FLAP		
IFLAG		
RACK SOISTES		
SCOOP		

USIO			
WALLMATE SOISTES			
ZIN			
<b>MESSAGE BOARD</b>			
PANTALLA			
<b>OCCASIONAL TABLES</b>			
CELES			
LAURA			
MILL			
OXI BISTROT			
<b>OUTDOOR ASHTRAYS</b>			
FUM			
RIGA			
VESUVIO			
<b>OUTDOOR SEATING</b>			
CALMA			
ISIDORA			
ISIDORO			
JOULE			
LUCIDO			
OM BASIC			
RIVISTA			
RIVISTA CHAIR			
STILLA			
VACANZA			
<b>OUTDOOR TABLES</b>			
CELES			
OXI BISTROT			
SIM			
STEP			
STILLA			
<b>OUTDOOR WASTE RECEPTACLES</b>			
BALLOON			
RE-SQUARE			

RETTO			
UMEA			
<b>PLANTERS</b>			
CIRKEL			
CONEE			
CREPE			
GREEN CLOUD			
GREEN LIGHT			
KASKAD			
LAURA			
PIC			
VALUTA			
<b>SANITIZATION &amp; PPE STATIONS</b>			
HAANDER			
ISBIT			
SOLNA FREESTANDING			
SOLNA WITH RECEPTACLE			
<b>SHELVING &amp; BOOKSHELVES</b>			
BALDAS			
KOKU			
OSSA			
USIO			
<b>SHOWCASES</b>			
PICTOR			
<b>SPACE DIVIDERS</b>			
KP+			
MADISON			
MALVA			
PARBAN			
<b>STOOLS</b>			
CALMA			
GINLET			
ISIDORO			
RIVISTA			

<b>UMBRELLA STANDS</b>			
DRIP			
DROP-IN			
FORREIN			
P70/P100			
PLATEA			
RIGA			
SOU			
YIN			
<b>WASTE RECEPTACLES</b>			
BALLOON			
CIRKEL			
DROP			
KASTA			
PIC			
PUP			
RE-SQUARE			
RETTO			
RIGA			
RUNDA			
SLOPE			
SLOPE JR.			
SORTMATE			
SOTARE			
STORLEK			
TRADA			
TROSA			
UMEA			
VALUTA			
VALUTA/SOTARE SIGNAGE			
<b>WORKSPACE &amp; COLLABORATIVE CARTS</b>			
HOLD			
HOLD DAILY			
STORE			

# WASTE RECEPTACLES

HOME → PRODUCTS → WASTE RECEPTACLES





# BALLOON

## BODY FINISH COLORS



Blue



Green



Grey



Red



White



Black



Yellow

## BASE FINISH COLOR

## LABEL OPTIONS



Cans



Cans & Bottles



Glass



Organics



Paper



Recycling



Waste

## FINISH COLORS



White Vinyl



Dark Grey Vinyl

All BALLOON units come with 1 standard label.  
BALLOON labels are a 4"x4" square.

## HOW TO ORDER



Select Model



Select Body Color





Select Label

Example Order: BAL-10; Body in Yellow; Paper Label

## ADDITIONAL NOTES

Ships via common carrier.



LINE ART	MODEL	H	W	D	WEIGHT	DESCRIPTION	COLOR/FINISH	LIST PRICE
	BAL-10	39 3/8"	15 3/8"	19 15/16"	29 lbs.	100% recyclable polythene body with base and internal container of recycled plastic. Waste front opening. Triangular snap lock. Body lifts off base to access internal container for easy emptying of trash. Rectangular base can be weighed down with pea gravel. One standard label included. Capacity 18.5 gallons.	Body in Green, Yellow, Blue, Red, Grey or White. Base in Black	1,035.00
	BAL-20	39 3/8"	15 3/8"	19 15/16"	29 lbs.	100% recyclable polythene body with base and internal container of recycled plastic. Circle front opening. Triangular snap lock. Body lifts off base to access internal container for easy emptying of trash. Rectangular base can be weighed down with pea gravel. One standard label included. Capacity 18.5 gallons.	Body in Green, Yellow, Blue, Red, Grey or White. Base in Black	1,035.00

# CIRKEL

## BODY FINISH COLORS



Black



Lunar White



Anodized Silver

## TOP/BASE FINISH COLORS



Black



Marine Blue



Sea Green



Lunar White



Anodized Silver

## TOP OPENING CHOICES



Counter Balance  
Swing Lid  
10 7/8" Diameter



Paper / Circle  
2"x12 3/16"  
5" Diameter

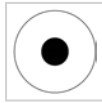

Small Circle  
5" Diameter

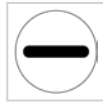

Paper  
2"x12 3/16"



Waste  
10 15/16" Diameter

## MULTI-LINGUAL LABEL OPTIONS



Glass



Landfill



Recycling (Arrows)



Organics

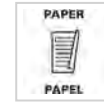

Paper



Compost



Waste



Recycling (Bottles  
& Cans)



Plastic



Cans

All CIRKEL units come with 1 standard label.  
CIRKEL Labels are 5" high, widths vary.

## MULTI-LINGUAL LABEL FINISH COLORS



White Vinyl



Black Vinyl



Dark Grey Vinyl



Vivid Blue Vinyl



Cactus Green Vinyl

## HOW TO ORDER



Select Model



Select Body Color



Select Top & Base  
Color



Select Top Opening  
(for CIRKEL-01/01L  
only)



Select Label &  
Color





Example Order: CIRKEL-01L; Body in Anodized Silver; Marine Blue Top & Base; Waste Top Opening; Organics Label in Vivid Blue

## ADDITIONAL NOTES

Ships via common carrier

Sample chips available.



LINE ART	MODEL	H	W	D	WEIGHT	DESCRIPTION	COLOR/FINISH	LIST PRICE
	CIRKEL-01	29 1/4"	15 1/4"	round	48 lbs.	Round waste receptacle with 19 gallon body and removable bag ring. Comes with choice of one removable top cut out opening. Includes one standard icon.	Body in Lunar White, Black Ral 9011 or Anodized Silver with base and lid available in Marine Blue, Sea Green, Lunar White, Black Ral 9011 or Anodized Silver.	995.00
	CIRKEL-01L	29 1/4"	15 1/4"	round	50 lbs.	Round waste receptacle with 19 gallon body, internal rigid liner and removable bag ring. Comes with choice of one removable top cut out opening. Includes one standard icon.	Body in Lunar White, Black Ral 9011 or Anodized Silver with base and lid available in Marine Blue, Sea Green, Lunar White, Black Ral 9011 or Anodized Silver.	1,135.00
	CIRKEL-03	29 1/4"	15 1/4"	round	53 lbs.	Round waste receptacle with 19 gallon body, removable bag ring and removable counterbalanced swing lid. Includes one standard icon.	Body in Lunar White, Black Ral 9011 or Anodized Silver with base and lid available in Marine Blue, Sea Green, Lunar White, Black Ral 9011 or Anodized Silver.	1,195.00
	CIRKEL-03L	29 1/4"	15 1/4"	round	55 lbs.	Round waste receptacle with 19 gallon body, internal rigid liner, removable bag ring and removable counterbalanced swing lid. Includes one standard icon.	Body in Lunar White, Black Ral 9011 or Anodized Silver with base and lid available in Marine Blue, Sea Green, Lunar White, Black Ral 9011 or Anodized Silver.	1,335.00
	CIRKEL-GLD					Set of 3 adjustable glides for CIRKEL base.		53.00

# DROP

## FINISH COLORS



Textured Black



Textured Forge Grey









Textured White



## ADDITIONAL NOTES

Ships via UPS

Sample chips available.

LINE ART	MODEL	H	W	D	WEIGHT	DESCRIPTION	COLOR/FINISH	LIST PRICE
	DROP-MINI	12"	8 7/8"	8 9/16"	5 lbs.	Textured painted steel waste bin with internal stainless bag ring. Capacity 3.4 gallons.	Textured White	360.00
	DROP-MINI-SO	12"	8 7/8"	8 9/16"	5 lbs.	Textured painted steel waste bin with internal stainless bag ring. Capacity 3.4 gallons.	Textured Black Ral 9011 or Textured Forge Grey	395.00
	DROP-10	14 11/16"	13 3/4"	8 11/16"	12 lbs.	Textured painted steel waste bin with internal stainless bag ring. Capacity 7.6 gallons.	Textured White	485.00
	DROP-10-SO	14 11/16"	13 3/4"	8 11/16"	12 lbs.	Textured painted steel waste bin with internal stainless bag ring. Capacity 7.6 gallons.	Textured Black RAL9011 or Textured Forge Grey	530.00
	DROP-20	18 7/8"	16 3/4"	7 1/16"	15 lbs.	Textured painted steel waste bin with internal stainless bag ring. Capacity 9.5 gallons.	Textured White	585.00
	DROP-20-SO	18 7/8"	16 3/4"	7 1/16"	15 lbs.	Textured painted steel waste bin with internal stainless bag ring. Capacity 9.5 gallons.	Textured Black RAL9011 or Textured Forge Grey	640.00



# KASTA

## BODY FINISH COLORS



Matte White RAL 9003



Matte Grey White RAL 9002



Matte Beige RAL 7032



Matte Grey RAL 7001

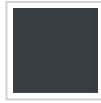

Matte Anthracite RAL 7016

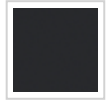

Matte Black RAL 9011

## TOP FINISH COLORS



Matte White RAL 9003



Matte Grey White RAL 9002



Matte Beige RAL 7032



Matte Grey RAL 7001



Matte Anthracite RAL 7016

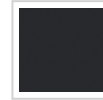

Matte Black RAL 9011



Matte Blue RAL 5009



Matte Green RAL 6011

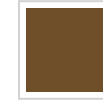

Matte Brown RAL 8002

## TOP OPENING CHOICES



45 Gal Waste 12" x 12"



45 Gal Recycling 4" x 12"



35 Gal Waste 8" x 12"



35 Gal Recycling 4" x 12"



30 Gal Waste 10" x 10"



30 Gal Recycling 4" x 10"



22 Gal Waste 6" x 10"



22 Gal Recycling 4" x 10"

## TEXT LABEL OPTIONS



Food Waste/Compost



Glass



Landfill



Paper



Plastic



Mixed Recycling



Metal

All KASTA units include 2 standard labels (text or icon labels). KASTA Text Labels are 5/8" high, widths vary.

## ICON LABEL OPTIONS



Food Waste/Compost



Glass



Landfill

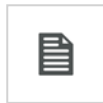

Paper



Plastic



Mixed Recycling



Metal

All KASTA units include 2 standard labels (text or icon labels). KASTA Icon label sizes vary and are approximately 2" high, widths vary.

## LABEL FINISH COLORS



Dark Grey Vinyl



White Vinyl

## LABEL PLACEMENT



45 Gallon Label Reference



35 Gallon Label Reference



30 Gallon Label Reference



22 Gallon Label Reference

## HOW TO ORDER



Select Model



Select Body Color



Select Top Color



Select Top Opening



Select Label(s), Placement and Color

Example Order: Model # KST-1818L; Matte Grey RAL 7001 Body; Matte Blue RAL 5009 Top; Waste Opening; Ref A: Mixed Recycling Text Label in White; Ref B: Mixed Recycling Icon Label in White.

## ADDITIONAL NOTES

Magnuson Group collaborated with Gensler, serving as product design consultant, for KASTA.

Ships via common carrier.



Each KASTA unit includes 2 standard labels (text or icon labels), if desired.



Use model GNG-MAG-2XL ganging magnets to gang KASTA units together. For each point of contact between adjacent units being ganged together, a quantity of 1x GNG-MAG-2XL is required. For example, ganging 3x KASTA units together would require a quantity of 2x GNG-MAG-2XL.

Place ganging magnets on the inside steel walls of each adjacent unit by removing the internal liners. Position the units together with magnets facing each other to create the greatest pull.

Sample chips available.



LINE ART	MODEL	H	W	D	WEIGHT	DESCRIPTION	COLOR/FINISH	LIST PRICE
	KST-1612L	28 1/4"	12"	16"	33 lbs.	Painted steel 22 gallon body rectangular waste receptacle with internal rigid liner, removable aluminum top, bag ring and adjustable glides.	Body in Matte White RAL 9003, Matte Grey White RAL 9002, Matte Beige RAL 7032, Matte Grey RAL 7001, Matte Anthracite RAL 7016 or Matte Black RAL 9011. Top in Matte White RAL 9003, Matte Grey White RAL 9002, Matte Beige RAL 7032, Matte Grey RAL 7001, Matte Anthracite RAL 7016, Matte Black RAL 9011, Matte Blue RAL 5009, Matte Green RAL 6011 or Matte Brown RAL 8002.	1,195.00
	KST-1616L	28 1/4"	16"	16"	39 lbs	Painted steel 30 gallon body square waste receptacle with internal rigid liner, removable aluminum top, bag ring and adjustable glides.	Body in Matte White RAL 9003, Matte Grey White RAL 9002, Matte Beige RAL 7032, Matte Grey RAL 7001, Matte Anthracite RAL 7016 or Matte Black RAL 9011. Top in Matte White RAL 9003, Matte Grey White RAL 9002, Matte Beige RAL 7032, Matte Grey RAL 7001, Matte Anthracite RAL 7016, Matte Black RAL 9011, Matte Blue RAL 5009, Matte Green RAL 6011 or Matte Brown RAL 8002.	1,295.00

	KST-1814L	33 1/4"	14"	18"	45 lbs.	Painted steel 35 gallon body rectangular waste receptacle with internal rigid liner, removable aluminum top, bag ring and adjustable glides.	Body in Matte White RAL 9003, Matte Grey White RAL 9002, Matte Beige RAL 7032, Matte Grey RAL 7001, Matte Anthracite RAL 7016 or Matte Black RAL 9011. Top in Matte White RAL 9003, Matte Grey White RAL 9002, Matte Beige RAL 7032, Matte Grey RAL 7001, Matte Anthracite RAL 7016, Matte Black RAL 9011, Matte Blue RAL 5009, Matte Green RAL 6011 or Matte Brown RAL 8002.	1,325.00
	KST-1818L	33 1/4"	18"	18"	52 lbs.	Painted steel 45 gallon body square waste receptacle with internal rigid liner, removable aluminum top, bag ring and adjustable glides.	Body in Matte White RAL 9003, Matte Grey White RAL 9002, Matte Beige RAL 7032, Matte Grey RAL 7001, Matte Anthracite RAL 7016 or Matte Black RAL 9011. Top in Matte White RAL 9003, Matte Grey White RAL 9002, Matte Beige RAL 7032, Matte Grey RAL 7001, Matte Anthracite RAL 7016, Matte Black RAL 9011, Matte Blue RAL 5009, Matte Green RAL 6011 or Matte Brown RAL 8002.	1,395.00
	GNG-MAG-2XL	12"	1 3/4"	5/8"	2 lbs.	Set of 2 magnets for ganging KASTA units together.		110.00

## BODY FINISH COLORS



Silver



White

## TOP FINISH COLORS



Silver



White



Chocolate



Blue



Green



Red



Yellow

## PIC-60 TOP OPENING CHOICES



PIC-60 Waste  
7 5/8" X 7 5/8"



PIC-60 Paper  
8 7/16" X 2 1/8"

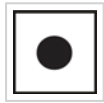

PIC-60 Circle  
4 1/4" Diameter

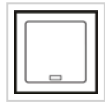

PIC-60 Swing Lid  
8 9/16" X 8 9/16"

## PIC-90R TOP OPENING CHOICES



PIC-90 Waste  
7 11/16" X 13 9/16"



PIC-90 Paper  
8 7/16" X 2 1/8"

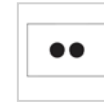

PIC-90 Circle  
4 1/4" Diameter

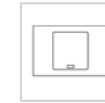

PIC-90 Swing Lid  
8 9/16" X 8 9/16"

## MULTI-LINGUAL LABEL OPTIONS



Cans



Compost



Glass



Recycling (Arrows)



Landfill



Organics



Paper



Plastic



Recycling (Bottles  
& Can)



Waste

## MULTI-LINGUAL LABEL FINISH COLORS



Traffic Grey Vinyl



White Vinyl

All PIC units come with 1 standard label per stream.  
PIC Labels are 5 1/2" high by 5 1/2" wide.

## HOW TO ORDER

#1

Select Model

#2

Select Body Color

#3

Select Top  
Opening(s) &  
Color(s)

#4

Select Label(s)

Example Order: PIC-2x60; White Body; Waste Left Opening in Silver, Paper Right Opening in Blue; Waste Label on Left, Paper Label on Right.







## ADDITIONAL NOTES

Ships via common carrier.

PIC units with White bodies have Grey labels & PIC units with Silver bodies have White labels.

Sample chips available.

LINE ART	MODEL	H	W	D	WEIGHT	DESCRIPTION	COLOR/FINISH	LIST PRICE
	PIC-60	26 15/16"	11 7/8"	11 7/8"	15 lbs.	Single compartment painted steel waste receptacle with 16 gallon body, internal bag ring and removable top. Includes one label.	White or Silver body, top in Blue, Green, Red, Yellow, Chocolate, White or Silver	945.00
	PIC-2x60	26 15/16"	23 5/8"	11 7/8"	31 lbs.	Double compartment painted steel waste receptacle with 32 gallon body, internal bag rings and removable tops (choose 2). Includes two labels.	White or Silver body, tops in Blue, Green, Red, Yellow, Chocolate, White or Silver	1,495.00
	PIC-3x60	26 15/16"	35 5/16"	11 7/8"	50 lbs.	Triple compartment painted steel waste receptacle with 48 gallon body, internal bag rings and removable tops (choose 3). Includes three labels.	White or Silver body, tops in Blue, Green, Red, Yellow, Chocolate, White or Silver	2,165.00
	PIC-90R	26 15/16"	17 11/16"	11 7/8"	22 lbs.	Single compartment painted steel waste receptacle with 24 gallon body, internal bag ring and removable top. Includes one label.	White or Silver body, top in Blue, Green, Red, Yellow, Chocolate, White or Silver	1,055.00
	PIC-2x90R	26 15/16"	35 5/16"	11 7/8"	50 lbs.	Double compartment painted steel waste receptacle with 48 gallon body, internal bag rings and removable tops (choose two). Includes two labels.	White or Silver body, tops in Blue, Green, Red, Yellow, Chocolate, White or Silver	2,115.00
	PIC-60-SWING					Square counterbalanced swing lid with magnetic soft close. For use with PIC-60, PIC-2x60 & PIC-3x60	Outside frame in White or Silver; Swing Lid in Blue, Green, Red, Yellow, Chocolate, Silver or White.	275.00
	PIC-90R-SWING					Rectangular counterbalanced swing lid with magnetic soft close. For use with PIC-90R & PIC-2x90R	Outside frame in White or Silver; Swing Lid in Blue, Green, Red, Yellow, Chocolate, Silver or White.	315.00



# PUP

## BODY FINISH COLORS



Silver



White

## TOP FINISH COLORS



Silver



White



Blue



Green



Yellow



Red

## HOW TO ORDER



Select Model



Select Body Color



Select Top Ring Color

Example Order: PUP with White Body and Blue Top Ring

## ADDITIONAL NOTES

Ships via UPS



LINE ART	MODEL	H	W	D	WEIGHT	DESCRIPTION	COLOR/FINISH	LIST PRICE
	PUP	13 7/8"	9 13/16"	9 13/16"	9 lbs.	Square metal waste basket with removable top ring that conceals the internal waste bag. Capacity 5.5 gallons.	White body with top ring in White, Blue, Green, Silver, Yellow or Red.	275.00
	PUP-SO	13 7/8"	9 13/16"	9 13/16"	9 lbs.	Square metal wastebasket with removable top ring that conceals the internal waste bag. Capacity 5.5 gallons.	Silver body with top ring in White, Blue, Green, Silver, Yellow or Red.	310.00

# RE-SQUARE

## TOP OPENING CHOICES



Square  
6 5/16" x 6 5/16"



Circle  
6 5/16" Diameter

## TOP LABEL OPTIONS

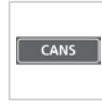

Cans



Compost



Glass



Landfill



Organics



Paper



Plastic



Recycling



Waste

RE-SQUARE Top Labels are 2 5/8" high by 9 7/8" wide.

## MULTI-LINGUAL LABEL OPTIONS



Cans



Compost



Glass



Landfill



Organics



Paper



Plastic



Recycling (Arrows)



Recycling (Bottles & Cans)



Waste

All RE-SQUARE units come with 1 standard label.  
RE-SQUARE Body Labels are 9" diameter in size.

## MULTI-LINGUAL LABEL COLORS



White

## HOW TO ORDER



Select Model



Select Top Insert  
Color



Select Label(s)

Example Order: RE-SQUARE-10; Top Insert in Blue; Cans Labels



## ADDITIONAL NOTES

Ships via common carrier

RE-SQUARE units come with White labels.

Sample chips available.



LINE ART	MODEL	H	W	D	WEIGHT	DESCRIPTION	COLOR/FINISH	LIST PRICE
	RE-SQUARE-10	39 1/4"	19"	20 3/8"	25 lbs.	Polyethylene body and top with square opening insert. Comes with hinged lid with bag holder. Can be ballasted to the ground with a sandbag if desired. Two labels included: one on top of lid and on front of body. Capacity 36 gallons.	Body and Top in Dark Grey. Top insert in Blue, White or Green.	825.00
	RE-SQUARE-11	39 1/4"	19"	20 3/8"	25 lbs.	Polyethylene body and top with circle opening insert. Comes with hinged lid with bag holder. Can be ballasted to the ground with a sandbag if desired. Two labels included: one on top of lid and on front of body. Capacity 36 gallons.	Body and Top in Dark Grey. Top insert in Blue, White or Green.	825.00
	RE-SQUARE-LOCK					Add-on lock compatible with all Re-Square models. Comes with one key.	Black	60.00

# RETTO

## LABEL OPTIONS



Cans



Cans & Bottles



Glass



Organics



Paper



Recycling



Waste

All RETTO units come with 1 standard label.  
RETTO labels are a 4"x4" square.

## FINISH COLORS



Textured Bronze

## MULTI-LINGUAL LABEL FINISH COLORS



White Vinyl

## HOW TO ORDER



Select Model



Select Label



Example Order: RETTO-01 with Glass Label

## ADDITIONAL NOTES

Ships via common carrier.

Sample chips available.



LINE ART	MODEL	H	W	D	WEIGHT	DESCRIPTION	COLOR/FINISH	LIST PRICE
	RETTO-01	43 13/16"	17 11/16"	18 7/8"	93 lbs.	Outdoor waste receptacle with front opening and galvanized liner. Locking front door with concealed hinges. Capacity 26.4 gallons. One standard label included.	Textured Bronze	1,575.00
	RETTO-02	43 13/16"	17 11/16"	18 7/8"	93 lbs.	Outdoor waste receptacle with front opening and galvanized liner. Includes rectangular stainless steel ashtray on lid. Locking front door with concealed hinges. Capacity 26.4 gallons. One standard label included.	Textured Bronze	1,975.00

# RIGA

## BODY FINISH COLORS



Stainless Steel RAL 9006

## TOP FINISH COLORS



Silver

## TOP OPENING OPTIONS



Riga 10/20  
4 11/16"Hx4 11/16"W

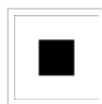

Riga 30/40  
6 7/8"Hx6 7/8"W

## HOW TO ORDER

#1

Select Model

#2

Select Top Color

Example Order: RIGA-20-P with Top in Blue RAL 5000





## ADDITIONAL NOTES

Riga-10 ships via UPS; Riga-20/30/40 ship via common carrier.

Riga Stainless Steel units are suitable for outdoor use under cover.

Sample chips available.



LINE ART	MODEL	H	W	D	WEIGHT	DESCRIPTION	COLOR/FINISH	LIST PRICE
	RIGA-10	19 5/16"	9 13/16"	9 13/16"	11 lbs.	Stainless steel waste receptacle with painted top and plastic base. Integrated bag ring. Top lifts out to change bag. Capacity 5.3 gallons.	Stainless Steel body with painted top in Silver RAL 9006.	905.00
	RIGA-20	27 15/16"	9 13/16"	9 13/16"	15 lbs.	Stainless steel waste receptacle with painted top and plastic base. Integrated bag ring. Top lifts out to change bag. Capacity 7.9 gallons.	Stainless Steel body with painted top in Silver RAL 9006.	1,150.00
	RIGA-30	28 3/4"	12 3/16"	12 3/16"	19 lbs.	Stainless steel waste receptacle with painted top. Integrated bag ring. Top lifts out to change bag. Capacity 13.2 gallons.	Stainless Steel body with painted top in Silver RAL 9006.	1,315.00
	RIGA-40	29 15/16"	13 3/4"	13 3/4"	22 lbs.	Stainless steel waste receptacle with painted top. Integrated bag ring. Top lifts out to change bag. Capacity 23.8 gallons.	Stainless Steel body with painted top in Silver RAL 9006.	1,485.00



# RUNDA

## FINISH COLORS



Textured Black



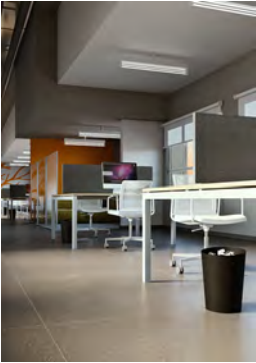

Textured White



## ADDITIONAL NOTES

Ships via UPS.

Sample chips available.

LINE ART	MODEL	H	W	D	WEIGHT	DESCRIPTION	COLOR/FINISH	LIST PRICE
	RUNDA	13"	10"	10"	7 lbs.	Round painted steel deskside receptacle with internal bag ring and angled top. 3.4 gallon capacity.	Textured Black Ral 9011 or Textured White 9010	225.00
	RUNDA-10+	13"	10"	10"	7 lbs.	Volume discount for an order of 10 or more RUNDA units. Round painted steel deskside receptacle with internal bag ring and angled top. 3.4 gallon capacity.	Textured Black Ral 9011 or Textured White 9010	205.00

# SLOPE

## BODY FINISH COLORS



Anodized Silver



Dark Anthracite



Lunar White

## TOP FINISH COLORS



Anodized Silver



Dark Anthracite



Lunar White



Capri Blue



Copper Brown



Fern Green

## TOP OPENING CHOICES



Waste  
8"Hx9"W



Paper  
2"Hx12"W



Recycling  
9"Hx4 1/4"W

## DOUBLE TOP OPENING CHOICES



Waste / Waste  
9 1/16"Hx5"W



Waste / Recycling  
9 1/16"Hx5"W  
9 1/16"Hx4 1/2"W



Waste / Paper  
9 1/16"Hx5"W  
9 1/16"Hx2"W



Recycling / Recycling  
9 1/16"Hx4 1/2"W  
9 1/16"Hx4 1/2"W



Recycling / Paper  
9 1/16"Hx4 1/2"W  
9 1/16"Hx2"W

## STANDARD ENGLISH LABEL OPTIONS



Waste



Paper



Recycling

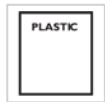

Plastic

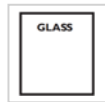

Glass



Organics



Cans



Compost



Landfill

## MULTI-LINGUAL LABEL OPTIONS



Cans



Compost



Glass



Landfill



Organics



Paper



Plastic



Recycling (Arrows)



Recycling (Bottles & Cans)



Waste

All SLOPE units come with 1 label per stream.  
SLOPE Labels are 1.2" high, widths vary.

SLOPE DOUBLE Labels are 1" high, widths vary.

All SLOPE units come with 1 label per stream.  
SLOPE Multi Lingual Labels are 4 5/8" diameter in size.

## MULTI-LINGUAL LABEL FINISH COLORS



Black Vinyl



Cactus Green Vinyl



Dark Grey Vinyl

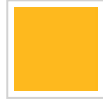

Sunflower Vinyl



Vivid Blue Vinyl



White Vinyl

## ADDITIONAL NOTES

Ships via common carrier

SLOPE units with White bodies have Dark Grey labels as a default & SLOPE units with Silver or Dark Anthracite bodies have White labels as a default.

Specify on order if Multi Lingual label is to be supplied in lieu of standard English label.

Single top opening units include one label, double top openings include two labels. Labels are placed on top of lid above top opening. Labels for double top units will be printed in slightly smaller font size in order to ensure fit.

Sample chips available.

## HOW TO ORDER



Select Model



Select Body Color



Select Top Color





Select Top Opening(s)



Select Label(s)

Example Order: Model # SLP-02L-DBL / #1 Dark Anthracite Body / #2 Capri Blue Top / #3 Recycling/Recycling Opening / #4 Cans label on left side, Plastic Label on right side.



LINE ART	MODEL	H	W	D	WEIGHT	DESCRIPTION	COLOR/FINISH	LIST PRICE
	SLP-01	38"	16 7/8"	18 1/8"	35 lbs	Painted steel waste receptacle with 38 gallon body, single top opening, integrated bag arms and non-skid glides.	Body in Anodized Silver, Dark Anthracite or Lunar White. Top in Anodized Silver, Dark Anthracite, Lunar White, Capri Blue, Copper Brown or Fern Green.	845.00
	SLP-01L	38"	16 7/8"	18 1/8"	43 lbs	Painted steel waste receptacle with 38 gallon body, internal rigid liner, single top opening, integrated bag arms and non-skid glides.	Body in Anodized Silver, Dark Anthracite or Lunar White. Top in Anodized Silver, Dark Anthracite, Lunar White, Capri Blue, Copper Brown or Fern Green.	895.00
	SLP-01L-DBL	38"	16 7/8"	18 1/8"	43 lbs	Painted steel waste receptacle with 38 gallon body, internal rigid liners, double top opening, integrated bag arms and non-skid glides.	Body in Anodized Silver, Dark Anthracite or Lunar White. Top in Anodized Silver, Dark Anthracite, Lunar White, Capri Blue, Copper Brown or Fern Green.	1,245.00
	SLP-GLD					Optional adjustable glides (must be ordered at same time as unit).	Black	72.00

# SLOPE JR.

## BODY FINISH COLORS



Anodized Silver



Dark Anthracite



Lunar White

## TOP FINISH COLORS



Anodized Silver



Dark Anthracite



Lunar White



Capri Blue



Copper Brown



Fern Green

## TOP OPENING CHOICES



Waste  
8"Hx9"W



Paper  
2"Hx12"W



Recycling  
9"Hx4 1/4"W

## DOUBLE TOP OPENING CHOICES



Waste / Waste  
9 1/16"Hx5"W



Waste / Recycling  
9 1/16"Hx5"W  
9 1/16"Hx4 1/2"W



Waste / Paper  
9 1/16"Hx5"W  
9 1/16"Hx2"W



Recycling / Recycling  
9 1/16"Hx4 1/2"W  
9 1/16"Hx4 1/2"W



Recycling / Paper  
9 1/16"Hx4 1/2"W  
9 1/16"Hx2"W

## STANDARD ENGLISH LABEL OPTIONS



Waste



Paper



Recycling

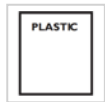

Plastic

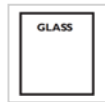

Glass



Organics



Cans



Compost



Landfill

## MULTI-LINGUAL LABEL OPTIONS



Cans



Compost



Glass



Landfill



Organics



Paper



Plastic



Recycling (Arrows)



Recycling (Bottles & Cans)



Waste

All SLOPE Jr. units come with 1 label per stream.  
SLOPE Labels are 1.2" high, widths vary.

SLOPE DOUBLE Labels are 1" high, widths vary.

All SLOPE Jr. units come with 1 label per stream.  
SLOPE Multi Lingual Labels are 4 5/8" diameter in size.

## MULTI-LINGUAL LABEL FINISH COLORS



Black Vinyl



Cactus Green Vinyl



Dark Grey Vinyl

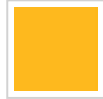

Sunflower Vinyl



Vivid Blue Vinyl



White Vinyl

## ADDITIONAL NOTES

Ships via common carrier

Specify on order if Multi Lingual Label is to be supplied in lieu of standard English label.

Single top opening units include one label, double top openings include two labels. Labels are placed on top of lid above top opening. Labels for double top units will be printed in slightly smaller font size in order to ensure fit.

Sample chips available.

## HOW TO ORDER



Select Model



Select Body Color



Select Top Color





Select Top Opening(s)



Select Label(s)

Example Order: Model # SLP-02L-DBL / #1 Dark Anthracite Body / #2 Capri Blue Top / #3 Recycling/Recycling Opening / #4 Cans label on left side, Plastic Label on right side.



LINE ART	MODEL	H	W	D	WEIGHT	DESCRIPTION	COLOR/FINISH	LIST PRICE
	SLP-02	32"	16 7/8"	18 1/8"	32 lbs.	Painted steel waste receptacle with 32 gallon body, single top opening, integrated bag arms and non-skid glides.	Body in Anodized Silver, Dark Anthracite or Lunar White. Top in Anodized Silver, Dark Anthracite, Lunar White, Capri Blue, Copper Brown or Fern Green.	755.00
	SLP-02L	32"	16 7/8"	18 1/8"	40 lbs.	Painted steel waste receptacle with 32 gallon body, internal rigid liner, single top opening, integrated bag arms and non-skid glides.	Body in Anodized Silver, Dark Anthracite or Lunar White. Top in Anodized Silver, Dark Anthracite, Lunar White, Capri Blue, Copper Brown or Fern Green.	855.00
	SLP-02L-DBL	32"	16 7/8"	18 1/8"	40 lbs	Painted steel waste receptacle with 32 gallon body, internal rigid liners, double top opening, integrated bag arms and non-skid glides.	Body in Anodized Silver, Dark Anthracite or Lunar White. Top in Anodized Silver, Dark Anthracite, Lunar White, Capri Blue, Copper Brown or Fern Green.	1,225.00
	SLP-GLD					Optional adjustable glides (must be ordered at same time as unit).	Black	72.00

# SORTMATE

## BODY FINISH COLORS



Silver



White



Black

## TOP FINISH COLORS



Silver



White



Black



Blue



Green



Red



Yellow

## HOW TO ORDER



Select Base Model (TR-10 or TR-50)



Select Optional Accompanying Hanging Side Models (TR-20 or TR-30)









Select Optional Corresponding Colored Lids (TR-40, TR-51 or TR-11)

## ADDITIONAL NOTES

Ships via UPS



LINE ART	MODEL	H	W	D	WEIGHT	DESCRIPTION	COLOR/FINISH	LIST PRICE
	TR-10-REC	13 3/8"	13 1/16"	9 5/8"	5 lbs.	6.9 gallon main bin	Recycled Black polypropylene	98.00
	TR-10-PP	13 3/8"	13 1/16"	9 5/8"	5 lbs.	6.9 gallon main bin	White or Silver polypropylene	135.00
	TR-20-REC	13 5/8"	9 5/16"	6 13/16"	3 lbs.	2.4 gallon large side bin	Recycled Black polypropylene	66.00
	TR-20-PP	13 5/8"	9 5/16"	6 13/16"	3 lbs.	2.4 gallon large side bin	White or Silver polypropylene	91.00
	TR-30-REC	7 3/16"	9 5/16"	6 13/16"	1 lb.	1.3 gallon small side bin	Recycled Black polypropylene	46.00

	TR-30-PP	7 3/16"	9 5/16"	6 13/16"	1 lb.	1.3 gallon small side bin	White or Silver polypropylene	60.00
	TR-40	N/A	9 5/16"	6 13/16"	1/4 lb.	Lid for TR20 and TR30	White, Black, Blue, Red, Green, Yellow or Silver	33.00
	TR-50-REC	13 5/8"	10 1/16"	10 3/16"	4 lbs.	4.75 gallon bin	Recycled Black polypropylene	72.00
	TR-50-PP	13 5/8"	10 1/16"	10 3/16"	4 lbs.	4.75 gallon bin	White or Silver polypropylene	138.00
	TR-51	N/A	6 3/8"	10"	1/2 lb.	Painted Steel Lid for TR-50	White, Silver, Black, Red, Green, Yellow, Blue	60.00
	TR-11	N/A	9 13/16"	10 7/8"	1 lb.	Painted Steel Lid for TR-10	White, Silver, Black, Red, Green, Yellow, Blue	56.00

# SOTARE

## BODY FINISH COLORS



Bronze Metallic



Anodized Silver



Dark Anthracite



Lunar White

## TOP FINISH COLORS



Bronze Metallic



Anodized Silver



Dark Anthracite



Lunar White

## HALF-ELLIPTICAL TOP OPENING CHOICES



Waste  
12-1/8"x11-3/4"



Circle  
4-1/4" diameter



Paper  
1-1/2"x11-3/4"



Circle / Circle  
4-1/4" diameter



Circle / Waste  
4-1/4" diameter  
4-3/8"x11-3/4"



Paper / Circle  
1-1/2"x11-3/4"  
4-1/4" diameter



Waste / Waste  
4-3/8"x11-3/4"



Paper / Waste  
1-1/2"x11-3/4"  
4-3/8"x11-3/4"

## QUARTER-ELLIPTICAL TOP OPENING CHOICES



Waste - Right  
4-3/8"x11-3/4"



Circle - Right  
4-1/4" diameter



Paper - Right  
1-1/2"x11-3/4"



Waste - Left  
4-3/8"x11-3/4"



Circle - Left  
4-1/4" diameter



Paper - Left  
1-1/2"x11-3/4"

## MULTI-LINGUAL LABEL OPTIONS



Cans



Compost



Glass



Landfill



Organics



Paper



Plastic



Recycling (Arrows)



Recycling (Bottles  
& Cans)



Waste

## MULTI-LINGUAL LABEL FINISH COLORS



Black Vinyl



Cactus Green Vinyl



Dark Grey Vinyl



Sunflower Vinyl



Vivid Blue Vinyl



White Vinyl

SOTARE SO1809L units come with 1 standard label  
SOTARE SO1818L units come with 2 standard labels.  
SOTARE Labels are 4 5/8" diameter in size.



## HOW TO ORDER

#1

#2

#3

#4

#5

Select Model

Select Body Color

Select Top Color





Select Top Opening

Select Label

Example Order: Model # SO1818L-DBL | #1 Anodized Silver Body | #2 Anodized Silver Top | #3 Circle-Waste Openings | #4 Cans & Waste Labels

Example Order: Model # SO1809L-LEFT | #1 Anodized Silver body | #2 Lunar White Top | #3 Paper Opening | #4 Paper label



LINE ART	MODEL	H	W	D	WEIGHT	DESCRIPTION	COLOR/FINISH	LIST PRICE
	SO1818L	33 3/4"	18"	18"	49 lbs.	Half elliptical shaped waste receptacle with 34 gallon body, internal rigid liner, removable wire bag ring and adjustable glides. Single top opening. Includes two standard labels.	Dark Anthracite, Anodized Silver, Lunar White, or Bronze Metallic	1,995.00
	SO1818L-DBL	33 3/4"	18"	18"	49 lbs.	Half elliptical shaped waste receptacle with 34 gallon body, internal rigid liner, removable wire bag ring and adjustable glides. Double top opening. Includes two standard labels.	Dark Anthracite, Anodized Silver, Lunar White, or Bronze Metallic	2,145.00
	SO1809L-LEFT	33 3/4"	9"	18"	37 lbs.	Left side quarter elliptical shaped waste receptacle with 14 gallon body, internal rigid liner, removable wire bag ring and adjustable glides. Includes one standard label.	Dark Anthracite, Anodized Silver, Lunar White, or Bronze Metallic	1,565.00
	SO1809L-RIGHT	33 3/4"	9"	18"	37 lbs.	Right side quarter elliptical shaped waste basket with 14 gallon body, internal rigid liner, removable wire bag ring and adjustable glides. Includes one standard label.	Dark Anthracite, Anodized Silver, Lunar White, or Bronze Metallic	1,565.00
	CST-WB				3 lbs.	Set of four casters for use with SO1818L models in place of standard adjustable glides. Adds 2 1/2" of height to each receptacle.	Black	90.00
	GNG-MAG-2	6"	1 1/2"	1/2"	2 lbs.	Set of 2 magnets for ganging Valuta or Sotare units together.		99.00

## ADDITIONAL NOTES

Ships via common carrier.

SOTARE half elliptical units receive two labels per unit. SOTARE quarter elliptical units receive one label per unit.

SOTARE units can also be configured with our Valuta family of receptacles.

Use magnets (model GNG-MAG-2; containing 2 magnets) to gang VALUTA/SOTARE units together. For each point of contact between adjacent units being ganged together, 2 magnets are required. For example, ganging 2 SOTARE units together would require 1 pair of ganging magnets.

Place ganging magnets on the inside steel walls of each adjacent unit by removing the internal liners. Position the units together with magnets facing each other to create the greatest pull.

Sample paint chips available.

# STORLEK

## BODY FINISH COLORS



Bronze Metallic



Anodized Silver



Dark Anthracite



Lunar White

## FRAME & TOP FINISH COLORS



Bronze Metallic



Anodized Silver



Dark Anthracite



Lunar White

## TOP OPENING CHOICES

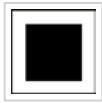

Waste  
14 3/4" Square



Paper  
2"Wx18"L

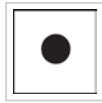

Circle  
8" Diameter

## MULTI-LINGUAL LABEL OPTIONS



Cans



Compost



Glass



Landfill



Organics



Paper



Plastic



Recycling (Arrows)



Recycling (Bottles & Cans)



Waste

All STORLEK units come with 1 standard label.  
STORLEK Labels are 9" diameter in size.

## MULTI-LINGUAL LABEL FINISH COLORS



Black Vinyl



Cactus Green Vinyl



Dark Grey Vinyl



Sunflower Vinyl



Vivid Blue Vinyl



White Vinyl

## LABEL PLACEMENT REFERENCE

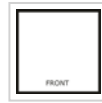

Ref. 1 - Front Door

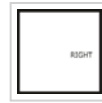

Ref. 2 - Right Side

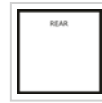

Ref. 3 - Rear

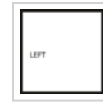

Ref. 4 - Left Side

## HOW TO ORDER

#1

Select Model

#2

Select Trim / Top Color

#3

Select Panel Colors

#4

Select Label

#5

Select Placement Choice

Example Order: ST-10 / Anodized Silver Frame & Top / Dark Anthracite Side Panels / Waste Label on Ref 1 Front Door







## ADDITIONAL NOTES

Ships via common carrier.

STORLEK comes with a lock and two keys. Facing the front of the unit, the lock is located on the right side and the hinge is on the left.

Substitute standard lock for a brass pull knob by adding model ST-KNOB to your purchase order.

Sample paint chips available.

LINE ART	MODEL	H	W	D	WEIGHT	DESCRIPTION	COLOR/FINISH	LIST PRICE
	ST-10	39 1/2"	23 7/8"	23 7/8"	94 lbs.	Painted steel waste receptacle with 70 gallon body, internal rigid liner, square waste top opening and front opening door with lock. One standard label included.	Panels in Dark Anthracite, Anodized Silver, Lunar White or Bronze Metallic. Frame, top & base in Dark Anthracite, Anodized Silver, Lunar White or Bronze Metallic.	2,445.00
	ST-11	39 1/2"	23 7/8"	23 7/8"	94 lbs.	Painted steel waste receptacle with 70 gallon body, internal rigid liner, circle recycling top opening and front opening door with lock. One standard label included.	Panels in Dark Anthracite, Anodized Silver, Lunar White or Bronze Metallic. Frame, top & base in Dark Anthracite, Anodized Silver, Lunar White or Bronze Metallic.	2,445.00
	ST-12	39 1/2"	23 7/8"	23 7/8"	94 lbs.	Painted steel waste receptacle with 70 gallon body, internal rigid liner, paper top opening and front opening door with lock. One standard label included.	Panels in Dark Anthracite, Anodized Silver, Lunar White or Bronze Metallic. Frame, top & base in Dark Anthracite, Anodized Silver, Lunar White or Bronze Metallic.	2,445.00
	ST-20	48"	23 7/8"	23 7/8"	106 lbs.	Painted steel waste receptacle with tray top, 70 gallon body, internal rigid liner, waste top opening and front opening door with lock. One standard label included. Tray top fits most standard food service trays.	Panels in Dark Anthracite, Anodized Silver, Lunar White or Bronze Metallic. Frame, top & base in Dark Anthracite, Anodized Silver, Lunar White or Bronze Metallic.	2,795.00
	ST-PNL-AD					One advertising display panel compatible on all STORLEK models. Used in lieu of standard panels and compatible on all 3 STORLEK sides except the door. For use to display posters and other advertising media (poster size of 17-7/8"W x 33-3/4"H, visible area of poster is 15-7/8"W x 31-1/4"H). MG recommends use of Sintra Rigid board up to 1/4" thickness.	Dark Anthracite, Anodized Silver, Lunar White or Bronze Metallic	295.00
	ST-KNOB	1 1/8"	1 1/8"	round	1/2 lb.	Cylindrical brass knob for use in place of standard lock on STORLEK front door. Quantity of 1. For use indoor only.	Satin Chrome, Black Chrome or Satin Nickel	90.00

# TRADA

## BODY FINISH COLORS



Britebond Silver



Mineral Bronze



Sky White

## TOP & STEP FINISH COLORS



Britebond Silver



Clementine Orange



Marigold Yellow



Marine Blue



Mineral Bronze



Sea Green



Sky White

## LABEL FINISH COLORS



Black Vinyl



Bright Orange Vinyl



Cactus Green Vinyl



Dark Grey Vinyl



Sunflower Vinyl



Vivid Blue Vinyl



White Vinyl

## ADDITIONAL NOTES

Ships via common carrier.

Sample chips available.

## TOP OPENING CHOICES



Waste  
14 1/4" x 8 1/4"



Paper  
2" x 14 1/4"



Circle  
4 1/4" Diameter

## MULTI-LINGUAL LABEL OPTIONS



Glass



Landfill



Recycling (Arrows)



Organics



Paper



Compost



Waste



Recycling (Bottles & Cans)



Plastic



Cans

All TRADA units come with 1 standard label.  
TRADA Labels are 5" high, widths vary.

## HOW TO ORDER



Select Model



Select Body Color



Select Top Opening  
(for TRADA-01  
only)





Select Top Color



Select Label &  
Color

Example Order: TRADA-01; Sky White Body; Waste Opening in Sea Green; Compost Label in Cactus Green



LINE ART	MODEL	H	W	D	WEIGHT	DESCRIPTION	COLOR/FINISH	LIST PRICE
	TRADA-01	30"	18 5/16"	12 1/4"	50 lbs.	Painted steel 24 gallon body waste receptacle with three top opening options, internal rigid liner and bag ring. adjustable glides. One standard label included. Liner capacity 16 gallons.	Body in Sky White, Britebond Silver or Mineral Bronze. Top in Sky White, Britebond Silver, Mineral Bronze, Sea Green, Marigold Yellow, Marine Blue or Clementine Orange.	1,360.00
	TRADA-STEP	30"	18 5/16"	14 1/4"	53 lbs.	Painted steel 24 gallon body waste receptacle with step mechanism with soft close, internal rigid liner and bag ring. Closed top, adjustable glides. One standard label included. Liner capacity 16 gallons. Top and step are painted the same color.	Body in Sky White, Britebond Silver or Mineral Bronze. Top in Sky White, Britebond Silver, Mineral Bronze, Sea Green, Marigold Yellow, Marine Blue or Clementine Orange.	1,725.00

## BODY FINISH COLORS



Textured White RAL 9003



Textured Beige RAL 7032



Textured Grey RAL 7001



Textured Anthracite RAL 7016

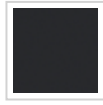

Textured Black RAL 9011

## TOP FINISH COLORS



Textured White RAL 9003



Textured Beige RAL 7032



Textured Grey RAL 7001



Textured Anthracite RAL 7016



Textured Black RAL 9011



Textured Blue RAL 5009



Textured Green RAL 6011

## TOP OPENING CHOICES



Waste  
11 1/2" x 11 1/2"



Recycling  
5" x 11 1/2"

## MULTI-LINGUAL LABEL OPTIONS



Cans



Compost



Glass



Landfill



Organics



Paper



Plastic



Recycling (Arrows)



Recycling (Bottles & Cans)



Waste

## MULTI-LINGUAL LABEL FINISH COLORS



Dark Grey Vinyl



White Vinyl

## HOW TO ORDER



Select Model



Select Body Color



Select Top Color



Select Top Opening



Select Label(s)

## ADDITIONAL NOTES



Ships via common carrier.

Use ganging kit model TRO-GNG containing pair of ganging brackets to join adjustable glides beneath adjacent units & spacer magnets placed in between units to gang TROSA units together. For each point of contact between adjacent units being ganged together, a quantity of 1 TRO-GNG is required. For example, ganging 3 TROSA units together would require a quantity of 2x TRO-GNG.

TRO-1818L-LOCK includes a locking front access door and one key. Facing the front of the unit, the lock is located on the right side of the door and the hinge is on the left side of the door.

Sample chips available.



LINE ART	MODEL	H	W	D	WEIGHT	DESCRIPTION	COLOR/FINISH	LIST PRICE
	TRO-1818L	40 1/4"	18"	18"	66 lbs.	Painted steel 42 gallon body waste receptacle with front access door, internal rigid liner and adjustable glides.	Body in Textured White RAL 9003, Textured Beige RAL 7032, Textured Grey RAL 7001, Textured Anthracite RAL 7016 or Textured Black RAL 9011. Top in Textured White RAL 9003, Textured Beige RAL 7032, Textured Grey RAL 7001, Textured Anthracite RAL 7016, Textured Black RAL 9011, Textured Blue RAL 5009 or Textured Green RAL 6011.	1,695.00
	TRO-1818L-LOCK	40 1/4"	18"	18"	67 lbs.	Painted steel 42 gallon body waste receptacle with locking front access door, internal rigid liner and adjustable glides.	Body in Textured White RAL 9003, Textured Beige RAL 7032, Textured Grey RAL 7001, Textured Anthracite RAL 7016 or Textured Black RAL 9011. Top in Textured White RAL 9003, Textured Beige RAL 7032, Textured Grey RAL 7001, Textured Anthracite RAL 7016, Textured Black RAL 9011, Textured Blue RAL 5009 or Textured Green RAL 6011. Lock in Black.	1,745.00
	TRO-GNG					Ganging kit includes pair of ganging brackets to join adjustable glides beneath adjacent units & spacer magnets placed in between units.	Ganging bracket in Textured Anthracite RAL 7016; Magnets in Black.	135.00
	CST-WB				3 lbs.	Set of four casters for use with TROSA models in place of standard adjustable glides. Adds 2 1/2" of height to each receptacle.	Black	90.00

## BODY FINISH COLORS



Sky White



Britebond Silver



Mineral Bronze

## SIDE PANEL/HOOD/TOP INSERT FINISH COLORS



Sea Green



Sky White



Britebond Silver



Mineral Bronze



Marigold Yellow



Marine Blue



Clementine Orange

## TOP OPENING CHOICES



Waste  
10 11/16" x 10 3/16"



Paper  
2" x 14"



Circle  
5" Diameter

## MULTI-LINGUAL LABEL OPTIONS



Waste



Paper

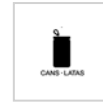

Cans



Landfill



Plastic



Glass



Organics



Recycling (Bottles  
& Cans)



Recycling (Arrows)



Compost

All UMEA units come with 1 standard label per stream.  
UMEA Labels are 4 3/4" high, widths vary.

## LABEL FINISH COLORS



Black Vinyl



Bright Orange Vinyl



Cactus Green Vinyl



Dark Grey Vinyl



Sunflower Vinyl



Vivid Blue Vinyl



White Vinyl



## OPTIONAL SIDE-PANEL CUTOUTS OR ADVERTISING PANEL



Waste



Recycling



Advertising Panel

## HOW TO ORDER



Select Model



Select Body Color



Select Top Opening(s) & Color(s)



Select Side Panel/Hood + Color(s)



Select Labels & Colors



Select Optional Side Panel Cutouts

Example Order: UMEA-21; Britebond Silver Body; Waste Left Opening in Marine Blue | Circle Right Opening in Clementine Orange; Sky White Side Panels & Hood; Waste Label on Left in Vivid Blue | Recycling Label on Right in Bright Orange; Waste Cutout on Side Panels

## ADDITIONAL NOTES

Ships via common carrier.









UMEA comes with a lock on each door and two keys. Facing the front of the unit, each lock is located on the right side of the door and the hinge is on the left side of the door.



Substitute standard lock for a brass pull knob by adding model UMEA-KNOB to your purchase order. Order one knob per lock needing replacement (i.e. for UMEA-30, order 3x). Recommended for indoor use only.

Sample chips available.



LINE ART	MODEL	H	W	D	WEIGHT	DESCRIPTION	COLOR/FINISH	LIST PRICE
	UMEA-10	35 1/2"	22"	18 1/2"	72 lbs.	Single 40 gallon body waste receptacle with internal rigid liner, locking front opening and painted side panels. One top opening.	Body colors in Sky White, Britebond Silver or Mineral Bronze. Side panels/hood/top insert colors in Sky White, Britebond Silver, Mineral Bronze, Sea Green, Marigold Yellow, Marine Blue or Clementine Orange.	2,595.00
	UMEA-11	44 3/4"	22"	18 1/2"	96 lbs.	Single 40 gallon body waste receptacle with flat hood, internal rigid liner, locking front opening and painted side panels. One top opening.	Body colors in Sky White, Britebond Silver or Mineral Bronze. Side panels/hood/top insert colors in Sky White, Britebond Silver, Mineral Bronze, Sea Green, Marigold Yellow, Marine Blue or Clementine Orange.	3,065.00
	UMEA-12	46 3/4"	22"	18 1/2"	101 lbs.	Single 40 gallon body waste receptacle with angled hood, internal rigid liner, locking front opening and painted side panels. One top opening.	Body colors in Sky White, Britebond Silver or Mineral Bronze. Side panels/hood/top insert colors in Sky White, Britebond Silver, Mineral Bronze, Sea Green, Marigold Yellow, Marine Blue or Clementine Orange.	3,195.00

	UMEA-20	35 1/2"	40"	18 1/2"	140 lbs.	Double 40 gallon body waste receptacle with internal rigid liner, locking front opening and painted side panels. Two top openings.	Body colors in Sky White, Britebond Silver or Mineral Bronze. Side panels/hood/top insert colors in Sky White, Britebond Silver, Mineral Bronze, Sea Green, Marigold Yellow, Marine Blue or Clementine Orange.	4,195.00
	UMEA-21	44 3/4"	40"	18 1/2"	164 lbs.	Double 40 gallon body waste receptacle with flat hood, internal rigid liner, locking front opening and painted side panels. Two top openings.	Body colors in Sky White, Britebond Silver or Mineral Bronze. Side panels/hood/top insert colors in Sky White, Britebond Silver, Mineral Bronze, Sea Green, Marigold Yellow, Marine Blue or Clementine Orange.	4,845.00
	UMEA-22	46 3/4"	40"	18 1/2"	169 lbs.	Double 40 gallon body waste receptacle with angled hood, internal rigid liner, locking front opening and painted side panels. Two top openings.	Body colors in Sky White, Britebond Silver or Mineral Bronze. Side panels/hood/top insert colors in Sky White, Britebond Silver, Mineral Bronze, Sea Green, Marigold Yellow, Marine Blue or Clementine Orange.	5,045.00
	UMEA-30	35 1/2"	58"	18 1/2"	203 lbs.	Triple 40 gallon body waste receptacle with internal rigid liner, locking front opening and painted side panels. Three top openings.	Body colors in Sky White, Britebond Silver or Mineral Bronze. Side panels/hood/top insert colors in Sky White, Britebond Silver, Mineral Bronze, Sea Green, Marigold Yellow, Marine Blue or Clementine Orange.	5,965.00
	UMEA-31	44 3/4"	58"	18 1/2"	227 lbs.	Triple 40 gallon body waste receptacle with flat hood, internal rigid liner, locking front opening and painted side panels. Three top openings.	Body colors in Sky White, Britebond Silver or Mineral Bronze. Side panels/hood/top insert colors in Sky White, Britebond Silver, Mineral Bronze, Sea Green, Marigold Yellow, Marine Blue or Clementine Orange.	6,745.00
	UMEA-32	46 3/4"	58"	18 1/2"	232 lbs.	Triple 40 gallon body waste receptacle with angled hood, internal rigid liner, locking front opening and painted side panels. Three top openings.	Body colors in Sky White, Britebond Silver or Mineral Bronze. Side panels/hood/top insert colors in Sky White, Britebond Silver, Mineral Bronze, Sea Green, Marigold Yellow, Marine Blue or Clementine Orange.	6,795.00
	UMEA-PNL-ARROWS					Pair of painted steel side panel with laser cut recycling arrows cutout, in place of standard side panels.	Sky White, Britebond Silver, Mineral Bronze, Sea Green, Marigold Yellow, Marine Blue or Clementine Orange.	295.00
	UMEA-PNL-WASTE					Pair of painted steel side panel with laser cut waste cutout, in place of standard side panels.	Sky White, Britebond Silver, Mineral Bronze, Sea Green, Marigold Yellow, Marine Blue or Clementine Orange.	295.00

	UMEA-PNL-AD					Pair of advertising display side panels, in place of standard side panels. For use with Sintra Rigid Board - poster is easily interchangeable. Advertising panels have the ability to be retrofitted to existing units. MG recommends Sintra Rigid Board for both indoor and outdoor environments. Poster should be 34 7/16"H x 15 1/4" W and 1/16" thick.	Sky White, Britebond Silver, Mineral Bronze, Sea Green, Marigold Yellow, Marine Blue or Clementine Orange.	350.00
	UMEA-KNOB	1 1/8"	1 1/8"	round	1/2 lb.	Cylindrical brass knob for use in place of standard lock on UMEA front door. Quantity of 1. For use indoor only.	Satin Chrome, Black Chrome or Satin Nickel	90.00

# VALUTA

## BODY FINISH COLORS



Bronze Metallic



Anodized Silver



Dark Anthracite



Lunar White

## TOP FINISH COLORS



Bronze Metallic



Anodized Silver



Dark Anthracite



Lunar White

## TOP OPENING CHOICES



20 Gal - Waste  
4-1/4"x13-3/16"



20 Gal - Paper  
2"x12"

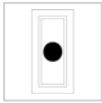

20 Gal - Circle  
4-1/4" Diameter

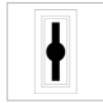

20 Gal - Paper/Circle  
2"x12"  
4-1/4" Diameter

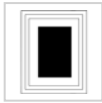

32 Gal - Waste  
7-1/8"x11"



32 Gal - Paper  
2"x11"

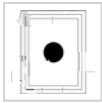

32 Gal - Circle  
4-1/4" Diameter

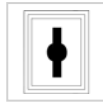

32 Gal - Paper/Circle  
2"x11"  
4-1/4" Diameter



40 Gal - Waste  
11-1/16" x 11-1/16"



40 Gal - Paper  
2"x15-5/8"

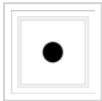

40 Gal - Circle  
4-1/4" Diameter



40 Gal - Paper/Circle  
2"x15-5/8"  
4-1/4" Diameter



35 Gal - Waste  
11-1/16"x11-1/16"



35 Gal - Paper  
2"x15-5/8"



35 Gal - Circle  
4-1/4" Diameter



35 Gal - Paper/Circle  
2"x15-5/8"  
4-1/4" Diameter

## MULTI-LINGUAL LABEL OPTIONS



Cans



Compost



Glass



Landfill



Organics



Paper



Plastic



Recycling (Arrows)



Recycling (Bottles & Cans)



Waste

All VALUTA units come with 1 standard label.  
VALUTA Labels are 4 5/8" diameter in size.

## MULTI-LINGUAL LABEL FINISH COLORS



Black Vinyl



Cactus Green Vinyl



Dark Grey Vinyl



Sunflower Vinyl



Vivid Blue Vinyl



White Vinyl

## LABEL PLACEMENT



40 Gallon Label Reference



20 Gallon Label Reference



35 Gallon Label Reference

## HOW TO ORDER



Select Model



Select Body Color



Select Top Color



Select Top Opening



Select Label & Color



Select Placement Choice

Example Order: Model # VA1818L; Dark Anthracite Body; Anodized Silver Top; Waste Opening; Waste Label/Reference 1

## ADDITIONAL NOTES

Ships via common carrier.

Use magnets (model GNG-MAG-2; containing 2 magnets) to gang VALUTA/SOTARE units together. For each point of contact between adjacent units being ganged together, 2 magnets are required. For example, ganging 3 VALUTA units together would require 2 pairs of ganging magnets.

Place ganging magnets on the inside steel walls of each adjacent unit by removing the internal liners. Position the units together with magnets facing each other to create the greatest pull.





VALUTA units can also be configured with our SOTARE family of receptacles.

VALUTA Secure models have a narrower 1/2" wide paper opening with a locking lid for secure document disposal.

Sample chips available.



LINE ART	MODEL	H	W	D	WEIGHT	DESCRIPTION	COLOR/FINISH	LIST PRICE
	VA1809L-JR	26 1/8"	9"	18"	30 lbs.	Junior height painted steel 14 gallon body waste receptacle with internal rigid liner, integrated bag arms and adjustable glides.	Dark Anthracite, Anodized Silver, Lunar White, Bronze Metallic	940.00
	VA1809L	33 3/4"	9"	18"	34 lbs.	Painted steel 20 gallon body waste receptacle with internal rigid liner, integrated bag arms and adjustable glides.	Dark Anthracite, Anodized Silver, Lunar White, Bronze Metallic	995.00
	VA1814L	33 3/4"	14"	18"	47 lbs.	Painted steel 32 gallon body waste receptacle with internal rigid liner, integrated bag arms and adjustable glides.	Dark Anthracite, Anodized Silver, Lunar White, Bronze Metallic	1,095.00
	VA1818L	33 3/4"	18"	18"	54 lbs.	Painted steel 40 gallon body waste receptacle with internal rigid liner, integrated bag arms and adjustable glides.	Dark Anthracite, Anodized Silver, Lunar White, Bronze Metallic	1,195.00

	VA18SCL	33 3/4"	18"	18"	50 lbs.	Painted steel 35 gallon body waste receptacle with internal rigid liner, integrated bag arms and adjustable glides.	Dark Anthracite, Anodized Silver, Lunar White, Bronze Metallic	1,295.00
	VA1809L-SEC	33 3/4"	9"	18"	34 lbs.	Painted steel 20 gallon body waste receptacle with internal rigid liner, integrated bag arms, adjustable glides and locking top with 1/2" wide opening for secure document disposal.	Anodized Silver top only. Body in Anodized Silver or Dark Anthracite	1,120.00
	VA1814L-SEC	33 3/4"	14"	18"	48 lbs.	Painted steel 32 gallon body waste receptacle with internal rigid liner, integrated bag arms, adjustable glides and locking top with 1/2" wide slot for secure document disposal.	Anodized Silver top only. Body in Anodized Silver or Dark Anthracite	1,280.00
	VA1818L-SEC	33 3/4"	18"	18"	54 lbs.	Painted steel 40 gallon body waste receptacle with internal rigid liner, integrated bag arms, adjustable glides and locking top with 1/2" wide opening for secure document disposal.	Anodized Silver top only. Body in Anodized Silver or Dark Anthracite	1,385.00
	CST-WB				3 lbs.	Set of four casters for use with VA1818L & VA1814L models in place of standard adjustable glides. Adds 2 1/2" of height to each receptacle.	Black	90.00
	GNG-MAG-2	6"	1 1/2"	1/2"	2 lbs.	Set of 2 magnets for ganging Valuta or Sotare units together.		99.00

# VALUTA/SOTARE SIGNAGE

## SIGNAGE GRAPHICS



Cans



Compost



Glass



Landfill



Organics



Paper



Plastic



Recycling



Waste

VALUTA/SOTARE SIGNAGE Magnetic Graphics are 12" high by 8" wide.

## HOW TO ORDER



Select Model



Select Signage Graphic



Select Signage Graphic Finish Color

1. Select either the signage holder with MG magnetic graphics (SIGN-MAG) or signage holder with acrylic front and customer provided graphics (SIGN-ACR.)
2. If MG magnetic graphic option (SIGN-MAG) is specified:
  - a. Select an MG magnetic graphic\*\*
  - b. Select color—Vivid Blue, Cactus Green, Sunflower or Black
  - c. Select removeable (magnetic; SIGN-MAG-R) or permanent (secured using spray adhesive; SIGN-MAG-P) graphic attachment.
3. If using with Valuta, indicate the desired placement of the signage holder using Valuta Label Reference Placement images. The signage holder should be placed opposite the vinyl icon (i.e. Vinyl Icon Ref 1; Signage Holder Ref 3.) See Valuta family for placement diagram.
4. If using Sotare, signage holder position is already determined.

\*\*Graphic options can be modified for an upcharge. Contact customer service for details.

Example Orders of Valuta units with Signage Holder:

- VA1818L; Dark Anthracite Body, Anodized Silver Top; Waste Opening; Waste Icon, Ref 1 + SIGN-ACR in Dark Anthracite; Ref 3
- VA1809L; Bronze Metallic Body, Bronze Metallic Top; Paper Opening; Paper Icon, Ref 4 + SIGN-MAG-P in Bronze Metallic with Sunflower Paper Graphic; Ref 2

Example Orders of Sotare units with Signage Holder:

- SO1818L; Lunar White Body, Lunar White Top; Waste Opening; Landfill Icon + SIGN-MAG-P in Lunar White with Black Landfill Graphic
- SO1809L-RIGHT; Dark Anthracite Body, Dark Anthracite Top; Waste Opening; Compost Icon + SIGN-ACR in Dark Anthracite

## SIGNAGE GRAPHIC FINISH COLORS



Black Foil



Cactus Green Foil



Sunflower Foil



Vivid Blue Foil



## ADDITIONAL NOTES

Ships via common carrier.

Valuta/Sotare Sign Holder is made of painted steel and is secured to the back of Valuta/Sotare receptacles. There are two unique offerings:

1. Painted Steel Sign Holder with MG Magnetic Graphics (SIGN-MAG-R/P)—The 8" x 12" graphic is applied directly to the painted steel sign holder, leaving no painted steel exposed. Each unique graphic is available in 4 finishes. This graphic can be either removeable (magnetic) or permanent (adhesive backing).
2. Painted Steel Sign Holder with Acrylic Front and Customer Created Graphic Insert (SIGN-ACR)—A removeable acrylic cover allows for the use of custom signage using 8 1/2" x 11" sized media (or smaller.) This flexible option provides the ability for customer designed & produced signage.



LINE ART	MODEL	H	W	D	WEIGHT	DESCRIPTION	COLOR/FINISH	LIST PRICE
	SIGN-ACR	22"	8" 3/4"	1/8"	4 lbs.	Painted steel signage holder with acrylic front to hold customer supplied printed graphics. Sign holder attaches to back of Valuta/Sotare receptacles.	Anodized Silver, Dark Anthracite, Lunar White or Bronze Metallic	150.00
	SIGN-MAG-R	22"	8" 3/4"	1/8"	4 lbs.	Painted steel signage holder with a removable printed magnet graphic. Sign holder attaches to back of Valuta/Sotare receptacles.	Anodized Silver, Dark Anthracite, Lunar White or Bronze Metallic	165.00
	SIGN-MAG-P	22"	8" 3/4"	1/8"	4 lbs.	Painted steel signage holder with a permanent printed graphic. Sign holder attaches to back of Valuta/Sotare receptacles.	Anodized Silver, Dark Anthracite, Lunar White or Bronze Metallic	165.00



# OUTDOOR WASTE RECEPTACLES

---

HOME → PRODUCTS → OUTDOOR WASTE RECEPTACLES



# BALLOON

## BODY FINISH COLORS



Blue



Green



Grey



Red



White



Black



Yellow

## BASE FINISH COLOR

## LABEL OPTIONS



Cans



Cans & Bottles



Glass



Organics



Paper



Recycling



Waste

## FINISH COLORS



White Vinyl



Dark Grey Vinyl

All BALLOON units come with 1 standard label.  
BALLOON labels are a 4"x4" square.

## HOW TO ORDER



Select Model



Select Body Color





Select Label

Example Order: BAL-10; Body in Yellow; Paper Label

## ADDITIONAL NOTES

Ships via common carrier.



LINE ART	MODEL	H	W	D	WEIGHT	DESCRIPTION	COLOR/FINISH	LIST PRICE
	BAL-10	39 3/8"	15 3/8"	19 15/16"	29 lbs.	100% recyclable polythene body with base and internal container of recycled plastic. Waste front opening. Triangular snap lock. Body lifts off base to access internal container for easy emptying of trash. Rectangular base can be weighed down with pea gravel. One standard label included. Capacity 18.5 gallons.	Body in Green, Yellow, Blue, Red, Grey or White. Base in Black	1,035.00
	BAL-20	39 3/8"	15 3/8"	19 15/16"	29 lbs.	100% recyclable polythene body with base and internal container of recycled plastic. Circle front opening. Triangular snap lock. Body lifts off base to access internal container for easy emptying of trash. Rectangular base can be weighed down with pea gravel. One standard label included. Capacity 18.5 gallons.	Body in Green, Yellow, Blue, Red, Grey or White. Base in Black	1,035.00

# RE-SQUARE

## TOP OPENING CHOICES



Square  
6 5/16" x 6 5/16"



Circle  
6 5/16" Diameter

## TOP LABEL OPTIONS



Cans



Compost



Glass



Landfill



Organics



Paper



Plastic



Recycling



Waste

RE-SQUARE Top Labels are 2 5/8" high by 9 7/8" wide.

## MULTI-LINGUAL LABEL OPTIONS



Cans



Compost



Glass



Landfill



Organics



Paper



Plastic



Recycling (Arrows)



Recycling (Bottles  
& Cans)



Waste

All RE-SQUARE units come with 1 standard label.  
RE-SQUARE Body Labels are 9" diameter in size.

## MULTI-LINGUAL LABEL COLORS



White

## HOW TO ORDER



Select Model



Select Top Insert  
Color



Select Label(s)

Example Order: RE-SQUARE-10; Top Insert in Blue; Cans Labels



## ADDITIONAL NOTES

Ships via common carrier

RE-SQUARE units come with White labels.

Sample chips available.



LINE ART	MODEL	H	W	D	WEIGHT	DESCRIPTION	COLOR/FINISH	LIST PRICE
	RE-SQUARE-10	39 1/4"	19"	20 3/8"	25 lbs.	Polyethylene body and top with square opening insert. Comes with hinged lid with bag holder. Can be ballasted to the ground with a sandbag if desired. Two labels included: one on top of lid and on front of body. Capacity 36 gallons.	Body and Top in Dark Grey. Top insert in Blue, White or Green.	825.00
	RE-SQUARE-11	39 1/4"	19"	20 3/8"	25 lbs.	Polyethylene body and top with circle opening insert. Comes with hinged lid with bag holder. Can be ballasted to the ground with a sandbag if desired. Two labels included: one on top of lid and on front of body. Capacity 36 gallons.	Body and Top in Dark Grey. Top insert in Blue, White or Green.	825.00
	RE-SQUARE-LOCK					Add-on lock compatible with all Re-Square models. Comes with one key.	Black	60.00

# RETTO

## LABEL OPTIONS



Cans



Cans & Bottles



Glass



Organics



Paper



Recycling



Waste

All RETTO units come with 1 standard label.  
RETTO labels are a 4"x4" square.

## FINISH COLORS



Textured Bronze

## MULTI-LINGUAL LABEL FINISH COLORS



White Vinyl

## HOW TO ORDER



Select Model



Select Label



Example Order: RETTO-01 with Glass Label

## ADDITIONAL NOTES

Ships via common carrier.

Sample chips available.



LINE ART	MODEL	H	W	D	WEIGHT	DESCRIPTION	COLOR/FINISH	LIST PRICE
	RETTO-01	43 13/16"	17 11/16"	18 7/8"	93 lbs.	Outdoor waste receptacle with front opening and galvanized liner. Locking front door with concealed hinges. Capacity 26.4 gallons. One standard label included.	Textured Bronze	1,575.00
	RETTO-02	43 13/16"	17 11/16"	18 7/8"	93 lbs.	Outdoor waste receptacle with front opening and galvanized liner. Includes rectangular stainless steel ashtray on lid. Locking front door with concealed hinges. Capacity 26.4 gallons. One standard label included.	Textured Bronze	1,975.00

## BODY FINISH COLORS



Sky White



Britebond Silver



Mineral Bronze

## SIDE PANEL/HOOD/TOP INSERT FINISH COLORS



Sea Green



Sky White



Britebond Silver



Mineral Bronze



Marigold Yellow



Marine Blue



Clementine Orange

## TOP OPENING CHOICES



Waste  
10 11/16" x 10 3/16"



Paper  
2" x 14"



Circle  
5" Diameter

## MULTI-LINGUAL LABEL OPTIONS



Waste



Paper

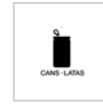

Cans



Landfill



Plastic



Glass



Organics



Recycling (Bottles  
& Cans)



Recycling (Arrows)



Compost

All UMEA units come with 1 standard label per stream.  
UMEA Labels are 4 3/4" high, widths vary.

## LABEL FINISH COLORS



Black Vinyl



Bright Orange Vinyl



Cactus Green Vinyl



Dark Grey Vinyl



Sunflower Vinyl



Vivid Blue Vinyl



White Vinyl

## OPTIONAL SIDE-PANEL CUTOUTS OR ADVERTISING PANEL



Waste



Recycling



Advertising Panel

## HOW TO ORDER



Select Model



Select Body Color



Select Top Opening(s) & Color(s)



Select Side Panel/Hood + Color(s)



Select Labels & Colors



Select Optional Side Panel Cutouts

Example Order: UMEA-21; Britebond Silver Body; Waste Left Opening in Marine Blue | Circle Right Opening in Clementine Orange; Sky White Side Panels & Hood; Waste Label on Left in Vivid Blue | Recycling Label on Right in Bright Orange; Waste Cutout on Side Panels

## ADDITIONAL NOTES

Ships via common carrier.

UMEA comes with a lock on each door and two keys. Facing the front of the unit, each lock is located on the right side of the door and the hinge is on the left side of the door.









Substitute standard lock for a brass pull knob by adding model UMEA-KNOB to your purchase order. Order one knob per lock needing replacement (i.e. for UMEA-30, order 3x). Recommended for indoor use only.



Sample chips available.



LINE ART	MODEL	H	W	D	WEIGHT	DESCRIPTION	COLOR/FINISH	LIST PRICE
	UMEA-10	35 1/2"	22"	18 1/2"	72 lbs.	Single 40 gallon body waste receptacle with internal rigid liner, locking front opening and painted side panels. One top opening.	Body colors in Sky White, Britebond Silver or Mineral Bronze. Side panels/hood/top insert colors in Sky White, Britebond Silver, Mineral Bronze, Sea Green, Marigold Yellow, Marine Blue or Clementine Orange.	2,595.00
	UMEA-11	44 3/4"	22"	18 1/2"	96 lbs.	Single 40 gallon body waste receptacle with flat hood, internal rigid liner, locking front opening and painted side panels. One top opening.	Body colors in Sky White, Britebond Silver or Mineral Bronze. Side panels/hood/top insert colors in Sky White, Britebond Silver, Mineral Bronze, Sea Green, Marigold Yellow, Marine Blue or Clementine Orange.	3,065.00
	UMEA-12	46 3/4"	22"	18 1/2"	101 lbs.	Single 40 gallon body waste receptacle with angled hood, internal rigid liner, locking front opening and painted side panels. One top opening.	Body colors in Sky White, Britebond Silver or Mineral Bronze. Side panels/hood/top insert colors in Sky White, Britebond Silver, Mineral Bronze, Sea Green, Marigold Yellow, Marine Blue or Clementine Orange.	3,195.00



	UMEA-20	35 1/2"	40"	18 1/2"	140 lbs.	Double 40 gallon body waste receptacle with internal rigid liner, locking front opening and painted side panels. Two top openings.	Body colors in Sky White, Britebond Silver or Mineral Bronze. Side panels/hood/top insert colors in Sky White, Britebond Silver, Mineral Bronze, Sea Green, Marigold Yellow, Marine Blue or Clementine Orange.	4,195.00
	UMEA-21	44 3/4"	40"	18 1/2"	164 lbs.	Double 40 gallon body waste receptacle with flat hood, internal rigid liner, locking front opening and painted side panels. Two top openings.	Body colors in Sky White, Britebond Silver or Mineral Bronze. Side panels/hood/top insert colors in Sky White, Britebond Silver, Mineral Bronze, Sea Green, Marigold Yellow, Marine Blue or Clementine Orange.	4,845.00
	UMEA-22	46 3/4"	40"	18 1/2"	169 lbs.	Double 40 gallon body waste receptacle with angled hood, internal rigid liner, locking front opening and painted side panels. Two top openings.	Body colors in Sky White, Britebond Silver or Mineral Bronze. Side panels/hood/top insert colors in Sky White, Britebond Silver, Mineral Bronze, Sea Green, Marigold Yellow, Marine Blue or Clementine Orange.	5,045.00
	UMEA-30	35 1/2"	58"	18 1/2"	203 lbs.	Triple 40 gallon body waste receptacle with internal rigid liner, locking front opening and painted side panels. Three top openings.	Body colors in Sky White, Britebond Silver or Mineral Bronze. Side panels/hood/top insert colors in Sky White, Britebond Silver, Mineral Bronze, Sea Green, Marigold Yellow, Marine Blue or Clementine Orange.	5,965.00
	UMEA-31	44 3/4"	58"	18 1/2"	227 lbs.	Triple 40 gallon body waste receptacle with flat hood, internal rigid liner, locking front opening and painted side panels. Three top openings.	Body colors in Sky White, Britebond Silver or Mineral Bronze. Side panels/hood/top insert colors in Sky White, Britebond Silver, Mineral Bronze, Sea Green, Marigold Yellow, Marine Blue or Clementine Orange.	6,745.00
	UMEA-32	46 3/4"	58"	18 1/2"	232 lbs.	Triple 40 gallon body waste receptacle with angled hood, internal rigid liner, locking front opening and painted side panels. Three top openings.	Body colors in Sky White, Britebond Silver or Mineral Bronze. Side panels/hood/top insert colors in Sky White, Britebond Silver, Mineral Bronze, Sea Green, Marigold Yellow, Marine Blue or Clementine Orange.	6,795.00
	UMEA-PNL-ARROWS					Pair of painted steel side panel with laser cut recycling arrows cutout, in place of standard side panels.	Sky White, Britebond Silver, Mineral Bronze, Sea Green, Marigold Yellow, Marine Blue or Clementine Orange.	295.00
	UMEA-PNL-WASTE					Pair of painted steel side panel with laser cut waste cutout, in place of standard side panels.	Sky White, Britebond Silver, Mineral Bronze, Sea Green, Marigold Yellow, Marine Blue or Clementine Orange.	295.00

	UMEA-PNL-AD					Pair of advertising display side panels, in place of standard side panels. For use with Sintra Rigid Board - poster is easily interchangeable. Advertising panels have the ability to be retrofitted to existing units. MG recommends Sintra Rigid Board for both indoor and outdoor environments. Poster should be 34 7/16"H x 15 1/4" W and 1/16" thick.	Sky White, Britebond Silver, Mineral Bronze, Sea Green, Marigold Yellow, Marine Blue or Clementine Orange.	350.00
	UMEA-KNOB	1 1/8"	1 1/8"	round	1/2 lb.	Cylindrical brass knob for use in place of standard lock on UMEA front door. Quantity of 1. For use indoor only.	Satin Chrome, Black Chrome or Satin Nickel	90.00

# PLANTERS

HOME → PRODUCTS → PLANTERS

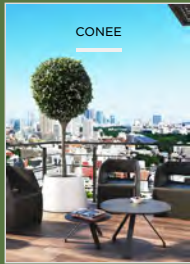

# CIRKEL

## FINISH COLORS



Black



Lunar White



Anodized Silver

## PLANTER TOP



Planter  
12 3/4" Diameter

## ADDITIONAL NOTES

Ships via common carrier.



LINE ART	MODEL	H	W	D	WEIGHT	DESCRIPTION	COLOR/FINISH	LIST PRICE
	CIRKEL-P	29 1/4"	15 1/4"	round	48 lbs.	Indoor round planter with integrated rigid plastic liner and removable top ring. Planter opening is 12 1/2" wide and 12" deep.	Body in Lunar White, Black Ral 9011 or Anodized Silver; Base and Lid in Lunar White, Black Ral 9011 or Anodized Silver.	1,165.00
	CIRKEL-GLD					Set of 3 adjustable glides for CIRKEL base.		53.00

# CONEE

## FINISH COLORS



Textured Black



Textured Forge Grey





Textured White

## ADDITIONAL NOTES

Ships via common carrier.

Sample chips available.



LINE ART	MODEL	H	W	D	WEIGHT	DESCRIPTION	COLOR/FINISH	LIST PRICE
	CON-SPL-EXT	11 7/16"	15"	round	11 lbs.	Outdoor painted aluminum planter on casters with drip tray and flowerpot.	Textured Black Ral 9011, Textured White or Textured Forge Grey	1,545.00
	CON-MPL-EXT	19 11/16"	31 1/2"	round	27 lbs.	Outdoor painted aluminum planter on casters with drip tray and flowerpot.	Textured Black Ral 9011, Textured White or Textured Forge Grey	3,145.00

# CREPE

## FINISH COLORS



Textured Black



Textured Forge Grey



Matte White



## ADDITIONAL NOTES

Crepe-S ships via UPS; Crepe-L/H ship via common carrier.

Sample chips available.

LINE ART	MODEL	H	W	D	WEIGHT	DESCRIPTION	COLOR/FINISH	LIST PRICE
	CREPE-S	16 1/8"	18 1/8"	15 3/4"	15 lbs.	Outdoor/Indoor aluminum square planter with plastic water saucer and flower pot.	Textured Forge Grey, Textured Black Ral 9011 or Matte White Ral 9003	1,765.00
	CREPE-L	16 1/8"	48 3/4"	15 3/4"	31 lbs.	Outdoor/Indoor aluminum rectangular planter with three plastic water saucers and three flower pots.	Textured Forge Grey, Textured Black Ral 9011 or Matte White RAL 9003	2,995.00
	CREPE-H	47 5/8"	18 1/8"	15 3/4"	42 lbs.	Outdoor/Indoor aluminum planter with plastic water saucer and flower pot.	Textured Forge Grey, Textured Black Ral 9011 or Matte White Ral 9003	2,995.00

# GREEN CLOUD

## FINISH COLORS



White



Black

## ADDITIONAL NOTES

Hanging Green Cloud units ("H") ship via UPS; Freestanding Green Cloud units ("S") ship via common carrier.

GL-40-S-H triangular hanging wire extends 15 3/4" above the planter; total height of planter & triangular wire is 24 15/16".

GL-50-M-H triangular hanging wire extends 18 1/2" above the planter; total height of planter & triangular wire is 27 11/16".

GL-60-L-H triangular hanging wire extends 21 5/8" above the planter; total height of planter & triangular wire is 30 7/8".

The ceiling chain (above the triangular hanging wire) is 56 1/2" long, and can be cut to desired height.

Sample chips available.



LINE ART	MODEL	H	W	D	WEIGHT	DESCRIPTION	COLOR/FINISH	LIST PRICE
	GL-10-S-S	26 1/4"	14 15/16"	round	27 lbs.	Round standing flower pot in painted steel and aluminum. Includes molded water saucer and three round flower pots	Matte White Ral 9003 or Satin Black Ral 9011	1,895.00
	GL-20-M-S	44 7/8"	17 5/16"	round	37 lbs.	Round standing flower pot in painted steel and aluminum. Includes molded water saucer and four round flower pots.	Matte White Ral 9003 or Satin Black Ral 9011	2,445.00
	GL-30-L-S	59 1/16"	20 1/4"	round	48 lbs.	Round standing flower pot in painted steel and aluminum. Includes molded water saucer and five round flower pots.	Matte White Ral 9003 or Satin Black Ral 9011	2,595.00
	GL-40-S-H	9 1/4"	14 15/16"	round	10 lbs.	Round hanging flower pot in painted steel and aluminum. Includes molded water saucer and three round flower pots. Triangular hanging wire is 15 3/4" and ceiling mounted wire is up to 56 1/2". Hanging wires included.	Matte White Ral 9003 or Satin Black Ral 9011	1,895.00
	GL-50-M-H	9 1/4"	17 5/16"	round	12 lbs.	Round hanging flower pot in painted steel and aluminum. Includes molded water saucer and four round flower pots. Triangular hanging wire is 18 1/2" and ceiling mounted wire is up to 56 1/2". Hanging wires included.	Matte White Ral 9003 or Satin Black Ral 9011	1,995.00
	GL-60-L-H	9 1/4"	20 1/4"	round	14 lbs.	Round hanging flower pot in painted steel and aluminum. Includes molded water saucer and five round flower pots. Triangular hanging wire is 21 5/8" and ceiling mounted wire is up to 56 1/2". Hanging wires included.	Matte White Ral 9003 or Satin Black Ral 9011	2,345.00

# GREEN LIGHT

## FINISH COLORS



Matte White



Black

## ADDITIONAL NOTES

Ships via UPS.

GREENLIGHT-C includes two triangular hanging steel wires which are 15 3/4" long. The ceiling chain extends up to 56 1/2".

GREENLIGHT includes a plastic internal liner (6 1/8" H x 19 3/8" W x 7" D) with a drip tray that snaps to the bottom of the liner. Plants must be housed in small pots within internal liner.

Sample chips available.



LINE ART	MODEL	H	W	D	WEIGHT	DESCRIPTION	COLOR/FINISH	LIST PRICE
	GREENLIGHT-C	6 3/4"	19 3/4"	7 1/2"	6 lbs.	Indoor rectangular aluminum hanging planter with steel base. Includes plastic molded water saucer and internal liner. Triangular hanging steel wires are 15 3/4" long/ceiling chain up to 56 1/2". Two hanging steel wires included.	Matte White RAL 9003 or Satin Black RAL 9011	975.00
	GREENLIGHT-T	9 1/2"	19 3/4"	7 1/2"	6 lbs.	Indoor rectangular aluminum freestanding planter with steel base. Includes plastic molded water saucer and internal liner.	Matte White RAL 9003 or Satin Black RAL 9011	975.00
	GREENLIGHT-P	6 3/4"	19 3/4"	8"	6 lbs.	Indoor rectangular aluminum wall mounted planter with steel base. Includes painted steel wall mounted shelf, plastic molded water saucer and internal liner.	Matte White RAL 9003 or Satin Black RAL 9011	995.00



# KASKAD

## FINISH COLORS



Textured White



Textured Silver

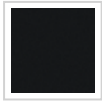

Textured Black



Textured Bronze

## ADDITIONAL NOTES

Ships via common carrier.

All 20" tall ("M" models) and 36" tall ("H" models) Kaskad planters include 14 1/2" x 26 1/2" polybag(s) that can be filled with pea gravel to add ballast as required, depending on the specific situation [i.e., when using dense/tall plant material, where the units are situated, etc.]. Each polybag, if filled to 50% full with pea gravel, will add approximately 25 pounds of weight to the base. If additional stability is required, floor anchors can be provided upon request for no charge (hardware not included).

All 36" high Kaskad units are shipped to you completely assembled with adjustable glides in place on the base. Also included in the carton are two stabilizer bases that can be used in place of the adjustable glides for additional stability when the units are placed in open areas.





Kaskad's fully enclosed watertight internal liner is 7 3/4" deep and can be removed if it is not being used to contain the plants.

KAS-0936 units and KAS-1836 units utilize two separate internal liners for plants.

Sample chips available.



LINE ART	MODEL	H	W	D	WEIGHT	DESCRIPTION	COLOR/FINISH	LIST PRICE
	KAS-0918S	12"	18"	9"	18 lbs.	Indoor painted steel rectangular planter with liner and adjustable glides	Textured Bronze, Textured White RAL 9010, Textured Silver or Textured Black	625.00
	KAS-0918M	20"	18"	9"	24 lbs.	Indoor painted steel rectangular planter with liner and adjustable glides	Textured Bronze, Textured White RAL 9010, Textured Silver or Textured Black	795.00
	KAS-0918H	36"	18"	9"	36 lbs.	Indoor painted steel rectangular planter with liner, adjustable glides and two stabilizer bases that can be used in place of adjustable glides for additional stability	Textured Bronze, Textured White RAL 9010, Textured Silver or Textured Black	995.00
	KAS-0936S	12"	36"	9"	32 lbs.	Indoor painted steel rectangular planter with two liners and adjustable glides	Textured Bronze, Textured White RAL 9010, Textured Silver or Textured Black	1,075.00
	KAS-0936M	20"	36"	9"	41 lbs.	Indoor painted steel rectangular planter with two liners and adjustable glides	Textured Bronze, Textured White RAL 9010, Textured Silver or Textured Black	1,235.00
	KAS-0936H	36"	36"	9"	59 lbs.	Indoor painted steel rectangular planter with two liners, adjustable glides and two stabilizer bases that can be used in place of adjustable glides for additional stability	Textured Bronze, Textured White RAL 9010, Textured Silver or Textured Black	1,475.00
	KAS-1818S	12"	18"	18"	28 lbs.	Indoor painted steel square planter with liner and adjustable glides	Textured Bronze, Textured White RAL 9010, Textured Silver or Textured Black	810.00

	KAS-1818M	20"	18"	18"	34 lbs.	Indoor painted steel square planter with liner and adjustable glides	Textured Bronze, Textured White RAL 9010, Textured Silver or Textured Black	1,035.00
	KAS-1836S	12"	36"	18"	49 lbs	Indoor painted steel rectangular planter with two liners and adjustable glides	Textured Bronze, Textured White RAL 9010, Textured Silver or Textured Black	1,335.00
	KAS-1836M	20"	36"	18"	59 lbs.	Indoor painted steel rectangular planter with two liners and adjustable glides	Textured Bronze, Textured White RAL 9010, Textured Silver or Textured Black	1,585.00
	KAS-PS	12"	13"	28 1/2"	26 lbs.	Indoor painted steel parallelogram shaped planter with liner and adjustable glides	Textured Bronze, Textured White RAL 9010, Textured Silver or Textured Black	895.00
	KAS-PM	20"	13"	28 1/2"	38 lbs	Indoor painted steel parallelogram shaped planter with liner and adjustable glides	Textured Bronze, Textured White RAL 9010, Textured Silver or Textured Black	1,125.00

## LAURA

### FINISH COLORS



White

### ADDITIONAL NOTES

Ships via UPS

Sample chips available.



LINE ART	MODEL	H	W	D	WEIGHT	DESCRIPTION	COLOR/FINISH	LIST PRICE
	LAURA	19 3/4"	27 5/8"	round	36 lbs.	Round table with planter or storage space in base. Planter area is 9 1/2" high x15 3/4" round. Indoor only.	Matte White Ral 9003	2,625.00

## BODY FINISH COLORS



Silver



White

## TOP FINISH COLORS



Silver



White

## ADDITIONAL NOTES

Ships via common carrier.





PIC planter can be used with or without a lid, depending on the fit of the plants.

Each square and rectangular lid comes in 2 parts, split in half diagonally. This allows for easy lid removal with minimal handling or moving of the plant.

Each planter compartment has an internal liner for plants that is 9 7/16" deep. The PIC-60 plant liner measures 9 7/16" x 9 7/16" at the top and 4 15/16" x 4 15/16" at the bottom. The PIC-90R plant liner measures 15 3/8" x 9 7/16" at the top and 10 13/16" x 4 15/16" at the bottom.

Sample chips available.



LINE ART	MODEL	H	W	D	WEIGHT	DESCRIPTION	COLOR/FINISH	LIST PRICE
	PIC-60-P	26 15/16"	11 7/8"	11 7/8"	15 lbs.	Indoor single compartment painted steel square planter with internal liner and removable top.	White or Silver Body & White or Silver Top	1,055.00
	PIC-2x60-P	26 15/16"	23 5/8"	11 7/8"	31 lbs.	Indoor double compartment painted steel planter with two internal liners and removable tops.	White or Silver Body & White or Silver Top	1,595.00
	PIC-3x60-P	26 15/16"	35 5/16"	11 7/8"	50 lbs.	Indoor triple compartment painted steel planter with three internal liners and removable tops.	White or Silver Body & White or Silver Top	2,415.00
	PIC-90R-P	26 15/16"	17 11/16"	11 7/8"	22 lbs.	Indoor single compartment painted steel rectangular planter with internal liner and removable top.	White or Silver Body & White or Silver Top	1,170.00
	PIC-2x90R-P	26 15/16"	35 5/16"	11 7/8"	50 lbs.	Indoor double compartment painted steel rectangular planter with two internal liners and removable tops.	White or Silver Body & White or Silver Top	2,365.00

# VALUTA

## BODY FINISH COLORS



Bronze Metallic



Anodized Silver



Dark Anthracite



Lunar White

## TOP FINISH COLORS



Bronze Metallic



Anodized Silver



Dark Anthracite



Lunar White

## TOP OPENINGS



VA1809L-P  
1809L-JR-P  
4-1/4"x13-3/16"



VA1814L  
8-1/4"x12-3/4"



VA1818L  
12-3/4"x12-3/4"

## HOW TO ORDER



Select Model



Select Body Color



Select Top Color

## ADDITIONAL NOTES

Ships via common carrier.

VALUTA Planter's fully enclosed watertight internal liner depths are as follows: VA1809L-JR: 6"; VA1809L: 6"; VA1814L: 8" VA1818L: 12".



Use magnets (model GNG-MAG-2; containing 2 magnets) to gang VALUTA/SOTARE units together. For each point of contact between adjacent units being ganged together, 2 magnets are required. For example, ganging 3 VALUTA units together would require 2 pairs of ganging magnets.

Place ganging magnets on the inside steel walls of each adjacent unit by removing the internal liners. Position the units together with magnets facing each other to create the greatest pull.

VALUTA units can also be configured with our SOTARE family of receptacles.

Sample chips available.



LINE ART	MODEL	H	W	D	WEIGHT	DESCRIPTION	COLOR/FINISH	LIST PRICE
	VA1809L-JR-P	26 1/8"	9"	18"	27 lbs.	Indoor junior height painted steel rectangular planter with internal rigid liner and adjustable glides.	Dark Anthracite, Anodized Silver, Lunar White, Bronze Metallic	940.00
	VA1809L-P	33 3/4"	9"	18"	30 lbs.	Indoor painted steel rectangular planter with internal rigid liner and adjustable glides.	Dark Anthracite, Anodized Silver, Lunar White, Bronze Metallic	995.00
	VA1814L-P	33 3/4"	14"	18"	42 lbs.	Indoor painted steel rectangular planter with internal rigid liner and adjustable glides.	Dark Anthracite, Anodized Silver, Lunar White, Bronze Metallic	1,095.00



---

VA1818L-P	33 3/4"	18"	18"	46 lbs.	Indoor painted steel square planter with internal rigid liner and adjustable glides.	Dark Anthracite, Anodized Silver, Lunar White, Bronze Metallic	1,195.00
CST-WB				3 lbs.	Set of four casters for use with VA1818L-P & VA1814L-P models in place of standard adjustable glides. Adds 2 1/2" of height to each receptacle.	Black	90.00
GNG-MAG-2	6"	1 1/2"	1/2"	2 lbs.	Set of 2 magnets for ganging Valuta or Sotare units together.		99.00

---

# BENCHES

---

[HOME](#) → [PRODUCTS](#) → [BENCHES](#)



# BODEN

## FINISH COLOR



Polished White



Polished Grey

## ADDITIONAL NOTES

Ships via common carrier on an oversized pallet (72" L x 48" W x H: 24.75" H). Forklift required for receipt of common carrier delivery. Deliveries requiring more than a standard tailgate delivery available for additional charge, contact Customer Service for details. If you know you will be unable to unload the shipment from the truck, you must order "Lift Gate Service" for an additional charge. It is your responsibility to move the shipment from the delivery point. Redelivery charges will apply if you are unable to unload the shipment when it arrives.

BODEN utilizes a glass fiber reinforced concrete mixture with additional internal structural reinforcement. Concrete is a natural material, expect some naturally occurring color variation.

BODEN weight capacity is 875 lbs.





BOD-B-MOUNT mounting plate is sold in pairs and used to secure BODEN to the ground. A mounting plate is secured to each side of the bench using epoxy. Use bolts appropriate for the surface application to secure the mounting plate to the ground (bolts/screws not included).

BOD-B-SKATE skate stops are sold per unit and require assembly: drilling two holes per skate stop and securing with epoxy, which is included.

Custom colors available (model BOD-B-01CM) for an upcharge with a minimum order quantity of 5 benches, contact Customer Service for details.

Sample chips available.



LINE ART	MODEL	H	W	D	WEIGHT	DESCRIPTION	COLOR/FINISH	LIST PRICE
	BOD-B-01	16 1/2"	61 1/2"	17 3/4"	185 lbs.	Outdoor/Indoor high performance cast concrete bench	White Polished Concrete or Grey Polished Concrete	3,645.00
	BOD-B-01CM	16 1/2"	61 1/2"	17 3/4"	185 lbs.	Custom color outdoor/indoor high performance cast concrete bench. Minimum order quantity 5.	Custom	3,995.00
	BOD-B-SKATE	3/4"	1"	3 1/2"	2 lbs.	Single aluminum skate stop for use on BODEN bench. Assembly required, includes epoxy.	Clear Anodized Aluminum	125.00
	BOD-B-MOUNT	1/8"	9"	3 7/8"	1 lb.	Pair of mounting plates for use with BODEN Bench. Assembly required, includes epoxy.	Stainless Steel	150.00

# RESPIT

## FINISH COLORS



White Ral 9016



Copper Brown Ral 8004



Moss Grey Ral 7003

## CUSHION FINISHES



Siltech Grain 6300-2



Siltech Grain 6300-22



Siltech Grain 6300-26



Siltech Press 6298-113



Siltech Press 6298-114



Siltech Press 6298-135



Siltech Press 6298-138



Siltech Press 6298-141



Siltech Press 6298-159



Siltech Press 6298-164

## ADDITIONAL NOTES

Ships via common carrier.

RESPIT meets or exceeds the minimum requirements per ANSI/BIFMA X5.4-2012 lounge and public seating standard.



RESPIT can be bolted to the floor (hardware not included). Comes with non-skid polyurethane on bench legs to grip the floor surface and prevent sliding.

Cushion on RESPIT-01C is polyurethane foam - 47 3/8" wide x 17 7/16" deep x 1" high. Cushion is easily removeable for cleaning, secured to the bench using velcro strips.

COM subject to approval, contact Customer Service for details.

Sample chips available.



LINE ART	MODEL	H	W	D	WEIGHT	DESCRIPTION	COLOR/FINISH	LIST PRICE
	RESPIT-01	16 1/2"	62 1/4"	18"	60 lbs.	Painted steel bench for indoor environments.	Seat and frame in White RAL 9016 or seat in Moss Grey RAL 7003 with frame in Copper Brown RAL 8004	2,175.00
	RESPIT-01C	16 7/8"	62 1/4"	18"	63 lbs.	Painted steel bench with cushion for indoor environments.	Seat and frame in White RAL 9016 or seat in Moss Grey RAL 7003 with frame in Copper Brown RAL 8004. Cushion available in any Carnegie Siltech Press 6298 or Carnegie Siltech Grain 6300 upholstery.	2,895.00



# WORKSPACE & COLLABORATIVE CARTS

---

HOME → PRODUCTS → WORKSPACE & COLLABORATIVE CARTS

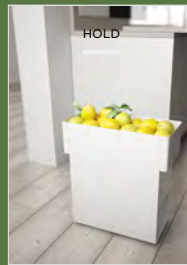

# HOLD

## FINISH COLORS



Textured Black



Textured Forge Grey









Textured White

## ADDITIONAL NOTES

Ships via common carrier.

Sample chips available.



LINE ART	MODEL	H	W	D	WEIGHT	DESCRIPTION	COLOR/FINISH	LIST PRICE
	HOLD	20 7/8"	8 5/8"	19"	25 lbs.	Painted steel utility cart with one fixed shelf and methacrylate top.	Textured White, Textured Black Ral9011, Textured Forge Grey	895.00
	HOLD-CST	23"	10 7/8"	19"	30 lbs.	Painted steel utility cart with one fixed shelf, methacrylate top and casters.	Textured White, Textured Black Ral9011, Textured Forge Grey	1,225.00
	HOLD OFC	29 1/4"	10 3/8"	15"	32 lbs.	Painted steel utility cart with one fixed shelf and methacrylate top.	Textured White, Textured Black Ral9011, Textured Forge Grey	1,095.00
	HOLD-OF-CST	32"	13 3/8"	15"	37 lbs.	Painted steel utility cart with one fixed shelf, methacrylate top and casters.	Textured White, Textured Black Ral9011, Textured Forge Grey	1,445.00
	HOLD HIGH	40 3/8"	9 7/8"	15 1/8"	51 lbs.	Painted steel utility cart with two fixed shelves and methacrylate top.	Textured White, Textured Black Ral9011, Textured Forge Grey	1,265.00
	HOLD HIGH-CST	43"	13 3/8"	15 1/8"	56 lbs.	Painted steel utility cart with two fixed shelves, methacrylate top and casters.	Textured White, Textured Black Ral9011, Textured Forge Grey	1,645.00

# HOLD DAILY

## CART FINISH COLORS



Textured White

## BOX FINISH COLORS



Textured Black



Textured Forge Grey





Textured White

## ADDITIONAL NOTES

Ships via common carrier.

Sample chips available.



LINE ART	MODEL	H	W	D	WEIGHT	DESCRIPTION	COLOR/FINISH	LIST PRICE
	HOLD-DAILY	36 1/4"	14 1/4"	19 1/8"	35 lbs.	Painted steel utility cart with one fixed shelf. 2 1/2" high casters included.	Textured White	1,745.00
	HOLD-DAILY-DR	36 1/4"	14 1/4"	19 1/8"	37 lbs.	Painted steel utility cart with one fixed shelf and locking door. 2 1/2" high casters included.	Textured White	2,035.00
	HOLD-DAILY-BOX	9 1/16"	9 1/8"	9 1/8"	2 lbs.	Painted metal storage box for use in either model above.	Textured White, Textured Forge Grey, Textured Black Ral 9011	345.00

# STORE

## CART FINISH COLORS



Textured Black



Textured Forge Grey



Textured White

## HANGING ACCESSORIES FINISH COLORS



Textured Black



Textured Forge Grey



Textured White



Mustard





Grey Beige

## ADDITIONAL NOTES

Ships via common carrier.

Sample chips available.



LINE ART	MODEL	H	W	D	WEIGHT	DESCRIPTION	COLOR/FINISH	LIST PRICE
	STORE-CST	25 3/4"	12 1/2"	21 1/2"	30 lbs.	Painted steel work space utility cart with one fixed shelf, a strap handle and color coordinated locking casters.	Textured White with Light Grey strap or Textured Black Ral 9011, with Anthracite Grey Strap or Textured Forge Grey with Anthracite Grey strap.	1,095.00
	STORE-MAG	11 7/8"	7 1/8"	1 9/16"	4 lbs.	Optional magazine shelf to hang on either side.	Textured White, Textured Black Ral 9011, Textured Forge Grey, Matte Grey Beige Ral 1019 or Mustard Gloss Ral 1012.	95.00
	STORE-SHELF	4 9/16"	7 3/16"	4 1/2"	2 lbs.	Optional side shelf to hang on either side of unit. Includes cup holder.(Cup not included)	Textured White, Textured Black Ral 9011, Textured Forge Grey, Matte Grey Beige Ral 1019 or Mustard Gloss Ral 1012.	145.00

# DESK ACCESSORIES

---

HOME → PRODUCTS → DESK ACCESSORIES

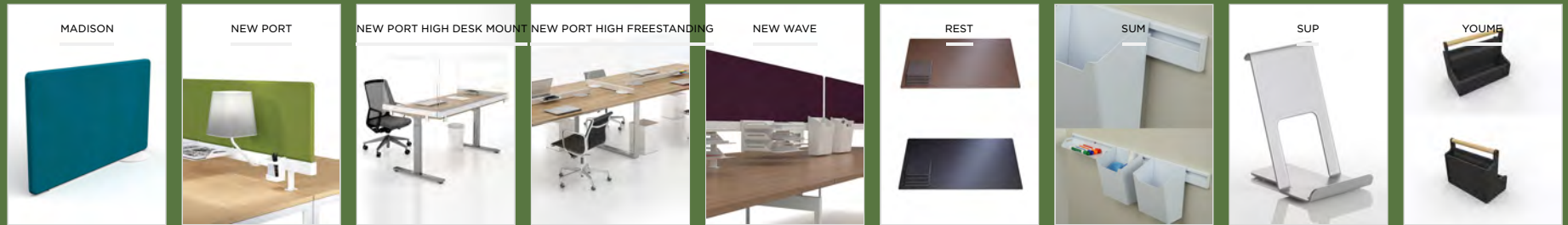

# MADISON

## FINISH COLORS



White



Black

## ATLANTIC COLLECTION FABRIC FINISH COLORS



Basalt 60999



Champagne 61166



Charcoal 60025



Fallow 63057



Jasper 64092

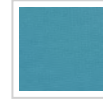

Maya 66063

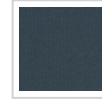

Mineral 60143

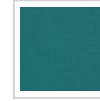

Nordic 67030

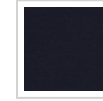

Prussia 66064

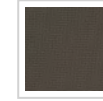

Shadow 61163

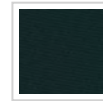

Storm 67043



String 61078



Zinc 60011

## ADDITIONAL NOTES

Ships via UPS.

MADISON can be ordered with the same or different color fabric on each side.

Painted steel base is 6 3/4" diameter.

Screen depth is 1 1/4".



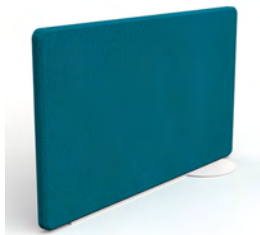

The sound absorption properties of MADISON start with an insulating core which is covered on both sides by a highly absorbent melamine foam. The weighted sound reduction index is 11 dB.

COM available upon approval - contact Customer Service for details.

Sample chips available.



LINE ART	MODEL	H	W	D	WEIGHT	DESCRIPTION	COLOR/FINISH	LIST PRICE
	MA-42-66	16 7/32"	26"	6 3/4"	15 lbs.	Desktop screen with acoustic fabric and one circular base on the side.	Base in White or Black; Acoustic Fabric Screens available in Atlantic fabrics: String 61078, Shadow 61163, Zinc 60011, Charcoal 60025, Storm 67043, Maya 66063, Prussia 66064, Mineral 60143, Nordic 67030, Basalt 60999, Jasper 64092, Fallow 63057, Champagne 61166.	670.00

	MA-42-80	16 7/32"	31 3/8"	6 3/4"	16 lbs.	Desktop screen with acoustic fabric and one circular base on the side.	Base in White or Black; Acoustic Fabric Screens available in Atlantic fabrics: String 61078, Shadow 61163, Zinc 60011, Charcoal 60025, Storm 67043, Maya 66063, Prussia 66064, Mineral 60143, Nordic 67030, Basalt 60999, Jasper 64092, Fallow 63057, Champagne 61166.	695.00
	MA-42-100	16 7/32"	39 3/8"	6 3/4"	18 lbs.	Desktop screen with acoustic fabric and one circular base on the side.	Base in White or Black; Acoustic Fabric Screens available in Atlantic fabrics: String 61078, Shadow 61163, Zinc 60011, Charcoal 60025, Storm 67043, Maya 66063, Prussia 66064, Mineral 60143, Nordic 67030, Basalt 60999, Jasper 64092, Fallow 63057, Champagne 61166.	735.00
	MA-42-120	16 7/32"	47 1/4"	6 3/4"	25 lbs.	Desktop screen with acoustic fabric and two circular bases on either side.	Base in White or Black; Acoustic Fabric Screens available in Atlantic fabrics: String 61078, Shadow 61163, Zinc 60011, Charcoal 60025, Storm 67043, Maya 66063, Prussia 66064, Mineral 60143, Nordic 67030, Basalt 60999, Jasper 64092, Fallow 63057, Champagne 61166.	785.00
	MA-42-140	16 7/32"	55 1/8"	6 3/4"	27 lbs.	Desktop screen with acoustic fabric and two circular bases on either side.	Base in White or Black; Acoustic Fabric Screens available in Atlantic fabrics: String 61078, Shadow 61163, Zinc 60011, Charcoal 60025, Storm 67043, Maya 66063, Prussia 66064, Mineral 60143, Nordic 67030, Basalt 60999, Jasper 64092, Fallow 63057, Champagne 61166.	875.00
	MA-42-160	16 7/32"	63"	6 3/4"	29 lbs.	Desktop screen with acoustic fabric and two circular bases on either side.	Base in White or Black; Acoustic Fabric Screens available in Atlantic fabrics: String 61078, Shadow 61163, Zinc 60011, Charcoal 60025, Storm 67043, Maya 66063, Prussia 66064, Mineral 60143, Nordic 67030, Basalt 60999, Jasper 64092, Fallow 63057, Champagne 61166.	975.00

# NEW PORT

## ATLANTIC COLLECTION FABRIC FINISH COLORS

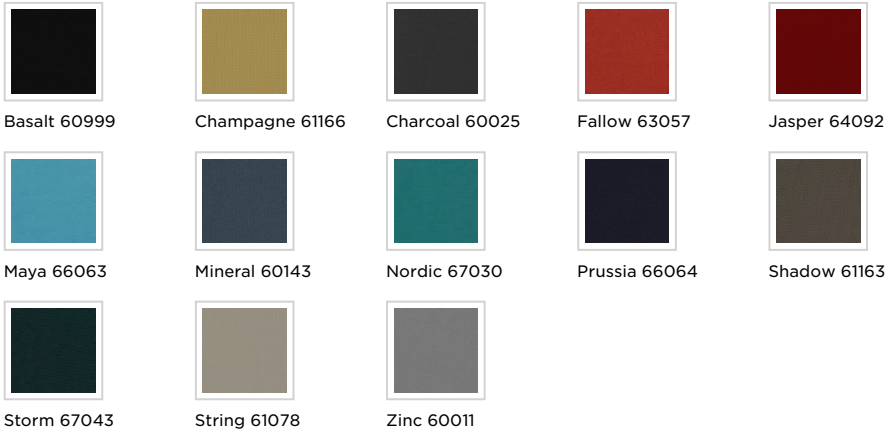

## ACOUSTIC PET FINISH COLORS



## HOW TO ORDER



**#1** Configure New Port Rail System

**#2** Select Mounting Setup

**#3** Select NewWave Accessories

- First, configure your New Port tool rail system by referring to the Tool Rail & Screen Specification Table below [Table I].
  - a. Select a tool rail length and finish color [Column A].
  - b. If specifying a tool rail without a screen, select a cover color and identify the appropriate model number based on tool rail length [Column B].
  - c. If specifying a tool rail with a screen, choose your desired screen material - Acoustic PET (and corresponding finish color), Acoustic Fabric (and corresponding finish color), Opaque, Tempered Glass or Writeable Glass; and identify the appropriate model number based on tool rail length [Column C].
- Next, select a mounting setup from the Mounting Specification Table [Table II].
  - a. Select a mounting height [above the desk] for the tool rail [Column A].
  - b. Next, select the appropriate mounting hardware for the desk and identify the appropriate model number based on mounting level [Column B].
- Finally, select your New Wave accessories which hang off of the New Wave tool rail.

## ADDITIONAL NOTES

Ships via common carrier.

Sample chips and fabric samples available.

NEW PORT is a flexible, versatile tool rail system that creates clean, personal “up and off the desk” organization which can be configured in a number of different ways, as follows:

- The NEW PORT tool rail is available in varying lengths to accommodate different desk sizes.
- The NEW PORT tool rail can include no privacy screen or a 15-3/8” high privacy screen made of acoustic fabric, acoustic PET, writeable glass or opaque tempered glass.
- The NEW PORT tool rail can be mounted to the desk at multiple heights, and in multiple ways.
- The NEW PORT tool rail can be used in single-sided or double-sided desk environments.
- The NEW PORT tool rail can accommodate a wide range of NEW WAVE desk accessories.

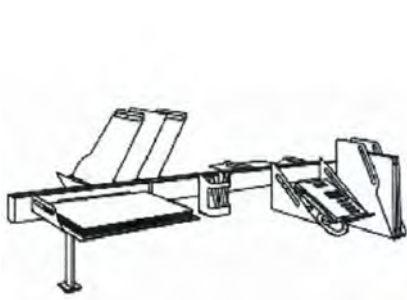

NEW PORT shown with no privacy screen

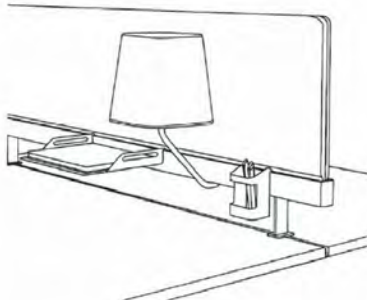

NEW PORT shown with privacy screen and NEW WAVE accessories



TABLE I - TOOL RAIL & SCREEN SPECIFICATION TABLE



A. Tool Rail (Including End Caps)	B. Tool Rail With No Screen		C. Tool Rail With Screen							
			Acoustic PET Screen		Acoustic Fabric Screen		Opaque Tempered Glass Screen		Writeable Glass Screen	
Tool Rail available in White, Sand, Silver or Black			Acoustic PET Screens available in Abyss, Alabaster, Amber, Chestnut, Cork, Dragee, Moss or Vermillion.		Acoustic Fabric finishes available from Atlantic or Roccia fabric collections.		While Supplies Last		While Supplies Last	
Tool Rail Length*	Model	List Price	Model	List Price	Model	List Price	Model	List Price	Model	List Price
21"	NP-53EP	\$210	NP-53CFA	\$398	NP-53CTA	\$540	NP-53CVO	\$605	NP-53CVT	\$775
31 1/2"	NP-80EP	\$236	NP-80CFA	\$420	NP-80CTA	\$610	NP-80CVO	\$650	NP-80CVT	\$830
39 3/8"	NP-100EP	\$265	NP-100CFA	\$485	NP-100CTA	\$705	NP-100CVO	\$755	NP-100CVT	\$950
47 1/4"	NP-120EP	\$295	NP-120CFA	\$570	NP-120CTA	\$815	NP-120CVO	\$845	NP-120CVT	\$1090
55 1/8"	NP-140EP	\$335	NP-140CFA	\$660	NP-140CTA	\$915	NP-140CVO	\$970	NP-140CVT	\$1260
63"	NP-160EP	\$375	NP-160CFA	\$805	NP-160CTA	\$995	NP-160CVO	\$1080	NP-160CVT	\$1420

\*Custom tool rail lengths available, contact Customer Service for details.

TABLE II - MOUNTING SPECIFICATION TABLE



A. Mounting Height	B. Mounting Type & Hardware					
	Single Sided Desk		Double Sided Desk		Through Desk*	
Mounting Level	Model	List Price	Model	List Price	Model	List Price
Desktop Level	NP-00P	\$150	NP-00M	\$98	NP-00F	\$98
3 15/16" Above Desk	NP-10P	\$198	NP-10M	\$155	NP-10F	\$155
7 7/8" Above Desk	NP-20P	\$198	NP-20M	\$155	NP-20F	\$155

\*The minimum hole size for mounting through the desk is 5/8". The Maximum desk thickness for single sided clamp is 1 5/8". Double sided or through desk maximum desk thickness is 2 1/4"

## TABLE III – OVERALL DIMENSIONS

Please note, the overall dimensions shown here include the tool rail, screen (if applicable) and mounting hardware.

Toolbar Length	Overall Dimensions – No Screen (Model NP-EP)											
	Desktop Level Mount				3 15/16" Above Desk Mount				7 7/8" Above Desk Mount			
	H	W	D	Shipping Weight	H	W	D	Shipping Weight	H	W	D	Shipping Weight
21"	2 3/8"	21"	1 11/16"	5 lbs	6 5/16"	21"	1 11/16"	7 lbs.	10 1/4"	21"	1 11/16"	8 lbs.
31 1/2"	2 3/8"	31 1/2"	1 11/16"	7 lbs	6 5/16"	31 1/2"	1 11/16"	9 lbs.	10 1/4"	31 1/2"	1 11/16"	10 lbs.
39 3/8"	2 3/8"	39 3/8"	1 11/16"	7 lbs	6 5/16"	39 3/8"	1 11/16"	9 lbs.	10 1/4"	39 3/8"	1 11/16"	10 lbs.
47 1/4"	2 3/8"	47 1/4"	1 11/16"	8 lbs	6 5/16"	47 1/4"	1 11/16"	10 lbs.	10 1/4"	47 1/4"	1 11/16"	11 lbs.
55 1/8"	2 3/8"	55 1/8"	1 11/16"	9 lbs	6 5/16"	55 1/8"	1 11/16"	11 lbs.	10 1/4"	55 1/8"	1 11/16"	12 lbs.
63"	2 3/8"	63"	1 11/16"	10 lbs	6 5/16"	63"	1 11/16"	12 lbs.	10 1/4"	63"	1 11/16"	13 lbs.

Toolbar Length	Overall Dimensions – With Screen (Models NP-CFA, CTA, CVO, CVT)											
	Desktop Level Mount				3 15/16" Above Desk Mount				7 7/8" Above Desk Mount			
	H	W	D	Shipping Weight	H	W	D	Shipping Weight	H	W	D	Shipping Weight
21"	17 3/4"	21"	1 11/16"	21 lbs	21 11/16"	21"	1 11/16"	23 lbs.	25 5/8"	21"	1 11/16"	24 lbs.
31 1/2"	17 3/4"	31 1/2"	1 11/16"	23 lbs	21 11/16"	31 1/2"	1 11/16"	25 lbs.	25 5/8"	31 1/2"	1 11/16"	26 lbs.
39 3/8"	17 3/4"	39 3/8"	1 11/16"	25 lbs	21 11/16"	39 3/8"	1 11/16"	27 lbs.	25 5/8"	39 3/8"	1 11/16"	28 lbs.
47 1/4"	17 3/4"	47 1/4"	1 11/16"	28 lbs	21 11/16"	47 1/4"	1 11/16"	30 lbs.	25 5/8"	47 1/4"	1 11/16"	31 lbs.
55 1/8"	17 3/4"	55 1/8"	1 11/16"	31 lbs	21 11/16"	55 1/8"	1 11/16"	33 lbs.	25 5/8"	55 1/8"	1 11/16"	34 lbs.
63"	17 3/4"	63"	1 11/16"	35 lbs	21 11/16"	63"	1 11/16"	37 lbs.	25 5/8"	63"	1 11/16"	38 lbs.

# NEW PORT HIGH DESK MOUNT

## FINISH COLORS



White



## ADDITIONAL NOTES

Ships via common carrier.

NEW PORT HIGH single sided C-clamp (i.e. model NP-76-CVC-S-00P) is compatible with worksurfaces ranging from 7/8" to 1 5/8" thick. C-clamp is not compatible with knife edge surfaces.







NEW PORT HIGH for mounting between worksurfaces (i.e. model NP-76-CVC-F-00M) is compatible with worksurfaces as thick as 2 1/4".



NEW PORT HIGH glass screen can be disinfected with a mild bleach or alcohol cleaner. NEW PORT tool rail can be cleaned with a mild, non-abrasive cleaner to preserve paint finish.

NEW PORT HIGH tool rail can accommodate a wide range of NEW WAVE desk accessories: NW-10 mail tray, NW-23NP locking box, NW-40 shelf or NW-80 pencil tray.

Additional finish colors available for painted aluminum tool rail, extended lead times apply - contact customer service for details.

Custom lengths available - extended lead times apply, contact customer service for details.

LINE ART	MODEL	H	W	D	WEIGHT	DESCRIPTION	COLOR/FINISH	LIST PRICE
	NP-76-CVC-S-00P	23 5/8"	29 15/16"	1 11/16"	21 lbs.	Painted aluminum tool rail with clear tempered glass screen. Includes mounting hardware for single sided worksurface edge (C-clamp).	White tool rail and mounting hardware with clear tempered glass screen.	715.00
	NP-100-CVC-S-00P	23 5/8"	39 3/8"	1 11/16"	26 lbs.	Painted aluminum tool rail with clear tempered glass screen. Includes mounting hardware for single sided worksurface edge (C-clamp).	White tool rail and mounting hardware with clear tempered glass screen.	755.00
	NP-120-CVC-S-00P	23 5/8"	47 1/4"	1 11/16"	31 lbs.	Painted aluminum tool rail with clear tempered glass screen. Includes mounting hardware for single sided worksurface edge (C-clamp).	White tool rail and mounting hardware with clear tempered glass screen.	865.00
	NP-140-CVC-S-00P	23 5/8"	55 1/8"	1 11/16"	36 lbs.	Painted aluminum tool rail with clear tempered glass screen. Includes mounting hardware for single sided worksurface edge (C-clamp).	White tool rail and mounting hardware with clear tempered glass screen.	940.00
	NP-160-CVC-S-00P	23 5/8"	63"	1 11/16"	41 lbs.	Painted aluminum tool rail with clear tempered glass screen. Includes mounting hardware for single sided worksurface edge (C-clamp).	White tool rail and mounting hardware with clear tempered glass screen.	1,005.00
	NP-76-CVC-F-00M	23 5/8"	29 15/16"	1 11/16"	21 lbs.	Painted aluminum tool rail with clear tempered glass screen. Includes mounting hardware for between two worksurfaces.	White tool rail and mounting hardware with clear tempered glass screen.	715.00
	NP-100-CVC-F-00M	23 5/8"	39 3/8"	1 11/16"	26 lbs.	Painted aluminum tool rail with clear tempered glass screen. Includes mounting hardware for between two worksurfaces.	White tool rail and mounting hardware with clear tempered glass screen.	755.00

	NP-120-CVC-F-00M	23 5/8"	47 1/4"	1 11/16"	31 lbs.	Painted aluminum tool rail with clear tempered glass screen. Includes mounting hardware for between two worksurfaces.	White tool rail and mounting hardware with clear tempered glass screen.	865.00
	NP-140-CVC-F-00M	23 5/8"	55 1/8"	1 11/16"	36 lbs.	Painted aluminum tool rail with clear tempered glass screen. Includes mounting hardware for between two worksurfaces.	White tool rail and mounting hardware with clear tempered glass screen.	940.00
	NP-160-CVC-F-00M	23 5/8"	63"	1 11/16"	41 lbs.	Painted aluminum tool rail with clear tempered glass screen. Includes mounting hardware for between two worksurfaces.	White tool rail and mounting hardware with clear tempered glass screen.	1,005.00

# NEW PORT HIGH FREESTANDING

## FINISH COLORS



White



## ADDITIONAL NOTES

Ships via common carrier.





Each round base has a 7 11/16" diameter.

NEW PORT HIGH glass screen can be disinfected with a mild bleach or alcohol cleaner. NEW PORT tool rail can be cleaned with a mild, non-abrasive cleaner to preserve paint finish.

NEW PORT tool rail can accommodate a wide range of NEW WAVE desk accessories: NW-10 mail tray, NW-23NP locking box, NW-40 shelf or NW-80 pencil tray.

Additional finish colors available for painted aluminum tool rail, extended lead times apply - contact customer service for details.

Custom lengths available - extended lead times apply, contact customer service for details.

LINE ART	MODEL	H	W	D	WEIGHT	DESCRIPTION	COLOR/FINISH	LIST PRICE
	NP-76-CVC-P	23 5/8"	29 15/16"	7 11/16"	22 lbs.	Freestanding painted aluminum tool rail with two round bases and clear tempered glass screen.	White tool rail and round bases with clear tempered glass screen.	715.00
	NP-100-CVC-P	23 5/8"	39 3/8"	7 11/16"	27 lbs.	Freestanding painted aluminum tool rail with two round bases and clear tempered glass screen.	White tool rail and round bases with clear tempered glass screen.	755.00
	NP-120-CVC-P	23 5/8"	47 1/4"	7 11/16"	32 lbs.	Freestanding painted aluminum tool rail with two round bases and clear tempered glass screen.	White tool rail and round bases with clear tempered glass screen.	865.00
	NP-140-CVC-P	23 5/8"	55 1/8"	7 11/16"	37 lbs.	Freestanding painted aluminum tool rail with two round bases and clear tempered glass screen.	White tool rail and round bases with clear tempered glass screen.	940.00
	NP-160-CVC-P	23 5/8"	63"	7 11/16"	42 lbs.	Freestanding painted aluminum tool rail with two round bases and clear tempered glass screen.	White tool rail and round bases with clear tempered glass screen.	1,005.00

# NEW WAVE

## FINISH COLORS



White



Black



Sand



Silver

## ADDITIONAL NOTES









Ships via UPS







NEW WAVE Accessories are painted steel accessories that can be used with the SUM wall mounted tool rail as well as on one or both sides of the NEW PORT desk mounted tool rail being used with or without privacy screens.

New Wave accessories fit Steelcase and Dirtt slat wall. New Wave accessories can in certain cases be used with, or customized to fit, other manufacturers' slat wall systems. Contact customer service for details.

Sample chips available.



LINE ART	MODEL	H	W	D	WEIGHT	DESCRIPTION	COLOR/FINISH	LIST PRICE
	NW-10	1 3/4"	13 1/2"	10 3/8"	4 lbs	Mail tray for use on New Port or Sum tool rail	White, Sand, Silver or Black	105.00
	NW-102	6 11/16"	13 1/2"	10 3/8"	9 lbs	Two stacked mail trays for use on New Port or Sum tool rail. Use with 3 15/16" or 7 7/8" uprights only	White, Sand, Silver or Black	295.00
	NW-103	10 1/4"	13 1/2"	10 3/8"	14 lbs	Three stacked mail trays for use on New Port or Sum tool rail. Use with 7 7/8" uprights only	White, Sand, Silver or Black	395.00
	NW-21	11 11/16"	10 7/16"	4 5/16"	2 lbs	Paper box for 8 1/2" x 11" paper for use on New Port or Sum tool rail. Use with 7 7/8" uprights only	White, Sand, Silver or Black	140.00
	NW-22	7 7/16"	5 3/8"	4 5/8"	2 lbs	Multi purpose storage cup for use on New Port or Sum tool rail. Use with 3 15/16" or 7 7/8" uprights only	White, Sand, Silver or Black	85.00
	NW-23NP	2"	11 13/16"	9 7/8"	5 lbs.	Locking box to secure digital tools (iPad, smartphone, etc.) on New Port tool rail. Includes cable hole to allow connection for charger. Use with 3 15/16" or 7 7/8" uprights only	White, Sand, Silver or Black	250.00
	NW-23SUM	2"	11 13/16"	9 7/8"	5 lbs.	Locking box to secure digital tools (iPad, smartphone, etc.) on SUM tool rail. Includes cable hole to allow connection for charger	White, Sand, Silver or Black	250.00
	NW-30	4 13/16"	3 1/4"	2 1/2"	1 lb.	Pencil cup for use on New Port or Sum tool rail. Use with 3 15/16" or 7 7/8" uprights only	White, Sand, Silver or Black	55.00
	NW-40	1 7/8"	17 5/16"	10 3/8"	5 lbs.	Shelf with pencil tray for use on New Port or Sum tool rail	White, Sand, Silver or Black	145.00

	NW-52	6 7/8"	11"	10 1/4"	2 lbs.	Phone support tray for use on New Port or Sum tool rail. Use with 3 15/16" or 7 7/8" uprights only	White, Sand, Silver or Black	135.00
	NW-60	10 3/8"	13 5/8"	9 7/8"	6 lbs	3 section sorter for use on New Port or Sum tool rail. Use with 3 15/16" or 7 7/8" uprights only	White, Sand, Silver or Black	195.00
	NW-70	13 13/16"	4"	10 1/4"	5 lbs	Binder support for use on New Port or Sum tool rail. Use with 7 7/8" uprights only	White, Sand, Silver or Black	115.00
	NW-80	1 5/16"	10 1/4"	3 5/16"	1 lb.	Pencil tray for use on New Port or Sum tool rail	White, Sand, Silver or Black	65.00
	SU-82-NW	11 13/16"	11 13/16"	1"	1 lb.	Tackable board for use on New Port or Sum tool rail. Use with 7 7/8" uprights only	White, Sand, Black or Silver frame with trackable surface in Anthracite	175.00
	MELO-NP-TM	16"	8 3/4"	8 3/4"	3 lbs.	Lamp with square shade that attaches to top of NewPort tool rail with no screen. Use with tool rail with no screen only.	Shade in White, Red or Purple. Arm in White, Sand, Silver or Black.	535.00
	MELO-NP-UM	17 1/2"	8 3/4"	8 3/4"	3 lbs.	Lamp with square shade that mounts below New Port tool rail when using a screen. Use with 3 15/16" or 7 7/8" uprights only	Shade in White, Red or Purple. Arm in White, Sand, Silver or Black.	535.00



# REST

## ADDITIONAL NOTES







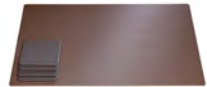

Ships via UPS

REST faux leather desk pads can be embossed with a logo, contact Customer Service for details.

REST Antimicrobial models use CF Stinson® STP60 Raven fabric which contains an antimicrobial agent which inhibits the growth of microbes on the protected surface.

Sample chips available.



LINE ART	MODEL	H	W	D	WEIGHT	DESCRIPTION	COLOR/FINISH	LIST PRICE
	REST-FL-04	16"	22"	3/16"	1 lbs.	Faux leather large desk pad	Black 803, Regimental Blue 821, Elephant 828, Grey 808, Sea Oyster 827, Cayenne 901, Meadow 894, Reef 897, Ash 806, Beechwood 860.	199.00
	REST-FL-05	12"	18"	3/16"	1 lbs.	Faux leather small desk pad	Black 803, Regimental Blue 821, Elephant 828, Grey 808, Sea Oyster 827, Cayenne 901, Meadow 894, Reef 897, Ash 806, Beechwood 860.	170.00
	REST-FL-07	4 1/2"	4 1/2"	3/16"	1 lbs.	Set of four coasters in faux leather	Black 803, Regimental Blue 821, Elephant 828, Grey 808, Sea Oyster 827, Cayenne 901, Meadow 894, Reef 897, Ash 806, Beechwood 860.	160.00
	REST-AM-04	16"	22"	3/16"	1 lbs.	Antimicrobial faux leather large desk pad	Black	230.00
	REST-AM-05	12"	18"	3/16"	1 lbs.	Antimicrobial faux leather small desk pad	Black	195.00
	REST-AM-07	4 1/2"	4 1/2"	3/16"	1 lbs.	Set of four coasters in antimicrobial faux leather	Black	185.00
	REST-LT-04	16"	22"	3/16"	1 lbs.	Leather large desk pad	Black	580.00
	REST-LT-05	12"	18"	3/16"	1 lbs.	Leather small desk pad	Black	395.00

REST-LT-07

4 1/2"

4 1/2"

3/16"

1 lbs.

Set of four leather coasters

Black

160.00

# SUM

## FINISH COLORS



White



Black



Sand



Silver

## ADDITIONAL NOTES

Ships via UPS

Sum is a wall mounted painted steel tool rail that works with New Wave accessories.

Sample chips available.



LINE ART	MODEL	H	W	D	WEIGHT	DESCRIPTION	COLOR/FINISH	LIST PRICE
	SUM-80	2"	31 1/2"	1/2"	3 lbs.	Painted steel wall mounted tool rail for use with new wave accessories	White, Sand, Silver or Black	95.00
	SUM-100	2"	39 3/8"	1/2"	4 lbs.	Painted steel wall mounted tool rail for use with new wave accessories	White, Sand, Silver or Black	115.00
	SUM-120	2"	47 1/4"	1/2"	5 lbs.	Painted steel wall mounted tool rail for use with new wave accessories	White, Sand, Silver or Black	125.00
	SUM-140	2"	55 1/8"	1/2"	6 lbs.	Painted steel wall mounted tool rail for use with new wave accessories	White, Sand, Silver or Black	145.00
	SUM-160	2"	63"	1/2"	7 lbs.	Painted steel wall mounted tool rail for use with new wave accessories	White, Sand, Silver or Black	155.00



ADDITIONAL NOTES

---

Ships via UPS

Sample chips available.



LINE ART	MODEL	H	W	D	WEIGHT	DESCRIPTION	COLOR/FINISH	LIST PRICE
	SUP-PHONE	3 5/8"	2 3/8"	2 7/8"	1 lbs.	Desktop stand for smartphone	White, Sand, Black or Silver	67.00
	SUP-TABLET	5 3/4"	8 7/8"	4 3/16"	2 lbs.	Desktop stand for tablet	White, Sand, Black or Silver	120.00

## FINISH COLORS



Light Grey PET



Dark Grey PET

## ADDITIONAL NOTES

Ships via UPS

Constructed of 1/2" thick PET made with recycled content and featuring sound absorption properties.

Front interior compartment dimensions: 13" W x 3 5/8" D x 3 3/4"H. Back interior compartment dimensions: 13" W x 1 7/16" D x 8" H.

Sample chips available.



LINE ART	MODEL	H	W	D	WEIGHT	DESCRIPTION	COLOR/FINISH	LIST PRICE
	YM20-CH	11 11/16"	14"	7 5/16"	3 lbs.	Personal caddy for laptops, tablets and other items made of Recycled PET with an Oak handle.	Dark Grey PET outer shell with Oak handle. Interior divider panel in Dark Grey or Light Grey with Dark Grey elastic strap.	295.00
	YM30	4 7/16"	3 5/16"	2 1/2"	1 lb.	Pen box for YOUME caddy.	Clear plastic.	30.00

# MAGAZINE RACKS

HOME → PRODUCTS → MAGAZINE RACKS



COMPACT SOISTES



CUBIC SOISTES



FLAP



IFLAG



RACK SOISTES

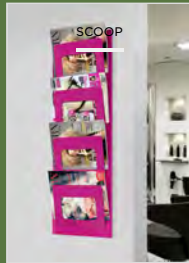

SCOOP



USIQ



WALLMATE SOISTES

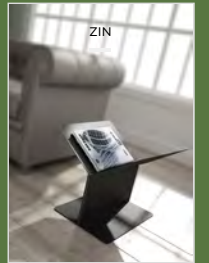

ZIN

# COMPACT SOISTES

## ADDITIONAL NOTES

Ships via common carrier.



LINE ART	MODEL	H	W	D	WEIGHT	DESCRIPTION	COLOR/FINISH	LIST PRICE
	SOCC-4A4	68 11/16"	13 3/4"	11 13/16"	60 lbs.	Free standing literature display with four shelves that are height adjustable on frame. Shelves can be set horizontally or at 30, 60 or 90 degrees.	Silver Anodized Aluminum frame. Silver painted base, polycarbonate shelves.	1,450.00

# CUBIC SOISTES

## ADDITIONAL NOTES

Ships via common carrier.



LINE ART	MODEL	H	W	D	WEIGHT	DESCRIPTION	COLOR/FINISH	LIST PRICE
	SOCU-1100	43 5/16"	13"	12 13/16"	30 lbs.	Catalog or magazine stand with two shelves.	Silver Anodized Aluminum frame, painted Silver shelves and base	1,575.00

# FLAP

## SHELVES FINISH COLORS



Textured Forge Grey



White



Satin Black RAL 9011

## FRAME FINISH COLORS





Anodized Aluminum

## ADDITIONAL NOTES

Ships via common carrier.

Sample chips available.



LINE ART	MODEL	H	W	D	WEIGHT	DESCRIPTION	COLOR/FINISH	LIST PRICE
	FLAP-3	35 7/16"	29 1/2"	7 1/16"	28 lbs.	Wall mounted magazine and literature display with three steel shelves.	Frame is Silver Anodized Aluminum, shelves and base in Satin Black Ral 9011, Textured Forge Grey or Matte White Ral 9003	1,845.00
	FLAP-4	47 1/4"	29 1/2"	7 1/16"	34 lbs.	Wall mounted magazine and literature display with four steel shelves.	Frame is Silver Anodized Aluminum, shelves and base in Satin Black Ral 9011, Textured Forge Grey or Matte White Ral 9003	2,345.00

# IFLAG

## POST FINISH COLORS



Anodized Aluminum

## BASE FINISH COLORS



Textured Forge Grey



White









Satin Black RAL 9011

## ADDITIONAL NOTES

Ships via FedEx



LINE ART	MODEL	H	W	D	WEIGHT	DESCRIPTION	COLOR/FINISH	LIST PRICE
	IFLAG-10	50 13/16"	9 13/16"	17 11/16"	12 lbs.	Transparent methacrylate display for single poster/paper that is 8 1/4" x 11 11/16".	Post in Anodized Silver, base in Textured Forge Grey, Matte White Ral 9003 or Satin Black RAL 9011	785.00
	IFLAG-20	50 13/16"	9 13/16"	17 11/16"	14 lbs.	Transparent methacrylate display for two posters/papers that are 8 1/4" x 11 11/16".	Post in Anodized Silver, base in Textured Forge Grey, Matte White Ral 9003 or Satin Black RAL 9011	1,045.00
	IFLAG-30	50 13/16"	9 13/16"	17 11/16"	19 lbs.	Transparent methacrylate display for three posters/papers that are 8 1/4" x 11 11/16".	Post in Anodized Silver, base in Textured Forge Grey, Matte White Ral 9003 or Satin Black RAL 9011	1,345.00
	IFLAG-40	50 13/16"	9 13/16"	17 11/16"	12 lbs.	Transparent methacrylate display featuring a single shelf for brochures that are 8 1/4"x 11 11/16". Single sheet can also be inserted between methacrylate with brochures or papers on the shelf for take away.	Post in Anodized Silver, base in Textured Forge Grey, Matte White Ral 9003 or Satin Black RAL 9011	865.00
	IFLAG-50	50 13/16"	9 13/16"	17 11/16"	14 lbs.	Transparent methacrylate display featuring two shelves for brochures that are 8 1/4"x 11 11/16". Single sheet can also be inserted between methacrylate with brochures or papers on the shelf or shelves below for take away.	Post in Anodized Silver, base in Textured Forge Grey, Matte White Ral 9003 or Satin Black RAL 9011	1,155.00
	IFLAG-60	50 13/16"	9 13/16"	17 11/16"	19 lbs.	Transparent methacrylate display featuring three shelves for brochures that are 8 1/4"x 11 11/16". Single sheet can also be inserted between methacrylate with brochures or papers on the shelf or shelves for take away.	Post in Anodized Silver, base in Textured Forge Grey, Matte White Ral 9003 or Satin Black RAL 9011	1,495.00





# RACK SOISTES

## ADDITIONAL NOTES

Ships via common carrier.





LINE ART	MODEL	H	W	D	WEIGHT	DESCRIPTION	COLOR/FINISH	LIST PRICE
	SORA6-A4	40 9/16"	28 1/4"	16 15/16"	30 lbs.	Magazine rack with 2 shelves that can be inclined independently in three positions. Each shelf is freely adjustable in height and can hold three magazines that are 8 1/2" x 11" in size. Shelves can be set flat, horizontally or tilted at 30, 60 or 90 degrees. Lip on shelves is 1 3/16". Include locking casters.	Silver Anodized Aluminum frame, satin acrylic shelves.	1,675.00
	SORA9-A4	73 5/8"	28 3/4"	16 15/16"	33 lbs.	Magazine rack with 3 shelves that can be inclined independently in three positions. Each shelf is freely adjustable in height and can hold three magazines that are 8 1/2" x 11" in size. Shelves can be set flat, horizontally or tilted at 30, 60 or 90 degrees. Lip on shelves is 1 3/16". Includes locking casters.	Silver Anodized Aluminum frame, satin acrylic shelves.	2,195.00

# SCOOP

## ADDITIONAL NOTES

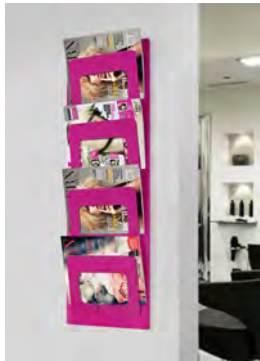
Ships via FedEx



LINE ART	MODEL	H	W	D	WEIGHT	DESCRIPTION	COLOR/FINISH	LIST PRICE
	SCOOP	38 5/8"	12 5/8"	1/8"-2 3/4"	11 lbs.	Wall mounted newspaper/magazine display with four pockets. Painted steel finish. Pockets expand to 2 3/4" to hold varying sized media.	White, Green or Pink	460.00

## COLUMN FINISH COLORS



Anodized Aluminum

## SHELVES FINISH COLORS



Black



Textured Forge Grey



White



## ADDITIONAL NOTES

Usio-W ships via FedEx; Usio-FS/FD ship via common carrier.

All Usio shelves are 6 1/8" apart.

Sample chips available.



LINE ART	MODEL	H	W	D	WEIGHT	DESCRIPTION	COLOR/FINISH	LIST PRICE
	USIO-W	64 1/2"	6 1/4"	6 1/8"	21 lbs.	Wall mounted bookshelf with aluminum center column with 10 painted steel fixed height shelves.	Anodized Silver Matte column, shelves in Textured Forge Grey, Matte White Ral 9003 or Satin Black Ral 9011	925.00
	USIO-FS	64 9/16"	9 3/4"	9 7/8"	35 lbs.	Floor standing single sided bookshelf with aluminum center column with 10 painted steel fixed height shelves.	Anodized Silver Matte column, shelves in Textured Forge Grey, Matte White Ral 9003 or Satin Black Ral 9011	1,475.00
	USIO-FD	64 9/16"	9 3/4"	19 3/4"	57 lbs.	Floor standing double sided bookshelf with aluminum center column with 20 painted steel fixed height shelves.	Anodized Silver Matte column, shelves in Textured Forge Grey, Matte White Ral 9003 or Satin Black Ral 9011	2,195.00

# WALLMATE SOISTES

## ADDITIONAL NOTES

Ships via common carrier.



LINE ART	MODEL	H	W	D	WEIGHT	DESCRIPTION	COLOR/FINISH	LIST PRICE
	SOWM-960	37 13/16"	37 13/16"	9 5/8"	25 lbs.	Wall mounted magazine or catalog display with three shelves that are adjustable in height on frame.	Silver Anodized Aluminum frame, shelves in satin acrylic.	2,075.00
	SOCF-1515				1 lb.	Set of two brackets for top of WallMate to hold signage up to 1/8" thick.	Silver	69.00

## ZIN-10 FINISH COLORS



Textured Black



Textured Forge Grey



Textured White

## ZIN-20/30 FINISH COLORS



Black



White





Light Grey Screen Fabric

## ADDITIONAL NOTES

Ships via FedEx

Sample chips available.



LINE ART	MODEL	H	W	D	WEIGHT	DESCRIPTION	COLOR/FINISH	LIST PRICE
	ZIN-10	14 9/16"	17 1/16"	15 3/4"	19 lbs.	Magazine rack in textured painted steel.	Textured White, Textured Black or Textured Forge Grey	775.00
	ZIN-20	15 7/8"	15 3/4"	15 9/16"	7 lbs.	Magazine rack with painted steel frame and Light Grey screen fabric.	Satin Black Ral 9011 or Matte White Ral 9003 Frame with Light Grey Screen Fabric	1,065.00
	ZIN-30	15 7/8"	15 3/4"	15 9/16"	7 lbs.	Magazine rack with chrome frame and Light Grey screen fabric.	Chrome frame with Light Grey Screen Fabric	1,195.00

# SPACE DIVIDERS

---

HOME → PRODUCTS → SPACE DIVIDERS

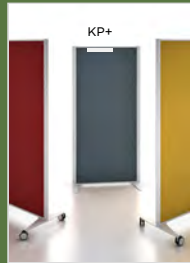

FINISH COLORS



Willow



Waterfall



Sunshine



Straw



Slate



Quarry Blue



Orchid



Green Apple



Geranium

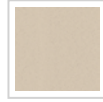

Birch

ADDITIONAL NOTES

Ships via common carrier.

TSCA Title VI Compliant.

Standard base feet & caster base assembly feet make the unit 18" deep. KP+ screen frame is 1" deep.

Determine the required number of caster assemblies by adding together the total number of connection points + 2 (one for each end). For example, if 3 units are to be joined together, 4 total caster assemblies are required - 2 connection points + 2 (1 for each end) = 4 caster assemblies required. If a single, standalone unit is to be used on casters, 2 caster assemblies are required, one for each end.

Any fabric from the Guilford of Maine Anchorage Collection is compatible with KP+ Space Dividers.

Sample chips and fabric samples available.



LINE ART	MODEL	H	W	D	WEIGHT	DESCRIPTION	COLOR/FINISH	LIST PRICE
	KP TS	64 1/2"	31 15/16"	18"	46 lbs.	Free standing moveable screen with steel frame and fabric clad panel.	Frame: Argent Silver or White. Fabric Panel: Birch, Geranium, Green Apple, Orchid, Quarry Blue, Slate, Straw, Sunshine, Waterfall or Willow	1,045.00
	KPI TS	64 1/2"	47 1/4"	18"	63 lbs.	Free standing moveable screen with steel frame and fabric clad panel.	Frame: Argent Silver or White. Fabric Panel: Birch, Geranium, Green Apple, Orchid, Quarry Blue, Slate, Straw, Sunshine, Waterfall or Willow	1,075.00
	KP PC	64 1/2"	31 15/16"	18"	27 lbs.	Free standing moveable screen with steel frame and translucent polycarbonate panel	Frame: Argent Silver or White with polycarbonate	1,165.00
	KPI PC	64 1/2"	47 1/4"	18"	47 lbs.	Free standing moveable screen with steel frame and translucent polycarbonate panel	Frame: Argent Silver or White with polycarbonate	1,295.00
	KP Caster Assembly-1				15 lbs.	Single Caster assembly for KP+ screens add 3 1/4" to height of unit. Determine the required number of caster assemblies by adding together the total number of connection points + 2 (one for each end).	Argent Silver or White	175.00

# MADISON

## FINISH COLORS



White



Black

## ATLANTIC COLLECTION FABRIC FINISH COLORS

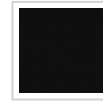

Basalt 60999



Champagne 61166



Charcoal 60025



Fallow 63057



Jasper 64092

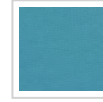

Maya 66063

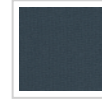

Mineral 60143

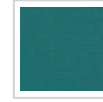

Nordic 67030

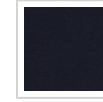

Prussia 66064

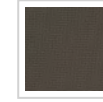

Shadow 61163

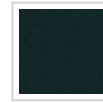

Storm 67043



String 61078



Zinc 60011

## ADDITIONAL NOTES

Ships via common carrier.

MADISON can be ordered with the same or contrasting color fabric on each side.

When ordering MADISON with a zipper and contrasting color fabrics, the first color will be the side with the zipper on the left and the second color will be side with the zipper on the right. For example, MA-160-80-Z in String 61078/Shadow 61163 - where, when looking at the product, the side with String 61078 has the zipper on the right with the receiving end on the left and the side with Shadow 61163 has the zipper on the left with the receiving end on the right.

There is no known limitation to how many panels can be zipped together, nor whether a return (panel at 90 degree angle) is needed for stability.

Zipper color matches the base paint finish - Black or White. When connected by zipper, units can be positioned in a straight line or at an angle.





Screen depth is 1 1/4".

The sound absorption properties of MADISON start with an insulating core which is covered on both sides by a highly absorbent melamine foam. The weighted sound reduction index is 11 dB.

COM available upon approval - contact Customer Service for details.

Sample chips available.



LINE ART	MODEL	H	W	D	WEIGHT	DESCRIPTION	COLOR/FINISH	LIST PRICE
	MA-160-80	63"	31 3/8"	11 3/8"	54 lbs.	Freestanding space divider with acoustic fabric.	Base in White or Black; Acoustic Fabric Screens available in Atlantic fabrics: String 61078, Shadow 61163, Zinc 60011, Charcoal 60025, Storm 67043, Maya 66063, Prussia 66064, Mineral 60143, Nordic 67030, Basalt 60999, Jasper 64092, Fallow 63057, Champagne 61166.	1,815.00
	MA-160-80-Z	63"	32"	11 3/8"	54 lbs.	Freestanding space divider with acoustic fabric and connecting zipper feature.	Base in White or Black; Acoustic Fabric Screens available in Atlantic fabrics: String 61078, Shadow 61163, Zinc 60011, Charcoal 60025, Storm 67043, Maya 66063, Prussia 66064, Mineral 60143, Nordic 67030, Basalt 60999, Jasper 64092, Fallow 63057, Champagne 61166.	1,950.00
	MA-160-100	63"	39 3/8"	11 3/8"	60 lbs.	Freestanding space divider with acoustic fabric.	Base in White or Black; Acoustic Fabric Screens available in Atlantic fabrics: String 61078, Shadow 61163, Zinc 60011, Charcoal 60025, Storm 67043, Maya 66063, Prussia 66064, Mineral 60143, Nordic 67030, Basalt 60999, Jasper 64092, Fallow 63057, Champagne 61166.	2,025.00
	MA-160-100-Z	63"	40"	11 3/8"	60 lbs.	Freestanding space divider with acoustic fabric and connecting zipper feature.	Base in White or Black; Acoustic Fabric Screens available in Atlantic fabrics: String 61078, Shadow 61163, Zinc 60011, Charcoal 60025, Storm 67043, Maya 66063, Prussia 66064, Mineral 60143, Nordic 67030, Basalt 60999, Jasper 64092, Fallow 63057, Champagne 61166.	2,165.00



# MALVA

## BASE & FRAME FINISH COLORS



Black



White



Textured Forge Grey

## FABRIC PANEL FINISH COLORS



Grey Anthracite Screen Fabric





Light Grey Screen Fabric

## ADDITIONAL NOTES

Ships via common carrier.

Sample chips available.



LINE ART	MODEL	H	W	D	WEIGHT	DESCRIPTION	COLOR/FINISH	LIST PRICE
	MALVA-16	63"	37 1/8"	14 5/8"	47 lbs.	Sight divider screen with painted aluminum frame and steel base, seven mesh fabric panels.	Frame and base in Matte White Ral 9003, Textured Forged Grey or Satin Black Ral 9011. Mesh screen fabric in Anthracite Grey or Light Grey.	3,195.00
	MALVA-H7	75 5/8"	37 1/8"	14 5/8"	49 lbs.	Sight divider screen with painted aluminum frame and steel base, seven mesh fabric panels.	Frame and base in Matte White Ral9003, Textured Forged Grey or Satin Black Ral 9011. Mesh screen fabric in Anthracite Grey or Light Grey.	3,695.00

# PARBAN

## FINISH COLORS



Matte White



Textured Forge Grey



Grey Beige





Black

## ADDITIONAL NOTES

Ships via common carrier.

Sample chips available.



LINE ART	MODEL	H	W	D	WEIGHT	DESCRIPTION	COLOR/FINISH	LIST PRICE
	PARBAN-S	50 1/8"	37 3/8"	18"	30 lbs.	Semi-transparent partition with painted aluminum frame and aluminum mesh screen with steel legs covered with natural oak.	Frame and Screen Mesh in Matte White RAL 9003, Textured Forge Grey, Satin Black RAL 9011 or Matte Grey Beige RAL 1019 with Matte Oak Legs	3,195.00
	PARBAN-L	70"	37 3/8"	18"	32 lbs.	Semi-transparent partition with painted aluminum frame and aluminum mesh screen with steel legs covered with natural oak.	Frame and Screen Mesh in Matte White RAL 9003, Textured Forge Grey, Satin Black RAL 9011 or Matte Grey Beige RAL 1019 with Matte Oak Legs	3,545.00

# STOOLS

---

HOME → PRODUCTS → STOOLS



# CALMA

## SEAT FINISH COLORS



Black



Green



White

## SPECIAL ORDER SEAT FINISH COLORS



Beige



Dark Blue



Orange



Pearl Grey



Red

## FRAME FINISH COLORS



White

## ADDITIONAL NOTES

Ships via common carrier.



Seat height is 30 5/16"

Calma meets or exceeds the minimum requirements per ANSI/BIFMA X5.1-2011 office chairs.

Sample chips available.

Sold in cartons of 4 only.



LINE ART	MODEL	H	W	D	WEIGHT	DESCRIPTION	COLOR/FINISH	LIST PRICE
	CALMA	35"	14 1/2"	14 3/16"	44 lbs.	Bar height stool made of technopolymer seat with painted frame. Stackable 5 high for storage. Suitable for indoor and outdoor use. Assembly required. Sold in cartons of 4 only.	Frame in White, seat in Black, White, Green	1,695.00 <b>Sold in cartons of 4 only.</b>
	CALMA-SO	35"	14 1/2"	14 3/16"	44 lbs.	Bar height stool made of technopolymer seat with painted frame. Stackable 5 high for storage. Suitable for indoor and outdoor use. Assembly required. Sold in cartons of 4 only.	Beige, Red, Dark Blue, Pearl Grey and Orange as special order.	1,845.00 <b>Sold in cartons of 4 only.</b>

# GINLET

## FINISH COLORS



Beige Grey RAL  
7006



Black Grey RAL  
7021



Olive Green RAL  
6003





## ADDITIONAL NOTES

Ships via common carrier.

Ginlet-K seat height is 24".

Ginlet-B seat height is 31 5/8".

Ginlet meets or exceeds the minimum requirements per ANSI/BIFMA X5.1-2011 office chairs.

LINE ART	MODEL	H	W	D	WEIGHT	DESCRIPTION	COLOR/FINISH	LIST PRICE
	GINLET-K	25 9/16"	19 5/16"	15 3/8"	16 lbs.	Counter height stool with polyurethane swivel seat, painted frame and chrome foot rest. Seat height is 24".	Seat and frame in Black RAL 9004, Olive Green RAL 6003 or Beige Grey RAL 7006 with chrome footrest	1,195.00
	GINLET-B	32 11/16"	19 5/16"	15 3/8"	17 lbs.	Bar height stool with polyurethane swivel seat, painted frame and chrome foot rest. Seat height is 31 5/8".	Seat and frame in Black RAL 9004, Olive Green RAL 6003 or Beige Grey RAL 7006 with chrome footrest	1,265.00

# ISIDORO

## FINISH COLORS



Pearl Grey



White

## SPECIAL ORDER FINISH COLORS



Bordeaux



Dark Grey



Sage Green



Sand



Turtledove

## ADDITIONAL NOTES

Ships via common carrier.



Seat height is 30 1/8".

Isidoro meets or exceeds the minimum requirements per ANSI/BIFMA X5.1-2011 office chairs.

Sample chips available.

Sold in cartons of 4 only.



LINE ART	MODEL	H	W	D	WEIGHT	DESCRIPTION	COLOR/FINISH	LIST PRICE
	ISI-STL	38 3/16"	18 29/32"	18 1/8"	45 lbs.	Bar height stool made of technopolymer with co-injected metal frame. Stackable 6 high for storage. Suitable for indoor and outdoor use. Sold in Cartons of 4 only.	White or Pearl Grey	1,535.00 <b>Sold in cartons of 4 only.</b>
	ISI-STL-SO	38 3/16"	18 29/32"	18 1/8"	45 lbs.	Bar height stool made of technopolymer with co-injected metal frame. Stackable 6 high for storage. Suitable for indoor and outdoor use. Sold in Cartons of 4 only.	Sage Green, Bordeaux, Turtledove, Sand or Dark Grey	1,645.00 <b>Sold in cartons of 4 only.</b>

# RIVISTA

## STANDARD SEAT & INSERT FINISH COLORS



Black Seat White Insert



White Seat Grey Insert

## SPECIAL ORDER SEAT & INSERT FINISH COLORS



Red Seat White Insert



Turtledove Seat White Insert

## FRAME FINISH COLORS



White

## ADDITIONAL NOTES

Ships via common carrier.



Seat height is 30 3/4"

Rivista meets or exceeds the minimum requirements per ANSI/BIFMA X5.1-2011 office chairs.

Sample chips available.

Sold in cartons of 4 only.



LINE ART	MODEL	H	W	D	WEIGHT	DESCRIPTION	COLOR/FINISH	LIST PRICE
	RIVISTA-STL	47 11/16"	17 3/4"	17 3/4"	49 lbs.	Bar height stool made of techno polymer seat with painted frame. Stackable 4 high for storage. Suitable for indoor and outdoor use. Assembly required. Sold in Cartons of 4 only.	Frame in White, seat in White with Grey insert or Black with White insert	1,975.00 <b>Sold in cartons of 4 only.</b>
	RIVISTA-STL-SO	47 11/16"	17 3/4"	17 3/4"	44 lbs.	Bar height stool made of techno polymer seat with painted frame. Stackable 4 high for storage. Suitable for indoor and outdoor use. Assembly required. Sold in Cartons of 4 only.	Red with White insert, Turtledove with White insert as special order	2,195.00 <b>Sold in cartons of 4 only.</b>

# OCCASIONAL TABLES

---

HOME → PRODUCTS → OCCASIONAL TABLES

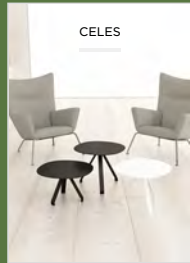



# CELES

## FINISH COLORS



Black



White



Mustard



Grey Beige



Matte Oak

## ADDITIONAL NOTES

Ships via UPS

Sample chips available.



LINE ART	MODEL	H	W	D	WEIGHT	DESCRIPTION	COLOR/FINISH	LIST PRICE
	CELES-S	11 11/16"	19 1/2"	18 3/4"	13 lbs.	Side table constructed of painted aluminum for indoor and outdoor use.	Matte Grey Beige Ral 1019, Mustard Gloss Ral 1012, Satin Black Ral 9011 or Matte White Ral 9003	1,895.00
	CELES-S-OAK	11 11/16"	19 1/2"	18 3/4"	13 lbs.	Side table constructed of painted steel legs with laminated matte oak tabletop for indoor use only.	Matte Grey Beige Ral 1019, Mustard Gloss Ral 1012, Satin Black Ral 9011 or Matte White Ral 9003 with Matte Oak tabletop	1,545.00
	CELES-M	13 5/8"	19 1/2"	18 3/4"	13 lbs.	Side table constructed of painted aluminum for indoor and outdoor use.	Matte Grey Beige Ral 1019, Mustard Gloss Ral 1012, Satin Black Ral 9011 or Matte White Ral 9003	1,895.00
	CELES-M-OAK	13 5/8"	19 1/2"	18 3/4"	13 lbs.	Side table constructed of painted steel legs with laminated matte oak tabletop for indoor use only.	Matte Grey Beige Ral 1019, Mustard Gloss Ral 1012, Satin Black Ral 9011 or Matte White Ral 9003 with Matte Oak tabletop	1,565.00
	CELES-L	15 5/8"	19 1/2"	18 3/4"	14 lbs.	Side table constructed of painted aluminum for indoor and outdoor use.	Matte Grey Beige Ral 1019, Mustard Gloss Ral 1012, Satin Black Ral 9011 or Matte White Ral 9003	1,945.00
	CELES-L-OAK	15 5/8"	19 1/2"	18 3/4"	14 lbs.	Side table constructed of painted steel legs with laminated matte oak tabletop for indoor use only.	Matte Grey Beige Ral 1019, Mustard Gloss Ral 1012, Satin Black Ral 9011 or Matte White Ral 9003 with Matte Oak tabletop	1,585.00
	CELES-XL	17 7/8"	26 3/8"	27 1/2"	21 lbs.	Side table constructed of painted aluminum for indoor and outdoor use.	Matte Grey Beige Ral 1019, Mustard Gloss Ral 1012, Satin Black Ral 9011 or Matte White Ral 9003	2,235.00
	CELES-XL-OAK	17 7/8"	26 3/8"	27 1/2"	21 lbs.	Side table constructed of painted steel legs with laminated matte oak tabletop for indoor use only.	Matte Grey Beige Ral 1019, Mustard Gloss Ral 1012, Satin Black Ral 9011 or Matte White Ral 9003 with Matte Oak tabletop	2,165.00

# LAURA

## FINISH COLORS



White



LINE ART	MODEL	H	W	D	WEIGHT	DESCRIPTION	COLOR/FINISH	LIST PRICE
	LAURA	19 3/4"	27 5/8"	round	36 lbs.	Round table with planter or storage space in base. Planter area is 9 1/2" high x15 3/4" round. Indoor only.	Matte White Ral 9003	2,625.00

## ADDITIONAL NOTES

Ships via UPS

Sample chips available.

# MILL

## BASE FINISH COLORS



Black



White

## TOP FINISH COLORS



Black Laquered  
MDF





White Laquered  
MDF

## ADDITIONAL NOTES

Ships via common carrier.

Sample chips available.



LINE ART	MODEL	H	W	D	WEIGHT	DESCRIPTION	COLOR/FINISH	LIST PRICE
	MILL-G	19 3/4"	17 3/4"	round	21 lbs.	Table with painted steel Y base and round top in tempered glass. Top is 17 3/4" round.	Base in Satin Black Ral 9011 or Matte White Ral 9003 finish. Top in transparent tempered glass.	1,275.00
	MILL-GC	19 3/4"	17 3/4"	round	21 lbs.	Table with chromed steel Y base and round top in tempered glass. Top is 17 3/4" round.	Chrome Base with top in transparent tempered glass	1,345.00
	MILL-M	19 7/8"	17 3/4"	round	18 lbs.	Table with painted steel Y base and round top in lacquered MDF finish. Top is 17 3/4" round.	Matte White Ral 9003 base with White MDF top or Satin Black Ral9011 base with Black MDF top	1,395.00

# OXI BISTROT

## FRAME FINISH COLORS



White RAL 9002



Black RAL 9004

## TOP FINISH COLORS



White RAL 9002



Black RAL 9004

## ADDITIONAL NOTES

Ships via common carrier.

Oxi Bistrot tables are suitable for indoor and outdoor use.



LINE ART	MODEL	H	W	D	WEIGHT	DESCRIPTION	COLOR/FINISH	LIST PRICE
	OXI-10	29 1/8"	23 5/8"	round	38 lbs.	Chair height table with cross shaped central base in painted finish. Round top in high pressure phenolic finish. Adjustable glides. Includes hanging bracket for purse/bags.	Post and base in Black Ral 9004 or Grey White Ral 9002 painted finish. Top in Black or White high pressure phenolic with black edge band	1,975.00
	OXI-20	29 1/8"	31 1/2"	round	51 lbs.	Chair height table with cross shaped central base in painted finish. Round top in high pressure phenolic finish. Adjustable glides. Includes hanging bracket for purse/bags.	Post and base in Black Ral 9004 or Grey White Ral 9002 painted finish. Top in Black or White high pressure phenolic with black edge band	2,195.00
	OXI-30	29 1/8"	27 9/16"	27 9/16"	51 lbs.	Chair height table with cross shaped central base in painted finish. Square top in high pressure phenolic finish. Adjustable glides. Includes hanging bracket for purse/bags.	Post and base in Black Ral 9004 or Grey White Ral 9002 painted finish. Top in Black or White high pressure phenolic with black edge band	2,085.00
	OXI-40	43 3/8"	23 5/8"	round	49 lbs.	Bar height table with cross shaped central base in painted finish. Round top in high pressure phenolic finish. Adjustable glides. Includes hanging bracket for purse/bags.	Post and base in Black Ral 9004 or Grey White Ral 9002 painted finish. Top in Black or White high pressure phenolic with black edge band	1,975.00

# OUTDOOR SEATING

HOME → PRODUCTS → OUTDOOR SEATING

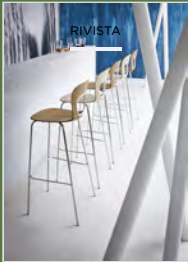
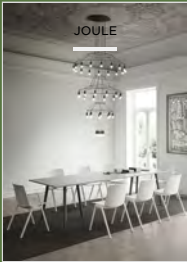
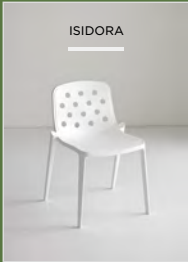

# CALMA

## SEAT FINISH COLORS



Black



Green



White

## SPECIAL ORDER SEAT FINISH COLORS



Beige



Dark Blue



Orange



Pearl Grey



Red

## FRAME FINISH COLORS



White

## ADDITIONAL NOTES

Ships via common carrier.



Seat height is 30 5/16"

Calma meets or exceeds the minimum requirements per ANSI/BIFMA X5.1-2011 office chairs.

Sample chips available.

Sold in cartons of 4 only.



LINE ART	MODEL	H	W	D	WEIGHT	DESCRIPTION	COLOR/FINISH	LIST PRICE
	CALMA	35"	14 1/2"	14 3/16"	44 lbs.	Bar height stool made of technopolymer seat with painted frame. Stackable 5 high for storage. Suitable for indoor and outdoor use. Assembly required. Sold in cartons of 4 only.	Frame in White, seat in Black, White, Green	1,695.00 <b>Sold in cartons of 4 only.</b>
	CALMA-SO	35"	14 1/2"	14 3/16"	44 lbs.	Bar height stool made of technopolymer seat with painted frame. Stackable 5 high for storage. Suitable for indoor and outdoor use. Assembly required. Sold in cartons of 4 only.	Beige, Red, Dark Blue, Pearl Grey and Orange as special order.	1,845.00 <b>Sold in cartons of 4 only.</b>

# ISIDORA

## FINISH COLORS



Pearl Grey



White

## SPECIAL ORDER FINISH COLORS



Lobster



Sage Green



Sand



Turtledove

## ADDITIONAL NOTES

Ships via common carrier.



Seat height is 17 1/2".

Sample chips available.

Sold in cartons of 4 only.

Isidora chairs are not BIFMA certified. Isidora weight limit is 291 lbs



LINE ART	MODEL	H	W	D	WEIGHT	DESCRIPTION	COLOR/FINISH	LIST PRICE
	ISI-CHR	34 1/4"	20 15/32"	20 15/32"	36 lbs.	Chair made of technopolymer. Stackable 6 high for storage. Suitable for indoor and outdoor use. Sold in cartons of 4 only.	White or Pearl Grey	1,315.00 <b>Sold in cartons of 4 only.</b>
	ISI-CHR-SO	34 1/4"	20 15/32"	20 15/32"	36 lbs.	Chair made of technopolymer. Stackable 6 high for storage. Suitable for indoor and outdoor use. Sold in cartons of 4 only.	Sage Green, Turtledove, Sand or Lobster	1,425.00 <b>Sold in cartons of 4 only.</b>

# ISIDORO

## FINISH COLORS



Pearl Grey



White

## SPECIAL ORDER FINISH COLORS



Bordeaux



Dark Grey



Sage Green



Sand



Turtledove

## ADDITIONAL NOTES

Ships via common carrier.



Seat height is 30 1/8".

Isidoro meets or exceeds the minimum requirements per ANSI/BIFMA X5.1-2011 office chairs.

Sample chips available.

Sold in cartons of 4 only.



LINE ART	MODEL	H	W	D	WEIGHT	DESCRIPTION	COLOR/FINISH	LIST PRICE
	ISI-STL	38 3/16"	18 29/32"	18 1/8"	45 lbs.	Bar height stool made of technopolymer with co-injected metal frame. Stackable 6 high for storage. Suitable for indoor and outdoor use. Sold in Cartons of 4 only.	White or Pearl Grey	1,535.00 <b>Sold in cartons of 4 only.</b>
	ISI-STL-SO	38 3/16"	18 29/32"	18 1/8"	45 lbs.	Bar height stool made of technopolymer with co-injected metal frame. Stackable 6 high for storage. Suitable for indoor and outdoor use. Sold in Cartons of 4 only.	Sage Green, Bordeaux, Turtledove, Sand or Dark Grey	1,645.00 <b>Sold in cartons of 4 only.</b>



# JOULE

## FINISH COLORS



White



Black



Pearl Grey

## SPECIAL ORDER FINISH COLORS



Lobster



Sand



Pale Blue

## ADDITIONAL NOTES

Ships via common carrier.

Seat height for Joule is 18 inches from floor to seat pan.



Seat height is 17 3/8".

JOULE meets or exceeds the minimum requirements per ANSI/BIFMA X5.1-2017 office chairs.

Sample chips available.

Sold in sets of 4 only.



LINE ART	MODEL	H	W	D	WEIGHT	DESCRIPTION	COLOR/FINISH	LIST PRICE
	JOULE	31 1/4"	21"	20"	55 lbs.	Techno polymer chair with coinjected metal frame. Stackable 8 units high. Ships assembled. Suitable for indoor and outdoor use. Sold in Cartons of 4 only.	White, Black or Pearl Grey	1,785.00 <b>Sold in cartons of 4 only.</b>
	JOULE-SO	31 1/4"	21"	20"	55 lbs.	Techno polymer chair with coinjected metal frame. Stackable 8 units high. Ships assembled. Suitable for indoor and outdoor use. Sold in Cartons of 4 only.	Lobster, Sand or Pale Blue	1,895.00 <b>Sold in cartons of 4 only.</b>

# LUCIDO

## FINISH COLORS



White

## SPECIAL ORDER FINISH COLORS



Beige



Black



Dark Blue



Dark Brown



Light Brown



Green



Mustard



Pearl Grey



Red

## ADDITIONAL NOTES

Ships via common carrier.



Seat height is 18".

Lucido meets or exceeds the minimum requirements per ANSI/BIFMA X5.1-2011 office chairs.

Sample chips available.

Sold in cartons of 4 only.



LINE ART	MODEL	H	W	D	WEIGHT	DESCRIPTION	COLOR/FINISH	LIST PRICE
	LUCIDO	32 5/16"	18 1/4"	19 11/16"	42 lbs.	Techno polymer chair with co-injected metal frame. Stackable 5 units high. Ships assembled. Suitable for indoor and outdoor use. Sold in Cartons of 4 only.	White	1,315.00 <b>Sold in cartons of 4 only.</b>
	LUCIDO-SO	32 5/16"	18 1/4"	19 11/16"	42 lbs.	Techno polymer chair with co-injected metal frame. Stackable 5 units high. Ships assembled. Suitable for indoor and outdoor use. Sold in Cartons of 4 only.	Beige, Red, Dark Blue, Black, Dark Brown, Pearl Grey, Green, Mustard or Light Brown as special order.	1,425.00 <b>Sold in cartons of 4 only.</b>

# OM BASIC

## FINISH COLORS



Grey RAL 7022



White RAL 9003

## ADDITIONAL NOTES

Ships via common carrier.

Seat height is 16 1/2".

OM Basic meets or exceeds the minimum requirements per ANSI/BIFMA X5.1-2011 office chairs.

Sample chips available.



LINE ART	MODEL	H	W	D	WEIGHT	DESCRIPTION	COLOR/FINISH	LIST PRICE
	OMB-10	29 1/2"	22 7/16"	21 1/4"	25 lbs.	Polyethylene armchair for indoor or outdoor use, 100% recyclable. Can be filled with pea gravel and a plug for outdoor use. OM Basic meets or exceeds the minimum requirements per ANSI/BIFMA X5.1-2011 for Office Chairs and has a weight capacity of 252lbs.	White Ral 9003 or Grey Ral 7022	1,095.00
	FLO-011					Plug for OMB-10 for use when filling OMB-10 with pea gravel. (must be ordered separately. 2 plugs required per chair.)		0.00

# RIVISTA

## STANDARD SEAT & INSERT FINISH COLORS



Black Seat White Insert



White Seat Grey Insert

## SPECIAL ORDER SEAT & INSERT FINISH COLORS



Red Seat White Insert



Turtledove Seat White Insert

## FRAME FINISH COLORS



White

## ADDITIONAL NOTES

Ships via common carrier.



Seat height is 30 3/4"

Rivista meets or exceeds the minimum requirements per ANSI/BIFMA X5.1-2011 office chairs.

Sample chips available.

Sold in cartons of 4 only.



LINE ART	MODEL	H	W	D	WEIGHT	DESCRIPTION	COLOR/FINISH	LIST PRICE
	RIVISTA-STL	47 11/16"	17 3/4"	17 3/4"	49 lbs.	Bar height stool made of techno polymer seat with painted frame. Stackable 4 high for storage. Suitable for indoor and outdoor use. Assembly required. Sold in Cartons of 4 only.	Frame in White, seat in White with Grey insert or Black with White insert	1,975.00 <b>Sold in cartons of 4 only.</b>
	RIVISTA-STL-SO	47 11/16"	17 3/4"	17 3/4"	44 lbs.	Bar height stool made of techno polymer seat with painted frame. Stackable 4 high for storage. Suitable for indoor and outdoor use. Assembly required. Sold in Cartons of 4 only.	Red with White insert, Turtle dove with White insert as special order	2,195.00 <b>Sold in cartons of 4 only.</b>

# RIVISTA CHAIR

## STANDARD SEAT & INSERT FINISH COLORS



Black Seat White Insert



White Seat Grey Insert

## SPECIAL ORDER SEAT & INSERT FINISH COLORS



Red Seat White Insert



Turtledove Seat White Insert

## FRAME FINISH COLORS



White

## ADDITIONAL NOTES

Ships via common carrier.



Seat height is 17 3/4"

Rivista meets or exceeds the minimum requirements per ANSI/BIFMA X5.1-2011 office chairs.

Sample chips available.

Sold in cartons of 4 only.



LINE ART	MODEL	H	W	D	WEIGHT	DESCRIPTION	COLOR/FINISH	LIST PRICE
	RIVISTA-CHR	31 29/32"	16 15/16"	19 11/16"	44 lbs.	Chair made of techno polymer seat with painted frame. Seat height is 17 3/4". Stackable 5 high for storage. Suitable for indoor and outdoor use. Sold in Cartons of 4 only.	Frame in White, seat in White with Grey insert or Black with White insert	1,535.00 <b>Sold in cartons of 4 only.</b>
	RIVISTA-CHR-SO	31 29/32"	16 15/16"	19 11/16"	44 lbs.	Chair made of technopolymer seat with painted frame. Seat height is 17 3/4". Stackable 5 high for storage. Suitable for indoor and outdoor use. Sold in Cartons of 4 only.	Frame in White, seat in Red with White insert or Turtle Dove with White insert. Available as special order.	1,645.00 <b>Sold in cartons of 4 only.</b>

# STILLA

## FINISH COLORS



Red



Sand



White

## SPECIAL ORDER FINISH COLORS



Cement Grey



Cipria



Light Teal



Mustard

## ADDITIONAL NOTES

Ships via common carrier.



Seat height is 17 3/4".

Stilla meets or exceeds the minimum requirements per ANSI/BIFMA X5.1-2011 office chairs.

Sample chips available.

Sold in cartons of 4 only.



LINE ART	MODEL	H	W	D	WEIGHT	DESCRIPTION	COLOR/FINISH	LIST PRICE
	STIL-CHR	30 3/4"	21"	20 1/4"	36 lbs.	Polypropylene and fiber glass chair with cut out for rainwater drain off. Stackable 6 units high for storage. Ships assembled. Suitable for indoor and outdoor use. Sold in Cartons of 4 only.	White, Sand or Red	1,115.00 <b>Sold in cartons of 4 only.</b>
	STIL-CHR-SO	30 3/4"	21"	20 1/4"	36 lbs.	Polypropylene and fiber glass chair with cut out for rain water drain off. Stackable 6 units high for storage. Ships assembled. Suitable for indoor and outdoor use. Sold in Cartons of 4 only.	Cement Grey, Mustard, Cipria and Light Teal as special order.	1,260.00 <b>Sold in cartons of 4 only.</b>

# VACANZA

## FINISH COLORS



Black



Pistachio



White

## SPECIAL ORDER FINISH COLORS



Red



Sand

## ADDITIONAL NOTES



Ships via common carrier.

Vacanza meets or exceeds the minimum requirements per ANSI/BIFMA X5.1-2011 office chairs.

Sample chips available.

Sold in cartons of 4 only.



LINE ART	MODEL	H	W	D	WEIGHT	DESCRIPTION	COLOR/FINISH	LIST PRICE
	VACANZA	32"	20 1/4"	22"	38 lbs.	Polypropylene and fiberglass shell with anodized aluminum frame and UV resistant colors. Chair is provided with cut out for rain water drain off. Seat height is 17 1/2. Stackable 7 units high for storage. Suitable for indoor and outdoor use. Sold in Cartons of 4 only.	Pistachio, White or Black	995.00 <b>Sold in cartons of 4 only.</b>
	VACANZA-SO	32"	20 1/4"	22"	38 lbs.	Polypropylene and fiber glass shell with anodized aluminum frame and UV resistant colors. Chair is provided with cutout for rain water drain off. Seat height is 17 1/2. Stackable 7 units high for storage. Ships unassembled. Suitable for indoor and outdoor use. Sold in Cartons of 4 only.	Sand or Red as special order.	1,125.00 <b>Sold in cartons of 4 only.</b>

# OUTDOOR TABLES

---

HOME → PRODUCTS → OUTDOOR TABLES

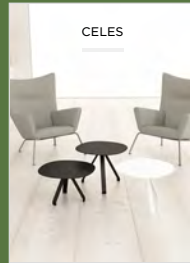



# CELES

## FINISH COLORS



Black



White



Mustard







Grey Beige

## ADDITIONAL NOTES

Ships via UPS

Sample chips available.



LINE ART	MODEL	H	W	D	WEIGHT	DESCRIPTION	COLOR/FINISH	LIST PRICE
	CELES-S	11 11/16"	19 1/2"	18 3/4"	13 lbs.	Side table constructed of painted aluminum for indoor and outdoor use.	Matte Grey Beige Ral 1019, Mustard Gloss Ral 1012, Satin Black Ral 9011 or Matte White Ral 9003	1,895.00
	CELES-M	13 5/8"	19 1/2"	18 3/4"	13 lbs.	Side table constructed of painted aluminum for indoor and outdoor use.	Matte Grey Beige Ral 1019, Mustard Gloss Ral 1012, Satin Black Ral 9011 or Matte White Ral 9003	1,895.00
	CELES-L	15 5/8"	19 1/2"	18 3/4"	14 lbs.	Side table constructed of painted aluminum for indoor and outdoor use.	Matte Grey Beige Ral 1019, Mustard Gloss Ral 1012, Satin Black Ral 9011 or Matte White Ral 9003	1,945.00
	CELES-XL	17 7/8"	26 3/8"	27 1/2"	21 lbs.	Side table constructed of painted aluminum for indoor and outdoor use.	Matte Grey Beige Ral 1019, Mustard Gloss Ral 1012, Satin Black Ral 9011 or Matte White Ral 9003	2,235.00

# OXI BISTROT

## FRAME FINISH COLORS



White RAL 9002



Black RAL 9004

## TOP FINISH COLORS



White RAL 9002



Black RAL 9004

## ADDITIONAL NOTES

Ships via common carrier.

Oxi Bistrot tables are suitable for indoor and outdoor use.





LINE ART	MODEL	H	W	D	WEIGHT	DESCRIPTION	COLOR/FINISH	LIST PRICE
	OXI-10	29 1/8"	23 5/8"	round	38 lbs.	Chair height table with cross shaped central base in painted finish. Round top in high pressure phenolic finish. Adjustable glides. Includes hanging bracket for purse/bags.	Post and base in Black Ral 9004 or Grey White Ral 9002 painted finish. Top in Black or White high pressure phenolic with black edge band	1,975.00
	OXI-20	29 1/8"	31 1/2"	round	51 lbs.	Chair height table with cross shaped central base in painted finish. Round top in high pressure phenolic finish. Adjustable glides. Includes hanging bracket for purse/bags.	Post and base in Black Ral 9004 or Grey White Ral 9002 painted finish. Top in Black or White high pressure phenolic with black edge band	2,195.00
	OXI-30	29 1/8"	27 9/16"	27 9/16"	51 lbs.	Chair height table with cross shaped central base in painted finish. Square top in high pressure phenolic finish. Adjustable glides. Includes hanging bracket for purse/bags.	Post and base in Black Ral 9004 or Grey White Ral 9002 painted finish. Top in Black or White high pressure phenolic with black edge band	2,085.00
	OXI-40	43 3/8"	23 5/8"	round	49 lbs.	Bar height table with cross shaped central base in painted finish. Round top in high pressure phenolic finish. Adjustable glides. Includes hanging bracket for purse/bags.	Post and base in Black Ral 9004 or Grey White Ral 9002 painted finish. Top in Black or White high pressure phenolic with black edge band	1,975.00

## ADDITIONAL NOTES

Ships via common carrier.

Sample chips available.



LINE ART	MODEL	H	W	D	WEIGHT	DESCRIPTION	COLOR/FINISH	LIST PRICE
	SIM-01	29 3/4"	31 1/2"	31 1/2"	42 lbs.	Outdoor square chair height table with painted steel top and legs	Top in White, Black or Grey, legs in White, Black or Grey	995.00
	SIM-02	39 5/16"	31 1/2"	31 1/2"	42 lbs.	Outdoor square stool height table with painted steel top and legs	Top in White, Black or Grey, base in White, Black or Grey	1,095.00
	SIM-03	29 3/4"	47 1/4"	31 1/2"	50 lbs.	Outdoor rectangular chair height table with painted steel top and legs	Top in White, Black or Grey, base in White, Black or Grey	1,345.00

# STEP

## FRAME & LEGS FINISH COLORS



Green



Pearl Grey



White

## SPECIAL ORDER FRAME & LEGS FINISH COLORS



Light Brown



Orange



Red



Teal



Sand



Black

## TOP FINISH COLORS



White

## SPECIAL ORDER TOP FINISH COLORS



Black



Pearl Grey

## ADDITIONAL NOTES





Ships via common carrier.





Step tables include 6 hooks on under-side to hold purses/bags.

Assembly required. Indoor and outdoor use.

Sample chips available.



LINE ART	MODEL	H	W	D	WEIGHT	DESCRIPTION	COLOR/FINISH	LIST PRICE
	STEP-01	43 1/2"	47 1/4"	19 3/4"	56 lbs.	High table constructed of co-injected metal frame with techno polymer high pressure phenolic top with black edge band. Painted frame with satin aluminum foot bar.	Top in White, frame/legs in White, Pearl Grey or Green	1,525.00
	STEP-01-SO	43 1/2"	47 1/4"	19 3/4"	56 lbs.	High table constructed of co-injected metal frame with techno polymer high pressure phenolic top with black edge band. Painted frame with satin aluminum foot bar.	Table top in Black or Pearl Grey, frame/legs in Red, Brown, Orange, Black, Sand or Teal as special order	1,645.00
	STEP-02	43 1/2"	47 1/4"	27 3/4"	58 lbs.	High table constructed of co-injected metal frame with techno polymer high pressure phenolic top with black edge band. Painted frame with satin aluminum foot bar.	Top in White, frame/legs in White, Pearl Grey or Green	1,695.00
	STEP-02-SO	43 1/2"	47 1/4"	27 3/4"	58 lbs.	High table constructed of co-injected metal frame with techno polymer high pressure phenolic top with black edge band. Painted frame with satin aluminum foot bar.	Table top in Black or Pearl Grey, frame/legs in Red, Brown, Orange, Black, Sand or Teal as special order	1,845.00

	STEP-03	43 1/2"	70 7/8"	19 11/16"	89 lbs.	High table constructed of co-injected metal frame with techno polymer high pressure phenolic top with black edge band. Painted frame with satin aluminum foot bar.	Top in White, frame/legs in White, Pearl Grey or Green.	1,555.00
	STEP-03-SO	43 1/2"	70 7/8"	19 11/16"	89 lbs.	High table constructed of co-injected metal frame with techno polymer high pressure phenolic top with black edge band. Painted frame with satin aluminum foot bar.	Table top in Black or Pearl Grey, frame/legs in Red, Brown, Orange, Black, Sand or Teal as special order	1,865.00
	STEP-04	43 1/2"	70 7/8"	27 3/16"	104 lbs.	High table constructed of co-injected metal frame with techno polymer high pressure phenolic top with black edge band. Painted frame with satin aluminum foot bar.	Top in White, frame/legs in White, Pearl Grey or Green.	1,635.00
	STEP-04-SO	43 1/2"	70 7/8"	27 3/16"	104 lbs.	High table constructed of co-injected metal frame with techno polymer high pressure phenolic top with black edge band. Painted frame with satin aluminum foot bar.	Table top in Black or Pearl Grey, frame/legs in Red, Brown, Orange, Black, Sand or Teal as special order	1,925.00

# STILLA

## FINISH COLORS



Light Grey



White

## SPECIAL ORDER FINISH COLORS







Sand

## ADDITIONAL NOTES

Ships via common carrier.

Sample chips available.



LINE ART	MODEL	H	W	D	WEIGHT	DESCRIPTION	COLOR/FINISH	LIST PRICE
	STILTBL-R	28 5/16"	32 1/2"	round	29 lbs.	Fiberglass filled polypropylene table with round top and 4 legs with rubber feet. Six tables can be stacked vertically for storage. Ships unassembled. Suitable for indoor and outdoor use.	White or Light Grey.	825.00
	STILTBL-R-SO	28 5/16"	32 1/2"	round	29 lbs.	Fiberglass filled polypropylene table with round top and 4 legs with rubber feet. Six tables can be stacked vertically for storage. Ships unassembled. Suitable for indoor and outdoor use.	Sand.	920.00
	STILTBL-S	28 7/16"	28 3/4"	28 3/4"	29 lbs.	Fiberglass filled polypropylene table with square top and 4 legs with rubber feet. Six tables can be stacked vertically for storage. Ships unassembled. Suitable for indoor and outdoor use.	White or Light Grey.	875.00
	STILTBL-S-SO	28 7/16"	28 3/4"	28 3/4"	29 lbs.	Fiberglass filled polypropylene table with square top and 4 legs with rubber feet. Six tables can be stacked vertically for storage. Ships unassembled. Suitable for indoor and outdoor use.	Sand.	975.00

# OUTDOOR ASHTRAYS

---

HOME → PRODUCTS → OUTDOOR ASHTRAYS



## FINISH COLORS



Black



White





## ADDITIONAL NOTES

Ships via UPS

Suitable for outdoor use.

Includes tool needed to remove lid. Slot for disposal is 1 15/16" long by 2 1/8" wide.

Sample chips available.

LINE ART	MODEL	H	W	D	WEIGHT	DESCRIPTION	COLOR/FINISH	LIST PRICE
	FUM	39 11/16"	9 5/8"	9 5/8"	13 lbs.	Standing ashtray. Can be secured to the ground.	Matte White Ral 9003 or Satin Black Ral 9011	1,225.00
	FUM-W	19 15/16"	2 1/8"	3 3/4"	4 lbs.	Wall mounted ashtray.	Matte White RAL 9003 or Satin Black RAL 9011	850.00



# RIGA

## BODY FINISH COLORS



Stainless Steel RAL 9006

## ADDITIONAL NOTES

Ships via Common Carrier  
Riga Stainless Steel units are suitable for outdoor use under cover.  
Sample chips available.



LINE ART	MODEL	H	W	D	WEIGHT	DESCRIPTION	COLOR/FINISH	LIST PRICE
	RIGA-ASH	27 15/16"	9 13/16"	9 13/16"	15 lbs.	Waste bin with front opening, integrated bag ring and ashtray. Capacity 7.9 gallons.	Stainless Steel with Satin Silver Aluminum top.	1,155.00





# VESUVIO

## ADDITIONAL NOTES

Wall mounted units VEM/VEM-C ship via UPS; freestanding and ground fixed units ship via common carrier.

VEF is the only model that can be secured to the ground.



LINE ART	MODEL	H	W	D	WEIGHT	DESCRIPTION	COLOR/FINISH	LIST PRICE
	VEF	44 5/16"	9 13/16"	7 11/16"	28 lbs.	Ground /floor fixed ashtray	Black or Silver	1,160.00
	VES	44 5/16"	9 13/16"	12"	28 lbs.	Freestanding ashtray	Black or Silver	1,315.00
	VESR	44 5/16"	15 3/4"	15 3/4"	43 lbs.	Freestanding ashtray with large base	Black or Silver	1,350.00
	VEM	29 1/8"	9 13/16"	4 5/16"	15 lbs.	Wall mounted ashtray	Black or Silver	1,035.00

# BROCHURE & LEAFLET HOLDER

---

[HOME](#) → [PRODUCTS](#) → [BROCHURE & LEAFLET HOLDER](#)













# DACAPO









## ADDITIONAL NOTES

Ships via FedEx

Dacapo is available in pre-configured sets or purchase components (rail and polystyrene holders) to meet your requirements.



LINE ART	MODEL	H	W	D	WEIGHT	DESCRIPTION	COLOR/FINISH	LIST PRICE
	DC50-2A4	10 1/2"	19 11/16"	5 1/2"	3 lbs.	Wall mounted rail with two A4 sized polystyrene brochure holders (for brochures up to 8 1/2" W x 11 11/16" H).	Silver Anodized Aluminum rail with clear pockets	220.00
	DC50-3A5	7 7/8"	19 11/16"	4 3/8"	3 lbs.	Wall mounted rail with three A5 sized polystyrene leaflet holders (for leaflets up to 5 13/16" W x 8 1/4" H).	Silver Anodized Aluminum rail with clear pockets	280.00
	DC50-4A6	5 1/4"	19 11/16"	3 1/4"	2 lbs.	Wall mounted rail with four A6 sized polystyrene leaflet holders (for leaflets up to 4 1/8" W x 5 13/16" H).	Silver Anodized Aluminum rail with clear pockets	290.00
	DC10-4A4	10 1/2"	39 3/8"	5 1/2"	5 lbs.	Wall mounted rail with four A4 sized polystyrene brochure holders (for brochures up to 8 1/2" W x 11 11/16" H).	Silver Anodized Aluminum rail with clear pockets	435.00
	DC10-6A5	7 7/8"	39 3/8"	4 3/8"	5 lbs.	Wall mounted rail with six A5 sized polystyrene leaflet holders (for leaflets up to 5 13/16" W x 8 1/4" H).	Silver Anodized Aluminum rail with clear pockets	545.00
	DC10-8A6	5 1/4"	39 3/8"	3 1/4"	4 lbs.	Wall mounted rail with eight A6 sized polystyrene leaflet holders (for leaflets up to 4 1/8" W x 5 13/16" H).	Silver Anodized Aluminum rail with clear pockets	610.00
	DC15-6A4	10 1/2"	59 1/16"	5 1/2"	9 lbs.	Wall mounted rail with six A4 sized polystyrene brochure holders (for brochures up to 8 1/2" W x 11 11/16" H).	Silver Anodized Aluminum rail with clear pockets	730.00
	DC15-9A5	7 7/8"	59 1/16"	4 3/8"	8 lbs.	Wall mounted rail with nine A5 sized polystyrene leaflet holders (for leaflets up to 5 13/16" W x 8 1/4" H).	Silver Anodized Aluminum rail with clear pockets	885.00
	DC15-12A6	5 1/4"	59 1/16"	3 1/4"	6 lbs.	Wall mounted rail with twelve A6 sized polystyrene leaflet holders (for leaflets up to 4 1/8" W x 5 13/16" H).	Silver Anodized Aluminum rail with clear pockets	940.00
	DC20-8A4	10 1/2"	78 3/4"	5 1/2"	12 lbs.	Wall mounted rail with eight A4 sized polystyrene brochure holders (for brochures up to 8 1/2" W x 11 11/16" H). Rail in two 39 3/8" sections.	Silver Anodized Aluminum rail with clear pockets	940.00

	DC20-12A5	7 7/8"	78 3/4"	4 3/8"	20 lbs.	Wall mounted rail with twelve A5 sized polystyrene leaflet holders (for leaflets up to 5 13/16" W x 8 1/4" H). Rail in two 39 3/8" sections.	Silver Anodized Aluminum rail with clear pockets	1,150.00
	DC20-16A6	5 1/4"	78 3/4"	3 1/4"	12 lbs.	Wall mounted rail with sixteen A6 sized polystyrene leaflet holders (for leaflets up to 4 1/8" W x 5 13/16" H). Rail in two 39 3/8" sections.	Silver Anodized Aluminum rail with clear pockets	1,220.00
	DCR-500	19 11/16"			2 lbs.	Wall mounted rail only 19 11/16" long	Silver Anodized Aluminum	75.00
	DCR-1000	39 3/8"			3 lbs.	Wall mounted rail only 39 3/8" long	Silver Anodized Aluminum	115.00
	DCR-1500	59 1/16"			4 lbs.	Wall mounted rail only 59 1/16" long	Silver Anodized Aluminum	165.00
	DCR-2000	78 3/4"			6 lbs.	Wall mounted rail only 78 3/4" long	Silver Anodized Aluminum	265.00
	DCT-A6	5 7/8"	4 5/8"	2 1/2"	1/2 lb.	A6 sized polystyrene leaflet holder only (for leaflets up to 4 1/8" W x 5 13/16" H). Pocket is 1 5/8" deep.	Clear Polystyrene	59.00
	DCT-A5	8"	6 1/2"	2 3/4"	1/2 lb.	A5 sized polystyrene leaflet holder only (for leaflets up to 5 13/16" W x 8 1/4" H). Pocket is 1 5/8" deep.	Clear Polystyrene	71.00
	DCT-A4	11 3/16"	9"	3 1/4"	1/2 lb.	A4 sized polystyrene brochure holder only (for brochures up to 8 1/2" W x 11 11/16" H). Pocket is 1 5/8" deep.	Clear Polystyrene	89.00











# DACAPO | POINT

## ADDITIONAL NOTES

Ships via common carrier.

Dacapo Ipoint is available in pre-configured sets or purchase components (free standing display and polystyrene holders) to meet your requirements.



LINE ART	MODEL	H	W	D	WEIGHT	DESCRIPTION	COLOR/FINISH	LIST PRICE
	DACI-5A4	68 1/8"	13 1/16"	13 1/16"	40 lbs.	Free standing single sided brochure display with five A4 sized polystyrene brochure holders (for brochures up to 8 1/2" W x 11 11/16" H).	Black display with Silver frame and clear pockets	1,665.00
	DACI-10A4	68 1/8"	13 1/16"	13 1/16"	47 lbs.	Free standing double sided brochure display with ten A4 sized polystyrene brochure holders (for brochures up to 8 1/2" W x 11 11/16" H).	Black display with Silver frame and clear pockets	2,075.00
	DACI-5A5	68 1/8"	13 1/16"	13 1/16"	39 lbs.	Free standing single sided leaflet display with five A5 sized polystyrene leaflet holders (for leaflets up to 5 13/16" W x 8 1/4" H).	Black display with Silver frame and clear pockets	1,520.00
	DACI-10A5	68 1/8"	13 1/16"	13 1/16"	43 lbs.	Free standing double sided leaflet display with ten A5 sized polystyrene leaflet holders (for leaflets up to 5 13/16" W x 8 1/4" H).	Black display with Silver frame and clear pockets	1,920.00
	DACI-9A6	68 1/8"	13 1/16"	13 1/16"	39 lbs.	Free standing single sided leaflet display with nine A6 sized polystyrene leaflet holders (for leaflets up to 4 1/8" W x 5 13/16" H).	Black display with Silver frame and clear pockets	1,725.00
	DACI-18A6	68 1/8"	13 1/16"	13 1/16"	42 lbs.	Free standing double sided leaflet display with eighteen A6 sized polystyrene leaflet holders (for leaflets up to 4 1/8" W x 5 13/16" H).	Black display with Silver frame and clear pockets	2,170.00
	DACI-PR	68 1/8"	13 1/16"	13 1/16"	35 lbs.	Free standing double sided display with 9 slots on each side. Compatible with A4/A5/A6 sized polystyrene holders.	Black display with Silver frame	1,120.00
	DCT-A6	5 7/8"	4 5/8"	2 1/2"	1/2 lb.	A6 sized polystyrene leaflet holder only (for leaflets up to 4 1/8" W x 5 13/16" H). Pocket is 1 5/8" deep.	Clear Polystyrene	59.00
	DCT-A5	8"	6 1/2"	2 3/4"	1/2 lb.	A5 sized polystyrene leaflet holder only (for leaflets up to 5 13/16" W x 8 1/4" H). Pocket is 1 5/8" deep.	Clear Polystyrene	71.00
	DCT-A4	11 3/16"	9"	3 1/4"	1/2 lb.	A4 sized polystyrene brochure holder only (for brochures up to 8 1/2" W x 11 11/16" H). Pocket is 1 5/8" deep.	Clear Polystyrene	89.00

# UMBRELLA STANDS

HOME → PRODUCTS → UMBRELLA STANDS

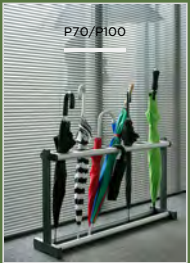
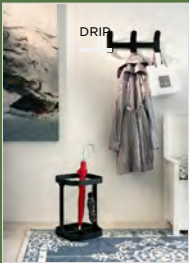

# DRIP

## ADDITIONAL NOTES

Ships via UPS

Sample chips available.



LINE ART	MODEL	H	W	D	WEIGHT	DESCRIPTION	COLOR/FINISH	LIST PRICE
	DRIP	17 11/16"	12 3/8"	12 3/8"	14 lbs.	Umbrella stand in epoxy coated steel with removable drip tray.	Black 9011, Metallic Grey 9006 or White 9010	1,590.00



# DROP-IN

## LARGE BIN FINISH COLORS



Textured Black



Textured Forge Grey



Textured White

## INTEGRATED SMALL BIN FINISH COLORS



Textured Black



Textured Forge Grey



Textured White



Mustard





Grey Beige

## ADDITIONAL NOTES

Ships via UPS

Sample chips available.



LINE ART	MODEL	H	W	D	WEIGHT	DESCRIPTION	COLOR/FINISH	LIST PRICE
	DROP IN-01	18 7/8"	15 3/8"	7 1/16"	15 lbs.	Umbrella stand with removable drip tray.	Textured White, Textured Black Ral 9011 or Textured Forge Grey.	615.00
	DROP IN-02	19 15/16"	16 3/8"	7 1/16"	18 lbs.	Umbrella stand for long umbrellas with integrated bin for shorter umbrellas. Removable drip tray.	Textured White, Textured Black Ral 9011 or Textured Forge Grey main bin. Integrated bin available in Textured White, Textured Black, Textured Forge Grey, Matte Grey Beige Ral 1019 or Mustard Gloss RAL 1012.	975.00

# FORREIN

## FINISH COLORS



Textured Black



Textured Forge Grey



Textured White

## ADDITIONAL NOTES

Ships via UPS

Sample chips available.





LINE ART	MODEL	H	W	D	WEIGHT	DESCRIPTION	COLOR/FINISH	LIST PRICE
	FORREIN	19 13/16"	12 13/16"	9 7/16"	15 lbs.	Umbrella stand with polyethylene base.	Textured White, Textured Black Ral 9011 or Textured Forge Grey	585.00

# P70/P100

## ADDITIONAL NOTES

Ships via UPS



LINE ART	MODEL	H	W	D	WEIGHT	DESCRIPTION	COLOR/FINISH	LIST PRICE
	P 70	20 7/8"	27 9/16"	8 11/16"	14 lbs.	Umbrella stand for up to 15 umbrellas	Dark Grey w/Satin Aluminum	867.00
	P 100	20 7/8"	39 3/8"	8 11/16"	16 lbs.	Umbrella stand for up to 20 umbrellas	Dark Grey w/Satin Aluminum	893.00

# PLATEA

## FRAME FINISH COLORS



Chrome

## DRIP TRAY FINISH COLORS



Aluminum RAL 9006

## ADDITIONAL NOTES

Ships via UPS



LINE ART	MODEL	H	W	D	WEIGHT	DESCRIPTION	COLOR/FINISH	LIST PRICE
	PLATEA	19 5/16"	11 7/16"	round	8 lbs.	Umbrella stand for all sizes of umbrellas. Includes easily removable drip tray.	Chrome with drip tray in Aluminum Ral 9006.	745.00

## BODY FINISH COLORS



Stainless Steel RAL 9006





## ADDITIONAL NOTES

Ships via UPS

Riga Stainless Steel units are suitable for outdoor use under cover.

Sample chips available.

LINE ART	MODEL	H	W	D	WEIGHT	DESCRIPTION	COLOR/FINISH	LIST PRICE
	RIGA-UMB-P	19 5/16"	9 13/16"	9 13/16"	10 lbs.	Umbrella stand with four sections for umbrellas and non-skid grid on bottom to hold umbrellas in place.	Grey White Ral 9002 with Black ABS base.	705.00
	RIGA-UMB	19 5/16"	9 13/16"	9 13/16"	10 lbs.	Umbrella stand with four sections for umbrellas and non-skid grid on bottom to hold umbrellas in place.	Stainless Steel with Black ABS base.	830.00

FRONT & BACK FINISH COLORS



Textured Black



Textured White

INTERIOR PANEL & BASE FINISH COLORS



Textured Black



Textured White



Mustard





Grey Beige

ADDITIONAL NOTES

Ships via UPS

Sample chips available.



LINE ART	MODEL	H	W	D	WEIGHT	DESCRIPTION	COLOR/FINISH	LIST PRICE
	SOU-FLR	24 1/4"	15 1/2"	5 3/4"	23 lbs.	Painted steel umbrella stand for both tall and short umbrellas. Base and middle panel can be painted contrasting color. Drip trays for both tall and short umbrellas included.	Textured Black Ral 9011, Textured White, Mustard Gloss Ral 1012, or Matte Grey Beige Ral 1019 for middle panel and base, Exterior panels in Textured Black Ral 9011 or Textured White.	1,225.00
	SOU-WALL	23 1/2"	15 1/2"	4 1/4"	21 lbs.	Wall mounted painted steel umbrella stand for both tall and short umbrellas. Middle panel can be painted contrasting color. Drip trays for both tall and short umbrellas included.	Textured Black Ral 9011, Textured White, Mustard Gloss Ral 1012, or Matte Grey Beige Ral 1019 for middle panel and base, Exterior panels in Textured Black Ral 9011 or Textured White.	1,225.00

## FINISH COLORS



White



Black

## ADDITIONAL NOTES

Ships via UPS

Sample chips available.



LINE ART	MODEL	H	W	D	WEIGHT	DESCRIPTION	COLOR/FINISH	LIST PRICE
	YIN-22	19 3/4"	15 3/4"	round	12 lbs.	Steel umbrella stand.	Red, Black or White	315.00

# INFORMATION & GRAPHIC DISPLAY

---

HOME → PRODUCTS → INFORMATION & GRAPHIC DISPLAY

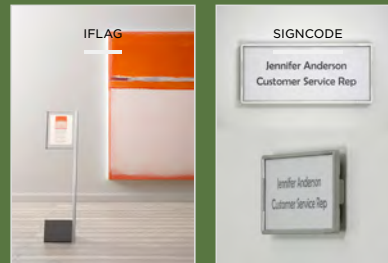

# IFLAG

## POST FINISH COLORS



Anodized Aluminum

## BASE FINISH COLORS



Textured Forge Grey



White



Satin Black RAL 9011

## ADDITIONAL NOTES

Ships via FedEx



LINE ART	MODEL	H	W	D	WEIGHT	DESCRIPTION	COLOR/FINISH	LIST PRICE
	IFLAG-10	50 13/16"	9 13/16"	17 11/16"	12 lbs.	Transparent methacrylate display for single poster/paper that is 8 1/4" x 11 11/16".	Post in Anodized Silver, base in Textured Forge Grey, Matte White Ral 9003 or Satin Black RAL 9011	785.00
	IFLAG-20	50 13/16"	9 13/16"	17 11/16"	14 lbs.	Transparent methacrylate display for two posters/papers that are 8 1/4" x 11 11/16".	Post in Anodized Silver, base in Textured Forge Grey, Matte White Ral 9003 or Satin Black RAL 9011	1,045.00
	IFLAG-30	50 13/16"	9 13/16"	17 11/16"	19 lbs.	Transparent methacrylate display for three posters/papers that are 8 1/4" x 11 11/16".	Post in Anodized Silver, base in Textured Forge Grey, Matte White Ral 9003 or Satin Black RAL 9011	1,345.00
	IFLAG-40	50 13/16"	9 13/16"	17 11/16"	12 lbs.	Transparent methacrylate display featuring a single shelf for brochures that are 8 1/4"x 11 11/16". Single sheet can also be inserted between methacrylate with brochures or papers on the shelf for take away.	Post in Anodized Silver, base in Textured Forge Grey, Matte White Ral 9003 or Satin Black RAL 9011	865.00
	IFLAG-50	50 13/16"	9 13/16"	17 11/16"	14 lbs.	Transparent methacrylate display featuring two shelves for brochures that are 8 1/4"x 11 11/16". Single sheet can also be inserted between methacrylate with brochures or papers on the shelf or shelves below for take away.	Post in Anodized Silver, base in Textured Forge Grey, Matte White Ral 9003 or Satin Black RAL 9011	1,155.00
	IFLAG-60	50 13/16"	9 13/16"	17 11/16"	19 lbs.	Transparent methacrylate display featuring three shelves for brochures that are 8 1/4"x 11 11/16". Single sheet can also be inserted between methacrylate with brochures or papers on the shelf or shelves for take away.	Post in Anodized Silver, base in Textured Forge Grey, Matte White Ral 9003 or Satin Black RAL 9011	1,495.00



# SIGNCODE

## ADDITIONAL NOTES

Ships via UPS



LINE ART	MODEL	H	W	D	WEIGHT	DESCRIPTION	COLOR/FINISH	LIST PRICE
	SIGNCODE-10PSM	2 9/16"	5 7/8"	3/8"	1 lb.	Graphic display holder with magnetic tape backing for use as workstation nameplate. Holds media 2 3/8" x 5 13/16"	Silver Anodized Aluminum frame with transparent cover.	65.00

# MESSAGE BOARD

---

[HOME](#) → [PRODUCTS](#) → [MESSAGE BOARD](#)



# PANTALLA

## FINISH COLORS



Black



White



Mustard



Grey Beige

## FREE STANDING UNIT FINISH COLORS



Black



White







## ADDITIONAL NOTES

Pantalla-S/M/L ship via UPS; Pantalla-FLR ships via common carrier.

White magnets are included. S unit includes 4, M unit includes 6, L unit includes 8 and FLR units include 10.

Sample chips available.



LINE ART	MODEL	H	W	D	WEIGHT	DESCRIPTION	COLOR/FINISH	LIST PRICE
	PANTALLA-FLR	71 11/16"	17 3/4"	18 1/8"	67 lbs.	Free standing vertical magnetic notice panel for various media that can also function as a room divider. Units can be used individually or grouped together.	Glossy White Ral 9003, Satin Black Ral 9011	2,645.00
	PANTALLA-S	17 5/16"	17 5/16"	3/16"	7 lbs.	Magnetic notice panel for various media. Units can be used individually or grouped together to create an original wall composition.	Satin Black RAL 9011, Matte Grey Beige RAL 1019, or Mustard Gloss RAL 1012	425.00
	PANTALLA-M	17 5/16"	34 5/8"	3/16"	14 lbs.	Magnetic notice panel for various media. Units can be used individually or grouped together to create an original wall composition.	Satin Black RAL 9011, Matte Grey Beige RAL 1019, or Mustard Gloss RAL 1012	675.00
	PANTALLA-L	17 5/16"	51 15/16"	3/16"	23 lbs.	Magnetic notice panel for various media. Units can be used individually or grouped together to create an original wall composition.	Satin Black RAL 9011, Matte Grey Beige RAL 1019, or Mustard Gloss RAL 1012	995.00
	PANTALLA-WS	17 5/16"	17 5/16"	3/16"	7 lbs.	Writeable magnetic notice panel for various media. Units can be used individually or grouped together to create an original wall composition.	Glossy White Ral 9003	425.00
	PANTALLA-WM	17 5/16"	34 5/8"	3/16"	14 lbs.	Writeable magnetic notice panel for various media. Units can be used individually or grouped together to create an original wall composition.	Glossy White Ral 9003	685.00
	PANTALLA-WL	17 5/16"	51 15/16"	3/16"	23 lbs.	Writeable magnetic notice panel for various media. Units can be used individually or grouped together to create an original wall composition.	Glossy White Ral 9003	1,015.00

# SHOWCASES

---

[HOME](#) → [PRODUCTS](#) → [SHOWCASES](#)

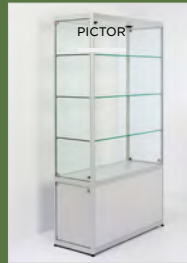

## ADDITIONAL NOTES

Ships via common carrier.

PICTOR units ending in "/K" have a locking cabinet at the base.

PICTOR VA040/050/060 units have one door and one LED spotlight. PICTOR VA080/100 units have two doors, one on each of the narrower 15 3/4" sides and two LED spotlights.



22lb weight capacity per shelf.

All glass in PICTOR is tempered glass.

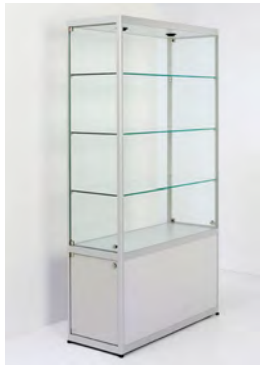
Sample chips available.



LINE ART	MODEL	H	W	D	WEIGHT	DESCRIPTION	COLOR/FINISH	LIST PRICE
	VA040	71 11/16"	15 3/4"	15 3/4"	91 lbs.	Showcase with tempered glass, 1 front opening door with cylinder lock, 4 fully adjustable glass shelves, and a LED spotlight, 2.3W.	Black or Satin Aluminum frame.	4,675.00
	VA040/K	71 11/16"	15 3/4"	15 3/4"	84 lbs.	Showcase with tempered glass, 1 front opening door with cylinder lock, 3 fully adjustable glass shelves and a LED spotlight, 2.3W, fitted with a locking cabinet in the base made of black or silver grey melamine MDF.	Black or Satin Aluminum frame with Black or Silver Grey melamine MDF cabinet.	5,395.00
	VA050	71 11/16"	19 11/16"	19 11/16"	125 lbs.	Showcase with tempered glass, 1 front opening door with cylinder lock, 4 fully adjustable glass shelves, and a LED spotlight, 2.3W.	Black or Satin Aluminum frame.	5,435.00
	VA050/K	71 11/16"	19 11/16"	19 11/16"	114 lbs.	Showcase with tempered glass, 1 front opening door with cylinder lock, 3 fully adjustable glass shelves and a LED spotlight, 2.3W, fitted with a locking cabinet in the base made of black or silver grey melamine MDF.	Black or Satin Aluminum frame with Black or Silver Grey melamine MDF cabinet.	6,195.00
	VA060	71 11/16"	23 5/8"	15 3/4"	121 lbs.	Showcase with tempered glass, 1 side opening door with cylinder lock, 4 fully adjustable glass shelves, and a LED spotlight, 2.3W.	Black or Satin Aluminum frame.	5,495.00
	VA060/K	71 11/16"	23 5/8"	15 3/4"	108 lbs.	Showcase with tempered glass, 1 side opening door with cylinder lock, 3 fully adjustable glass shelves and a LED spotlight, 2.3W, fitted with a locking cabinet in the base made of black or silver grey melamine MDF.	Black or Satin Aluminum frame with Black or Silver Grey melamine MDF cabinet.	6,350.00
	VA080	71 11/16"	31 1/2"	15 3/4"	152 lbs.	Showcase with tempered glass, 2 side opening doors (on short sides) with cylinder lock, 4 fully adjustable glass shelves, and 2 LED spotlights, 2.3W.	Black or Satin Aluminum frame.	6,595.00
	VA080/K	71 11/16"	31 1/2"	15 3/4"	139 lbs.	Showcase with tempered glass, 2 side opening doors (on short side) with cylinder locks, 3 fully adjustable glass shelves and and 2 LED spotlights, 2.3W, fitted with a locking cabinet in the base made of black or silver grey melamine MDF.	Black or Satin Aluminum frame with Black or Silver Grey melamine MDF cabinet.	7,695.00

	VA100	71 11/16"	39 3/8"	15 3/4"	170 lbs.	Showcase with tempered glass, 2 side opening doors (on short sides) with cylinder lock, 4 fully adjustable glass shelves, and 2 LED spotlights, 2.3W.	Black or Satin Aluminum frame.	7,865.00
	VA100/K	71 11/16"	39 3/8"	15 3/4"	150 lbs	Showcase with tempered glass, 2 side opening doors (on short side) with cylinder locks, 3 fully adjustable glass shelves and 2 LED spotlights, 2.3W, fitted with a locking cabinet in the base made of black or silver grey melamine MDF.	Black or Satin Aluminum frame with Black or Silver Grey melamine MDF cabinet.	8,550.00

# SHELVING & BOOKSHELVES

---

HOME → PRODUCTS → SHELVING & BOOKSHELVES

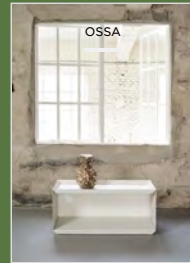
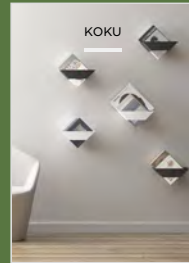

# BALDAS

## FINISH COLORS



Matte White



Grey Beige



Textured Forge Grey

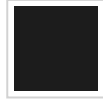

Black

## ADDITIONAL NOTES

Ships via UPS.

Mounting brackets must be securely anchored in the wall. Once in place, the shelf attaches directly to the mounting bracket.

The shelves, once mounted, allow for vertical adjustment of ~1/2" to achieve the desired height. The shelf can also be adjusted horizontally by moving it very slightly to the right or left, to attach it to the adjoining shelf, or to leave space between an adjacent shelf.

Screws and mollies are included.

Weight capacity of BALDAS-S & BALDAS-R is 15lbs.

Weight capacity of BALDAS-M is 39lbs.

Sample chips available.



LINE ART	MODEL	H	W	D	WEIGHT	DESCRIPTION	COLOR/FINISH	LIST PRICE
	BALDAS-S	12 1/4"	7 1/8"	7 1/2"	4 lbs.	Painted aluminum vertical wall mounted shelf. Comes with 1 wall mounting bracket.	Matte White RAL 9003, Satin Black RAL 9011, Textured Forge Grey or Matte Grey Beige RAL 1019	445.00
	BALDAS-R	12 1/4"	7 1/8"	7 1/2"	4 lbs.	Painted aluminum vertical wall mounted shelf. Comes with 1 wall mounting bracket.	Matte White RAL 9003, Satin Black RAL 9011, Textured Forge Grey or Matte Grey Beige RAL 1019	445.00
	BALDAS-M	4 3/4"	39 3/8"	7 1/2"	10 lbs.	Painted aluminum horizontal wall mounted shelf. Comes with 2 wall mounting brackets.	Matte White RAL 9003, Satin Black RAL 9011, Textured Forge Grey or Matte Grey Beige RAL 1019	710.00



## FINISH COLORS



Black



White



Mustard



Grey Beige

## ADDITIONAL NOTES

Ships via UPS

Sample chips available.



LINE ART	MODEL	H	W	D	WEIGHT	DESCRIPTION	COLOR/FINISH	LIST PRICE
	KOKU	2 3/4"	11 1/16"	6 3/4"	4 lbs.	Painted steel wall mounted book shelf with concealed mounting system.	Matte White Ral 9003, Matte Grey Beige Ral 1019, Matte Mustard Ral 1012, Satin Black Ral 9011	465.00

# OSSA

## FINISH COLORS

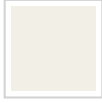

White



Pistachio



Dark Grey

## ADDITIONAL NOTES



Ships via common carrier.

OSSA is stackable up to 3 units high.

When stacked, each additional unit adds 15" to height. Handle cut out is 1" high x 4 1/4" long. Top shelf area is 1 3/4" high x 33 1/4" wide x 12 1/4" deep.

Sample chips available.



LINE ART	MODEL	H	W	D	WEIGHT	DESCRIPTION	COLOR/FINISH	LIST PRICE
	OSSA	16 1/2"	35 7/16"	14 3/4"	38 lbs.	Modular storage unit made of powder coated steel. Units can be stacked up to 3 units high.	White, Pistachio or Dark Grey	1,475.00
	OSSA-CORK	1 3/4"	16 1/2"	12"	4 lbs.	Fine grain cork for top of OSSA; covers half the top shelf.	Cork	520.00
	OSSA-LEATHER	1/4"	33"	12"	2 lbs.	Saddle leather cover for top of OSSA.	Leather	685.00

## COLUMN FINISH COLORS



Anodized Aluminum

## SHELVES FINISH COLORS



Black



Textured Forge Grey



White



## ADDITIONAL NOTES

Usio-W ships via FedEx; Usio-FS/FD ship via common carrier.

All Usio shelves are 6 1/8" apart.

Sample chips available.



LINE ART	MODEL	H	W	D	WEIGHT	DESCRIPTION	COLOR/FINISH	LIST PRICE
	USIO-W	64 1/2"	6 1/4"	6 1/8"	21 lbs.	Wall mounted bookshelf with aluminum center column with 10 painted steel fixed height shelves.	Anodized Silver Matte column, shelves in Textured Forge Grey, Matte White Ral 9003 or Satin Black Ral 9011	925.00
	USIO-FS	64 9/16"	9 3/4"	9 7/8"	35 lbs.	Floor standing single sided bookshelf with aluminum center column with 10 painted steel fixed height shelves.	Anodized Silver Matte column, shelves in Textured Forge Grey, Matte White Ral 9003 or Satin Black Ral 9011	1,475.00
	USIO-FD	64 9/16"	9 3/4"	19 3/4"	57 lbs.	Floor standing double sided bookshelf with aluminum center column with 20 painted steel fixed height shelves.	Anodized Silver Matte column, shelves in Textured Forge Grey, Matte White Ral 9003 or Satin Black Ral 9011	2,195.00

# CROWD CONTROL

HOME → PRODUCTS → CROWD CONTROL

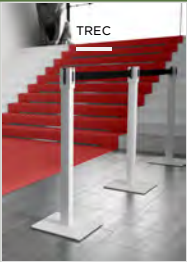

# STOPPER POINT



## ADDITIONAL NOTES

Ships via UPS

STOPPER POINT units have an integrated belt braking system, which slowly retracts the belt into the post.

Units can be placed up to 97.5" apart from one another.



LINE ART	MODEL	H	W	D	WEIGHT	DESCRIPTION	COLOR/FINISH	LIST PRICE
	STOP-POINT	38 3/16"	13"	round	19 lbs.	Single crowd control stanchion with 97.5" long band.	Matte Silver post and base or Black RAL 9004 post and base. Band housing in Black. Band in Black, Blue or Red.	385.00
	STOP-02					Acrylic poster holder for single sheet 8 1/4" wide x11 11/16" high double sided view with magnetic lock.	Green glass	190.00
	STWC-90					Wall mount plastic support for use with Stopper.	Black	78.00

# TEMPALINE





## ADDITIONAL NOTES

Ships via UPS

Tempaline is suitable for outdoor use.

Units can be placed up to 80" apart from one another.



LINE ART	MODEL	H	W	D	WEIGHT	DESCRIPTION	COLOR/FINISH	LIST PRICE
	TPL-950-SBL	37 3/8"	20 1/16"	20 1/16"	6 lbs.	Transportable crowd control stanchion for indoor/outdoor use. Blue 80" long retractable belt.	Silver Matte Anodized Aluminum stanchion, Black ABS plastic base and belt housing with blue belt	835.00
	TPL-SET950-SBL	37 3/8"	20 1/16"	20 1/16"	30 lbs.	Set of four foldable crowd control stanchions for indoor/outdoor use. Blue 80" long retractable belt. Includes blue padded carry bag.	Silver Matte Anodized Aluminum stanchion, Black ABS plastic base and belt housing with blue belt	3,335.00
	TPL-QA5H				1 lb.	Double sided poster pocket Clear fits stanchion, landscape orientation. Media size 5 13/16" x 8 1/4".	Clear	95.00
	TPL-QA4H				1 lb.	Double sided poster pocket fits stanchion, landscape orientation. Media size 8 1/4" x 11 11/16".	Clear	135.00
	TPL-QA4V				1 lb.	Double sided poster pocket fits stanchion, portrait orientation. Media size 11 11/16" x 8 1/4".	Clear	135.00

## FINISH COLORS



Matte White



Textured Forge Grey



Black

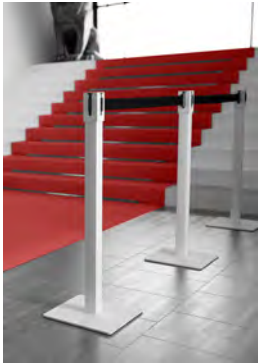





## ADDITIONAL NOTES

Ships via UPS.

Each TREC-F unit ships in 2 cartons.

Band is 9ft long and approximately 1/8" thick.

Sample chips available.

LINE ART	MODEL	H	W	D	WEIGHT	DESCRIPTION	COLOR/FINISH	LIST PRICE
	TREC-F	38 13/16"	11 3/4"	11 3/4"	22 lbs.	Freestanding crowd control unit with painted steel base and top with aluminum column. Top houses one band.	Textured Forge Grey, Satin Black RAL 9011 or Matte White RAL 9003. Band in Black, Blue or Red.	995.00
	TREC-WB	4 7/8"	5 1/8"	4 1/2"	1 lb.	Wall mounted crowd control unit made of painted steel. Houses one band.	Textured Forge Grey, Satin Black RAL 9011 or Matte White RAL 9003. Band in Black, Blue or Red.	595.00
	TREC-WR	2 13/16"	1 9/16"	3/8"	1/2 lb.	Wall mounted band receiving unit made of painted steel.	Textured Black Ral 9011	145.00
	TREC-SIGN	11 15/16"	10"	2 1/2"	2 lbs.	Painted aluminum and steel signage holder for TREC-F with clear methacrylate. Holds A4 media 8.3" wide by 11.7" high. Double sided visibility, secures to the top of TREC-F.	Textured Forge Grey, Satin Black Ral 9011 or Matte White RAL 9003.	545.00

# SANITIZATION & PPE STATIONS

---

[HOME](#) → [PRODUCTS](#) → [SANITIZATION & PPE STATIONS](#)





# HAANDER

## FINISH COLORS



Lunar White



Anodized Silver



Textured Raven Black

## ADDITIONAL NOTES

Ships via UPS

Magnuson Group does not sell hand sanitizer dispensers.

HAANDER's free standing and wall-mounted models are designed to work with a wide variety of 3rd party hand sanitizer dispenser units [both touch free and push style models]. Any dispenser that fits within 7 3/4" wide by 14" high is compatible and can be most easily mounted using double sided adhesive tape, which is often included with the dispenser.

HAANDER's mounting holes align with many PURELL® Push-Style Dispensers (NXT, ES4, FMX) and PURELL® Touch-Free Dispensers (TFX, LTX, ES6 & ES8), making installation easy. ©2015. GOJO Industries, Inc. All rights reserved.

HAANDER-W: Mounts to the wall with 4 screws. Dispensers are mounted to HAANDER-W using either double sided adhesive tape (often included with dispenser) or with hardware. If the dispenser is a compatible PURELL® product, mounting holes are aligned for easy installation with hardware.

HAANDER-F: Painted steel dispenser housing mounts to post with hardware provided. Dispensers are mounted to painted steel housing using either double sided adhesive tape (often included with dispenser) or with hardware if the dispenser is a compatible PURELL® product. Mounting the dispenser to the painted steel housing with hardware is not possible unless the dispenser is a compatible PURELL® product. The painted steel base is 1/4" high off the ground.

HAANDER-W includes 4 drywall screws and 4 wall anchors to mount HAANDER-W to drywall. For other applications, customer will need to supply their own hardware.

HAANDER-F includes all hardware to mount the dispenser housing to the freestanding post and base.

Sample chips available.



LINE ART	MODEL	H	W	D	WEIGHT	DESCRIPTION	COLOR/FINISH	LIST PRICE
	HAANDER-W	19"	8"	4"	5 lbs.	Wall mounted painted steel hand sanitizer dispenser station with silkscreened hand sanitizer graphic.	Lunar White, Anodized Silver or Textured Raven Black	225.00
	HAANDER-F	54 1/2"	15 1/2"	15 1/2"	43 lbs.	Freestanding painted steel hand sanitizer dispenser station with silkscreened hand sanitizer graphic.	Lunar White, Anodized Silver or Textured Raven Black	495.00

# ISBIT

## FINISH COLORS



Lunar White



Anodized Silver



Textured Raven Black

## ADDITIONAL NOTES

Ships via UPS

Magnuson Group does not include hand sanitizer with ISBIT.

ISBIT is designed to be compatible with most 16.9oz (500ml) hand sanitizer pump bottles. The height of the body of the bottle (measured from bottom of the bottle to the bottom of the bottle neck) cannot exceed 6" in height in order to fit within the acrylic housing. The height of the bottle's pump at full compression must be above 6 1/2" in order to function within the acrylic housing.



ISBIT-W mounts to the wall with 4 screws. Hardware & wall anchors for drywall application are included with the product. For other applications, customer will need to supply their own hardware.

ISBIT-M mounts to any steel surface with two heavy duty magnets.

ISBIT-F painted steel frame and acrylic housing mounts to the post with hardware provided. The painted steel base is 1/4" high off the ground.

Sample chips available.



LINE ART	MODEL	H	W	D	WEIGHT	DESCRIPTION	COLOR/FINISH	LIST PRICE
	ISBIT-W	7 1/8"	5 1/8"	4"	2 lbs.	Wall mounted painted steel hand sanitizer station for pump bottle with removeable clear acrylic housing.	Lunar White, Anodized Silver or Textured Raven Black Frame with Clear Acrylic Housing.	225.00
	ISBIT-M	7 1/8"	5 1/8"	4"	2 lbs.	Magnetic painted steel hand sanitizer station for pump bottle with removeable clear acrylic housing.	Lunar White, Anodized Silver or Textured Raven Black Frame with Clear Acrylic Housing.	255.00
	ISBIT-F	40"	15 1/2"	15 1/2"	25 lbs.	Freestanding painted steel hand sanitizer station for pump bottle with removeable clear acrylic housing.	Lunar White, Anodized Silver or Textured Raven Black Frame, Post and Base with Clear Acrylic Housing.	475.00

# SOLNA FREESTANDING

## FINISH COLORS



Bronze Metallic



Anodized Silver



Dark Anthracite



Lunar White

## SANITIZATION & PPE OPTIONS

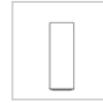

Dispenser Bracket  
14 1/2" H x 5 1/4" W  
with 3 5/16" Drip tray



Masks  
4 1/2" H x 2 3/8" W  
each



Masks & Gloves  
Masks: 4 1/2" H x 2 3/8" W each  
Gloves 13" H x 5" W

## GRAPHIC LABEL OPTIONS



Virus Prevention



Disposable PPE



Sanitizer



Masks



Wipes



Gloves



Tissues



Masks/Tissues



Masks/Wipes



Masks & Gloves

## GRAPHIC LABEL FINISH COLORS



White Vinyl



Dark Grey Vinyl

## ADDITIONAL NOTES

Ships via common carrier.

Masks PPE cabinet is compatible with many standard disposable mask boxes. Designed for two mask boxes (stacked on top of one another) each measuring up to 7 3/4" high by 5" wide by 4 1/4" deep.

Gloves PPE cabinet is compatible with many standard disposable gloves and tissue boxes. Gloves PPE cabinet is designed for three gloves or tissues boxes up to 10" wide by 5" high by 4 1/4" deep.

SOLNA FREESTANDING PPE cabinets open from top to bottom and come with internal magnetic "L Bracket" that ensures secure fit for PPE. Masks PPE cabinet includes one magnetic "L Bracket". Masks & Gloves PPE cabinet includes two magnetic "L Brackets".

SOLNA is compatible with a wide variety of 3rd party hand sanitizer dispenser units [both touch free and push style models]. Any dispenser up to 10" wide by 12" high is compatible and can be most easily mounted using double sided adhesive tape, which is often included with the dispenser.





Magnuson Group does not sell hand sanitizer dispensers. SOLNA's mounting holes align with many PURELL® Push-Style Dispensers (NXT, ES4, FMX) and PURELL® Touch-Free Dispensers (TFX, LTX, ES6 & ES8), making installation easy. ©2015. GOJO Industries, Inc. All rights reserved.

Assembly required: Use hardware provided to attach the base to upright. Then, attach PPE cabinet or dispenser bracket to upright. SOLNA-FS-18-MD dispenser bracket and masks cabinet can be placed on either the left or right side (mounting holes are identical).

SOLNA meets or exceeds the minimum requirements per ANSI/BIFMA X5.6-2016 Panel Systems.

Sample chips available.



LINE ART	MODEL	H	W	D	WEIGHT	DESCRIPTION	COLOR/FINISH	LIST PRICE
	SOLNA-FS-09-D	55 7/8"	11"	15"	38 lbs.	Freestanding sanitization station made of painted steel with drip tray for hand sanitizer dispenser, includes one label.	Dark Anthracite, Anodized Silver, Lunar White, Bronze Metallic	1,045.00
	SOLNA-FS-09-M	55 7/8"	11"	15"	40 lbs.	Freestanding PPE station made of painted steel with locking cabinet for masks, includes one label.	Dark Anthracite, Anodized Silver, Lunar White, Bronze Metallic	1,095.00
	SOLNA-FS-18-MD	55 7/8"	20"	15"	73 lbs.	Freestanding PPE & sanitization station made of painted steel with locking cabinet for masks & drip tray for hand sanitizer dispenser, includes one label.	Dark Anthracite, Anodized Silver, Lunar White, Bronze Metallic	1,645.00
	SOLNA-FS-18-MG	55 7/8"	20"	15"	77 lbs.	Freestanding PPE station made of painted steel with locking cabinet for masks & gloves, includes one label.	Dark Anthracite, Anodized Silver, Lunar White, Bronze Metallic	1,765.00

# SOLNA WITH RECEPTACLE

## FINISH COLORS



Bronze Metallic



Anodized Silver

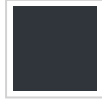

Dark Anthracite



Lunar White

## SANITIZATION & PPE OPTIONS



Dispenser Bracket  
14 1/2" H x 5 1/4" W  
with 3 5/16" Drip tray



Masks  
4 1/2" H x 2 3/8" W  
each



Masks & Gloves  
Masks: 4 1/2" H x 2 3/8" W each  
Gloves 13" H x 5" W

## WASTE RECEPTACLE COMPATIBILITY



VALUTA VA1814L



VALUTA VA1818L



2x VALUTA  
VA1809L



SOTARE SO1818L



SOTARE SO1818L-  
DBL

## HOW TO ORDER



Select SOLNA  
Model



Select Color



Select VALUTA or  
SOTARE Unit(s)



Select Body Color



Select Top Color



Select Top Opening



Select Label &  
Color

## ADDITIONAL NOTES

Ships via common carrier.

Masks PPE cabinet is compatible with many standard disposable mask boxes. Designed for two mask boxes (stacked on top of one another) each measuring up to 7 ¾" high by 5" wide by 4 ¼" deep.

Gloves PPE cabinet is compatible with many standard disposable gloves and tissue boxes. Gloves PPE cabinet is designed for three gloves or tissues boxes up to 10" wide by 5" high by 4 ¼" deep.

SOLNA panel above receptacle opens from right to left to allow full range of motion for VALUTA or SOTARE lid. PPE cabinets open from top to bottom and comes with internal magnetic "L Bracket" that ensures secure fit for PPE. Masks PPE cabinet includes one magnetic "L Bracket". Masks & Gloves PPE cabinet includes two magnetic "L Brackets".

SOLNA with Receptacle cannot be positioned directly next to another SOLNA with Receptacle unit and must have a 9" gap or greater between adjacent units due to the hinged panel that opens from right to left. SOLNA with Receptacle can be positioned directly next to a VALUTA or SOTARE Waste Receptacle only.







SOLNA is compatible with a wide variety of 3rd party hand sanitizer dispenser units [both touch free and push style models]. Any dispenser up to 10" wide by 12" high is compatible and can be most easily mounted using double sided adhesive tape, which is often included with the dispenser.







Magnuson Group does not sell hand sanitizer dispensers. SOLNA's mounting holes align with many PURELL® Push-Style Dispensers (NXT, ES4, FMX) and PURELL® Touch-Free Dispensers (TFX, LTX, ES6 & ES8), making installation easy. ©2015. GOJO Industries, Inc. All rights reserved.

Assembly required: Use hardware provided to attach the panel to the VALUTA or SOTARE waste receptacle. Then, attach PPE cabinet or dispenser bracket to upright. On SOLNA-MD models, the dispenser bracket and masks cabinet can be placed on either the left or right side (mounting holes are identical).

Sample chips available.



LINE ART	MODEL	H	W	D	WEIGHT	DESCRIPTION	COLOR/FINISH	LIST PRICE
	SOLNA-ADD-18-MD	55 7/8"	18"	5 3/4"	26 lbs.	Add on SOLNA panel to retrofit existing VALUTA or SOTARE Waste Receptacles for PPE & sanitization. Made of painted steel with locking cabinet for masks & driptray for hand sanitizer dispenser.	Dark Anthracite, Anodized Silver, Lunar White, Bronze Metallic	1,150.00
	SOLNA-ADD-18-MG	55 7/8"	18"	5 3/4"	30 lbs.	Add on SOLNA panel to retrofit existing VALUTA or SOTARE Waste Receptacles for PPE. Made of painted steel with locking cabinet for masks & gloves.	Dark Anthracite, Anodized Silver, Lunar White, Bronze Metallic	1,150.00
	SOLNA-PLUS-18-MD-VA1814L	55 7/8"	18"	15 1/2"	73 lbs.	VALUTA VA1814L receptacle with SOLNA PPE & sanitization station made of painted steel with locking cabinet for masks & driptray for hand sanitizer dispenser.	Dark Anthracite, Anodized Silver, Lunar White, Bronze Metallic	2,245.00
	SOLNA-PLUS-18-MG-VA1814L	55 7/8"	18"	15 1/2"	77 lbs.	VALUTA VA1814L receptacle with SOLNA PPE station made of painted steel with locking cabinet for masks & gloves.	Dark Anthracite, Anodized Silver, Lunar White, Bronze Metallic	2,245.00
	SOLNA-PLUS-18-MD-VA1818L	55 7/8"	18"	19 1/2"	80 lbs.	VALUTA VA1818L receptacle with SOLNA PPE & sanitization station made of painted steel with locking cabinet for masks & driptray for hand sanitizer dispenser.	Dark Anthracite, Anodized Silver, Lunar White, Bronze Metallic	2,345.00
	SOLNA-PLUS-18-MG-VA1818L	55 7/8"	18"	19 1/2"	84 lbs.	VALUTA VA1818L receptacle with SOLNA PPE station made of painted steel with locking cabinet for masks & gloves.	Dark Anthracite, Anodized Silver, Lunar White, Bronze Metallic	2,345.00

	SOLNA-PLUS-18-MD-2xVA1809L	55 7/8"	18"	19 1/2"	86 lbs.	VALUTA VA1809L receptacles with SOLNA PPE & sanitization station made of painted steel with locking cabinet for masks & drip tray for hand sanitizer dispenser.	Dark Anthracite, Anodized Silver, Lunar White, Bronze Metallic	3,135.00
	SOLNA-PLUS-18-MG-2xVA1809L	55 7/8"	18"	19 1/2"	90 lbs.	VALUTA VA1809L receptacles with SOLNA PPE station made of painted steel with locking cabinet for masks & gloves.	Dark Anthracite, Anodized Silver, Lunar White, Bronze Metallic	3,135.00
	SOLNA-PLUS-18-MD-SO1818L	55 7/8"	18"	19 1/2"	75 lbs.	SOTARE SO1818L receptacle with SOLNA PPE & sanitization station made of painted steel with locking cabinet for masks & drip tray for hand sanitizer dispenser.	Dark Anthracite, Anodized Silver, Lunar White, Bronze Metallic	3,140.00
	SOLNA-PLUS-18-MG-SO1818L	55 7/8"	18"	19 1/2"	79 lbs.	SOTARE SO1818L receptacle with SOLNA PPE station made of painted steel with locking cabinet for masks & gloves.	Dark Anthracite, Anodized Silver, Lunar White, Bronze Metallic	3,140.00
	SOLNA-PLUS-18-MD-SO1818L-DBL	55 7/8"	18"	19 1/2"	75 lbs.	SOTARE SO1818L-DBL double top opening receptacle with SOLNA PPE & sanitization station made of painted steel with locking cabinet for masks & drip tray for hand sanitizer dispenser.	Dark Anthracite, Anodized Silver, Lunar White, Bronze Metallic	3,295.00
	SOLNA-PLUS-18-MG-SO1818L-DBL	55 7/8"	18"	19 1/2"	79 lbs.	SOTARE SO1818L-DBL double top opening receptacle with SOLNA PPE station made of painted steel with locking cabinet for masks & gloves.	Dark Anthracite, Anodized Silver, Lunar White, Bronze Metallic	3,295.00

# COAT HOOKS MAGNETIC

---

HOME → PRODUCTS → COAT HOOKS MAGNETIC





# K-50 MAGNETIC

## ADDITIONAL NOTES

Ships via UPS

Sample chips available.



LINE ART	MODEL	H	W	D	WEIGHT	DESCRIPTION	COLOR/FINISH	LIST PRICE
	K-50M	3 1/2"	3 1/2"	2"	1 lb.	Magnetic coat hook with painted round back plate and die cast zinc coat hook. K-50M has a weight capacity of 20lbs	Backplate in Black, Silver, White, Marine Blue or Marigold Yellow. Knob in Black, Silver, White, Marine Blue, Marigold Yellow, Polished Chrome or Brushed Chrome.	76.00

# KOBE-MA

## ADDITIONAL NOTES

Ships via UPS.



LINE ART	MODEL	H	W	D	WEIGHT	DESCRIPTION	COLOR/FINISH	LIST PRICE
	KOBE-MA	5"	4"	2 3/4"	1 lbs.	Magnetic coat hook. Kobe has a weight capacity of 18lbs	Back plate in White or Black, ABS hook in White, Black, Silver or Red	120.00

# KROK MAGNETIC

## ADDITIONAL NOTES

Ships via UPS

Sample chips available.



LINE ART	MODEL	H	W	D	WEIGHT	DESCRIPTION	COLOR/FINISH	LIST PRICE
	KROK-MA	5"	3 1/2"	3 5/8"	1 lbs.	Magnetic coat hook with plastic hook. Krok has a weight capacity of 20lbs.	Dark Grey back plate with hook in Black 9311, White 9310, Light Blue 5324, Dark Blue 5311, Dark Green 6309, Red 3309 or Yellow 1304	139.00

# MEM

## ADDITIONAL NOTES

Ships via UPS.





LINE ART	MODEL	H	W	D	WEIGHT	DESCRIPTION	COLOR/FINISH	LIST PRICE
	MEM	5"	3 1/8"	3 3/16"	1 lb.	Magnetic coat hook with wood knob. MEM has a weight capacity of 18lbs	Back plate in Black, White, Sand, Silver, Chocolate or Green, hook in Beech, Wengue, White, Black or Green	125.00

# MYIM/MYIM JR

## ADDITIONAL NOTES

Ships via UPS.



LINE ART	MODEL	H	W	D	WEIGHT	DESCRIPTION	COLOR/FINISH	LIST PRICE
	MYIM	5"	3"	1 7/8"	2 lb.	Magnetic coat hook. MYIM has a weight capacity of 18lbs.	Back plate and hook in White, Sand, Clay, Silver, Black, Red or Chocolate.	155.00
	MYIM-JR.	3"	1 3/8"	1 5/8"	1 lb.	Small magnetic coat hook. MYIM Jr has a weight capacity of 4lbs.	Back plate and hook in White, Sand, Clay, Silver, Black, Red or Chocolate.	105.00

# NINO MAGNETIC

## ADDITIONAL NOTES

Ships via UPS

Sample chips available.

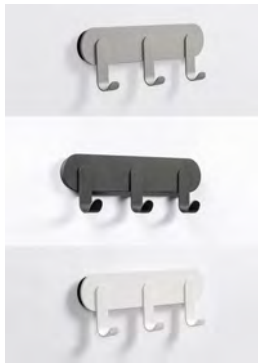

LINE ART	MODEL	H	W	D	WEIGHT	DESCRIPTION	COLOR/FINISH	LIST PRICE
	NINO H25	3 1/4"	9 7/8"	1 1/2"	1 lb.	Magnetic coat hook strip with 3 metal coat hooks. NINO-H25 has a weight capacity of 9lbs.	Black 9311, White 9310 or Metallic Grey 9306	265.00

# OLEA-MA

## ADDITIONAL NOTES

Ships via common carrier.



LINE ART	MODEL	H	W	D	WEIGHT	DESCRIPTION	COLOR/FINISH	LIST PRICE
	OLEA-MA	5"	2 5/8"	3 3/8"	2 lbs.	Magnetic coat hook with wood knob. OLEA has a weight capacity of 18lbs	Back plate in Black, Silver or White with knob in Beech or Black	130.00

# SHERWOOD

## ADDITIONAL NOTES

Ships via UPS









LINE ART	MODEL	H	W	D	WEIGHT	DESCRIPTION	COLOR/FINISH	LIST PRICE
	SW-MA	4 15/16"	3 15/16"	2 7/8"	1 lb.	Magnetic coat hook with wood knob.	Backplate and stem in White or Textured Black paint, with wood hook in Natural Beech, White or Black painted finish.	126.00

# TERTIO MAGNETIC

## ADDITIONAL NOTES

Ships via UPS.



LINE ART	MODEL	H	W	D	WEIGHT	DESCRIPTION	COLOR/FINISH	LIST PRICE
	T-10M	11 13/16"	17 11/16"	3 15/16"	2 lbs.	Magnetic hook with one dark grey plastic hanger. Weight capacity of 20lbs	Aluminum with Dark Grey	230.00
	T-16M	11 13/16"	17 11/16"	6 5/16"	2 lbs.	Magnetic hook with two dark grey plastic hangers. Weight capacity of 20lbs	Aluminum with Dark Grey	330.00
	T-H40M	4 1/4"	15 3/4"	1 15/16"	2 lbs.	Magnetic hook strip with four dark grey plastic hooks. Weight capacity of 20lbs	Aluminum with Dark Grey	360.00
	T-HM	3 3/4"	3 3/4"	1 15/16"	1 lbs.	Magnetic coat hook. Weight capacity of 20lbs	Dark Grey	165.00
	T-H37M	3 3/4"	14 3/4"	2 3/16"	3 lbs.	Magnetic hook strip with three dark grey plastic hooks. Weight capacity of 20lbs	Dark Grey	330.00
	T-HKM	8 1/4"	17 15/16"	2 1/2"	2 lbs.	Magnetic hook with hanger. Weight capacity of 20lbs	Black magnet, Brushed Stainless Steel hook with polished steel front, hanger in varnished Beech with Brushed Stainless Steel hook.	380.00

# COAT HOOKS

HOME → PRODUCTS → COAT HOOKS

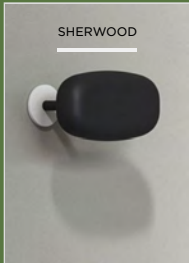
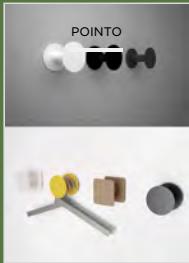

# BAMBU

## ADDITIONAL NOTES

Ships via UPS



LINE ART	MODEL	H	W	D	WEIGHT	DESCRIPTION	COLOR/FINISH	LIST PRICE
	BAMBU-06	1 3/8"	0	1 9/16"	1/4 lb.	Small ABS plastic hook.	Grey White Ral 9002 or Grey Ral 7022	32.00
	BAMBU-08	3 3/8"	0	1 9/16"	1/2 lb.	Large ABS plastic hook.	Grey White Ral 9002 or Grey Ral 7022	35.00

# CANTHA

## FINISH COLORS



Matte Grey Beige  
RAL 1019



Glossy Mustard RAL  
1012



Matte White

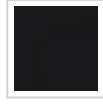

Satin Black RAL  
9011

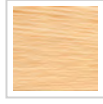

Matte Oak

## ADDITIONAL NOTES

Ships via UPS

Due to the manufacturing process, slight variations may be present.

CANTHA is mounted using a threaded bolt that is screwed into the wall. Once in place, the hook is screwed into the bolt.

Sample chips available.



LINE ART	MODEL	H	W	D	WEIGHT	DESCRIPTION	COLOR/FINISH	LIST PRICE
	CANTHA-S	1 1/2"	1 9/16"	1 1/4"	1 lb.	Painted aluminum coat hook.	Matte White, Matte Grey Beige RAL 1019, Mustard Gloss RAL 1012, Satin Black RAL 9011	130.00
	CANTHA-SW	1 1/2"	1 9/16"	1 1/4"	1 lb.	Painted aluminum coat hook with oak veneer front plate.	Matte White, Matte Grey Beige RAL 1019, Mustard Gloss RAL 1012, Satin Black RAL 9011 Hook with Matte Oak front plate	180.00
	CANTHA-M	2 1/4"	2 3/8"	1 1/4"	1 lb.	Painted aluminum coat hook.	Matte White, Matte Grey Beige RAL 1019, Mustard Gloss RAL 1012, Satin Black RAL 9011	165.00
	CANTHA-MW	2 1/4"	2 3/8"	1 1/4"	1 lb.	Painted aluminum coat hook with oak veneer front plate.	Matte White, Matte Grey Beige RAL 1019, Mustard Gloss RAL 1012, Satin Black RAL 9011 Hook with Matte Oak front plate	215.00
	CANTHA-L	3 1/2"	3 15/16"	1 5/8"	1 lb.	Painted aluminum coat hook.	Matte White, Matte Grey Beige RAL 1019, Mustard Gloss RAL 1012, Satin Black RAL 9011	220.00
	CANTHA-LW	3 1/2"	3 15/16"	1 5/8"	1 lb.	Painted aluminum coat hook with oak veneer front plate.	Matte White, Matte Grey Beige RAL 1019, Mustard Gloss RAL 1012, Satin Black RAL 9011 Hook with Matte Oak front plate	285.00
	CANTHA-XL	5 1/4"	5 1/2"	1 5/8"	1 lb.	Painted aluminum coat hook.	Matte White, Matte Grey Beige RAL 1019, Mustard Gloss RAL 1012, Satin Black RAL 9011	240.00
	CANTHA-XLW	5 1/4"	5 1/2"	1 5/8"	1 lb.	Painted aluminum coat hook with oak veneer front plate.	Matte White, Matte Grey Beige RAL 1019, Mustard Gloss RAL 1012, Satin Black RAL 9011 Hook with Matte Oak front plate	295.00















# K SERIES HOOKS













## ADDITIONAL NOTES















Ships via UPS



Use Front Mount hooks when mounting directly into a wall, door or surface or when access to the back of the knob cannot be reached.



LINE ART	MODEL	H	W	D	WEIGHT	DESCRIPTION	COLOR/FINISH	LIST PRICE
	K-50C/FM	1 1/4"	1 1/4"	1 9/16"	1/4 lb.	Front mount zinc die cast knob	<b>Polished Chrome</b>	53.00
								 <b>quick ship</b>
	K-50BC/FM	1 1/4"	1 1/4"	1 9/16"	1/4 lb.	Front mount zinc die cast knob	<b>Brushed Chrome</b>	55.00
								 <b>quick ship</b>
	K-50N/FM	1 1/4"	1 1/4"	1 9/16"	1/4 lb.	Front mount zinc die cast knob, Powder coat finish	Black, White or Silver	49.00
	K-55C/FM	1 3/8"	1 3/8"	2 13/16"	1/2 lb.	Front mount zinc die cast knob	<b>Polished Chrome</b>	55.00
								 <b>quick ship</b>
	K-55BC/FM	1 3/8"	1 3/8"	2 13/16"	1/2 lb.	Front mount zinc die cast knob	<b>Brushed Chrome</b>	58.00
								 <b>quick ship</b>
	K-55N/FM	1 3/8"	1 3/8"	2 13/16"	1/2 lb.	Front mount zinc die cast knob, Powder coat finish	Black, White or Silver	54.00
	K-50/FMP	3"	3"	1 3/4"	1 lb.	Front mount die cast steel garment bag hook	Brushed Chrome or Polished Chrome	95.00
	K-73	3 1/4"	4"	2 1/2"	1/4 lb.	Triple prong hook for 3/4" square tubing	Charcoal Grey, Black, or Sandstone	28.00
	K-300C	4 9/16"	3 3/8"	2"	1 lb.	Front mount aluminum hook	Chrome	70.00

	K-300MS	4 9/16"	3 3/8"	2"	1 lb.	Front mount aluminum hook	Metallic Silver	62.00
	K-305MS	3 3/16"	3 3/16"	1 1/16"	1 lb.	Front mount aluminum hook	Metallic Silver	54.00
	K-310C	1 1/2"	3 1/2"	1 1/4"	1 lb.	Front mount zinc hook	Chrome	43.00
	K-310MS	1 1/2"	3 1/2"	1 1/4"	1 lb.	Front mount zinc hook	Metallic Silver	39.00
	K-315C	2 3/16"	2 1/2"	1 1/4"	1 lb.	Front mount zinc hook	Chrome	51.00
	K-320C	4"	3/8"	2 5/16"	1 lb.	Front mount aluminum hook	Chrome	37.00
	K-320MS	4"	3/8"	2 5/16"	1 lb.	Front mount aluminum hook	Metallic Silver	32.00
	K-2088	5"	2"	1 7/16"	1/4 lb.	Front mount Anodized Aluminum coat hook	Bright Silver	56.00
	K-2121	5"	1 1/8"	1 3/8"	1/4 lb.	Anodized Aluminum coat hook	Bright Silver	59.00
	K-2123	4 3/4"	2 7/8"	1 7/8"	1/2 lb.	Front mount Anodized Aluminum coat hook	Silver Grey	60.00
	K-2124	4 1/2"	2 3/4"	1 13/16"	1/2 lb.	Front mount Anodized Aluminum coat hook	Silver Grey	75.00
	K-2130	4 1/4"	2"	1 7/8"	1/4 lb.	Front mount Anodized Aluminum coat hook	Silver Grey	49.00
	K-2187A	4"	1 1/4"	1 1/4"	1/4 lb.	Anodized Aluminum coat hook	Titanium or Metallic Silver	58.00

	K-2202A	5 3/8"	1 7/16"	1 5/8"	1/4 lb.	Anodized Aluminum coat hook	Titanium or Metallic Silver	62.00
	K-15	3 11/16"	3/4"	3 1/8"	1/4 lb.	Nylon	Dark Grey	24.00
	K-21S	5 7/8"	7/8"	3 7/8"	1/4 lb.	Aluminum Hook	<b>Silver Anodized</b>	60.00  <b>quick ship</b>
	K-21N	5 7/8"	7/8"	3 7/8"	1/4 lb.	Aluminum Hook, Powder coat finish	Black	58.00
	K-50C	1 1/4"	1 1/4"	1 9/16"	1/4 lb.	Zinc die cast knob	<b>Polished Chrome</b>	49.00  <b>quick ship</b>
	K-50BC	1 1/4"	1 1/4"	1 9/16"	1/4 lb.	Zinc die cast knob	<b>Brushed Chrome</b>	54.00  <b>quick ship</b>
	K-50N	1 1/4"	1 1/4"	1 9/16"	1/4 lb.	Zinc die cast knob, Powder coat finish	Black, White or Silver	46.00
	K-55C	1 3/8"	1 3/8"	2 13/16"	1/2 lb.	Zinc die cast knob	<b>Polished Chrome</b>	54.00  <b>quick ship</b>
	K-55BC	1 3/8"	1 3/8"	2 13/16"	1/2 lb.	Zinc die cast knob	<b>Brushed Chrome</b>	56.00  <b>quick ship</b>
	K-55N	1 3/8"	1 3/8"	2 13/16"	1/2 lb.	Zinc die cast knob, Powder coat finish	Black, White or Silver	53.00
	K-71C	2 1/4"	3/4"	1 3/4"	1/4 lb.	Steel hook	Chrome	11.00

K-220S	3 13/16"	7/8"	3 3/4"	1/2 lb.	Aluminum hook with door stop	Silver Anodized	116.00
							
K-230S	4 1/4"	7/8"	2 15/16"	1/2 lb.	Aluminum hook	Silver Anodized	81.00
							
K41ST	5 1/8"	3/4"	4"	1/2 lb.	Stainless steel hook	Stainless steel	30.00
							

# KROK HJH-10

## ADDITIONAL NOTES

Ships via UPS  
 Sample chips available.



LINE ART	MODEL	H	W	D	WEIGHT	DESCRIPTION	COLOR/FINISH	LIST PRICE
	KROK-HJH-10	4 7/8"	3 1/8"	2 1/2"	1 lb.	Front mount coat hook with back plate and matching plastic hook	White 9310, Black 9311, Light Blue 5324, Dark Blue 5311, Dark Green 6309, Red 3309 or Yellow 1304	150.00

## HOOK FINISH COLORS



Chromed

## ADDITIONAL NOTES

Ships via UPS



LINE ART	MODEL	H	W	D	WEIGHT	DESCRIPTION	COLOR/FINISH	LIST PRICE
	MIRAC-HK1	1"	3/4"	1 3/8"	1/4 lb.	Single coat Hook	Chromed Brass	53.00
	MIRAC-HK2	1"	3/4"	2 3/8"	1/4 lb.	Single coat Hook	Chromed Brass	63.00

# PC 550 SERIES



## ADDITIONAL NOTES

Ships via UPS

TSCA Title VI Compliant.

Sample chips available.





LINE ART	MODEL	H	W	D	WEIGHT	DESCRIPTION	COLOR/FINISH	LIST PRICE
	PC-550	6"	18"	3 9/16"	5 lbs.	Executive wall costumer with three polished chrome knobs.	<b>Oak, Walnut, Mahogany, Black</b> or <b>Victorian Cherry</b> Laminate with polished chrome knobs, matching wood hangers	230.00
								 <b>quick ship</b>

# PC SERIES PANEL/DOOR

## ADDITIONAL NOTES

Ships via UPS



LINE ART	MODEL	H	W	D	WEIGHT	DESCRIPTION	COLOR/FINISH	LIST PRICE
	PC-107H	4"	1"	3"	2 lbs.	Wall or door mounted costumer with 2 hangers	Charcoal Grey, Black	78.00
	PC-107H-CHROME	4"	1"	3"	2 lbs.	Wall or door mounted costumer with 2 hangers	Polished or Satin Chrome	105.00

# POINTO

## FINISH COLORS



Black



White



Mustard



Grey Beige

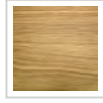

Matte Oak

## ADDITIONAL NOTES

Ships via UPS

Sample chips available.



LINE ART	MODEL	H	W	D	WEIGHT	DESCRIPTION	COLOR/FINISH	LIST PRICE
	POINTO-10	3"	round	2 3/8"	1 lb.	Round epoxy coated steel coat hook.	Matte White RAL 9003, Matte Grey Beige RAL 1019, Mustard Gloss RAL 1012, Satin Black RAL 9011	155.00
	POINTO-10W	3"	round	2 3/8"	1 lb.	Round epoxy coated steel coat hook with laminated matte oak front plate.	Matte White RAL 9003, Matte Grey Beige RAL 1019, Mustard Gloss RAL 1012 or Satin Black RAL 9011 Hook with Matte Oak front plate	205.00
	POINTO-20	3"	3"	2 3/8"	1 lb.	Square epoxy coated steel coat hook.	Matte White RAL 9003, Matte Grey Beige RAL 1019, Mustard Gloss RAL 1012, Satin Black RAL 9011	155.00
	POINTO-20W	3"	3"	2 3/8"	1 lb.	Square epoxy coated steel coat hook with laminated matte oak front plate.	Matte White RAL 9003, Matte Grey Beige RAL 1019, Mustard Gloss RAL 1012 or Satin Black RAL 9011 Hook with Matte Oak front plate	205.00



# S SERIES

## ADDITIONAL NOTES

Ships via UPS

SCH-33905 longer hook measures 3 1/8"; shorter hook measures 1 3/4"



LINE ART	MODEL	H	W	D	WEIGHT	DESCRIPTION	COLOR/FINISH	LIST PRICE
	SCH-44182	4 5/8"	3 1/8"	1 3/4"	.25 lbs.	Polished Chrome coat hook.	Polished Chrome	93.00
	SCH-33905	4 1/16"	1"	3 1/4"	.50 lbs.	Double coat hook with back plate.	Brushed stainless steel	133.00

# S-SERIES ANTIMICROBIAL

## FINISH COLORS

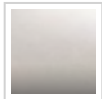



Satin Nickel

## ADDITIONAL NOTES

Ships via UPS



LINE ART	MODEL	H	W	D	WEIGHT	DESCRIPTION	COLOR/FINISH	LIST PRICE
	SCH-AM-Z327	2 9/16"	2 5/16"	1 1/16"	1 lb.	Zamak antimicrobial hook with concealed mounting.	Satin Nickel	95.00
	SCH-AM-Z313	2"	2"	1 5/8"	1 lb.	Zamak antimicrobial hook with concealed mounting.	Satin Nickel	95.00



# SHERWOOD

## ADDITIONAL NOTES

Ships via UPS



LINE ART	MODEL	H	W	D	WEIGHT	DESCRIPTION	COLOR/FINISH	LIST PRICE
	SW-M1	2 1/8"	3 7/8"	2 7/8"	1 lb.	Painted metal hook with one wood hook positioned horizontally.	Backplate and stem in White or Textured Black paint, with wood hook in Natural Beech, White or Black painted finish	78.00

# STAL

## FINISH COLORS



Sky White



Mineral Bronze



Stainless Steel

## ADDITIONAL NOTES

Ships via UPS.

Mounts directly to the wall with screws. Screws are included, mollies/toggle bolts not included.





Hook spacing allows for multiple units to be mounted side by side while maintaining consistent spacing.

Weight capacity of approximately 5lbs. per hook.

Stainless steel of STAL is Grade 430.

Sample chips available.



LINE ART	MODEL	H	W	D	WEIGHT	DESCRIPTION	COLOR/FINISH	LIST PRICE
	STAL-IN-P	5 3/16"	3 15/16"	3 11/16"	1 lb.	Painted steel wall mounted hook with 1 double pronged hook and a single hook above.	Sky White or Mineral Bronze	68.00
	STAL-IN-SS	5 3/16"	3 15/16"	3 11/16"	1 lb.	Stainless steel wall mounted hook with 1 double pronged hook and a single hook above.	Satin Stainless with Clear Coat	75.00
	STAL-1W-P	5 1/4"	4"	3 11/16"	3 lbs.	Painted steel wall mounted hook with 1 double pronged hook and a single hook above.	Sky White or Mineral Bronze	75.00
	STAL-1W-SS	5 1/4"	4"	3 11/16"	3 lbs.	Stainless steel wall mounted hook with 1 double pronged hook and a shelf above.	Satin Stainless with Clear Coat	83.00

# TERTIO H-K

## ADDITIONAL NOTES

Ships via UPS

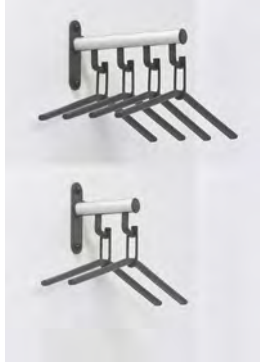

LINE ART	MODEL	H	W	D	WEIGHT	DESCRIPTION	COLOR/FINISH	LIST PRICE
	T-H10K	11 13/16"	17 11/16"	3 15/16"	2 lb.	Wall mounted coat rack with one dark grey plastic coat hanger.	Dark Grey with Satin Aluminum.	230.00
	T-H16K	11 13/16"	17 11/16"	6 5/16"	3 lb.	Wall mounted coat rack with two dark grey plastic coat hangers.	Dark Grey with Satin Aluminum.	285.00
	T-H22K	11 13/16"	17 11/16"	8 11/16"	3 lb.	Wall mounted coat rack with three dark grey plastic coat hangers.	Dark Grey with Satin Aluminum.	345.00
	T-H28K	11 13/16"	17 11/16"	11 1/16"	3 lb.	Wall mounted coat rack with four dark grey plastic coat hangers.	Dark Grey with Satin Aluminum.	395.00

# TREEHOOKED

## ADDITIONAL NOTES

Ships via UPS

Sample chips available.





LINE ART	MODEL	H	W	D	WEIGHT	DESCRIPTION	COLOR/FINISH	LIST PRICE
	TREE-1	10 5/8"	23 1/4"	1 3/16"	5 lbs.	Wall mounted coat rack. Can be used individually or in groups.	White 9310, Black 9311, Light Blue 5324, Dark Blue 5311, Dark Green 6309, Red 3309, Yellow 1304 or Metallic Grey 9306	325.00

# TUBULUS H

## ADDITIONAL NOTES

Ships via UPS



LINE ART	MODEL	H	W	D	WEIGHT	DESCRIPTION	COLOR/FINISH	LIST PRICE
	TUB-H10	6 11/16"	17 15/16"	3 15/16"	2 lb.	Coat hook with hanger.	Brushed Stainless hook with front in Polished Stainless Steel, hanger in varnished Beech with Brushed Stainless hook.	415.00
	TUB-H	1"	1 5/16"	2 1/16"	1 lb.	Coat hook	Brushed Stainless with front in Polished Stainless Steel.	180.00

# YIN UNDER TABLE HOOK

## ADDITIONAL NOTES

Ships via UPS

Sample chips available.



LINE ART	MODEL	H	W	D	WEIGHT	DESCRIPTION	COLOR/FINISH	LIST PRICE
	YIN-PH	3 3/8"	2 1/2"	1 5/8"	1 lbs.	Under table or counter hook to hold purses or bags.	White, Sand or Black	76.00

# COAT HOOK STRIPS

HOME → PRODUCTS → COAT HOOK STRIPS

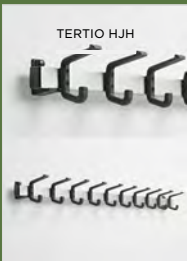
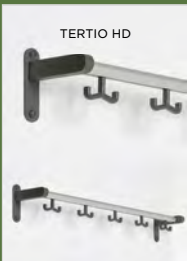
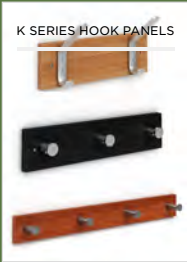

# ALOES MEW

## ADDITIONAL NOTES

Ships via UPS



LINE ART	MODEL	H	W	D	WEIGHT	DESCRIPTION	COLOR/FINISH	LIST PRICE
	MEW-1	2 3/4"	3 1/4"	3 3/16"	1 lb.	Single coat hook	Strip in White, Sand, Silver or Black, knob in Beech, Wengue, White, Black or Green	57.00
	MEW-2	2 3/4"	9 7/8"	3 3/16"	2 lbs.	Hook strip with two coat hooks.	Strip in White, Sand, Silver or Black, knob in Beech, Wengue, White, Black or Green	147.00
	MEW-3	2 3/4"	16 9/16"	3 3/16"	3 lbs.	Hook strip with three coat hooks.	Strip in White, Sand, Silver or Black, knob in Beech, Wengue, White, Black or Green	181.00
	MEW-5	2 3/4"	29 15/16"	3 3/16"	5 lbs.	Hook strip with five coat hooks.	Strip in White, Sand, Silver or Black, knob in Beech, Wengue, White, Black or Green	257.00

# CLIMB

## ADDITIONAL NOTES

Ships via UPS



LINE ART	MODEL	H	W	D	WEIGHT	DESCRIPTION	COLOR/FINISH	LIST PRICE
	CLIMB-10	1 15/16"	1 3/4"	2 1/2"	1/4 lb.	Anodized aluminum hook rail with single hook.	Silver Matte Aluminum	138.00
	CLIMB-20	1 15/16"	7 5/8"	2 1/2"	1/2 lb.	Anodized aluminum hook rail with two hooks.	Silver Matte Aluminum	198.00
	CLIMB-30	1 15/16"	13 3/4"	2 1/2"	1 1/2 lbs.	Anodized aluminum hook rail with three hooks.	Silver Matte Aluminum	270.00
	CLIMB-40	1 15/16"	19 7/16"	2 1/2"	1 3/4 lbs.	Anodized aluminum hook rail with four hooks.	Silver Matte Aluminum	341.00
	CLIMB-70	1 15/16"	37 3/16"	2 1/2"	3 lbs.	Anodized aluminum hook rail with seven hooks.	Silver Matte Aluminum	540.00

# K SERIES HOOK PANELS









## ADDITIONAL NOTES

Ships via UPS











Specify K-Series hooks separately.

TSCA Title VI Compliant.



LINE ART	MODEL	H	W	D	WEIGHT	DESCRIPTION	COLOR/FINISH	LIST PRICE
	2K-21S	4"	12"	4 5/8"	3 lbs.	Hook Panel with two K-21S hooks	Silver Anodized Aluminum Hooks with Laminate Panel in Oak, Walnut, Featherstone Grey, Black, Victorian Cherry or Mahogany	155.00
	3K-21S	4"	18"	4 5/8"	4 lbs.	Hook Panel with three K-21S hooks	Silver Anodized Aluminum Hooks with Laminate Panel in Oak, Walnut, Featherstone Grey, Black, Victorian Cherry or Mahogany	225.00
	4K-21S	4"	34"	4 5/8"	5 lbs.	Hook Panel with four K-21S hooks	Silver Anodized Aluminum Hooks with Laminate Panel in Oak, Walnut, Featherstone Grey, Black, Victorian Cherry or Mahogany	290.00
	2K-50C	4"	12"	2 5/16"	3 lbs.	Hook Panel with two K-50C hooks	Polished Chrome Zinc Die Cast Hooks with Laminate Panel in Oak, Walnut, Featherstone Grey, Black, Victorian Cherry or Mahogany	130.00
	3K-50C	4"	18"	2 5/16"	4 lbs.	Hook Panel with three K-50C hooks	Polished Chrome Zinc Die Cast Hooks with Laminate Panel in Oak, Walnut, Featherstone Grey, Black, Victorian Cherry or Mahogany	192.00
	4K-50C	4"	34"	2 5/16"	5 lbs.	Hook Panel with four K-50C hooks	Polished Chrome Zinc Die Cast Hooks with Laminate Panel in Oak, Walnut, Featherstone Grey, Black, Victorian Cherry or Mahogany	245.00
	2K-50BC	4"	12"	2 5/16"	3 lbs.	Hook Panel with two K-50BC hooks	Brushed Chrome Zinc Die Cast Hooks with Laminate Panel in Oak, Walnut, Featherstone Grey, Black, Victorian Cherry or Mahogany	139.00
	3K-50BC	4"	18"	2 5/16"	4 lbs.	Hook Panel with three K-50BC hooks	Brushed Chrome Zinc Die Cast Hooks with Laminate Panel in Oak, Walnut, Featherstone Grey, Black, Victorian Cherry or Mahogany	205.00



	4K-50BC	4"	34"	2 5/16"	5 lbs.	Hook Panel with four K-50BC hooks	Brushed Chrome Zinc Die Cast Hooks with Laminate Panel in Oak, Walnut, Featherstone Grey, Black, Victorian Cherry or Mahogany	265.00
	2K-55C	4"	12"	3 9/16"	3 lbs.	Hook Panel with two K-55C hooks	Polished Chrome Zinc Die Cast Hooks with Laminate Panel in Oak, Walnut, Featherstone Grey, Black, Victorian Cherry or Mahogany	140.00
	3K-55C	4"	18"	3 9/16"	4 lbs.	Hook Panel with three K-55C hooks	Polished Chrome Zinc Die Cast Hooks with Laminate Panel in Oak, Walnut, Featherstone Grey, Black, Victorian Cherry or Mahogany	203.00
	4K-55C	4"	34"	3 9/16"	5 lbs.	Hook Panel with four K-55C hooks	Polished Chrome Zinc Die Cast Hooks with Laminate Panel in Oak, Walnut, Featherstone Grey, Black, Victorian Cherry or Mahogany	264.00
	2K-55BC	4"	12"	3 9/16"	3 lbs.	Hook Panel with two K-55BC hooks	Brushed Chrome Zinc Die Cast Hooks with Laminate Panel in Oak, Walnut, Featherstone Grey, Black, Victorian Cherry or Mahogany	145.00
	3K-55BC	4"	18"	3 9/16"	4 lbs.	Hook Panel with three K-55BC hooks	Brushed Chrome Zinc Die Cast Hooks with Laminate Panel in Oak, Walnut, Featherstone Grey, Black, Victorian Cherry or Mahogany	210.00
	4K-55BC	4"	34"	3 9/16"	5 lbs.	Hook Panel with four K-55BC hooks	Brushed Chrome Zinc Die Cast Hooks with Laminate Panel in Oak, Walnut, Featherstone Grey, Black, Victorian Cherry or Mahogany	274.00
	12" Panel For 2 hooks	4"	12"	3/4"	3 lbs. w/hooks	High pressure laminate panel	Oak, Walnut, Featherstone Grey, Black, Victorian Cherry or Mahogany	37.00
	18" Panel For 3 hooks	4"	18"	3/4"	4 lbs. w/hooks	High pressure laminate panel	Oak, Walnut, Featherstone Grey, Black, Victorian Cherry or Mahogany	50.00
	34" Panel For 4 hooks	4"	34"	3/4"	5 lbs. w/hooks	High pressure laminate panel	Oak, Walnut, Featherstone Grey, Black, Victorian Cherry or Mahogany	58.00

# KOBE

## ADDITIONAL NOTES

Ships via UPS.



LINE ART	MODEL	H	W	D	WEIGHT	DESCRIPTION	COLOR/FINISH	LIST PRICE
	KOBE-1	3 3/16"	3 13/16"	2 3/4"	1 lb.	Hook strip with single coat hook.	Black strip with ABS hook in White, Black, Silver or Red	56.00
	KOBE-2	3 3/16"	10 7/16"	2 3/4"	2 lb.	Hook strip with two coat hooks.	Black strip with ABS hook in White, Black, Silver or Red	80.00
	KOBE-3	3 3/16"	17 1/8"	2 3/4"	3 lb.	Hook strip with three coat hooks.	Black strip with ABS hook in White, Black, Silver or Red	122.00
	KOBE-5	3 3/16"	30 1/2"	2 3/4"	5 lb.	Hook strip with five coat hooks.	Black strip with ABS hook in White, Black, Silver or Red	165.00

# KROK BOX

## ADDITIONAL NOTES

Ships via UPS

Sample chips available.



LINE ART	MODEL	H	W	D	WEIGHT	DESCRIPTION	COLOR/FINISH	LIST PRICE
	KROK BOX	4 3/4"	19 3/4"	5 3/8"	5 lbs.	Textured painted steel storage box with four matching plastic coat hooks. Mounts to wall.	Black 9311, White 9310, Light Blue 5324, Dark Blue 5311, Red 3309, Yellow 1304 or Dark Green 6308	545.00



# KROK HJH

## ADDITIONAL NOTES

Ships via UPS

Sample chips available.



LINE ART	MODEL	H	W	D	WEIGHT	DESCRIPTION	COLOR/FINISH	LIST PRICE
	KROK HJH-30	4 7/8"	11 13/16"	2 1/4"	2 lbs.	Textured painted steel hook strip with two matching plastic coat hooks.	Black 9311, White 9310, Light Blue 5324, Dark Blue 5311, Red 3309, Yellow 1304 or Dark Green 6309	170.00
	KROK HJH-60	4 7/8"	23 5/8"	2 1/4"	4 lbs.	Textured painted steel hook strip with five matching plastic coat hooks.	Black 9311, White 9310, Light Blue 5324, Dark Blue 5311, Red 3309, Yellow 1304 or Dark Green 6309	280.00
	KROK HJH-90	4 7/8"	35 7/16"	2 1/4"	6 lbs.	Textured painted steel hook strip with eight matching plastic coat hooks.	Black 9311, White 9310, Light Blue 5324, Dark Blue 5311, Red 3309, Yellow 1304 or Dark Green 6309	380.00

# MIRAC

## RAIL FINISH COLORS



Aluminum RAL  
9006

## HOOK FINISH COLORS



Chromed

## ADDITIONAL NOTES

Ships via UPS

LINE ART	MODEL	H	W	D	WEIGHT	DESCRIPTION	COLOR/FINISH	LIST PRICE
	MIRAC-50	1 5/8"	19 11/16"	3 1/8"	2 lbs.	Aluminum hook rail with five chromed brass hooks.	Aluminum Ral 9006 rail with Chrome hooks	390.00





# NOMIS

## ADDITIONAL NOTES

Ships via UPS.



LINE ART	MODEL	H	W	D	WEIGHT	DESCRIPTION	COLOR/FINISH	LIST PRICE
	NOMIS-3	3 7/8"	14 3/4"	3 3/8"	3 lbs.	Painted metal hook strip with 3 integrated hooks and wood mounting backplate.	Black, White	385.00
	NOMIS-8	3 7/8"	39 3/8"	3 3/8"	8 lbs.	Painted metal hook strip with 8 integrated hooks and wood mounting backplate.	Black, White	570.00

# ONA

## FINISH COLORS



Oak



Walnut



White RAL 9002

## ADDITIONAL NOTES

Ships via UPS

Ona mounts directly to the wall.

TSCA Title VI Compliant.



LINE ART	MODEL	H	W	D	WEIGHT	DESCRIPTION	COLOR/FINISH	LIST PRICE
	ONA	7 1/2"	38 3/16"	5 7/8"	5 lb.	Laminated wooden hook strip.	Oak, Grey White RAL 9002 or Walnut	735.00

# SECOND TREE

## FINISH COLORS



Matte Oak



Matte White RAL 9003

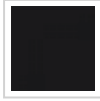

Satin Black RAL 9011



Textured Forge Grey

## ADDITIONAL NOTES

Ships via UPS.

SECOND TREE utilizes a wall mounted plate that the hook strip slides into.

Sample chips available.



LINE ART	MODEL	H	W	D	WEIGHT	DESCRIPTION	COLOR/FINISH	LIST PRICE
	SECOND TREE-3	5 1/8"	19"	4 3/16"	4 lbs.	Painted steel coat hook strip with three oak wood hooks.	Satin Black RAL 9011, Textured Forge Grey or Matte White RAL 9003 with Oak wood hooks.	425.00



# SEI

## ADDITIONAL NOTES

Ships via UPS

Sample chips available.



LINE ART	MODEL	H	W	D	WEIGHT	DESCRIPTION	COLOR/FINISH	LIST PRICE
	SEI-10	7 1/16"	9 13/16"	2 15/16"	4 lbs.	Hook strip with two epoxy coated steel hat and coat hooks	Black 9011, Metallic Grey 9006 or White 9010	435.00
	SEI-20	7 1/16"	17 11/16"	2 15/16"	6 lbs.	Hook strip with three epoxy coated steel hat and coat hooks.	Black 9011, Metallic Grey 9006 or White 9010	545.00



# SHERWOOD

## ADDITIONAL NOTES

Ships via UPS

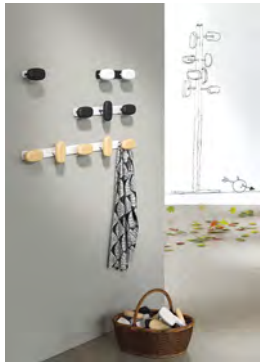
Hook positions are fixed.



LINE ART	MODEL	H	W	D	WEIGHT	DESCRIPTION	COLOR/FINISH	LIST PRICE
	SW-M2	2 1/8"	10 5/8"	2 7/8"	1 lb.	Painted metal hook strip with two wood hooks positioned horizontally.	Backplate and stem in White or Textured Black paint, with two wood hooks in Natural Beech, White or Black painted finish	118.00
	SW-M3	3 7/8"	17 5/16"	2 7/8"	2 lbs.	Painted metal hook strip with three wood hooks. Center hook is positioned vertically, two outer hooks are positioned horizontally.	Backplate and stem in White or Textured Black paint with three wood hooks in Natural Beech, White or Black painted finish.	179.00
	SW-M5	3 7/8"	30 5/8"	2 7/8"	4 lbs.	Painted metal hook strip with five wood hooks. Hooks alternate between horizontal and vertical positioning.	Backplate and stem in White or Textured Black paint with five wood hooks in Natural Beech, White or Black painted finish.	285.00

# SLIDE W

## ADDITIONAL NOTES

---

Ships via UPS

Hooks can be adjusted from side to side and up and down.

Sample chips available.



LINE ART	MODEL	H	W	D	WEIGHT	DESCRIPTION	COLOR/FINISH	LIST PRICE
	SLIDE W2	50"	4 11/16"	7 3/4"	8 lbs.	Wall mounted coat tree with painted metal base and post with 5 white plastic hooks.	Base and post in White textured paint	510.00

---











# STAINLESS STEEL

## ADDITIONAL NOTES

Ships via UPS



LINE ART	MODEL	H	W	D	WEIGHT	DESCRIPTION	COLOR/FINISH	LIST PRICE
	K-41ST	5 1/8"	3/4"	4"	1/2 lb.	Single hook	<b>Stainless Steel</b>	30.00  <b>quick ship</b>
	2K-41ST	4"	12"	4 1/4"	3 lbs.	Two hook panel	<b>Stainless Steel</b>	91.00  <b>quick ship</b>
	3K-41ST	4"	18"	4 1/4"	4 lbs.	Three hook panel	<b>Stainless Steel</b>	127.00  <b>quick ship</b>
	6K-41ST	4"	36"	4 1/4"	6 lbs.	Six hook panel	<b>Stainless Steel</b>	187.00  <b>quick ship</b>

# STAL

## FINISH COLORS



Sky White



Mineral Bronze



Stainless Steel

## ADDITIONAL NOTES

Ships via UPS.

Mounts directly to the wall with screws. Screws are included, mollies/toggle bolts not included.

Hook spacing allows for multiple units to be mounted side by side while maintaining consistent spacing.

Weight capacity of approximately 5lbs. per hook.

Stainless steel of STAL is Grade 430.

Sample chips available.

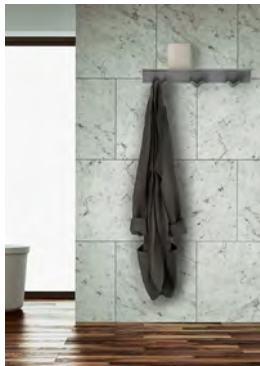

LINE ART	MODEL	H	W	D	WEIGHT	DESCRIPTION	COLOR/FINISH	LIST PRICE
	STAL-IN-P	5 3/16"	3 15/16"	3 11/16"	1 lb.	Painted steel wall mounted hook with 1 double pronged hook and a single hook above.	Sky White or Mineral Bronze	68.00
	STAL-IN-SS	5 3/16"	3 15/16"	3 11/16"	1 lb.	Stainless steel wall mounted hook with 1 double pronged hook and a single hook above.	Satin Stainless with Clear Coat	75.00
	STAL-1W-P	5 1/4"	4"	3 11/16"	3 lbs.	Painted steel wall mounted hook with 1 double pronged hook and a single shelf above.	Sky White or Mineral Bronze	75.00
	STAL-1W-SS	5 1/4"	4"	3 11/16"	3 lbs.	Stainless steel wall mounted hook with 1 double pronged hook and a single shelf above.	Satin Stainless with Clear Coat	83.00
	STAL-3-P	5 1/4"	30"	3 11/16"	5 lbs.	Painted steel wall mounted hook strip with 3 double pronged hooks and a shelf above.	Sky White or Mineral Bronze	172.00
	STAL-3-SS	5 1/4"	30"	3 11/16"	5 lbs.	Stainless steel wall mounted hook strip with 3 double pronged hooks and a shelf above.	Satin Stainless with Clear Coat	225.00
	STAL-4-P	5 1/4"	40"	3 11/16"	6 lbs.	Painted steel wall mounted hook strip with 4 double pronged hooks and a shelf above.	Sky White or Mineral Bronze	190.00
	STAL-4-SS	5 1/4"	40"	3 11/16"	6 lbs.	Stainless steel wall mounted hook strip with 4 double pronged hooks and a shelf above.	Satin Stainless with Clear Coat	248.00

STAL-5-P	5 1/4"	50"	3 11/16"	7 lbs.	Painted steel wall mounted hook strip with 5 double pronged hooks and a shelf above.	Sky White or Mineral Bronze	271.00
STAL-5-SS	5 1/4"	50"	3 11/16"	7 lbs.	Stainless steel wall mounted hook strip with 5 double pronged hooks and a shelf above.	Satin Stainless with Clear Coat	317.00

## STICKS HJH

### ADDITIONAL NOTES

Ships via UPS







LINE ART	MODEL	H	W	D	WEIGHT	DESCRIPTION	COLOR/FINISH	LIST PRICE
	STICKS-HJH-30	4 15/16"	11 13/16"	2 15/16"	1 lb.	Hook rail with two white plastic hat and coat hooks.	Varnished Natural Oak rail	310.00
	STICKS-HJH-60	4 15/16"	23 5/8"	2 15/16"	2 lbs.	Hook rail with five white plastic hat and coat hooks.	Varnished Natural Oak rail	475.00
	STICKS-HJH-90	4 15/16"	35 7/16"	2 15/16"	3 lbs.	Hook rail with eight white plastic hat and coat hooks.	Varnished Natural Oak rail	625.00

# TERTIO H

## ADDITIONAL NOTES

Ships via UPS





LINE ART	MODEL	H	W	D	WEIGHT	DESCRIPTION	COLOR/FINISH	LIST PRICE
	T-H-30	3 1/8"	11 13/16"	3 1/8"	2 lbs.	Round hook rail with three grey plastic hooks.	Anodized Aluminum strip, Dark Grey supports	120.00
	T-H-60	3 1/8"	23 5/8"	3 1/8"	3 lbs.	Round hook rail with six grey plastic hooks.	Anodized Aluminum strip, Dark Grey supports	200.00
	T-H-90	3 1/8"	35 7/16"	3 1/8"	3 lbs.	Round hook rail with nine grey plastic hooks.	Anodized Aluminum strip, Dark Grey supports	285.00
	T-H-120	3 1/8"	47 1/4"	3 1/8"	4 lbs.	Round hook rail with twelve grey plastic hooks.	Anodized Aluminum strip, Dark Grey supports	350.00

# TERTIO HA

## ADDITIONAL NOTES

Ships via UPS



LINE ART	MODEL	H	W	D	WEIGHT	DESCRIPTION	COLOR/FINISH	LIST PRICE
	T-HA-60	6 5/16"	23 5/8"	5 7/8"	5 lbs.	Hook rail with six grey plastic hooks.	Anodized Aluminum strip, Dark Grey supports	300.00
	T-HA-90	6 5/16"	35 7/16"	5 7/8"	7 lbs.	Hook rail with nine grey plastic hooks.	Anodized Aluminum strip, Dark Grey supports	345.00
	T-HA-120	6 5/16"	47 1/4"	5 7/8"	8 lbs.	Hook rail with twelve grey plastic hooks.	Anodized Aluminum strip, Dark Grey supports	395.00

# TERTIO HD

## ADDITIONAL NOTES

Ships via UPS



LINE ART	MODEL	H	W	D	WEIGHT	DESCRIPTION	COLOR/FINISH	LIST PRICE
	T-HD-60	6 5/16"	23 5/8"	5 7/8"	5 lbs.	Hook rail with three double prong grey plastic hooks.	Anodized Aluminum strip, Dark Grey supports	300.00
	T-HD-90	6 5/16"	35 7/16"	5 7/8"	7 lbs.	Hook rail with four double prong grey plastic hooks.	Anodized Aluminum strip, Dark Grey supports	345.00
	T-HD-120	6 5/16"	47 1/4"	5 7/8"	8 lbs.	Hook rail with six double prong grey plastic hooks.	Anodized Aluminum strip, Dark Grey supports	395.00

# TERTIO HJH

## ADDITIONAL NOTES

Ships via UPS







LINE ART	MODEL	H	W	D	WEIGHT	DESCRIPTION	COLOR/FINISH	LIST PRICE
	T-HJH-30	3 3/4"	11 13/16"	4 3/4"	2 lbs.	Hook rail with three grey plastic hat & coat hooks.	Anodized Aluminum strip, Dark Grey supports	125.00
	T-HJH-60	3 3/4"	23 5/8"	4 3/4"	3 lbs.	Hook rail with six grey plastic hat & coat hooks.	Anodized Aluminum strip, Dark Grey supports	250.00
	T-HJH-90	3 3/4"	35 7/16"	4 3/4"	4 lbs.	Hook rail with nine grey plastic hat & coat hooks.	Anodized Aluminum strip, Dark Grey supports	345.00
	T-HJH-120	3 3/4"	47 1/4"	4 3/4"	5 lbs.	Hook rail with twelve grey plastic hat & coat hooks.	Anodized Aluminum strip, Dark Grey supports	415.00

# YIN MYIW

## ADDITIONAL NOTES

Ships via UPS

Sample chips available.

LINE ART	MODEL	H	W	D	WEIGHT	DESCRIPTION	COLOR/FINISH	LIST PRICE
	MYIW-1	2 1/4"	3"	2"	2 lbs.	Hook strip with single coat hook.	White, Sand, Clay, Silver, Black, Red, or Chocolate	104.00
	MYIW-2	2 1/4"	9 13/16"	2"	3 lbs.	Hook strip with two coat hooks.	White, Sand, Clay, Silver, Black, Red, or Chocolate	138.00
	MYIW-3	2 1/4"	15 9/16"	2"	4 lbs.	Hook strip with three coat hooks.	White, Sand, Clay, Silver, Black, Red, or Chocolate	175.00
	MYIW-5	2 1/4"	32"	2"	6 lbs.	Hook strip with five coat hooks.	White, Sand, Clay, Silver, Black, Red, or Chocolate	260.00

# COAT TREES

HOME → PRODUCTS → COAT TREES





# ALOES MET

## ADDITIONAL NOTES

Ships via UPS

Sample chips available.





LINE ART	MODEL	H	W	D	WEIGHT	DESCRIPTION	COLOR/FINISH	LIST PRICE
	MET	67"	15"	round	20 lbs.	Coat tree with steel frame and 6 knobs in Beech, Wengue, White, Black or Green with umbrella retainer.	Frame in Black, <b>Silver</b> , White, Sand or Chocolate	560.00  <b>quick ship</b>

# BAMBU

## ADDITIONAL NOTES

Ships via UPS



LINE ART	MODEL	H	W	D	WEIGHT	DESCRIPTION	COLOR/FINISH	LIST PRICE
	BAMBU-01	67 11/16"	14 3/4"	round	26 lbs.	Coat tree with painted aluminum post, painted steel base and 9 molded plastic hooks.	Grey Ral 7022 or Grey White Ral 9002.	995.00
	BAMBU-03	67 11/16"	14 3/4"	round	26 lbs.	Coat tree with painted aluminum post, painted steel base, umbrella holder and 6 molded plastic hooks.	Grey Ral 7022 or Grey White Ral 9002.	1,135.00



# BRANCH

## FRAME FINISH COLORS



Anodized Aluminum



White

## BASE & HOOK FINISH COLORS



Textured Black



Textured Forge Grey



White

## ADDITIONAL NOTES

Ships via UPS

Sample chips available.



LINE ART	MODEL	H	W	D	WEIGHT	DESCRIPTION	COLOR/FINISH	LIST PRICE
	BRANCH-01	74 7/8"	12 7/8"	12 7/8"	23 lbs.	Coat tree with 5 painted steel hooks, square base and painted or anodized aluminum post.	Base and hooks in White Gloss, Satin Black RAL 9011 or Textured Forge Grey with post in Anodized Aluminum or White Gloss	925.00

# HELIX

## FRAME FINISH COLORS



Anodized Aluminum



White

## BASE & HOOK FINISH COLORS



Textured Black



Textured Forge Grey



White

## ADDITIONAL NOTES

Ships via UPS

Sample chips available.



LINE ART	MODEL	H	W	D	WEIGHT	DESCRIPTION	COLOR/FINISH	LIST PRICE
	HELIX-01	70"	12 3/4"	round	20 lbs.	Coat tree with painted steel base and 6 painted steel hooks and painted aluminum post.	Base and hooks in White Gloss, Satin Black RAL 9011 or Textured Forge Grey with post in Anodized Aluminum or White Gloss	995.00
	HELIX-JR	36 5/8"	8 9/16"	round	10 lbs.	Junior height unit for coat/purse/bag with painted steel base and 3 painted steel hooks and painted aluminum post.	Base, hooks and post in White Gloss, Satin Black RAL 9011 or Textured Forge Grey.	595.00

# HULOT

## ADDITIONAL NOTES

Ships via UPS



LINE ART	MODEL	H	W	D	WEIGHT	DESCRIPTION	COLOR/FINISH	LIST PRICE
	HULOT	68 7/8"	18 7/8"	18 7/8"	26 lbs.	Coat tree with molded plastic hooks and cast iron base.	Grey White Ral 9002 or Grey Ral 7022	985.00

# KOBE

## ADDITIONAL NOTES

Ships via UPS.



LINE ART	MODEL	H	W	D	WEIGHT	DESCRIPTION	COLOR/FINISH	LIST PRICE
	KOBE PP	64 1/4"	14 3/4"	round	20 lbs.	Metal coat tree with 6 ABS hooks and umbrella ring. Post color can be different than base, umbrella ring and hook support.	Post, base, umbrella ring and hook support in Silver, White, Black, Sand or Chocolate. ABS hooks in White, Black, Silver or Red.	560.00

# MIRAC

## POST FINISH COLORS



Silver

## HOOK FINISH COLORS



Chromed

## BASE FINISH COLORS



Grey Cast Iron

## ADDITIONAL NOTES

Ships via UPS



LINE ART	MODEL	H	W	D	WEIGHT	DESCRIPTION	COLOR/FINISH	LIST PRICE
	MIRAC-10	75 3/8"	11 13/16"	round	27 lbs.	Coat tree with 10 chrome knobs and cast iron base. Can be used with Mirac 6 plastic hangers.	Aluminum Ral 9006 post with Anthracite Grey Ral 7022 cast iron base and chrome hooks.	1,345.00

# NANAME

## FINISH COLORS



Matte White



Textured Forge Grey



Black

## ADDITIONAL NOTES

Ships via common carrier.

NANAME holds 3 coats.

Sample chips available.



LINE ART	MODEL	H	W	D	WEIGHT	DESCRIPTION	COLOR/FINISH	LIST PRICE
	NANAME	74 1/2"	12 3/4"	round	18 lbs.	Painted steel coat tree with round base.	Matte White RAL 9003, Satin Black RAL 9011 or Textured Forge Grey	1,465.00

# PALADINO

## ADDITIONAL NOTES

Ships via UPS



LINE ART	MODEL	H	W	D	WEIGHT	DESCRIPTION	COLOR/FINISH	LIST PRICE
	PALADINO	68 1/2"	13 11/16"	round	12 lbs.	Coat tree in epoxy coated steel with round base and dark grey plastic hooks.	Dark Grey	520.00

# SAGITTA

## ADDITIONAL NOTES

Ships via UPS



LINE ART	MODEL	H	W	D	WEIGHT	DESCRIPTION	COLOR/FINISH	LIST PRICE
	SAGITTA	66 15/16"	17 11/16"	round	14 lbs.	Coat tree with umbrella holder and 4 hangers in dark grey plastic.	Dark Grey with Satin Aluminum	1,065.00

# SECOND TREE

## COLUMN & BASE FINISH COLORS



Textured Black



Textured Forge Grey



Matte White

## ADDITIONAL NOTES

Ships via common carrier.

Sample chips available.



LINE ART	MODEL	H	W	D	WEIGHT	DESCRIPTION	COLOR/FINISH	LIST PRICE
	SECOND TREE	74 3/4"	17 3/4"	17 3/4"	19 lbs.	Painted steel coat tree with five oak wood hooks.	Satin Black Ral 9011, Textured Forge Grey or Matte White Ral 9003 with Oak wood hooks.	1,525.00

# SHERWOOD

## ADDITIONAL NOTES

Ships via common carrier.

Hook positions are fixed - three vertically, three horizontally.

LINE ART	MODEL	H	W	D	WEIGHT	DESCRIPTION	COLOR/FINISH	LIST PRICE
	SW-B6	64 5/8"	13 3/8"	13 3/8"	16 lbs.	Coat tree with lower half of post and base in steel. Upper half of post in wood with 6 wood hooks.	Top portion of post in Natural Beech with bottom half of post and base painted in White or Textured Black. Wood hooks in Natural Beech, White or Black paint finish.	769.00

# SLIDE

## ADDITIONAL NOTES



Ships via common carrier.

Hooks can be adjusted from side to side and up and down.

Slide hooks can be purchased separately

Sample chips available.



LINE ART	MODEL	H	W	D	WEIGHT	DESCRIPTION	COLOR/FINISH	LIST PRICE
	SLIDE G1	67 5/8"	11 3/4"	round	21 lbs.	Coat tree with painted metal base and post and six white plastic hooks	Base and post in White textured paint	520.00
	SLIDE G2	67 5/8"	21 1/2"	9 7/8"	30 lbs.	Coat tree with metal base and two posts each containing six white plastic hooks	Base and post in White textured paint	895.00
	SLIDE G3	67 5/8"	33 3/8"	9 7/8"	45 lbs.	Coat tree with metal base and three posts each containing six white plastic hooks	Base and post in White textured paint	1,295.00



# TAIGA

## FINISH COLORS



Grey RAL 7022





White RAL 9002

## ADDITIONAL NOTES

Ships via UPS



LINE ART	MODEL	H	W	D	WEIGHT	DESCRIPTION	COLOR/FINISH	LIST PRICE
	TAIGA-01	69 3/4"	13 3/4"	round	26 lbs.	Coat tree with painted steel base, aluminum painted post and 8 plastic coat hooks. Can be used with Mirac-6 plastic hangers.	Grey White Ral 9002 or Grey Ral 7022	820.00
	TAIGA-03	69 3/4"	13 3/4"	round	28 lbs.	Coat tree with painted steel base, aluminum painted post, umbrella ring and 6 plastic hooks. Can be used with Mirac-6 plastic hangers.	Grey White Ral 9002 or Grey Ral 7022	985.00

## FINISH COLORS



Red



White



Black

## ADDITIONAL NOTES

Ships via UPS

Sample chips available.



LINE ART	MODEL	H	W	D	WEIGHT	DESCRIPTION	COLOR/FINISH	LIST PRICE
	YIN	62 1/2"	13 3/8"	round	15 lbs.	Metal coat tree with 5 hooks and umbrella stand.	Red, Black or White	560.00

# COAT RACKS

HOME → PRODUCTS → COAT RACKS

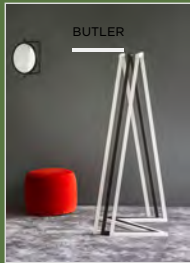



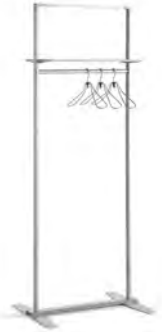

# ARNAGE

## ADDITIONAL NOTES

Arnage PC-M ships via UPS; Arnage PC-P/PT ship via common carrier.



LINE ART	MODEL	H	W	D	WEIGHT	DESCRIPTION	COLOR/FINISH	LIST PRICE
	ARNAGE PC-M	11 1/2"	20 1/16"	14"	8 lbs.	Steel wall mounted coatrack with hanger rod	White, Black, Sand or Silver	515.00
	ARNAGE PC-P	66 15/16"	28 3/16"	21 5/8"	35 lbs.	Steel floor rack with hanger rod	White, Black, Silver or Sand.	1,195.00
	ARNAGE PC-PT	72 1/4"	28 3/16"	21 5/8"	40 lbs.	Steel floor rack with hanger rod and shelf	White, Black, Silver or Sand.	1,295.00
	ARNAGE SR	3"	28 3/16"	21 5/8"	10 lbs.	Optional caster base for use on PC-P and PC-PT units	White, Black, Silver or Sand.	310.00

# BUTLER

## FINISH COLORS



Black



White



## ADDITIONAL NOTES

Ships via common carrier.

Multiple units can be stored side by side efficiently with the unique zig-zag base.

Pair BUTLER with TUBULUS, UNIVERSUM or any standard 1 1/2" open hook hangers.

Sample chips available.

LINE ART	MODEL	H	W	D	WEIGHT	DESCRIPTION	COLOR/FINISH	LIST PRICE
	BUTLER	59 1/16"	21 5/8"	18 7/8"	14 lbs.	Painted steel coat rack with unique zig-zag base.	White or Black	855.00
	BUTLER-BASE	1/2"	21 3/4"	19 1/4"	8 lbs.	Painted steel base plate to store bags or shoes on Butler Coat Rack.	White or Black	360.00
	BUTLER-HOOKS	4 3/8"	1 1/4"	1 1/2"	1/2 lb.	Set of 3 chrome hanging hooks for Butler Coat Rack.	White or Black	145.00

# DS SERIES

## FINISH COLORS



Black



Medium Grey



Sandstone

## ADDITIONAL NOTES

Single sided DS units ("DSF") ship via UPS; double sided DS units ("DDF") ship via common carrier.

Hanger style units accept standard 1-1/2" open hangers, CL closed loop hangers or R1.5 receptacles with MG17PP T-Top or MG17B ball top hangers.

A maximum of 5 hangers per foot are recommended on all DS Series floor racks.













Some hanger bar deflection is possible on 5ft. units.

Designer Series racks require use of CBA caster base assembly which includes CST4 2" casters.

Sample chips available.



LINE ART	MODEL	H	W	D	WEIGHT	DESCRIPTION	COLOR/FINISH	LIST PRICE
	DSF-3H	61"	36"	18 3/8"	36 lbs	Hanger Style Single Sided Floor Rack-All powder-coated steel construction with 1" stainless steel hanger bar Capacity-5 hangers per foot.	Medium Grey, Sandstone or Black	575.00  quick ship
	DSF-4H	61"	48"	18 3/8"	40 lbs	Hanger Style Single Sided Floor Rack-All powder-coated steel construction with 1" stainless steel hanger bar Capacity-5 hangers per foot.	Medium Grey, Sandstone or Black	612.00  quick ship
	DSF-5H	61"	60"	18 3/8"	45 lbs	Hanger Style Single Sided Floor Rack-All powder-coated steel construction with 1" stainless steel hanger bar Capacity-5 hangers per foot.	Medium Grey, Sandstone or Black	666.00  quick ship
	DSF-3HA	61"	36"	18 3/8"	36 lbs	Hanger Style Single Sided Floor Rack-Powder-coated steel construction with clear anodized aluminum shelf bars and 1" stainless steel hanger bar Capacity-5 hangers per foot.	Medium Grey, Sandstone or Black frames each with Aluminum Shelf Tubes	651.00
	DSF-4HA	61"	48"	18 3/8"	40 lbs	Hanger Style Single Sided Floor Rack-Powder-coated steel construction with clear anodized aluminum shelf bars and 1" stainless steel hanger bar Capacity-5 hangers per foot.	Medium Grey, Sandstone or Black frames each with Aluminum Shelf Tubes	705.00
	DSF-5HA	61"	60"	18 3/8"	45 lbs	Hanger Style Single Sided Floor Rack-Powder-coated steel construction with clear anodized aluminum shelf bars and 1" stainless steel hanger bar Capacity-5 hangers per foot.	Medium Grey, Sandstone or Black frames each with Aluminum Shelf Tubes	767.00
	DDF-3H	61"	36"	27 3/8"	47 lbs	Hanger Style Double Sided Floor Rack-All powder-coated steel construction with 1" stainless steel hanger bar Capacity-5 hangers per foot.	Medium Grey, Sandstone or Black	886.00

	DDF-4H	61"	48"	27 3/8"	53 lbs	Hanger Style Double Sided Floor Rack-All powder-coated steel construction with 1" stainless steel hanger bar Capacity-5 hangers per foot.	Medium Grey, Sandstone or Black	947.00
	DDF-5H	61"	60"	27 3/8"	59 lbs	Hanger Style Double Sided Floor Rack-All powder-coated steel construction with 1" stainless steel hanger bar Capacity-5 hangers per foot.	Medium Grey, Sandstone or Black	1,021.00
	DDF-3HA	61"	36"	27 3/8"	47 lbs	Hanger Style Double Sided Floor Rack-Powder-coated steel construction with clear anodized aluminum shelf bars and 1" stainless steel hanger bar Capacity-5 hangers per foot.	Medium Grey, Sandstone or Black frames each with Aluminum Shelf Tubes	1,021.00
	DDF-4HA	61"	48"	27 3/8"	53 lbs	Hanger Style Double Sided Floor Rack-Powder-coated steel construction with clear anodized aluminum shelf bars and 1" stainless steel hanger bar Capacity-5 hangers per foot.	Medium Grey, Sandstone or Black frames each with Aluminum Shelf Tubes	1,097.00
	DDF-5HA	61"	60"	27 3/8"	59 lbs	Hanger Style Double Sided Floor Rack-Powder-coated steel construction with clear anodized aluminum shelf bars and 1" stainless steel hanger bar Capacity-5 hangers per foot.	Medium Grey, Sandstone or Black frames each with Aluminum Shelf Tubes	1,169.00
	DSF-3K	61"	36"	18 3/8"	38 lbs	Hook Style Single Sided Floor Rack-All powder-coated steel construction with 6x Charcoal Grey K-73 triple prong hooks.	Medium Grey Sandstone Black each with Charcoal Grey K-73 Hooks	642.00
	DSF-4K	61"	48"	18 3/8"	42 lbs	Hook Style Single Sided Floor Rack-All powder-coated steel construction with 8x Charcoal Grey K-73 triple prong hooks.	Medium Grey Sandstone Black each with Charcoal Grey K-73 Hooks	680.00
	DSF-5K	61"	60"	18 3/8"	47 lbs	Hook Style Single Sided Floor Rack-All powder-coated steel construction with 12x Charcoal Grey K-73 triple prong hooks.	Medium Grey Sandstone Black each with Charcoal Grey K-73 Hooks	726.00
	DSF-3KA	61"	36"	18 3/8"	38 lbs	Hook Style Single Sided Floor Rack-Powder-coated steel construction with clear anodized aluminum shelf bars and 6x Charcoal Grey K-73 triple prong hooks.	Medium Grey, Sandstone or Black frames each with aluminum Shelf Tubes and Charcoal Grey K-73 Hooks	726.00
	DSF-4KA	61"	48"	18 3/8"	42 lbs	Hook Style Single Sided Floor Rack-Powder-coated steel construction with clear anodized aluminum shelf bars and 8x Charcoal Grey K-73 triple prong hooks.	Medium Grey, Sandstone or Black frames each with Aluminum Shelf Tubes and Charcoal Grey K-73 Hooks	782.00
	DSF-5KA	61"	60"	18 3/8"	47 lbs	Hook Style Single Sided Floor Rack-Powder-coated steel construction with clear anodized aluminum shelf bars and 12x Charcoal Grey K-73 triple prong hooks.	Medium Grey, Sandstone or Black frames each with Aluminum Shelf Tubes and Charcoal Grey K-73 Hooks	844.00
	CBA-36	Add 3" to height of rack	34"	N/A	9 lbs.	Set of 4-2 1/2" Double wheel locking casters with Spacer Bar and Shock Bracing. For Models DSF-3 and DDF-3 use CBA-36. Specify whether a Single (DSF) or Double(DDF) is needed.	Medium Grey, Sandstone, Black with Black Casters	166.00
	CBA-48	Add 3" to height of rack	46"	N/A	10 lbs.	Set of 4-2 1/2" Double wheel locking casters with Spacer Bar and Shock Bracing. For Models DSF-4 and DDF-4 use CBA-48. Specify whether a Single (DSF) or Double(DDF) is needed.	Medium Grey Sandstone Black with Black Casters	177.00



---

CBA-60

Add 3" to  
height of  
rack

58"

N/A

11 lbs.

Set of 4-2 1/2" Double wheel locking casters with Spacer Bar and Shock Bracing. For Models DSF-5 and DDF-5 use Model CBA-60. Specify whether a Single (DSF) or Double(DDF) is needed.

Medium Grey Sandstone Black  
with Black Casters

194.00

---



# DS SERIES WALL RACKS

## FINISH COLORS



Black



Lunar White



Medium Grey



Sandstone



Bronze Metallic















## ADDITIONAL NOTES















Ships via UPS.













Hanger style units (DS-H) accept standard 1-1/2" open hangers, CL closed loop hangers or R1.5 receptacles with MG17 PP T-Top or MG17B ball top hangers.









A maximum of 5 hangers per foot are recommended on all DS Series wall racks.



LINE ART	MODEL	H	W	D	WEIGHT	DESCRIPTION	COLOR/FINISH	LIST PRICE
	DS-2H	6 1/2"	24"	11 1/2"	8 lbs.	All powder-coated steel rack with stainless steel 1" hanger bar. Capacity-5 hangers per foot.	<b>Medium Grey</b> , Sandstone, <b>Black</b> , Lunar White or Bronze Metallic	207.00  <b>quick ship</b>
	DS-3H	6 1/2"	36"	11 1/2"	11 lbs.	All powder-coated steel rack with stainless steel 1" hanger bar. Capacity-5 hangers per foot.	<b>Medium Grey</b> , Sandstone, <b>Black</b> , Lunar White or Bronze Metallic	249.00  <b>quick ship</b>
	DS-4H	6 1/2"	48"	11 1/2"	13 lbs.	All powder-coated steel rack with stainless steel 1" hanger bar. Capacity-5 hangers per foot.	<b>Medium Grey</b> , Sandstone, <b>Black</b> , Lunar White or Bronze Metallic	292.00  <b>quick ship</b>
	DS-5H	6 1/2"	60"	11 1/2"	15 lbs.	All powder-coated steel rack with stainless steel 1" hanger bar. Capacity-5 hangers per foot.	<b>Medium Grey</b> , Sandstone, <b>Black</b> , Lunar White or Bronze Metallic	335.00  <b>quick ship</b>
	DS-6H	6 1/2"	72"	11 1/2"	17 lbs.	All powder-coated steel rack with stainless steel 1" hanger bar. Capacity-5 hangers per foot.	<b>Medium Grey</b> , Sandstone, <b>Black</b> , Lunar White or Bronze Metallic	390.00  <b>quick ship</b>
	DS-2HA	6 1/2"	24"	11 1/2"	6 lbs.	Powder-coated steel brackets with clear anodized aluminum shelf tubes and a stainless steel 1" hanger bar. Capacity-5 hangers per foot.	<b>Medium Grey</b> , Sandstone, <b>Black</b> , Lunar White or Bronze Metallic	226.00  <b>quick ship</b>
	DS-3HA	6 1/2"	36"	11 1/2"	9 lbs.	Powder-coated steel brackets with clear anodized aluminum shelf tubes and a stainless steel 1" hanger bar. Capacity-5 hangers per foot.	<b>Medium Grey</b> , Sandstone, <b>Black</b> , Lunar White or Bronze Metallic	262.00  <b>quick ship</b>

	DS-4HA	6 1/2"	48"	11 1/2"	10 lbs.	Powder-coated steel brackets with clear anodized aluminum shelf tubes and a stainless steel 1" hanger bar. Capacity-5 hangers per foot.	<b>Medium Grey, Sandstone, Black,</b> Lunar White or Bronze Metallic	292.00	 <b>quick ship</b>
	DS-5HA	6 1/2"	60"	11 1/2"	13 lbs.	Powder-coated steel brackets with clear anodized aluminum shelf tubes and a stainless steel 1" hanger bar. Capacity-5 hangers per foot.	<b>Medium Grey, Sandstone, Black,</b> Lunar White or Bronze Metallic	385.00	 <b>quick ship</b>
	DS-6HA	6 1/2"	72"	11 1/2"	15 lbs.	Powder-coated steel brackets with clear anodized aluminum shelf tubes and a stainless steel 1" hanger bar. Capacity-5 hangers per foot.	<b>Medium Grey, Sandstone, Black,</b> Lunar White or Bronze Metallic	427.00	 <b>quick ship</b>
	DS-2HO	6 1/2"	24"	11 1/2"	6 lbs.	Powder-coated steel brackets with natural oak shelf tubes and a stainless steel 1" hanger bar. Capacity-5 hangers per foot.	Medium Grey, Sandstone, Black, Lunar White or Bronze Metallic	226.00	
	DS-3HO	6 1/2"	36"	11 1/2"	9 lbs.	Powder-coated steel brackets with natural oak shelf tubes and a stainless steel 1" hanger bar. Capacity-5 hangers per foot.	Medium Grey, Sandstone, Black, Lunar White or Bronze Metallic	317.00	
	DS-4HO	6 1/2"	48"	11 1/2"	10 lbs.	Powder-coated steel brackets with natural oak shelf tubes and a stainless steel 1" hanger bar. Capacity-5 hangers per foot.	Medium Grey, Sandstone, Black, Lunar White or Bronze Metallic	354.00	
	DS-5HO	6 1/2"	60"	11 1/2"	13 lbs.	Powder-coated steel brackets with natural oak shelf tubes and a stainless steel 1" hanger bar. Capacity-5 hangers per foot.	Medium Grey, Sandstone, Black, Lunar White or Bronze Metallic	471.00	
	DS-6HO	6 1/2"	72"	11 1/2"	15 lbs.	Powder-coated steel brackets with natural oak shelf tubes and a stainless steel 1" hanger bar. Capacity-5 hangers per foot.	Medium Grey, Sandstone, Black, Lunar White or Bronze Metallic	502.00	
	DS-2K	6 1/2"	24"	11 1/2"	8 lbs.	All powder-coated steel rack with 4x Charcoal Grey K-73 powder coated triple prong hooks.	Medium Grey, Sandstone, Black, Lunar White or Bronze Metallic	226.00	
	DS-3K	6 1/2"	36"	11 1/2"	10 lbs.	All powder-coated steel rack with 6x Charcoal Grey K-73 powder coated triple prong hooks.	Medium Grey, Sandstone, Black, Lunar White or Bronze Metallic	262.00	
	DS-4K	6 1/2"	48"	11 1/2"	12 lbs.	All powder-coated steel rack with 8x Charcoal Grey K-73 powder coated triple prong hooks.	Medium Grey, Sandstone, Black, Lunar White or Bronze Metallic	311.00	
	DS-5K	6 1/2"	60"	11 1/2"	14 lbs.	All powder-coated steel rack with 12x Charcoal Grey K-73 powder coated triple prong hooks.	Medium Grey, Sandstone, Black, Lunar White or Bronze Metallic	366.00	

	DS-6K	6 1/2"	72"	11 1/2"	16 lbs.	All powder-coated steel rack with 16x Charcoal Grey K-73 powder coated triple prong hooks.	Medium Grey, Sandstone, Black, Lunar White or Bronze Metallic	438.00
	DS-2KA	6 1/2"	24"	11 1/2"	6 lbs.	Powder-coated steel brackets with clear anodized aluminum shelf tubes and 4x Charcoal Grey K-73 powder coated triple prong hooks.	Medium Grey, Sandstone, Black, Lunar White or Bronze Metallic	249.00
	DS-3KA	6 1/2"	36"	11 1/2"	7 lbs.	Powder-coated steel brackets with clear anodized aluminum shelf tubes and 6x Charcoal Grey K-73 powder coated triple prong hooks.	Medium Grey, Sandstone, Black, Lunar White or Bronze Metallic	292.00
	DS-4KA	6 1/2"	48"	11 1/2"	8 lbs.	Powder-coated steel brackets with clear anodized aluminum shelf tubes and 8x Charcoal Grey K-73 powder coated triple prong hooks.	Medium Grey, Sandstone, Black, Lunar White or Bronze Metallic	335.00
	DS-5KA	6 1/2"	60"	11 1/2"	12 lbs.	Powder-coated steel brackets with clear anodized aluminum shelf tubes and 12x Charcoal Grey K-73 powder coated triple prong hooks.	Medium Grey, Sandstone, Black, Lunar White or Bronze Metallic	391.00
	DS-6KA	6 1/2"	72"	11 1/2"	14 lbs.	Powder-coated steel brackets with clear anodized aluminum shelf tubes and 16x Charcoal Grey K-73 powder coated triple prong hooks.	Medium Grey, Sandstone, Black, Lunar White or Bronze Metallic	502.00
	DS-2U	6 1/2"	24"	11 1/2"	6 lbs.	All powder-coated steel rack.	Medium Grey, Sandstone, Black, Lunar White or Bronze Metallic	154.00
	DS-3U	6 1/2"	36"	11 1/2"	8 lbs.	All powder-coated steel rack.	Medium Grey, Sandstone, Black, Lunar White or Bronze Metallic	195.00
	DS-4U	6 1/2"	48"	11 1/2"	10 lbs.	All powder-coated steel rack.	Medium Grey, Sandstone, Black, Lunar White or Bronze Metallic	257.00
	DS-5U	6 1/2"	60"	11 1/2"	12 lbs.	All powder-coated steel rack.	Medium Grey, Sandstone, Black, Lunar White or Bronze Metallic	287.00
	DS-6U	6 1/2"	72"	11 1/2"	15 lbs.	All powder-coated steel rack.	Medium Grey, Sandstone, Black, Lunar White or Bronze Metallic	317.00
	DS-2UA	6 1/2"	24"	11 1/2"	4 lbs.	Powder-coated steel brackets with clear anodized aluminum shelf tubes.	Medium Grey, Sandstone, Black, Lunar White or Bronze Metallic	172.00
	DS-3UA	6 1/2"	36"	11 1/2"	5 lbs.	Powder-coated steel brackets with clear anodized aluminum shelf tubes.	Medium Grey, Sandstone, Black, Lunar White or Bronze Metallic	226.00

	DS-4UA	6 1/2"	48"	11 1/2"	6 lbs.	Powder-coated steel brackets with clear anodized aluminum shelf tubes.	Medium Grey, Sandstone, Black, Lunar White or Bronze Metallic	273.00
	DS-5UA	6 1/2"	60"	11 1/2"	11 lbs.	Powder-coated steel brackets with clear anodized aluminum shelf tubes.	Medium Grey, Sandstone, Black, Lunar White or Bronze Metallic	335.00
	DS-6UA	6 1/2"	72"	11 1/2"	14 lbs.	Powder-coated steel brackets with clear anodized aluminum shelf tubes.	Medium Grey, Sandstone, Black, Lunar White or Bronze Metallic	360.00
	DS-2UO	6 1/2"	24"	11 1/2"	4 lbs.	Powder-coated steel brackets with natural oak shelf tubes.	Medium Grey, Sandstone, Black, Lunar White or Bronze Metallic	195.00
	DS-3UO	6 1/2"	36"	11 1/2"	5 lbs.	Powder-coated steel brackets with natural oak shelf tubes.	Medium Grey, Sandstone, Black, Lunar White or Bronze Metallic	238.00
	DS-4UO	6 1/2"	48"	11 1/2"	6 lbs.	Powder-coated steel brackets with natural oak shelf tubes.	Medium Grey, Sandstone, Black, Lunar White or Bronze Metallic	292.00
	DS-5UO	6 1/2"	60"	11 1/2"	11 lbs.	Powder-coated steel brackets with natural oak shelf tubes.	Medium Grey, Sandstone, Black, Lunar White or Bronze Metallic	366.00
	DS-6UO	6 1/2"	72"	11 1/2"	14 lbs.	Powder-coated steel brackets with natural oak shelf tubes.	Medium Grey, Sandstone, Black, Lunar White or Bronze Metallic	438.00

# FRAME

## FINISH COLORS



Textured Black



Textured White

## PANEL FINISH COLORS

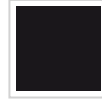

Black



Dark Green



Mirror

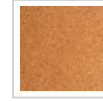

Pinboard

## ADDITIONAL NOTES

Ships via common carrier.

FRAME models with melamine, mirror or pinboard panel must be anchored to the wall for stability. Hardware provided.



Pair FRAME with TUBULUS, UNIVERSUM or any standard 1 1/2" open hook hangers.

Assembly required.

Sample chips available.



LINE ART	MODEL	H	W	D	WEIGHT	DESCRIPTION	COLOR/FINISH	LIST PRICE
	FRAME-DV47	66 15/16"	17 3/4"	18 1/2"	23 lbs.	Painted steel coat rack.	Textured Black or Textured White	1,395.00
	FRAME-DV47-P	66 15/16"	17 3/4"	18 1/2"	40 lbs.	Painted steel coat rack with melamine panel. Wall mount required for stability.	Textured Black or Textured White with Black or Dark Green melamine panel	2,095.00
	FRAME-DV47-S	66 15/16"	17 3/4"	18 1/2"	52 lbs.	Painted steel coat rack with mirror. Wall mount required for stability.	Textured Black or Textured White	2,565.00
	FRAME-DV47-B	66 15/16"	17 3/4"	18 1/2"	46 lbs.	Painted steel coat rack with pinboard panel. Wall mount required for stability.	Textured Black or Textured White with cork colored pinboard panel	3,125.00
	FRAME-DV89	66 15/16"	17 3/4"	35 1/16"	25 lbs.	Painted steel coat rack.	Textured Black or Textured White	1,540.00
	FRAME-DV89-P	66 15/16"	17 3/4"	35 1/16"	43 lbs.	Painted steel coat rack with melamine panel. Wall mount required for stability.	Textured Black or Textured White with Black or Dark Green melamine panel	2,235.00

	FRAME-DV89-S	66 15/16"	17 3/4"	35 1/16"	54 lbs.	Painted steel coat rack with mirror. Wall mount required for stability.	Textured Black or Textured White	2,620.00
	FRAME-DV89-B	66 15/16"	17 3/4"	35 1/16"	49 lbs.	Painted steel coat rack with pinboard panel. Wall mount required for stability.	Textured Black or Textured White with cork colored pinboard panel	3,250.00

## MEGA RAK

### FINISH COLORS



Charcoal Grey





### ADDITIONAL NOTES

Ships via common carrier.

Junior height (48" High) available for all Mega Rak models. Specify "Junior Height" on purchase order. Additional charge of \$79.00 net per unit applies.

Sample chips available.



LINE ART	MODEL	H	W	D	WEIGHT	DESCRIPTION	COLOR/FINISH	LIST PRICE
	MR-801H	81" Closed 60" Open	25"	18" Closed 97" Open	99 lbs.	Hanger style folding rack with wire grid shelves on 4" ball bearing locking casters. Holds up to 100 coats. Use with MG-17PM, any 1-1/2" open hook or mini hook hangers.	Charcoal Grey Frame with Medium Grey Shelf	2,055.00
	MR-801K	81" Closed 60" Open	25"	18" Closed 97" Open	125 lbs.	Hook style folding rack with wire grid shelves on 4" ball bearing locking casters. Comes complete with 48K-73 triple prong hooks, capacity 144 coats	Charcoal Grey Frame with Medium Grey Shelf	2,295.00
	MR-611H	81" Closed 60" Open	25"	18" Closed 72" Open	107 lbs.	Hanger style folding rack with 1" stainless steel hanger bars on 4" ball bearing locking casters. Holds up to 72 coats. Use with MG-17PH or any standard 1-1/2" open hook hanger.	Black	1,975.00
	MR-611K	81" Closed 60" Open	25"	18" Closed 72" Open	120 lbs.	Hook style folding rack, on 4" ball bearing locking casters. Comes complete with 40K-73 triple prong hooks, capacity 120 coats.	Black	2,055.00
	MR-UMB	10"	10"	3"	5 lbs.	Set of 2 umbrella holders which attach to the frame capacity 6 umbrellas	Charcoal Grey	90.00
	MR-HC	N/A				Set of 4 hooks to store hangers on Mega Rak. Must be used with MG17OHN hangers only. Must be ordered at same time as Mega Rak unit.	Chrome	68.00

# OFFICE RAK

## FINISH COLORS



Black



Medium Grey



Sandstone

## ADDITIONAL NOTES

Ships via UPS

Office Rak can be adapted for use with CST4 casters.

Office Rak is standard with MG17PM Charcoal Grey hangers.

Sample chips available.



LINE ART	MODEL	H	W	D	WEIGHT	DESCRIPTION	COLOR/FINISH	LIST PRICE
	OR-2A	60"	24"	18"	40 lbs	Single sided coat rack with hanger spacers, two lower umbrella holders and a top and bottom shelf. Includes 8x Charcoal Grey MG17PM hangers.	<b>Black, Medium Grey, Sandstone</b>	760.00  <b>quick ship</b>
	OR-3A	60"	36"	18"	45 lbs	Single sided coat rack with hanger spacers, two lower umbrella holders and a top and bottom shelf. Includes 12x Charcoal Grey MG17PM hangers.	<b>Black, Medium Grey, Sandstone</b>	835.00  <b>quick ship</b>
	OR-4A	60"	48"	18"	51 lbs	Single sided coat rack with hanger spacers, two lower umbrella holders and a top and bottom shelf. Includes 16x Charcoal Grey MG17PM hangers.	<b>Black, Medium Grey, Sandstone</b>	875.00  <b>quick ship</b>
	OR-2B	60"	24"	18"	33 lbs	Single sided coat rack with a top shelf. Includes 8x Charcoal Grey MG17PM hangers.	<b>Black, Medium Grey, Sandstone</b>	575.00  <b>quick ship</b>
	OR-3B	60"	36"	18"	35 lbs	Single sided coat rack with a top shelf. Includes 12x Charcoal Grey MG17PM hangers.	<b>Black, Medium Grey, Sandstone</b>	615.00  <b>quick ship</b>
	OR-4B	60"	48"	18"	40 lbs	Single sided coat rack with a top shelf. Includes 16x Charcoal Grey MG17PM hangers.	<b>Black, Medium Grey, Sandstone</b>	685.00  <b>quick ship</b>
	CST-4	2 1/2"			3 lbs	Set of 4 Double wheel locking furniture casters. Add 2 1/2" to height of rack. For use with OR, RR and Designer Series* style racks.	<b>Black</b>	65.00  <b>quick ship</b>

# RAP RAK

## FINISH COLORS

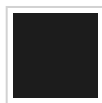

Black



Medium Grey



Sandstone

## ADDITIONAL NOTES









Ships via UPS

Hanger capacity 40-48 coats or use with KSF-4

Rap Rak units accept theft deterrent MG17PM hangers or any standard 1-1/2" open hook or 5/8" mini hook hangers.

Sample chips available.



LINE ART	MODEL	H	W	D	WEIGHT	DESCRIPTION	COLOR/FINISH	LIST PRICE
	RR-4F	60"	48"	23"	39 lbs	Double Sided Floor Rack	<b>Black, Medium Grey</b> or Sandstone	730.00  <b>quick ship</b>
	RR4F-HD	60"	48"	23"	39 lbs	Heavy Duty Double Sided Floor Rack with upper and lower spacer bars	Black	770.00
	RR-4J	48"	48"	23"	39 lbs	Double Sided Floor Rack-Junior Height	Black, Medium Grey or Sandstone	730.00
	KSF-4	3 1/4"	46"	2 1/2"	9 lbs	Two 4 ft. Hook Rails with 10 K-73 Triple Prong Hooks-30 capacity for use with RR-4F or RR-4J only	Medium Grey, Black or Sandstone Rail w/Charcoal Grey Hooks	185.00
	CST-4	2 1/2"			3 lbs	Set of 4 Double wheel locking furniture casters. Add 2 1/2" to height of rack. For use with OR, RR and Designer Series* style racks	<b>Black</b>	65.00  <b>quick ship</b>
	CST-4RE	4"			5 lbs	Set of 4 Heavy Duty 4" locking casters. Add 4" to height of rack. For use with RR and DDF style racks only. (Caster base assembly still required for DDF)	Black	150.00





# TERTIO

## ADDITIONAL NOTES

Ships via common carrier.







LINE ART	MODEL	H	W	D	WEIGHT	DESCRIPTION	COLOR/FINISH	LIST PRICE
	T-EV/K-100	66 15/16"	39 3/8"	23 5/8"	39 lbs.	Single Sided Floor Rack-Powder-coated frames with satin anodized aluminum shelf, includes 10 hangers	Dark Grey with Satin Aluminum	2,380.00
	T-DV/K-100	66 15/16"	39 3/8"	40 3/16"	47 lbs.	Double Sided Floor Rack-Powder-coated frames with satin anodized aluminum shelf, includes 20 hangers	Dark Grey with Satin Aluminum	3,295.00
	T-UMB-100	19 11/16"	39 3/8"	5 9/16"	15 lbs.	Umbrella Stand which integrates into the EV model complete with drip tray and rubber mat.	Satin Anodized Aluminum	855.00

# TERTIO W/K

## ADDITIONAL NOTES

Ships via UPS





LINE ART	MODEL	H	W	D	WEIGHT	DESCRIPTION	COLOR/FINISH	LIST PRICE
	T-W/K-60	11 13/16"	23 5/8"	21 1/4"	7 lbs.	Wall rack with powder coated brackets and satin anodized aluminum shelf. Includes 6 hangers	Dark Grey with Satin Aluminum	798.00
	T-W/K-100	11 13/16"	39 3/8"	21 1/4"	12 lbs.	Wall rack with powder coated brackets and satin anodized aluminum shelf. Includes 10 hangers	Dark Grey with Satin Aluminum	1,125.00
	T-W/K-120	11 13/16"	47 1/4"	21 1/4"	14 lbs.	Wall rack with powder coated brackets and satin anodized aluminum shelf. Includes 12 hangers	Dark Grey with Satin Aluminum	1,305.00
	T-W/K-150	11 13/16"	59 1/16"	21 1/4"	17 lbs.	Wall rack with powder coated brackets and satin anodized aluminum shelf. Includes 14 hangers	Dark Grey with Satin Aluminum	1,695.00
	T-W/K-180	11 13/16"	70 7/8"	21 1/4"	21 lbs.	Wall rack with powder coated brackets and satin anodized aluminum shelf. Includes 18 hangers	Dark Grey with Satin Aluminum	1,945.00

# TERTIO W2

## ADDITIONAL NOTES

Ships via UPS



LINE ART	MODEL	H	W	D	WEIGHT	DESCRIPTION	COLOR/FINISH	LIST PRICE
	T-W2-60	6 5/16"	23 5/8"	13"	7 lbs.	Hook style wall rack with powder coated brackets and satin anodized aluminum shelf. Includes 11 dark grey plastic hooks.	Dark Grey with Satin Aluminum	625.00
	T-W2-90	6 5/16"	35 7/16"	13"	10 lbs.	Hook style wall rack with powder coated brackets and satin anodized aluminum shelf. Includes 17 dark grey plastic hooks.	Dark Grey with Satin Aluminum	835.00
	T-W2-120	6 5/16"	47 1/4"	13"	14 lbs.	Hook style wall rack with powder coated brackets and satin anodized aluminum shelf. Includes 23 dark grey plastic hooks.	Dark Grey with Satin Aluminum	1,015.00

# COAT HANGERS

HOME → PRODUCTS → COAT HANGERS

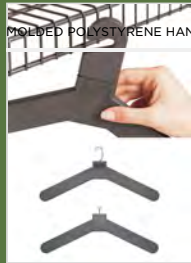
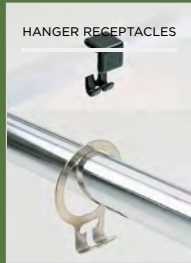
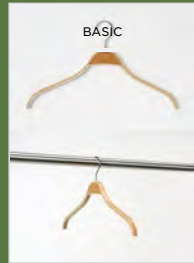



# BASIC

## ADDITIONAL NOTES

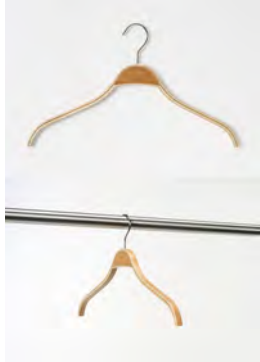
Ships via UPS





LINE ART	MODEL	H	W	D	WEIGHT	DESCRIPTION	COLOR/FINISH	LIST PRICE
	BASIC	9 3/4"	17 5/8"	11/16"	3 lbs.	Laminated Beech Veneer coat hanger with chrome hook. Quantity of 1.	Laminated Beech	23.00
	BASIC-10	9 3/4"	17 5/8"	11/16"	3 lbs.	Laminated Beech Veneer coat hanger with chrome hook. Quantity of 10.	Laminated Beech	225.00

# FILO

## ADDITIONAL NOTES

Ships via UPS





LINE ART	MODEL	H	W	D	WEIGHT	DESCRIPTION	COLOR/FINISH	LIST PRICE
	FILO-A	9 7/16"	17 5/16"	2 3/8"	1 lbs.	Epoxy coated wire theft deterrent closed loop hanger	White, Black, Silver or Sand	46.00
	FILO-S	9 7/16"	17 5/16"	2 3/8"	1 lbs.	Epoxy coated wire open hook hanger	White, Black, Silver or Sand	46.00

# GRIP

## ADDITIONAL NOTES

Ships via UPS





LINE ART	MODEL	H	W	D	WEIGHT	DESCRIPTION	COLOR/FINISH	LIST PRICE
	GRIP	9 3/4"	17 5/8"	11/16"	3 lbs.	Beech coat hanger with black rubber coating, hook in black galvanized steel. Quantity of 1.	Black	29.00
	GRIP-10	9 3/4"	17 5/8"	11/16"	3 lbs.	Beech coat hanger with black rubber coating, hook in black galvanized steel. Quantity of 10.	Black	285.00

# HANGER RECEPTACLES

## ADDITIONAL NOTES

Ships via UPS



LINE ART	MODEL	H	W	D	WEIGHT	DESCRIPTION	COLOR/FINISH	LIST PRICE
	R1.5	2 1/2"	1 15/16"	1/2"	1/4 lb.	Receptacle for 1 1/4" O.D. hanger rod	Plated steel	11.00
	SR.34	2 3/16"	7/8"	7/8"	1/4 lb.	Receptacle for 3/4" square tube	Black or Charcoal Grey	13.00

## ADDITIONAL NOTES

Ships via UPS















LINE ART	MODEL	H	W	D	WEIGHT	DESCRIPTION	COLOR/FINISH	LIST PRICE
	MIRAC-6	3"	19 11/16"	1"	4 lbs.	Plastic coat hanger, carton of 6 each.	Transparent plastic	260.00

# MOLDED POLYSTYRENE HANGERS









## ADDITIONAL NOTES

Ships via UPS



LINE ART	MODEL	H	W	D	WEIGHT	DESCRIPTION	COLOR/FINISH	LIST PRICE
	MG-17PM	8 7/8"	17"	3/4"	1/4 lb.	Slotted plastic anti-theft design 1 ea	<b>Black, Charcoal Grey</b>	20.00
								 <b>quick ship</b>
	MG-17PM-6	8 7/8"	17"	3/4"	3 lbs.	Slotted plastic anti-theft design 6 pk	Black, Charcoal Grey	74.00
	MG-17PM-24	8 7/8"	17"	3/4"	8 lbs.	Slotted plastic anti-theft design 24 pk	Black, Charcoal Grey	205.00
	MG-17PM-100	8 7/8"	17"	3/4"	30 lbs.	Slotted plastic anti-theft design 100 pk	Black, Charcoal Grey	769.00
	MG-17PH	9"	17"	3/4"	1/4 lb.	Open hook polystyrene 1 pk	<b>Black, Charcoal Grey</b>	20.00
								 <b>quick ship</b>
	MG-17PH-6	9"	17"	3/4"	3 lbs.	Open hook polystyrene 6 pk	Black, Charcoal Grey	74.00
	MG-17PH-24	9"	17"	3/4"	8 lbs.	Open hook polystyrene 24 pk	Black, Charcoal Grey	205.00
	MG-17PH-100	9"	17"	3/4"	30 lbs.	Open hook polystyrene 100 pk	Black, Charcoal Grey	769.00
	MG-17PS	7 7/8"	17"	3/4"	1/4 lb.	Mini hook polystyrene 1 ea	Black, Charcoal Grey	20.00
	MG-17PS-6	7 7/8"	17"	3/4"	3 lbs.	Mini hook polystyrene 6 pk	Black, Charcoal Grey	74.00









	MG-17PS-24	7 7/8"	17"	3/4"	8 lbs.	Mini hook polystyrene 24 pk	Black, Charcoal Grey	205.00
	MG-17PS-100	7 7/8"	17"	3/4"	30 lbs.	Mini hook polystyrene 100 pk	Black, Charcoal Grey	769.00
	MG-17PX	6 7/8"	17"	3/4"	1/4 lb.	T-top polystyrene hanger for use with SR34 Hanger Receptacle. Quantity of 1.	Black, Charcoal Grey	20.00
	MG-17PX-24	6 7/8"	17"	3/4"	8 lbs.	T-top polystyrene hanger for use with SR34 Hanger Receptacle. Quantity of 24.	Black, Charcoal Grey	205.00
	MG-17PX-100	6 7/8"	17"	3/4"	30 lbs.	T-top polystyrene hanger for use with SR34 Hanger Receptacle. Quantity of 100.	Black, Charcoal Grey	769.00
	MG-17PP	6 7/8"	17"	3/4"	1/4 lb.	T-top polystyrene hanger for use with R1.5 Hanger Receptacle. Quantity of 1.	Black, Charcoal Grey	20.00
	MG-17PP-24	6 7/8"	17"	3/4"	8 lbs.	T-top polystyrene hanger for use with R1.5 Hanger Receptacle. Quantity of 24.	Black, Charcoal Grey	205.00
	MG-17PP-100	6 7/8"	17"	3/4"	30 lbs.	T-top polystyrene hanger for use with R1.5 Hanger Receptacle. Quantity of 100.	Black, Charcoal Grey	769.00

# STEEL HANGERS

## ADDITIONAL NOTES

Ships via UPS





LINE ART	MODEL	H	W	D	WEIGHT	DESCRIPTION	COLOR/FINISH	LIST PRICE
	MG-17OHN	7 5/8"	17"	1/8"	1/4 lb.	Wire open hook 1 ea	Silver	15.00
								 <b>quick ship</b>
	MG-17OHN-50	7 5/8"	17"	1/8"	18 lbs.	Wire open hook 50 pk	Silver	385.00
	MG-17CL	7 5/8"	17"	1/8"	1/4 lb.	Wire closed loop hanger 1 ea	Silver	15.00
								 <b>quick ship</b>
	MG-17CL-50	7 5/8"	17"	1/8"	18 lbs.	Wire closed loop hanger 50 pk	Silver	385.00

# TUBULUS

## ADDITIONAL NOTES

Ships via UPS



LINE ART	MODEL	H	W	D	WEIGHT	DESCRIPTION	COLOR/FINISH	LIST PRICE
	TUB-100	7 7/8"	17 1/4"	7/8"	.5 lbs.	Plastic coat hanger with stainless steel open hook.	Black 9311, White 9310, Light Blue 5324, Red 3309, Dark Grey, Yellow 1304	47.00
	TUB-200	7 7/8"	17 1/4"	7/8"	.5 lbs.	Plastic coat hanger with theft-deterrent stainless steel closed loop.	Dark Grey or White	52.00

## ADDITIONAL NOTES

Ships via UPS



LINE ART	MODEL	H	W	D	WEIGHT	DESCRIPTION	COLOR/FINISH	LIST PRICE
	UNI-20	8 1/4"	17 7/8"	3/4"	.5 lbs	Plastic coat hanger with aluminum trouser bar and open hook	Black with silver aluminum trouser bar.	47.00

