



Alpha

Flexible Laboratory Systems



Alpha

Flexible Laboratory Systems





Innovative Designs

Ultimate Flexibility for Laboratories



Kewaunee's Alpha family of products is designed to meet the needs of the modern laboratory where flexibility and adjustability are essential. Alpha uses fixed modules and carts to support worksurfaces, casework, shelving, carts, and accessories. Components allow for customization of each workstation. The Alpha system integrates with horizontal and vertical services including plumbing, power, and data. The Alpha family offers a complete offering of interchangeable components.



Modular Workstations

- Self-supporting tables
- Double-sided or single sided
- Adjustable height workstations
- Integrated shelving systems
- Pre-plumbed services



Mobile Carts

- Convenient and mobile
- Available in standard lengths
- Large diameter, heavy duty casters or glides available
- Accepts many standard components



Service Carriers

- Ceiling Panels
- Overhead Service Enclosures
- Overhead Service Manifolds

Work Top and Ledge Materials

Specifications:

Worksurface Top and Ledge material selections are among the most critical of the laboratory furniture decisions. The intended applications of your work tops dictate material choice. Surfaces could be exposed to reagents and caustic substances. Heavy equipment may need to be supported or only light duty tasks may be performed.

Kewaunee offers three basic work top materials for use on the Alpha System. They are Kewaunee's exclusive Kemresin®, Phenolic Resin and High Pressure Plastic Laminates. All are available in standard sizes to match the Alpha System modules and are complimented with appropriate sinks, drains and accessories.

Work Top and Ledge Material Comparison

MATERIAL	APPEARANCE	COMPOSITION	CHEMICAL RESISTANCE	APPLICATIONS
KEMRESIN®	Black, Grey, Putty, or Slate, ultra-smooth, non-porous	1" thick molded epoxy resin	Excellent resistance to practically all acids, alkalies and solvents	Use wherever optimum physical and chemical resisting properties are required
PHENOLIC RESIN	Hard, smooth surface, various colors	Cellulose fiber reinforced phenolic resin core with a highly crosslinked polyurethane copolymer surface	Excellent resistance to practically all acids, alkalies and solvents	Chemical and biological labs
HIGH PRESSURE LAMINATES	Hard, smooth surface, various colors	Plastic laminate surface attached with water resistant adhesive to solid particle board	Fair chemical resistance to wide range of acids, alkalies and solvents (Strong reagent solutions do attack, and material is almost impossible to repair satisfactorily)	Recommended for light duty purposes in science and technical laboratories or educational institutions, and for pharmacies and nurses stations in hospitals

Work Top Styles — Front Edge

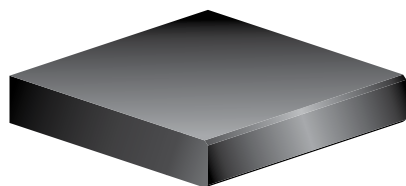

Kewaunee KEMRESIN®
1/8" Chamfer



Phenolic Resin
1/8" Chamfer

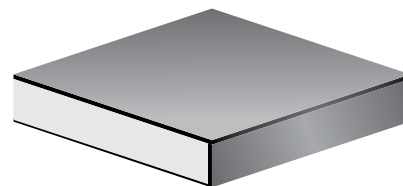

HIGH PRESSURE LAMINATES
Square – Self-Edged

Color Selection:

Kewaunee KEMRESIN®

Black
Grey
Putty
Slate

PHENOLIC RESIN

Phenolic Resin is furnished Black as standard. Other colors and patterns are available on special order. Contact your Kewaunee representative for current offerings.

HIGH PRESSURE LAMINATES

High-Pressure Laminate is furnished Black as standard. Other colors and patterns are available on special order. Contact your Kewaunee representative for current offerings.

Custom Work Tops

Specifications:
 Continuous worksurface tops are available in two basic styles for applications that require an uninterrupted surface. All three top materials, Kemresin, Phenolic Resin, and High Pressure Laminate, may be fabricated into both flat tops, or flat tops with 1" thick applied curbs at the rear.
 Fitting and fixture holes and cutouts can be incorporated in these styles to allow unlimited design options.
 See charts below for material size and color options.

1" Thick Flat Worksurface Top

Standard Depths 24" 30"

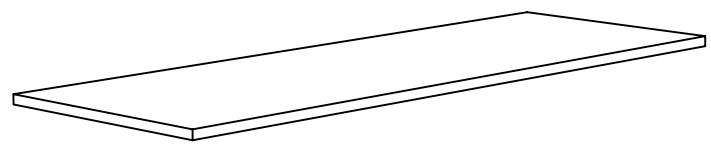

Available Materials	Maximum Length without Joint
Kewaunee Kemresin®	96"
Phenolic Resin	120"
High Pressure Laminate	120"

1" Thick Worksurface Top with 1" x 4" Applied Curb

Standard Depths 24" 30"

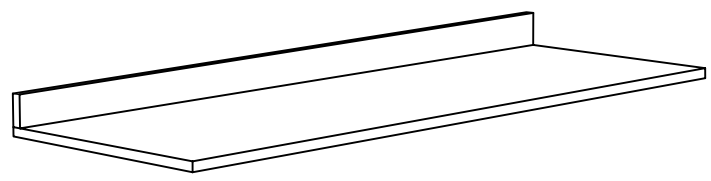

Available Materials	Maximum Length without Joint
Kewaunee Kemresin®	96"
Phenolic Resin	120"
High Pressure Laminate	120"

Color Selection:

Kewaunee KEMRESIN®
 Black
 Grey
 Putty
 Slate

PHENOLIC RESIN
 Phenolic Resin is furnished Black as standard. Other colors and patterns are available on special order. Contact your Kewaunee representative for current offerings.

HIGH PRESSURE LAMINATES
 High-Pressure Laminate is furnished Black as standard. Other colors and patterns are available on special order. Contact your Kewaunee representative for current offerings.

Alpha System Carts

Features:

- The adaptability of the Alpha System and the convenience of mobility
 - Standard double-slotted uprights mounted on heavy gauge steel frame
 - Available with large diameter, heavy duty casters or glides
 - Available with or without overhead carrier
 - Available in all standard module lengths – from 24" to 72"
- Accepts standard Alpha System components including:
- Adjustable Height Cantilevered Worksurface Frames
 - for supporting Worksurface Top and Suspended Base Cabinets
 - easily positioned on 1" increments
 - Adjustable Module Shelving
 - available in five depths
 - available in steel, wood, and phenolic resin
 - available with or without retaining lips
 - adjustable on 1" increments

SEFA 10 | Class 8 – Configuration 1 – Category 1

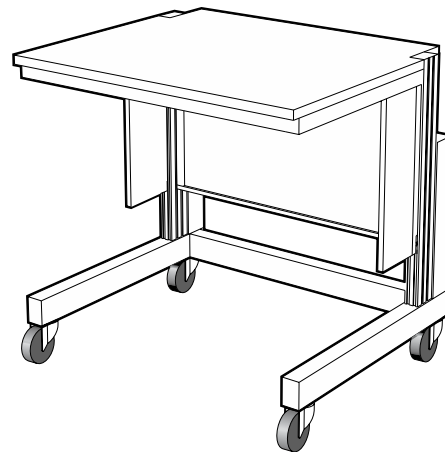
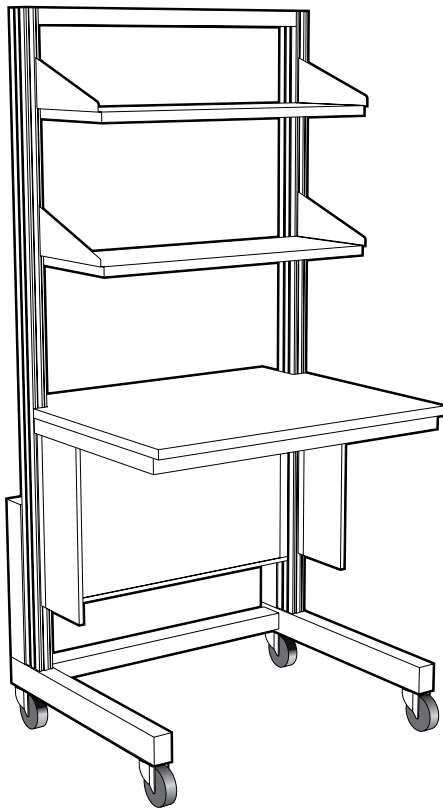

Select Alpha System Cart frame components and Worksurface Tops from the following two pages. Select Adjustable Module Shelves from pages 51-56

Cantilevered Worksurface Frames from pages 58 and 59, suspended base cabinets from pages 100 through 108 and suspended upper cabinets from pages 136 through 141.

Alpha System Carts

Specifications:

Alpha System Carts incorporate the same double slotted uprights used in the Alpha System Structural Modules. The uprights are mounted to a base fabricated of steel tubing and mounted on 4" diameter casters or glides. This creates a mobile system designed to support both the same Cantilevered Worksurface Frames and Adjustable Shelves used on the Structural Support Modules.

The Alpha System Cart is 37" high, with Upper Carrier 78" high. Both are 30" deep and available in lengths shown.

Worksurface Frame, Top and Adjustable Shelves must be ordered separately.

Alpha System Cart

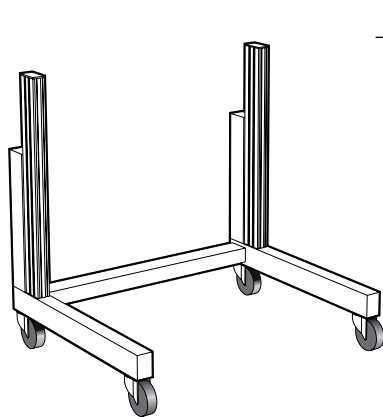

Length	with Caster	with Glides
24"	F57-3724-0C	F57-3724-0G
30"	F57-3730-0C	F57-3730-0G
36"	F57-3736-0C	F57-3736-0G
42"	F57-3742-0C	F57-3742-0G
48"	F57-3748-0C	F57-3748-0G
54"	F57-3754-0C	F57-3754-0G
60"	F57-3760-0C	F57-3760-0G
66"	F57-3766-0C	F57-3766-0G
72"	F57-3772-0C	F57-3772-0G

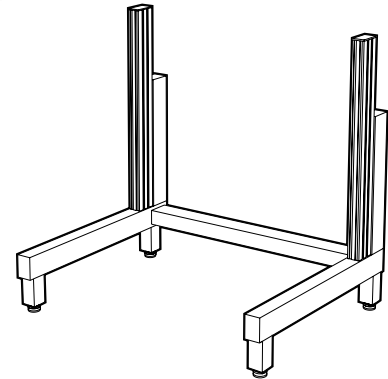

Alpha System Cart with Upper Carrier

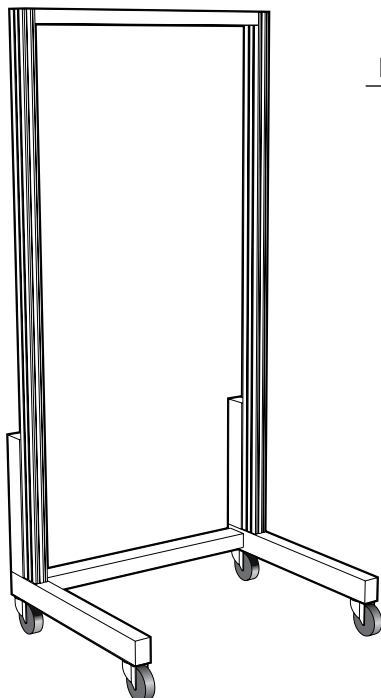

Length	with Casters	with Glides
24"	F57-7824-0C	F57-7824-0G
30"	F57-7830-0C	F57-7830-0G
36"	F57-7836-0C	F57-7836-0G
42"	F57-7842-0C	F57-7842-0G
48"	F57-7848-0C	F57-7848-0G
54"	F57-7854-0C	F57-7854-0G
60"	F57-7860-0C	F57-7860-0G
66"	F57-7866-0C	F57-7866-0G
72"	F57-7872-0C	F57-7872-0G

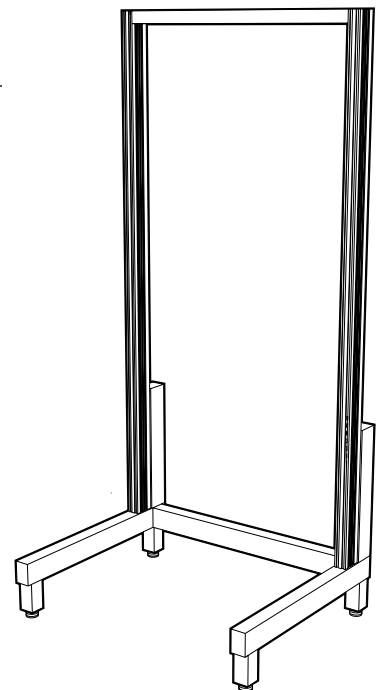

Alpha System Carts

Specifications:

Alpha System Cart Worksurface Tops are available in modular sizes to match the length and depth of the Worksurface Frames. Worksurface Tops are 1" thick. Front edges are treated as shown on page 69. All other edges are finished square.

Electrical Service Strip & Modesty Panel for Alpha System Cart

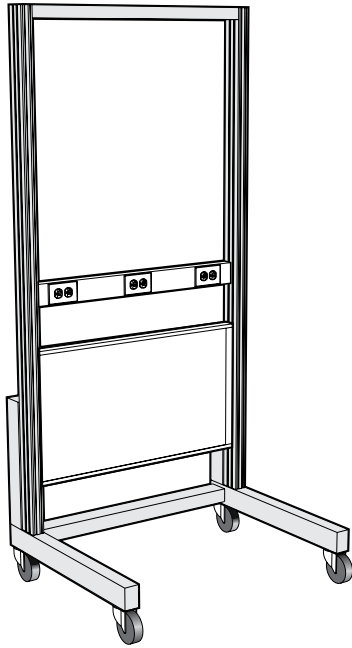

Length	Electrical Service Strip	Duplex Outlets
24"	F56M0324-00	2
30"	F56M0330-00	2
36"	F56M0336-00	3
42"	F56M0342-00	3
48"	F56M0348-00	3
54"	F56M0354-00	3
60"	F56M0360-00	3
66"	F56M0366-00	3
72"	F56M0372-00	3

Length	Modesty Panel
24"	F57M1924-00
30"	F57M1930-00
36"	F57M1936-00
42"	F57M1942-00
48"	F57M1948-00
54"	F57M1954-00
60"	F57M1960-00
66"	F57M1966-00
72"	F57M1972-00

Alpha System Cart Worksurface

see page 58-59 for Worksurface Frames

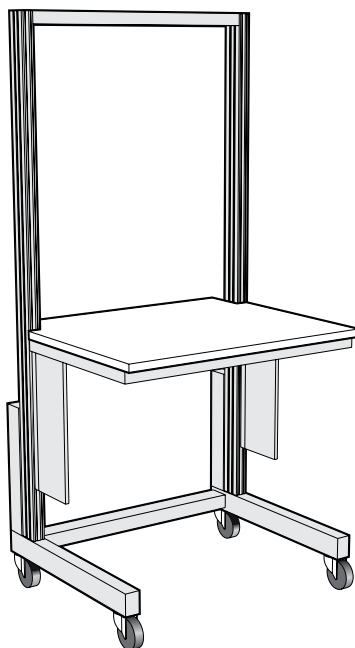

Length	Kemresin®	Phenolic Resin	High Pressure Laminate	
24" TOP for 23" deep frames	24"	F58R3024-00	F58T3024-00	F58P3024-00
	30"	F58R3030-00	F58T3030-00	F58P3030-00
	36"	F58R3036-00	F58T3036-00	F58P3036-00
	42"	F58R3042-00	F58T3042-00	F58P3042-00
	48"	F58R3048-00	F58T3048-00	F58P3048-00
	54"	F58R3054-00	F58T3054-00	F58P3054-00
	60"	F58R3060-00	F58T3060-00	F58P3060-00
	66"	F58R3066-00	F58T3066-00	F58P3066-00
	72"	F58R3072-00	F58T3072-00	F58P3072-00

Length	Kemresin®	Phenolic Resin	High Pressure Laminate	
30" TOP for 29" deep frames	24"	F58R3624-00	F58T3624-00	F58P3624-00
	30"	F58R3630-00	F58T3630-00	F58P3630-00
	36"	F58R3636-00	F58T3636-00	F58P3636-00
	42"	F58R3642-00	F58T3642-00	F58P3642-00
	48"	F58R3648-00	F58T3648-00	F58P3648-00
	54"	F58R3654-00	F58T3654-00	F58P3654-00
	60"	F58R3660-00	F58T3660-00	F58P3660-00
	66"	F58R3666-00	F58T3666-00	F58P3666-00
	72"	F58R3672-00	F58T3672-00	F58P3672-00

see page 58-59 for Worksurface Frames

Heavy Duty Alpha System Cart

Heavy Duty Alpha System Cart Assembly

SEFA 10 | Class 8 – Configuration 1 – Category 4

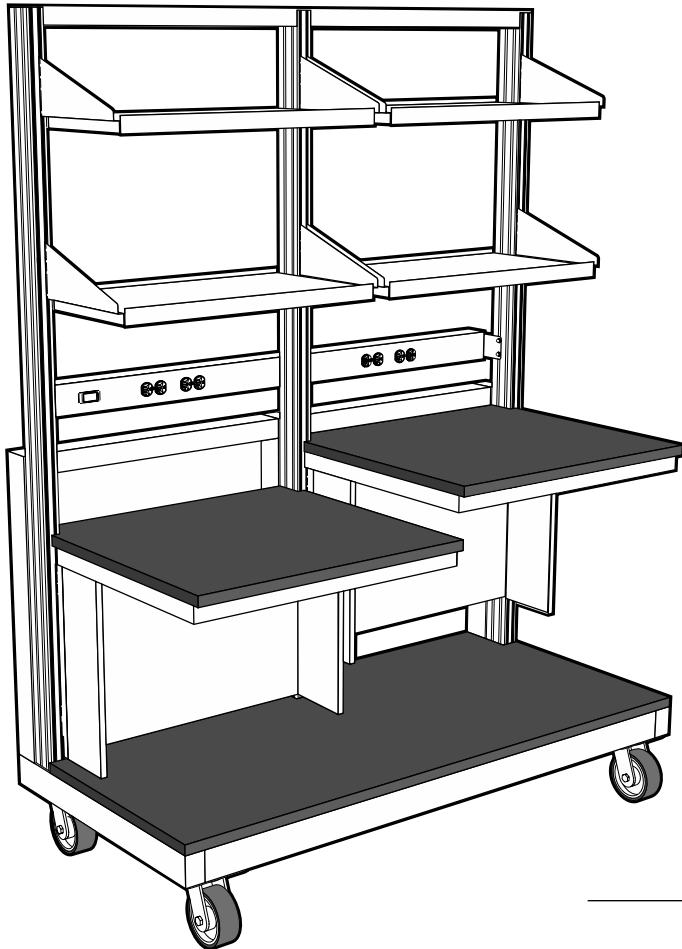

Features:

- 3000 pound load capacity
- Two adjustable height, half-length, Kemresin Worktops with locking frames
- Worktops individually adjustable on 1" centers from 33" to 40"
- Four 15" deep, half-length, adjustable height, steel locking shelves with retaining lips on front and rear
- Shelves adjustable on 1" centers
- One 24" deep fixed, Kemresin shelf at base of bench
- One switched, adjustable height, power strip with four duplex receptacles and 10 foot pigtail
- Four heavy duty casters, with locking brakes on front casters
- Overall dimensions: 30" deep x 79½" high

Heavy Duty Alpha System Cart Assembly

Length

48"	F98-2448-00
60"	F98-2460-00
72"	F98-2472-00

Worksurface Color Option Code

Kemresin

BK = Black **GR** = Grey **PT**=Putty **SL** = Slate

Kemresin is available in four standard colors. To specify Kemresin color, place a dash and the two-letter code at the end of the part number.

Example: F98-2448-00-**BK** for Black

If no color is specified, Kemresin will be furnished in Black.

Elevation Tables

Features:

- Adjustable in height from 31" to 37"
- Available in three different adjustment mechanisms:
 - Manual Hydraulic, which uses a fold-away crank to raise and lower the table.
 - Motorized Hydraulic, which uses a rocker switch to control a motor that raises and lowers the table.
 - Telescoping Legs, which are adjustable on 1" increments using a self-locating locking pin.
- Light weight sturdy construction using tubular cold rolled steel and extruded aluminum.
- Designed to support loads up to 400 pounds.
- Available in either left-hand or right-hand construction.
- Available in unique shapes for specialized and diverse projects and tasks.

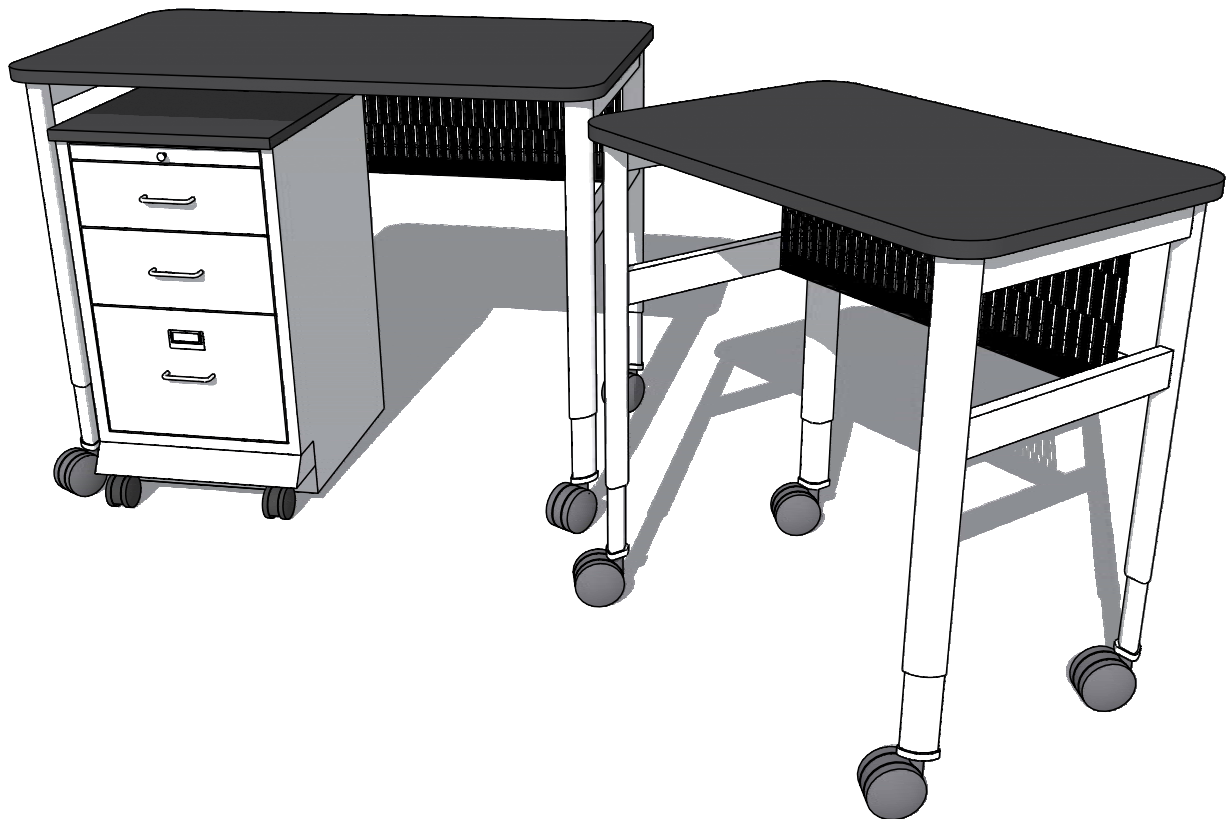

Elevation Tables

Specifications:

The Alpha System Elevation Table is fabricated with a black painted steel frame and telescoping aluminum legs designed to carry a load of 400 pounds. Height is adjustable from 31" to 37". The table is available in a choice of three height adjustment methods. The height of the Manual Hydraulic Table is controlled by a folding crank located at the rear of the end frame. The height of the Motorized Hydraulic Table is controlled by a rocker

switch located at the front of the end frame. The table is also available with telescoping legs that are adjustable on 1" centers using a locking pin. All tables are furnished with stretchers and a 10" high modesty panel and are available with either glides or locking casters.

Elevation Table Work Tops must be ordered separately.

Elevation Table with Manual Hydraulic Height Control

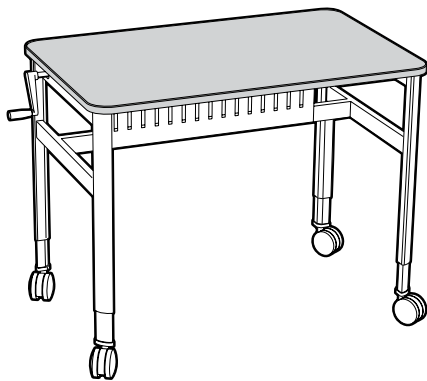

Length	Right Hand 24" Deep Table		Right Hand 30" Deep Table	
	with Glides	with Casters	with Glides	with Casters
36"	F52M2436R21	F52M2436R22	F52M3036R21	F52M3036R22
42"	F52M2442R21	F52M2442R22	F52M3042R21	F52M3042R22
48"	F52M2448R21	F52M2448R22	F52M3048R21	F52M3048R22
54"	F52M2454R21	F52M2454R22	F52M3054R21	F52M3054R22
60"	F52M2460R21	F52M2460R22	F52M3060R21	F52M3060R22
66"	F52M2466R21	F52M2466R22	F52M3066R21	F52M3066R22
72"	F52M2472R21	F52M2472R22	F52M3072R21	F52M3072R22

Length	Left Hand 24" Deep Table		Left Hand 30" Deep Table	
	with Glides	with Casters	with Glides	with Casters
36"	F52M2436L21	F52M2436L22	F52M3036L21	F52M3036L22
42"	F52M2442L21	F52M2442L22	F52M3042L21	F52M3042L22
48"	F52M2448L21	F52M2448L22	F52M3048L21	F52M3048L22
54"	F52M2454L21	F52M2454L22	F52M3054L21	F52M3054L22
60"	F52M2460L21	F52M2460L22	F52M3060L21	F52M3060L22
66"	F52M2466L21	F52M2466L22	F52M3066L21	F52M3066L22
72"	F52M2472L21	F52M2472L22	F52M3072L21	F52M3072L22

Elevation Table with Motorized Hydraulic Height Control

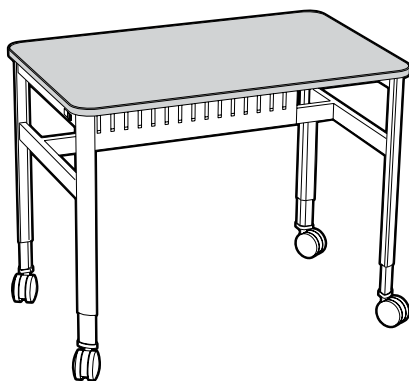

Length	Right Hand 24" Deep Table		Right Hand 30" Deep Table	
	with Glides	with Casters	with Glides	with Casters
36"	F52M2436R31	F52M2436R32	F52M3036R31	F52M3036R32
42"	F52M2442R31	F52M2442R32	F52M3042R31	F52M3042R32
48"	F52M2448R31	F52M2448R32	F52M3048R31	F52M3048R32
54"	F52M2454R31	F52M2454R32	F52M3054R31	F52M3054R32
60"	F52M2460R31	F52M2460R32	F52M3060R31	F52M3060R32
66"	F52M2466R31	F52M2466R32	F52M3066R31	F52M3066R32
72"	F52M2472R31	F52M2472R32	F52M3072R31	F52M3072R32

Length	Left Hand 24" Deep Table		Left Hand 30" Deep Table	
	with Glides	with Casters	with Glides	with Casters
36"	F52M2436L31	F52M2436L32	F52M3036L31	F52M3036L32
42"	F52M2442L31	F52M2442L32	F52M3042L31	F52M3042L32
48"	F52M2448L31	F52M2448L32	F52M3048L31	F52M3048L32
54"	F52M2454L31	F52M2454L32	F52M3054L31	F52M3054L32
60"	F52M2460L31	F52M2460L32	F52M3060L31	F52M3060L32
66"	F52M2466L31	F52M2466L32	F52M3066L31	F52M3066L32
72"	F52M2472L31	F52M2472L32	F52M3072L31	F52M3072L32

Elevation Tables

Specifications:

The Alpha System Elevation Table is fabricated with a black painted steel frame and telescoping aluminum legs designed to carry a load of 400 pounds. Height is adjustable from 31" to 37". The table is available in a choice of three height adjustment methods. The height of the Manual Hydraulic Table is controlled by a folding crank located at the rear of the end frame. The height of the Motorized Hydraulic Table is controlled by a rocker

switch located at the front of the end frame. The table is also available with telescoping legs that are adjustable on 1" centers using a locking pin. All tables are furnished with stretchers and a 10" high modesty panel and are available with either glides or locking casters.

Elevation Table Work Tops must be ordered separately.

Elevation Table with Adjustable Height Legs

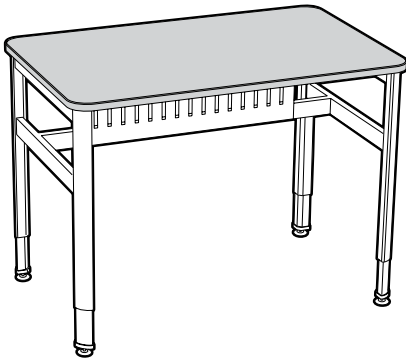

Length	24" Deep Table		30" Deep Table	
	with Glides	with Casters	with Glides	with Casters
36"	F52M2436-11	F52M2436-12	F52M3036-11	F52M3036-12
42"	F52M2442-11	F52M2442-12	F52M3042-11	F52M3042-12
48"	F52M2448-11	F52M2448-12	F52M3048-11	F52M3048-12
54"	F52M2454-11	F52M2454-12	F52M3054-11	F52M3054-12
60"	F52M2460-11	F52M2460-12	F52M3060-11	F52M3060-12
66"	F52M2466-11	F52M2466-12	F52M3066-11	F52M3066-12
72"	F52M2472-11	F52M2472-12	F52M3072-11	F52M3072-12

Elevation Tables Work Tops

Specifications:
 Elevation Table Work Tops are available in Kewaunee Kemresin, Phenolic Resin, or Plastic Laminate. Four corners on all Elevation Table Work Tops are rounded with a 2³/₄" radius to match the contour of the leg. See page 69 for available colors.

Elevation Tables must be ordered separately.

Elevation Table Work Tops

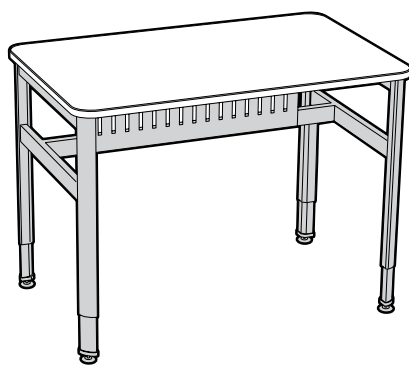

24" Deep Work Tops

Length	Kemresin	Phenolic Resin	Plastic Laminate
36"	F52R2436-00	F52T2436-00	F52P2436-00
42"	F52R2442-00	F52T2442-00	F52P2442-00
48"	F52R2448-00	F52T2448-00	F52P2448-00
54"	F52R2454-00	F52T2454-00	F52P2454-00
60"	F52R2460-00	F52T2460-00	F52P2460-00
66"	F52R2466-00	F52T2466-00	F52P2466-00
72"	F52R2472-00	F52T2472-00	F52P2472-00

30" Deep Work Tops

Length	Kemresin	Phenolic Resin	Plastic Laminate
36"	F52R3036-00	F52T3036-00	F52P3036-00
42"	F52R3042-00	F52T3042-00	F52P3042-00
48"	F52R3048-00	F52T3048-00	F52P3048-00
54"	F52R3054-00	F52T3054-00	F52P3054-00
60"	F52R3060-00	F52T3060-00	F52P3060-00
66"	F52R3066-00	F52T3066-00	F52P3066-00
72"	F52R3072-00	F52T3072-00	F52P3072-00

Work Top Color Option Code

Kemresin

BK = Black **GR** = Grey **PT**=Putty **SL** = Slate

Kemresin is available in four standard colors. To specify Kemresin color, place a dash and the two-letter code at the end of the part number.

Example: F52R2436-00-**BK** for Black

If no color is specified, Kemresin will be furnished in Black.

Phenolic Resin - High Pressure Laminate

Phenolic Resin and High Pressure Laminate is furnished in Black standard.

Free-Standing Adjustable Height Table

Specifications:

Free-Standing Adjustable Height Tables are available for either 24" deep or 30" deep worksurface tops in lengths as shown. Telescoping tubular steel legs allow the table to be height adjustable from 30" to 37" high on one inch increments. The table is furnished with a cold rolled steel frame and four adjustable legs with glides. Adjustable Height Tables will accommodate Suspended Cabinets.

Worksurface Top must be ordered separately.

Worksurface Tops are 1" thick. Front and side edges are treated as shown on page 69. Rear edge is finished square.

Free-Standing Adjustable Height Table Frame

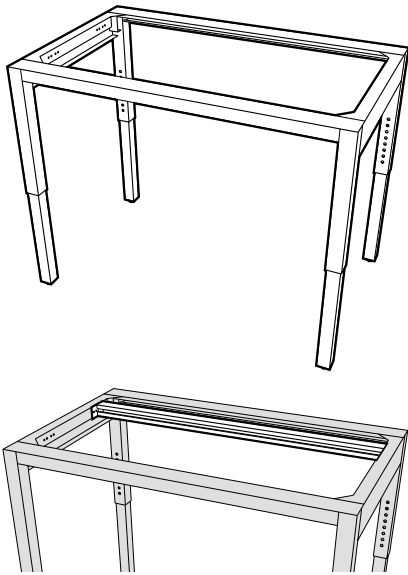

22" Deep Table Frame

Length	Part Number
34"	FC50M362234-00
40"	FC50M362240-00
46"	FC50M362246-00
52"	FC50M362252-00
58"	FC50M362258-00
64"	FC50M362264-00
70"	FC50M362270-00

28" Deep Table Frame

Length	Part Number
34"	FC50M362834-00
40"	FC50M362840-00
46"	FC50M362846-00
52"	FC50M362852-00
58"	FC50M362858-00
64"	FC50M362864-00
70"	FC50M362870-00

Optional Rear Hanging Rail

Length	Part Number
34"	FC89M020234-00
40"	FC89M020240-00
46"	FC89M020246-00
52"	FC89M020252-00
58"	FC89M020258-00
64"	FC89M020264-00
70"	FC89M020270-00

Required for 28" deep Table Frames only when mounting suspended cabinets.

Free-Standing Adjustable Height Table Top

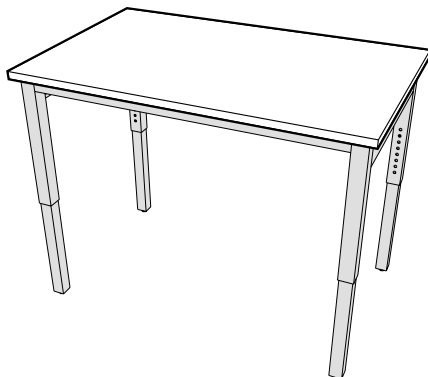

24" Deep Worksurface Top

Length	Kemresin®	Phenolic Resin	High Pressure Laminate
36"	FC96R012436-00	FC96T012436-00	FC96P012436-00
42"	FC96R012442-00	FC96T012442-00	FC96P012442-00
48"	FC96R012448-00	FC96T012448-00	FC96P012448-00
54"	FC96R012454-00	FC96T012454-00	FC96P012454-00
60"	FC96R012460-00	FC96T012460-00	FC96P012460-00
66"	FC96R012466-00	FC96T012466-00	FC96P012466-00
72"	FC96R012472-00	FC96T012472-00	FC96P012472-00

30" Deep Worksurface Top

Length	Kemresin®	Phenolic Resin	High Pressure Laminate
36"	FC96R013036-00	FC96T013036-00	FC96P013036-00
42"	FC96R013042-00	FC96T013042-00	FC96P013042-00
48"	FC96R013048-00	FC96T013048-00	FC96P013048-00
54"	FC96R013054-00	FC96T013054-00	FC96P013054-00
60"	FC96R013060-00	FC96T013060-00	FC96P013060-00
66"	FC96R013066-00	FC96T013066-00	FC96P013066-00
72"	FC96R013072-00	FC96T013072-00	FC96P013072-00

Floor Mounted Base Cabinets

Features:

Steel Base Cabinets

- Electrostatically applied, chemical resistant, powder coat finish available in colors to compliment the laboratory environment.
- One piece drawer body-bottom, back, sides and inner drawer head, radiused all four sides.
- Full-extension, side mounted, soft-close slides.
- One-piece case bottom and horizontal front rail.
- Flush face corner construction.
- Interchangeable doors and drawers.
- Five-knuckle institutional type stainless steel hinge, 2³/₄" high.

Wood Base Cabinets

- Multiple coat, chemical resistant finish system formulated to highlight the natural grain patterns.
- Dovetailed drawer construction with nine-ply hardwood plywood drawer sides.
- 3/4" seven-ply hardwood plywood end panels, bottom and shelf, with solid hardwood facing.
- Full-extension, ball bearing drawer slides
- One-piece 1/4" hardboard back, dadoed into end panels and bottom and securely fastened.
- Five-knuckle institutional type stainless steel offset door hinges rated for 150 pound loads.



Sitting Height Floor Mounted Base Cabinets

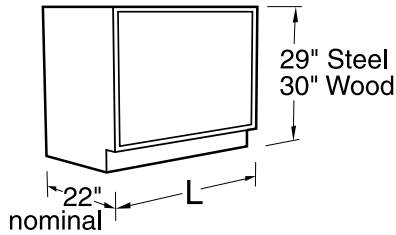

Specifications:

Steel Sitting Height Base Cabinets are 29" high and 22" deep. Wood cabinets are 30" high and a nominal 22" deep. Both available in lengths shown.

Open Cabinets have one full-depth adjustable shelf.

Cupboard cabinets have one full-depth adjustable shelf.

See page 98 and 99 for designating cabinet style, door and drawer head material, and hardware selection.

Open Base Cabinets

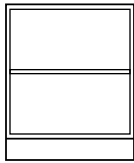

Steel Cabinet	Length	Wood Cabinet
B00C292215-00_0	15"	B00W312215-00_0
B00C292218-00_0	18"	B00W312218-00_0
B00C292221-00_0	21"	B00W312221-00_0
B00C292224-00_0	24"	B00W312224-00_0

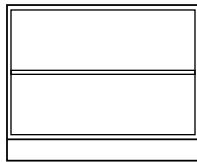
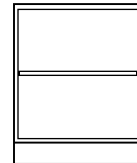

Steel Cabinet	Length	Wood Cabinet
B00C292230-00_0	30"	B00W312230-00_0
B00C292236-00_0	36"	B00W312236-00_0
B00C292242-00_0	42"	B00W312242-00_0
B00C292248-00_0	48"	B00W312248-00_0

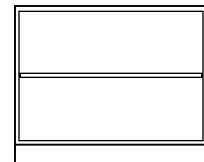

Cupboard Base Cabinets

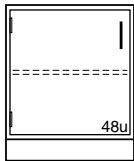

Steel Cabinet	Length	Wood Cabinet
C03C292215L	15"	C03W312215-L
C03C292218L	18"	C03W312218-L
C03C292221L	21"	C03W312221-L
C03C292224L	24"	C03W312224-L

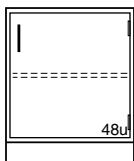
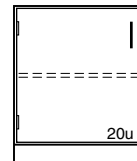

Steel Cabinet	Length	Wood Cabinet
C03C292215-	15"	C03W312215-
C03C292218-	18"	C03W312218-
C03C292221-	21"	C03W312221-
C03C292224-	24"	C03W312224-

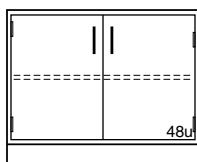
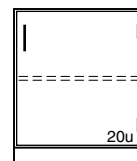

Steel Cabinet	Length	Wood Cabinet
C03C292230-	30"	C03W312230-
C03C292236-	36"	C03W312236-
C03C292242-	42"	C03W312242-
C03C292248-	48"	C03W312248-

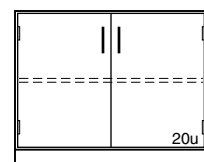

Drawer Base Cabinets

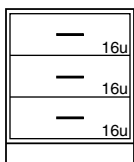

Steel Cabinet	Length	Wood Cabinet
D00C292215-	15"	D00W312215-_0
D00C292218-	18"	D00W312218-_0
D00C292221-	21"	D00W312221-_0
D00C292224-	24"	D00W312224-_0

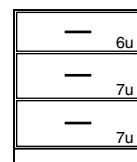

Sitting Height Floor Mounted Base Cabinets

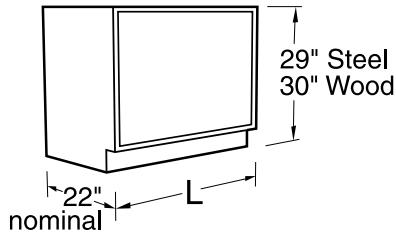

Specifications:

Steel Sitting Height Base Cabinets are 29" high and 22" deep. Wood cabinets are 30" high and a nominal 22" deep. Both available in lengths shown.

See page 98 and 99 for designating cabinet style, door and drawer head material, and hardware selection.

Drawer Base Cabinets

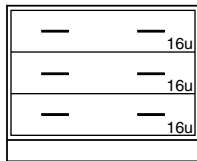

Steel Cabinet	Length	Wood Cabinet
D00C292230- -----	30"	D00W312230- 0 ----
D00C292236- -----	36"	D00W312236- 0 ----
D00C292242- -----	42"	D00W312242- 0 ----
D00C292248- -----	48"	D00W312248- 0 ----

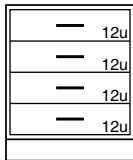
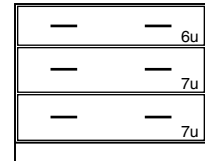

Steel Cabinet	Length	Wood Cabinet
D30C292215- -----	15"	D30W312215- 0 ----
D30C292218- -----	18"	D30W312218- 0 ----
D30C292221- -----	21"	D30W312221- 0 ----
D30C292224- -----	24"	D30W312224- 0 ----

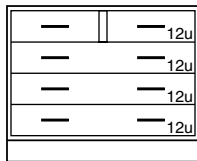
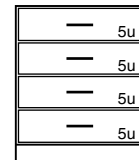

Steel Cabinet	Length	Wood Cabinet
D31C292230- -----	30"	D31W312230- 0 ----
D31C292236- -----	36"	D31W312236- 0 ----
D31C292242- -----	42"	D31W312242- 0 ----
D31C292248- -----	48"	D31W312248- 0 ----

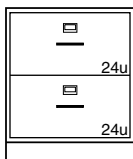
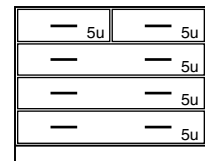

Steel Cabinet	Length	Wood Cabinet
D81C292218- -----	18"	D81W312218- 0 ----
D81C292221- -----	21"	D81W312221- 0 ----
D81C292224- -----	24"	D81W312224- 0 ----

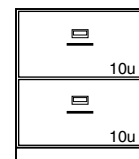

2 File Drawers with hangers

2 File Drawers with hangers

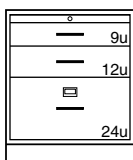

Steel Cabinet	Length	Wood Cabinet
D84C292218- -----	18"	D90W312218- 0 ----
D84C292221- -----	21"	D90W312221- 0 ----
D84C292224- -----	24"	D90W312224- 0 ----

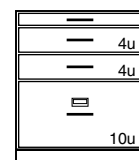

1 File Drawer with hangers

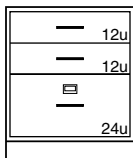

Steel Cabinet	Length	Wood Cabinet
D85C292218- -----	18"	D85W312218- 0 ----
D85C292221- -----	21"	D85W312221- 0 ----
D85C292224- -----	24"	D85W312224- 0 ----

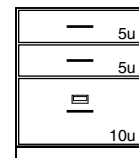

Pullboard
1 File Drawer with hangers

Pullboard
1 File Drawer with hangers

Sitting Height Floor Mounted Base Cabinets

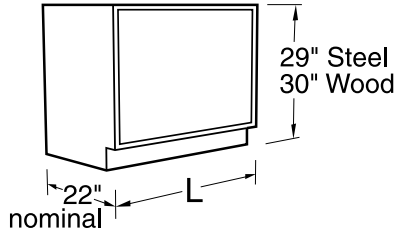

Specifications:

Steel Sitting Height Base Cabinets are 29" high and 22" deep. Wood cabinets are 30" high and a nominal 22" deep. Both available in lengths shown.

See page 98 and 99 for designating cabinet style, door and drawer head material, and hardware selection.

Drawer & Cupboard Base Cabinets

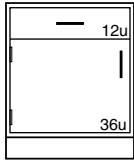

Steel Cabinet	Length	Wood Cabinet
E40C292215L -----	15"	E40W312215L -----
E40C292218L -----	18"	E40W312218L -----
E40C292221L -----	21"	E40W312221L -----
E40C292224L -----	24"	E40W312224L -----

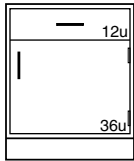
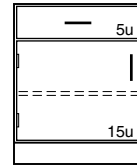

Steel Cabinet	Length	Wood Cabinet
E40C292215- -----	15"	E40W312215- -----
E40C292218- -----	18"	E40W312218- -----
E40C292221- -----	21"	E40W312221- -----
E40C292224- -----	24"	E40W312224- -----

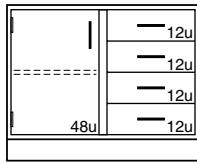
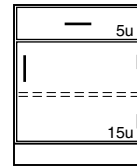

Steel Cabinet	Length	Wood Cabinet
E45C292230L -----	30"	E45W312230L -----
E45C292236L -----	36"	E45W312236L -----
E45C292242L -----	42"	E45W312242L -----
E45C292248L -----	48"	E45W312248L -----

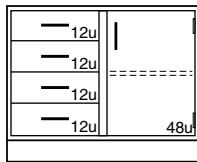
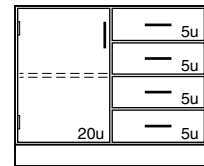

Steel Cabinet	Length	Wood Cabinet
E45C292230- -----	30"	E45W312230- -----
E45C292236- -----	36"	E45W312236- -----
E45C292242- -----	42"	E45W312242- -----
E45C292248- -----	48"	E45W312248- -----

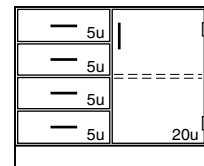

ADA Height Floor Mounted Base Cabinets

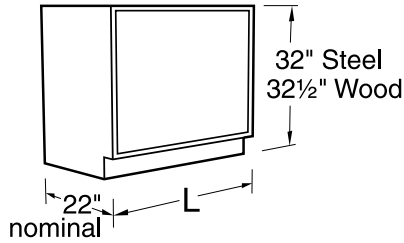

Specifications:

Steel ADA Height Base Cabinets are 32" high and 22" deep. Wood cabinets are 32½" high and a nominal 22" deep. Both available in lengths shown. Open Cabinets have one full-depth adjustable shelf.

Cupboard cabinets have one full-depth adjustable shelf.

See page 98 and 99 for designating cabinet style, door and drawer head material, and hardware selection.

Cupboard Base Cabinets

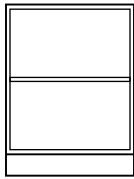

Steel Cabinet	Length	Wood Cabinet
C03C322215L	15"	C03W342215L
C03C322218L	18"	C03W342218L
C03C322221L	21"	C03W342221L
C03C322224L	24"	C03W342224L

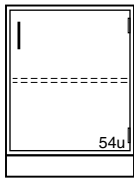
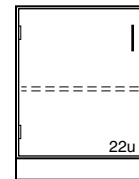

Steel Cabinet	Length	Wood Cabinet
C03C322215-	15"	C03W342215-
C03C322218-	18"	C03W342218-
C03C322221-	21"	C03W342221-
C03C322224-	24"	C03W342224-

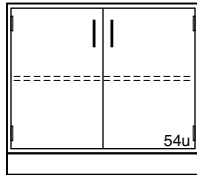
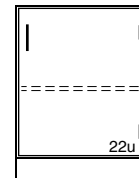

Steel Cabinet	Length	Wood Cabinet
C03C322230-	30"	C03W342230-
C03C322236-	36"	C03W342236-
C03C322242-	42"	C03W342242-
C03C322248-	48"	C03W342248-

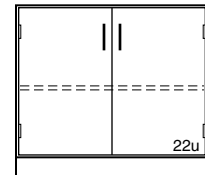

Drawer Base Cabinets

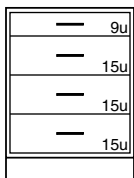

Steel Cabinet	Length	Wood Cabinet
D30C322215-	15"	D30W342215- 0
D30C322218-	18"	D30W342218- 0
D30C322221-	21"	D30W342221- 0
D30C322224-	24"	D30W342224- 0

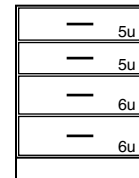

Drawer & Cupboard Base Cabinets

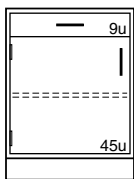

Steel Cabinet	Length	Wood Cabinet
E40C322215L	15"	E40W342215L
E40C322218L	18"	E40W342218L
E40C322221L	21"	E40W342221L
E40C322224L	24"	E40W342224L

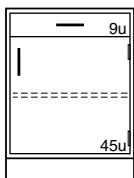
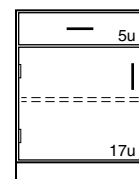

Steel Cabinet	Length	Wood Cabinet
E40C322215-	15"	E40W342215-
E40C322218-	18"	E40W342218-
E40C322221-	21"	E40W342221-
E40C322224-	24"	E40W342224-

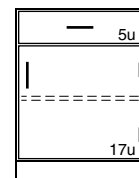

ADA Height Floor Mounted Base Cabinets

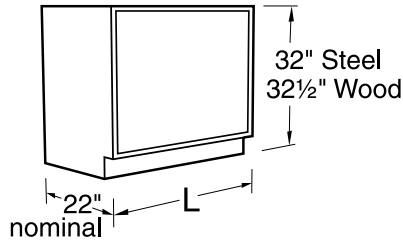

Specifications:

Steel ADA Height Base Cabinets are 32" high and 22" deep. Wood cabinets are 32½" high and a nominal 22" deep. Both available in lengths shown. Open Cabinets have one full-depth adjustable shelf.

Cupboard cabinets have one full-depth adjustable shelf.

See page 98 and 99 for designating cabinet style, door and drawer head material, and hardware selection.

Drawer & Cupboard Base Cabinets

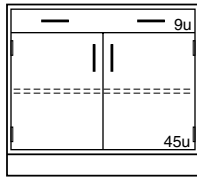

Steel Cabinet	Length	Wood Cabinet
E40C322230-	30"	E40W342230-
E40C322236-	36"	E40W342236-
E40C322242-	42"	E40W342242-
E40C322248-	48"	E40W342248-

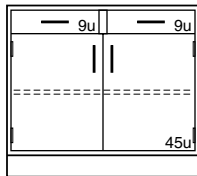
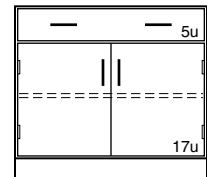

Steel Cabinet	Length	Wood Cabinet
E41C322230-	30"	E41W342230-
E41C322236-	36"	E41W342236-
E41C322242-	42"	E41W342242-
E41C322248-	48"	E41W342248-

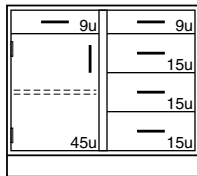
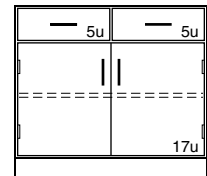

Steel Cabinet	Length	Wood Cabinet
E43C322230L	30"	E43W342230L
E43C322236L	36"	E43W342236L
E43C322242L	42"	E43W342242L
E43C322248L	48"	E43W342248L

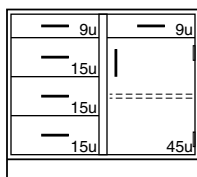
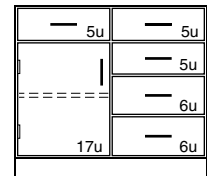

Steel Cabinet	Length	Wood Cabinet
E43C322230-	30"	E43W342230-
E43C322236-	36"	E43W342236-
E43C322242-	42"	E43W342242-
E43C322248-	48"	E43W342248-

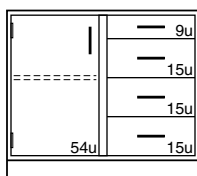
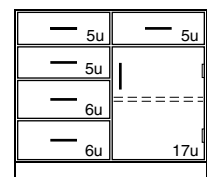

Steel Cabinet	Length	Wood Cabinet
E45C322230L	30"	E45W342230L
E45C322236L	36"	E45W342236L
E45C322242L	42"	E45W342242L
E45C322248L	48"	E45W342248L

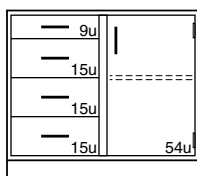
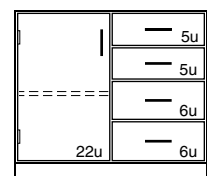

Steel Cabinet	Length	Wood Cabinet
E45C322230-	30"	E45W342230-
E45C322236-	36"	E45W342236-
E45C322242-	42"	E45W342242-
E45C322248-	48"	E45W342248-

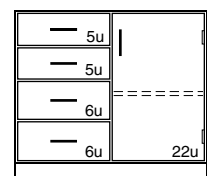

ADA Height Floor Mounted Base Cabinets

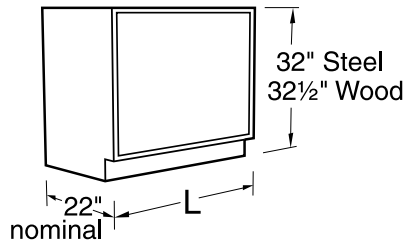

Specifications:
 Steel ADA Height Base Cabinets are 32" high and 22" deep. Wood cabinets are 32½" high and a nominal 22" deep. Both available in lengths shown.
 See page 98 and 99 for designating cabinet style, door and drawer head material, and hardware selection.

Sink Base Cabinets

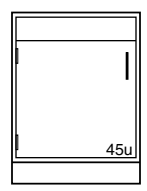

Steel Cabinet	Length	Wood Cabinet
G00C322215L -----	15"	G00W342215L -----
G00C322218L -----	18"	G00W342218L -----
G00C322221L -----	21"	G00W342221L -----
G00C322224L -----	24"	G00W342224L -----

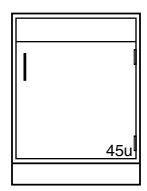
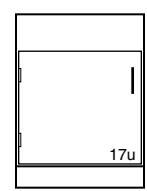

Steel Cabinet	Length	Wood Cabinet
G00C322215- -----	15"	G00W342215- -----
G00C322218- -----	18"	G00W342218- -----
G00C322221- -----	21"	G00W342221- -----
G00C322224- -----	24"	G00W342224- -----

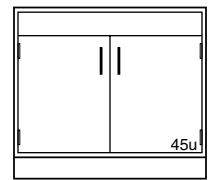
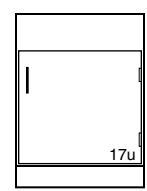

Steel Cabinet	Length	Wood Cabinet
G00C322230- -----	30"	G00W342230- -----
G00C322236- -----	36"	G00W342236- -----
G00C322242- -----	42"	G00W342242- -----
G00C322248- -----	48"	G00W342248- -----

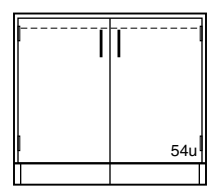
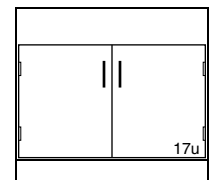

Steel Cabinet	Length	Wood Cabinet
G03C322230- -----	30"	G03W342230- -----
G03C322236- -----	36"	G03W342236- -----
G03C322242- -----	42"	G03W342242- -----
G03C322248- -----	48"	G03W342248- -----

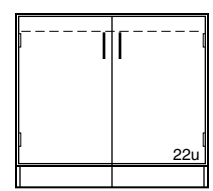

No Cabinet Bottom
 Toe space rails attached to bottom of doors

Standing Height Floor Mounted Cabinets

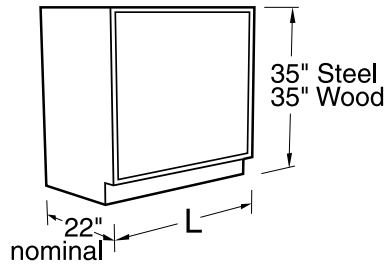

Specifications:

Steel Standing Height Base Cabinets are 35" high and 22" deep. Wood cabinets are 35" high and a nominal 22" deep. Both available in lengths shown.

Open Cabinets have two full-depth adjustable shelves.

Cupboard cabinets have one full-depth adjustable shelf.

See page 98 and 99 for designating cabinet style, door and drawer head material, and hardware selection.

Open Base Cabinets

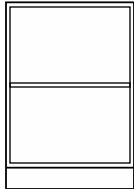

Steel Cabinet	Length	Wood Cabinet
B00C352215-00_0	15"	B00W362215-00_0
B00C352218-00_0	18"	B00W362218-00_0
B00C352221-00_0	21"	B00W362221-00_0
B00C352224-00_0	24"	B00W362224-00_0

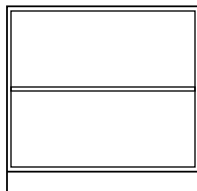
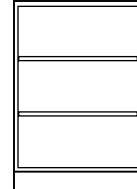

Steel Cabinet	Length	Wood Cabinet
B00C352230-00_0	30"	B00W362230-00_0
B00C352236-00_0	36"	B00W362236-00_0
B00C352242-00_0	42"	B00W362242-00_0
B00C352248-00_0	48"	B00W362248-00_0

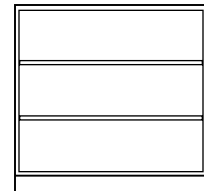

Cupboard Base Cabinets

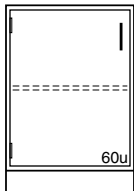

Steel Cabinet	Length	Wood Cabinet
C03C352215L	15"	C03W362215L
C03C352218L	18"	C03W362218L
C03C352221L	21"	C03W362221L
C03C352224L	24"	C03W362224L

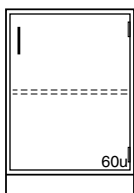
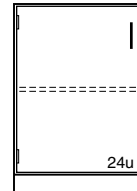

Steel Cabinet	Length	Wood Cabinet
C03C352215-	15"	C03W362215-
C03C352218-	18"	C03W362218-
C03C352221-	21"	C03W362221-
C03C352224-	24"	C03W362224-

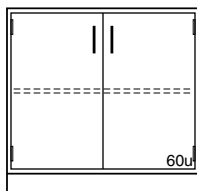

Steel Cabinet	Length	Wood Cabinet
C03C352230-	30"	C03W362230-
C03C352236-	36"	C03W362236-
C03C352242-	42"	C03W362242-
C03C352248-	48"	C03W362248-

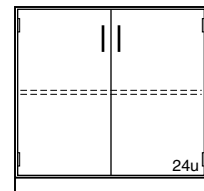

Drawer Base Cabinets

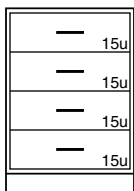

Steel Cabinet	Length	Wood Cabinet
D30C352215-	15"	D30W362215- 0
D30C352218-	18"	D30W362218- 0
D30C352221-	21"	D30W362221- 0
D30C352224-	24"	D30W362224- 0

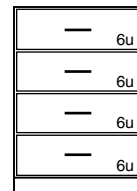

Standing Height Floor Mounted Cabinets

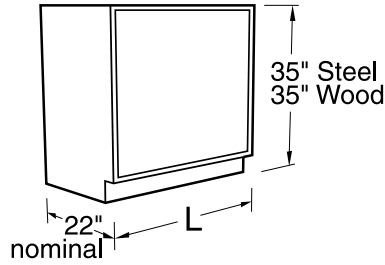

Specifications:

Steel Standing Height Base Cabinets are 35" high and 22" deep. Wood cabinets are 35" high and a nominal 22" deep. Both available in lengths shown.

See page 98 and 99 for designating cabinet style, door and drawer head material, and hardware selection.

Drawer Base Cabinets

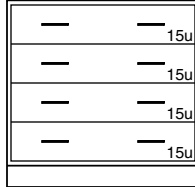

Steel Cabinet	Length	Wood Cabinet
D30C352230- -----	30"	D30W362230- 0 -----
D30C352236- -----	36"	D30W362236- 0 -----
D30C352242- -----	42"	D30W362242- 0 -----
D30C352248- -----	48"	D30W362248- 0 -----

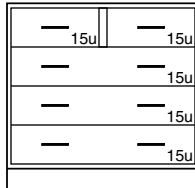
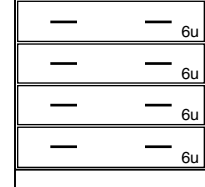

Steel Cabinet	Length	Wood Cabinet
D31C352230- -----	30"	D31W362230- 0 -----
D31C352236- -----	36"	D31W362236- 0 -----
D31C352242- -----	42"	D31W362242- 0 -----
D31C352248- -----	48"	D31W362248- 0 -----

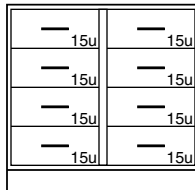
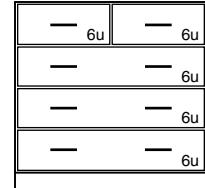

Steel Cabinet	Length	Wood Cabinet
D32C352230- -----	30"	D32W362230- 0 -----
D32C352236- -----	36"	D32W362236- 0 -----
D32C352242- -----	42"	D32W362242- 0 -----
D32C352248- -----	48"	D32W362248- 0 -----

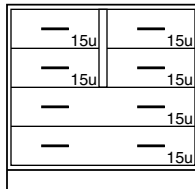
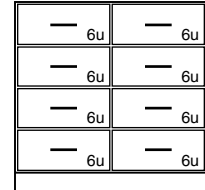

Steel Cabinet	Length	Wood Cabinet
D36C352230- -----	30"	D36W362230- 0 -----
D36C352236- -----	36"	D36W362236- 0 -----
D36C352242- -----	42"	D36W362242- 0 -----
D36C352248- -----	48"	D36W362248- 0 -----

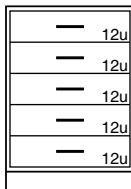
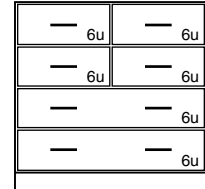

Steel Cabinet	Length	Wood Cabinet
D50C352215- -----	15"	D50W362215- 0 -----
D50C352218- -----	18"	D50W362218- 0 -----
D50C352221- -----	21"	D50W362221- 0 -----
D50C352224- -----	24"	D50W362224- 0 -----

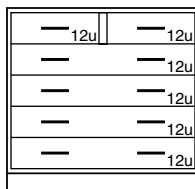
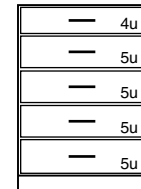

Steel Cabinet	Length	Wood Cabinet
D51C352230- -----	30"	D51W362230- 0 -----
D51C352236- -----	36"	D51W362236- 0 -----
D51C352242- -----	42"	D51W362242- 0 -----
D51C352248- -----	48"	D51W362248- 0 -----

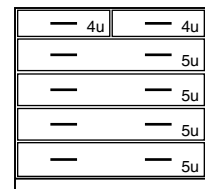

Standing Height Floor Mounted Cabinets

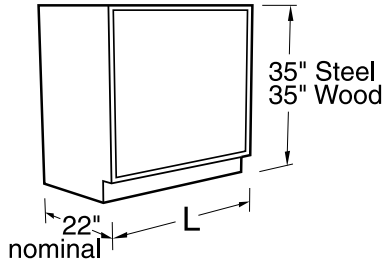

Specifications:

Steel Standing Height Base Cabinets are 35" high and 22" deep. Wood cabinets are 35" high and a nominal 22" deep. Both available in lengths shown.

See page 98 and 99 for designating cabinet style, door and drawer head material, and hardware selection.

Drawer Base Cabinets

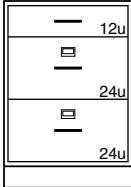

2 File Drawers with hangers

Steel Cabinet	Length	Wood Cabinet
D81C352215- -----	15"	D81W362215- 0 -----
D81C352218- -----	18"	D81W362218- 0 -----
D81C352221- -----	21"	D81W362221- 0 -----
D81C352224- -----	24"	D81W362224- 0 -----

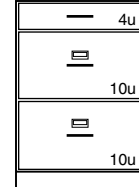

2 File Drawers with hangers

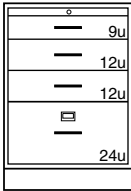

Pullboard
1 File Drawer with hangers

Steel Cabinet	Length	Wood Cabinet
D84C352215- -----	15"	D84W362215- 0 -----
D84C352218- -----	18"	D84W362218- 0 -----
D84C352221- -----	21"	D84W362221- 0 -----
D84C352224- -----	24"	D84W362224- 0 -----

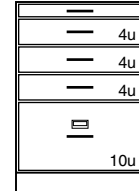

Pullboard
1 File Drawer with hangers

Drawer & Cupboard Base Cabinets

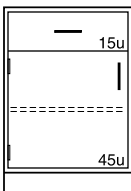

Steel Cabinet	Length	Wood Cabinet
E40C352215L -----	15"	E40W362215L -----
E40C352218L -----	18"	E40W362218L -----
E40C352221L -----	21"	E40W362221L -----
E40C352224L -----	24"	E40W362224L -----

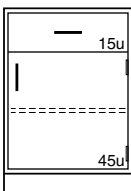
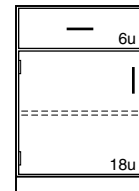

Steel Cabinet	Length	Wood Cabinet
E40C352215- -----	15"	E40W362215- -----
E40C352218- -----	18"	E40W362218- -----
E40C352221- -----	21"	E40W362221- -----
E40C352224- -----	24"	E40W362224- -----

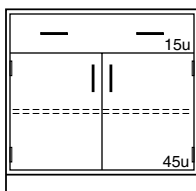
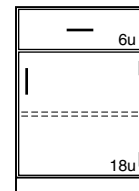

Steel Cabinet	Length	Wood Cabinet
E40C352230- -----	30"	E40W362230- -----
E40C352236- -----	36"	E40W362236- -----
E40C352242- -----	42"	E40W362242- -----
E40C352248- -----	48"	E40W362248- -----

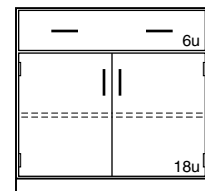

Standing Height Floor Mounted Cabinets

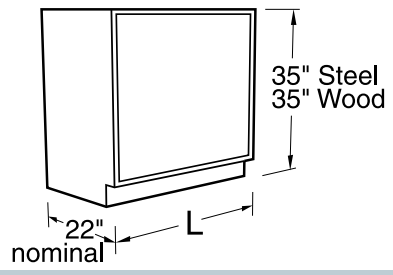

Specifications:
 Steel Standing Height Base Cabinets are 35" high and 22" deep. Wood cabinets are 35" high and a nominal 22" deep. Both available in lengths shown.

Cupboards have one full-depth adjustable shelf.

See page 98 and 99 for designating cabinet style, door and drawer head material, and hardware selection.

Drawer & Cupboard Base Cabinets

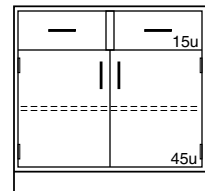

Steel Cabinet	Length	Wood Cabinet
E41C352230- -----	30"	E41W362230- -----
E41C352236- -----	36"	E41W362236- -----
E41C352242- -----	42"	E41W362242- -----
E41C352248- -----	48"	E41W362248- -----

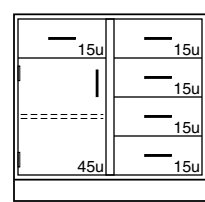
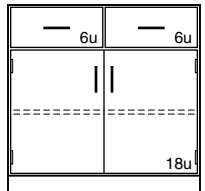

Steel Cabinet	Length	Wood Cabinet
E43C352230L -----	30"	E43W362230L -----
E43C352236L -----	36"	E43W362236L -----
E43C352242L -----	42"	E43W362242L -----
E43C352248L -----	48"	E43W362248L -----

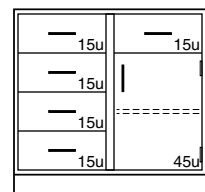
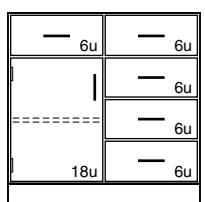

Steel Cabinet	Length	Wood Cabinet
E43C352230- -----	30"	E43W362230- -----
E43C352236- -----	36"	E43W362236- -----
E43C352242- -----	42"	E43W362242- -----
E43C352248- -----	48"	E43W362248- -----

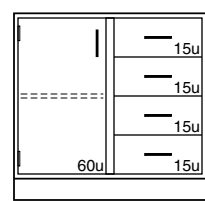
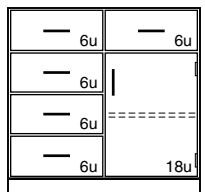

Steel Cabinet	Length	Wood Cabinet
E45C352230L -----	30"	E45W362230L -----
E45C352236L -----	36"	E45W362236L -----
E45C352242L -----	42"	E45W362242L -----
E45C352248L -----	48"	E45W362248L -----

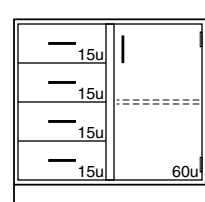
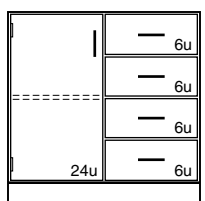

Steel Cabinet	Length	Wood Cabinet
E45C352230- -----	30"	E45W362230- -----
E45C352236- -----	36"	E45W362236- -----
E45C352242- -----	42"	E45W362242- -----
E45C352248- -----	48"	E45W362248- -----

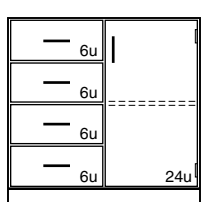

Standing Height Floor Mounted Cabinets

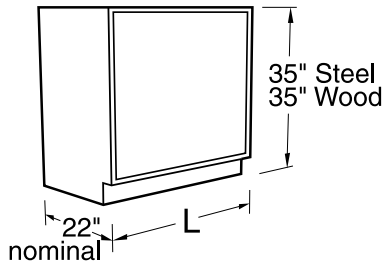

Specifications:

Steel Standing Height Base Cabinets are 35" high and 22" deep. Wood cabinets are 35" high and a nominal 22" deep. Both available in lengths shown.

Cupboards have one full-depth adjustable shelf.

See page 98 and 99 for designating cabinet style, door and drawer head material, and hardware selection.

Drawer & Cupboard Base Cabinets

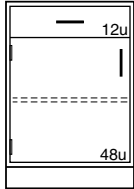

Steel Cabinet	Length	Wood Cabinet
E60C352215L	15"	E60W362215L
E60C352218L	18"	E60W362218L
E60C352221L	21"	E60W362221L
E60C352224L	24"	E60W362224L

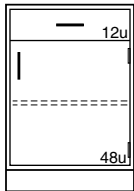
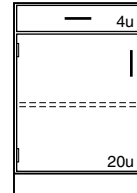

Steel Cabinet	Length	Wood Cabinet
E60C352215-	15"	E60W362215-
E60C352218-	18"	E60W362218-
E60C352221-	21"	E60W362221-
E60C352224-	24"	E60W362224-

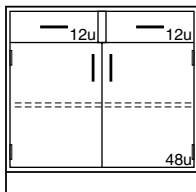
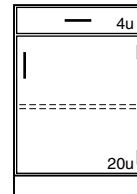

Steel Cabinet	Length	Wood Cabinet
E61C352230-	30"	E61W362230-
E61C352236-	36"	E61W362236-
E61C352242-	42"	E61W362242-
E61C352248-	48"	E61W362248-

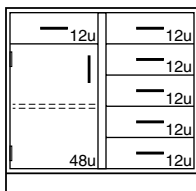
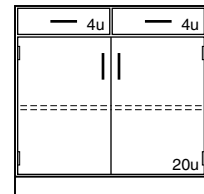

Steel Cabinet	Length	Wood Cabinet
E63C352230L	30"	E63W362230L
E63C352236L	36"	E63W362236L
E63C352242L	42"	E63W362242L
E63C352248L	48"	E63W362248L

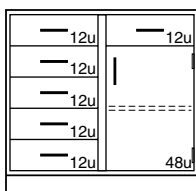
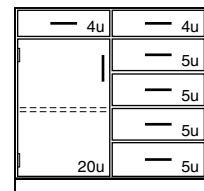

Steel Cabinet	Length	Wood Cabinet
E63C352230-	30"	E63W362230-
E63C352236-	36"	E63W362236-
E63C352242-	42"	E63W362242-
E63C352248-	48"	E63W362248-

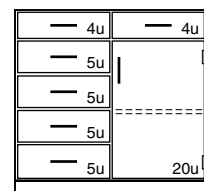

Standing Height Floor Mounted Cabinets

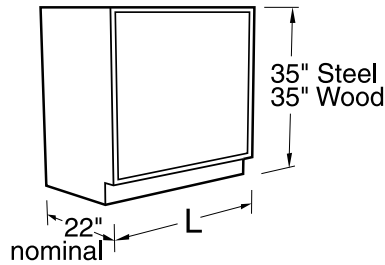

Specifications:

Steel Standing Height Base Cabinets are 35" high and 22" deep. Wood cabinets are 35" high and a nominal 22" deep. Both available in lengths shown.

Cupboards have one full-depth adjustable shelf.

See page 98 and 99 for designating cabinet style, door and drawer head material, and hardware selection.

Drawer & Cupboard Base Cabinets

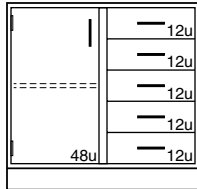

Steel Cabinet	Length	Wood Cabinet
E65C352230L	30"	E65W362230L
E65C352236L	36"	E65W362236L
E65C352242L	42"	E65W362242L
E65C352248L	48"	E65W362248L

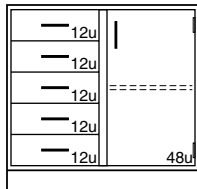
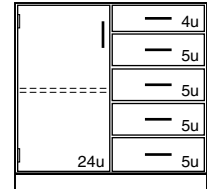

Steel Cabinet	Length	Wood Cabinet
E65C352230-	30"	E65W362230-
E65C352236-	36"	E65W362236-
E65C352242-	42"	E65W362242-
E65C352248-	48"	E65W362248-

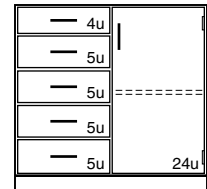

Sink Base Cabinets

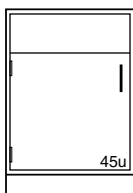

Steel Cabinet	Length	Wood Cabinet
G00C352215L	15"	G00W362215L
G00C352218L	18"	G00W362218L
G00C352221L	21"	G00W362221L
G00C352224L	24"	G00W362224L

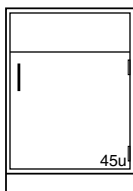
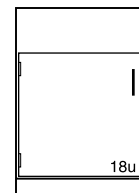

Steel Cabinet	Length	Wood Cabinet
G00C352215-	15"	G00W362215-
G00C352218-	18"	G00W362218-
G00C352221-	21"	G00W362221-
G00C352224-	24"	G00W362224-

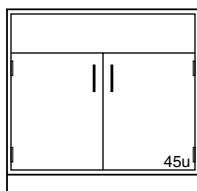
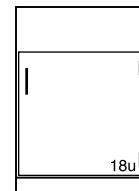

Steel Cabinet	Length	Wood Cabinet
G00C352230-	30"	G00W362230-
G00C352236-	36"	G00W362236-
G00C352242-	42"	G00W362242-
G00C352248-	48"	G00W362248-

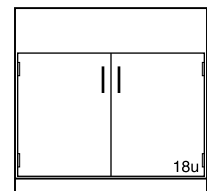

Standing Height Floor Mounted Cabinets

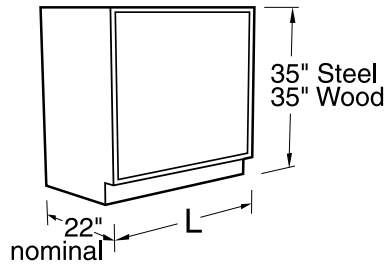

Specifications:

Steel Standing Height Base Cabinets are 35" high and 22" deep. Wood cabinets are 35" high and a nominal 22" deep. Both available in lengths shown.

See page 98 and 99 for designating cabinet style, door and drawer head material, and hardware selection.

Sink Base Cabinets

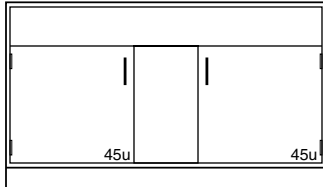

Steel Cabinet	Length	Wood Cabinet
G00C352260- -----	60"	G01W362260- -----

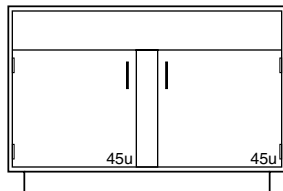
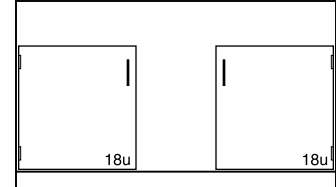

Steel Cabinet	Length	Wood Cabinet
G04C352252- -----	52"	G04W362252- -----
G04C352258- -----	58"	G04W362258- -----
G04C352260- -----	60"	G04W362260- -----

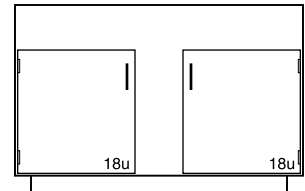

Fume Hood Base Cabinets

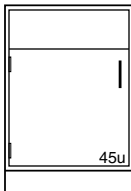

Steel Cabinet	Length	Wood Cabinet
G08C352215L -----	15"	G08W362215L -----
G08C352218L -----	18"	G08W362218L -----
G08C352221L -----	21"	G08W362221L -----
G08C352224L -----	24"	G08W362224L -----

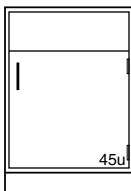
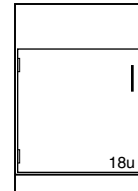

Steel Cabinet	Length	Wood Cabinet
G08C352215- -----	15"	G08W362215- -----
G08C352218- -----	18"	G08W362218- -----
G08C352221- -----	21"	G08W362221- -----
G08C352224- -----	24"	G08W362224- -----

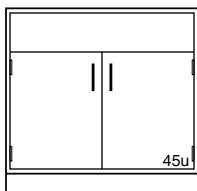
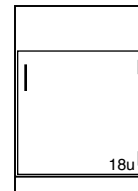

Steel Cabinet	Length	Wood Cabinet
G08C352230- -----	30"	G08W362230- -----
G08C352236- -----	36"	G08W362236- -----
G08C352242- -----	42"	G08W362242- -----
G08C352248- -----	48"	G08W362248- -----

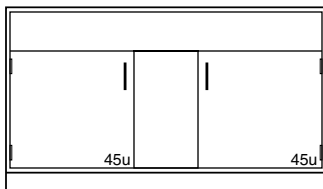
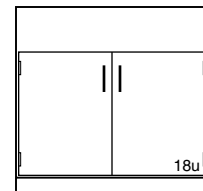

Steel Cabinet	Length	Wood Cabinet
G08C352260- -----	60"	G08W362260- -----

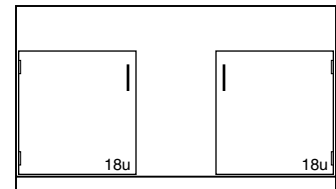

Standing Height Floor Mounted Cabinets

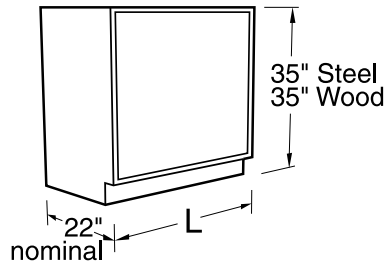

Specifications:

Steel Standing Height Base Cabinets are 35" high and 22" deep. Wood cabinets are 35" high and a nominal 22" deep. Both available in lengths shown.

Fume Hood Acid Storage Base Cabinets are manufactured with a

one-piece polyethylene corrosion resistant lining and are provided with a PVC vent.

See page 98 and 99 for designating cabinet style, door and drawer head material, and hardware selection.

Fume Hood Acid Storage Base Cabinets

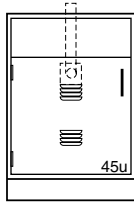

Steel Cabinet	Length	Wood Cabinet
G80C352224L _____	24"	G80W362224L _____

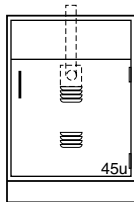
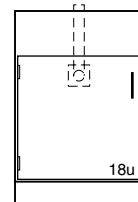

Steel Cabinet	Length	Wood Cabinet
G80C352224- _____	24"	G80W362224- _____

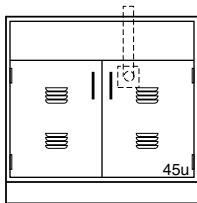
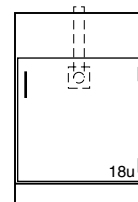

Steel Cabinet	Length	Wood Cabinet
G80C352230- _____	30"	G80W362230- _____
G80C352236- _____	36"	G80W362236- _____
G80C352248- _____	48"	G80W362248- _____

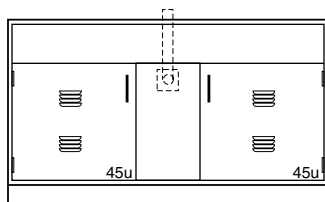
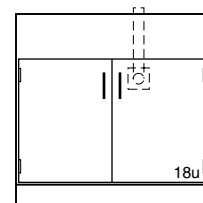

Steel Cabinet	Length	Wood Cabinet
G80C352260- _____	60"	G80W362260- _____

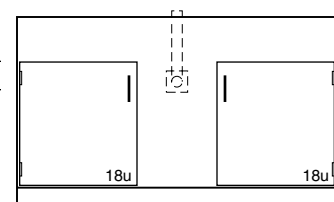

Diagonal Corner Base Cabinets

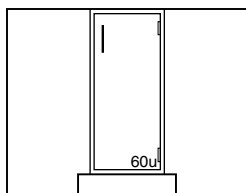

Steel Cabinet	Length	Wood Cabinet
G14C352214- _____	12" - 32"	G14W362214- _____

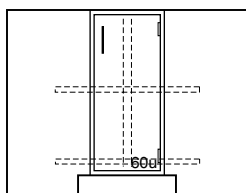
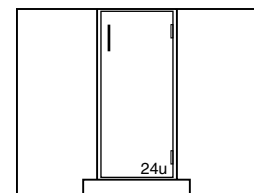

Steel Cabinet	Length	Wood Cabinet
G15C352214- _____	12" - 32"	G15W362214- _____

Provided with Lazy Susan

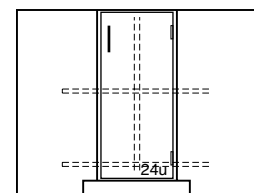

Standing Height Floor Mounted Cabinets

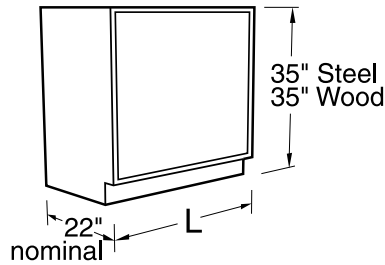

Specifications:

Solvent Storage Base Cabinets, are UL listed, 35" high, and a nominal 22" deep. Lengths as shown. They are specifically designed for the storage of flammable and combustible liquids. Solvent Storage Cabinets are provided with self-closing, self-

latching doors, and meet UFC, OSHA and NFPA No.30-1993 requirements.

Steel is available in Style 0 and 1 only, Wood is available in Styles 1 and 5 only.

Solvent Storage Base Cabinets

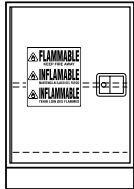

Steel Cabinet	Length	Wood Cabinet
G63C352224L_100	24"	G63W362224L_0_0

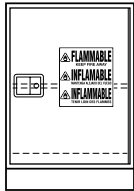
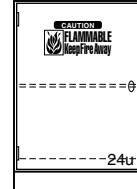

Steel Cabinet	Length	Wood Cabinet
G63C352224-_100	24"	G63W362224-_0_0

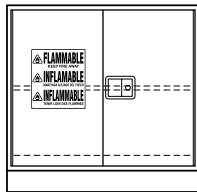
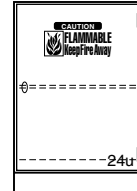

Steel Cabinet	Length	Wood Cabinet
G63C352230-_100	30"	G63W362230-_0_0
G63C352236-_100	36"	G63W362236-_0_0
G63C352248-_100	48"	G63W362248-_0_0

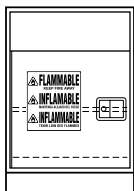
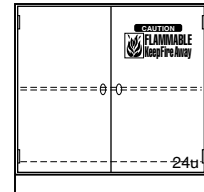

Steel Cabinet	Length	Wood Cabinet
G68C352224L_100	24"	G68W362224L_0_0

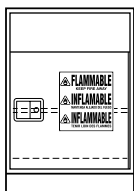
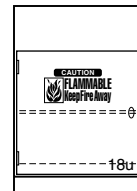

Steel Cabinet	Length	Wood Cabinet
G68C352224-_100	24"	G68W362224-_0_0

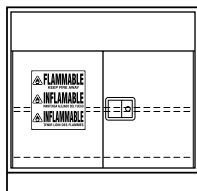
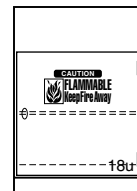

Steel Cabinet	Length	Wood Cabinet
G68C352230-_100	30"	G68W362230-_0_0
G68C352236-_100	36"	G68W362236-_0_0
G68C352248-_100	48"	G68W362248-_0_0

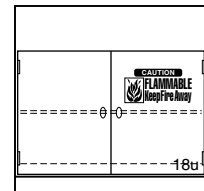

Mobile Base Cabinets

Features:

Steel Base Cabinets

- Furnished with finished ends and back.
- Cabinet tops available in either, Kemresin, Phenolic Resin, High Pressure Laminate or Steel.
- Furnished with two concealed, fixed casters at rear, and two swivel, locking casters at front.
- Furnished with interlocking drawer system and counterbalanced weights in drawer cabinets.
- Available in all steel cabinet styles, in both inset and full overlay.

Wood Base Cabinets

- Furnished with finished veneer top, end panels, and back. End panels banded and finished, front, back, top, and bottom.
- Optional 1" thick cabinet tops available. (recommended for wood cabinets with pullboards)
- Furnished with two concealed, fixed casters at rear, and two swivel, locking casters at front.
- Furnished with interlocking drawer system and counterbalanced weights in drawer cabinets.
- Available in three wood cabinet styles in Oak, Maple, or Beech veneer.

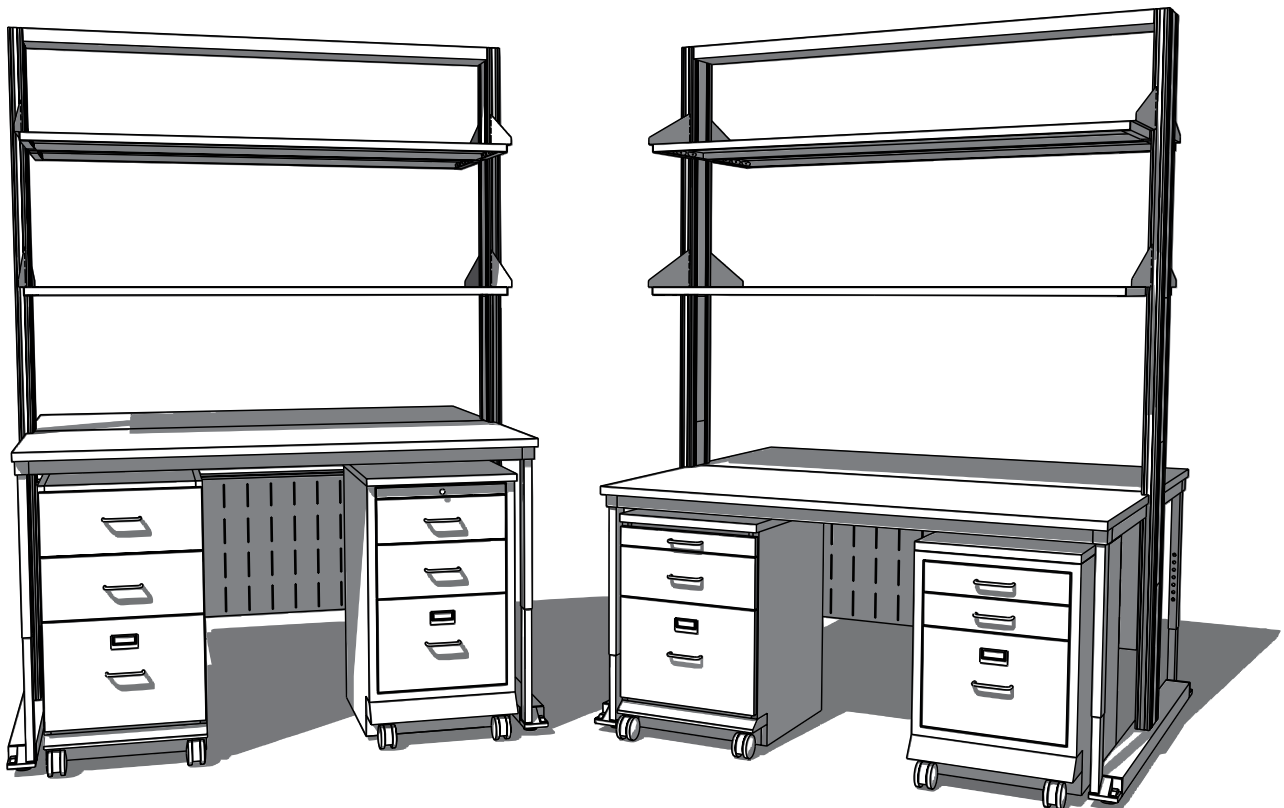

Wood Sitting Height Mobile Cabinets

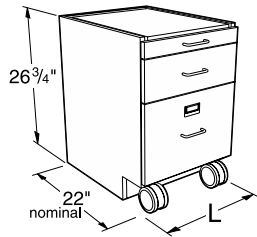

Specifications:

These Mobile Cabinets are 26³/₄" high and a nominal 22" deep. Lengths as shown. They are designed to fit under 30" high worksurface frames.

Drawer cabinets are furnished with counter weights, multiple-drawer cabinets include an interlock system. All mobile cabinets have finished backs.

Note: Last four digits of part number designates door and drawer head style, hinge, hardwood species, and pull selection. See page 99 for full explanation. Actual product may vary slightly from catalog illustration due to style and hardware selection.

Cupboard Cabinets

Cupboard Cabinets with Pullboards

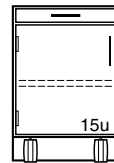
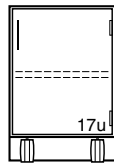
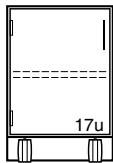

M10W272215L _____ 15"
 M10W272218L _____ 18"
 M10W272221L _____ 21"
 M10W272224L _____ 24"

M10W272215- _____ 15"
 M10W272218- _____ 18"
 M10W272221- _____ 21"
 M10W272224- _____ 24"

M15W272215L _____ 15"
 M15W272218L _____ 18"
 M15W272221L _____ 21"
 M15W272224L _____ 24"

M15W272215- _____ 15"
 M15W272218- _____ 18"
 M15W272221- _____ 21"
 M15W272224- _____ 24"

Drawer/Cupboard Cabinets

Drawer/Cupboard Cabinets with Pullboards

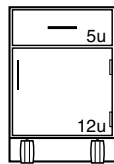
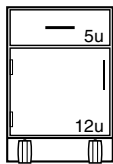

M20W272215L _____ 15"
 M20W272218L _____ 18"
 M20W272221L _____ 21"
 M20W272224L _____ 24"

M20W272215- _____ 15"
 M20W272218- _____ 18"
 M20W272221- _____ 21"
 M20W272224- _____ 24"

M25W272215L _____ 15"
 M25W272218L _____ 18"
 M25W272221L _____ 21"
 M25W272224L _____ 24"

M25W272215- _____ 15"
 M25W272218- _____ 18"
 M25W272221- _____ 21"
 M25W272224- _____ 24"

Drawer Cabinets

Drawer Cabinets with Pullboards

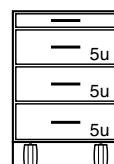
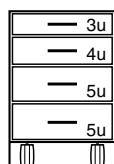
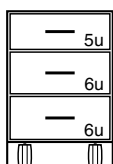

M30W272215- _____ 15"
 M30W272218- _____ 18"
 M30W272221- _____ 21"
 M30W272224- _____ 24"

M40W272215- _____ 15"
 M40W272218- _____ 18"
 M40W272221- _____ 21"
 M40W272224- _____ 24"

M35W272215- _____ 15"
 M35W272218- _____ 18"
 M35W272221- _____ 21"
 M35W272224- _____ 24"

Note: Wood Mobile Cabinets are constructed with finished top panels. Tops may be added but are not required to close the top of the cabinet.

Tops are recommended on wood mobile cabinets with pullboards.

Tops must be ordered separately. (see page 133)

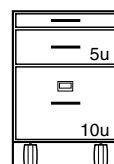
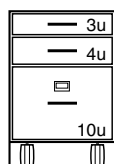
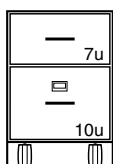

M60W272215- _____ 15"
 M60W272218- _____ 18"
 M60W272221- _____ 21"
 M60W272224- _____ 24"

M62W272215- _____ 15"
 M62W272218- _____ 18"
 M62W272221- _____ 21"
 M62W272224- _____ 24"

M65W272215- _____ 15"
 M65W272218- _____ 18"
 M65W272221- _____ 21"
 M65W272224- _____ 24"

Wood Standing Height Mobile Cabinets

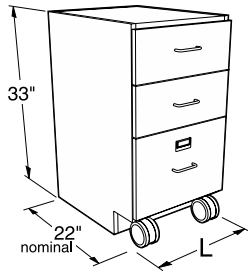

Specifications:

These Mobile Cabinets are 33" high and a nominal 22" deep. Lengths as shown. They are designed to fit under 36" high worksurface frames.

Drawer cabinets are furnished with counter weights, multiple-drawer cabinets include an interlock system. All mobile cabinets have finished backs.

Note: Last four digits of part number designates door and drawer head style, hinge, hardwood species, and pull selection. See page 99 for full explanation. Actual product may vary slightly from catalog illustration due to style and hardware selection.

Cupboard Cabinets

Cupboard Cabinets with Pullboards

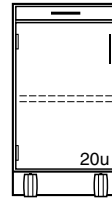
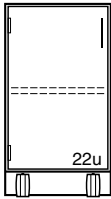

M10W332215L _____ 15"L
 M10W332218L _____ 18"L
 M10W332221L _____ 21"L
 M10W332224L _____ 24"L

M10W332215- _____ 15"L
 M10W332218- _____ 18"L
 M10W332221- _____ 21"L
 M10W332224- _____ 24"L

M15W332215L _____ 15"L
 M15W332218L _____ 18"L
 M15W332221L _____ 21"L
 M15W332224L _____ 24"L

M15W332215- _____ 15"L
 M15W332218- _____ 18"L
 M15W332221- _____ 21"L
 M15W332224- _____ 24"L

Drawer/Cupboard Cabinets

Drawer/Cupboard Cabinets with Pullboards

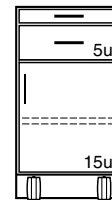
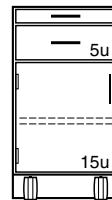
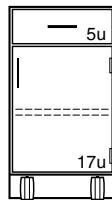
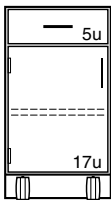

M20W332215L _____ 15"L
 M20W332218L _____ 18"L
 M20W332221L _____ 21"L
 M20W332224L _____ 24"L

M20W332215- _____ 15"L
 M20W332218- _____ 18"L
 M20W332221- _____ 21"L
 M20W332224- _____ 24"L

M25W332215L _____ 15"L
 M25W332218L _____ 18"L
 M25W332221L _____ 21"L
 M25W332224L _____ 24"L

M25W332215- _____ 15"L
 M25W332218- _____ 18"L
 M25W332221- _____ 21"L
 M25W332224- _____ 24"L

Drawer Cabinets

Drawer Cabinets with Pullboards

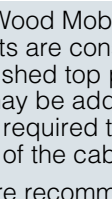
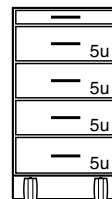
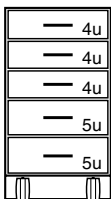

M50W332215- _____ 15"L
 M50W332218- _____ 18"L
 M50W332221- _____ 21"L
 M50W332224- _____ 24"L

M45W332215- _____ 15"L
 M45W332218- _____ 18"L
 M45W332221- _____ 21"L
 M45W332224- _____ 24"L

Note: Wood Mobile Cabinets are constructed with finished top panels. Tops may be added but are not required to close the top of the cabinet.

Tops are recommended on wood mobile cabinets with pullboards.

Tops must be ordered separately. (see page 133)

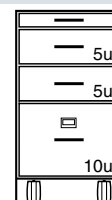
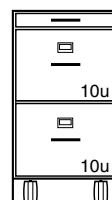
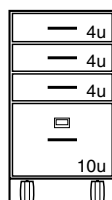
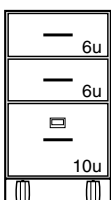

M62W332215- _____ 15"L
 M62W332218- _____ 18"L
 M62W332221- _____ 21"L
 M62W332224- _____ 24"L

M63W332215- _____ 15"L
 M63W332218- _____ 18"L
 M63W332221- _____ 21"L
 M63W332224- _____ 24"L

M75W332215- _____ 15"L
 M75W332218- _____ 18"L
 M75W332221- _____ 21"L
 M75W332224- _____ 24"L

M67W332215- _____ 15"L
 M67W332218- _____ 18"L
 M67W332221- _____ 21"L
 M67W332224- _____ 24"L

Steel Sitting Height Mobile Cabinets

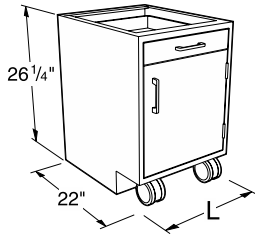

Specifications

Steel Sitting Height Mobile Cabinets are 26 1/4" high and 22" deep. Lengths as shown. Designed to fit under 30" high workstation frames.

Drawer cabinets are furnished with counter weights, multiple-drawer cabinets include an interlock system. All mobile cabinets have finished backs.

Note: Last four digits of part number designates door and drawer head style, hinge, hardwood species and pull selection. See page 98 for full explanation. Actual product may vary slightly from catalog illustration due to style and hardware selection.

Cupboard Cabinets

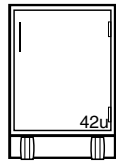
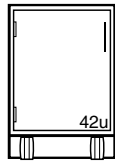

M10C262215L	15"L	M10C262215-	15"L
M10C262218L	18"L	M10C262218-	18"L
M10C262221L	21"L	M10C262221-	21"L
M10C262224L	24"L	M10C262224-	24"L

Note: Steel Mobile Cabinets are constructed with open top frames. Tops are required to close the top of the cabinets.

Tops must be ordered separately.
(see page 132 & 133)

Drawer/Cupboard Cabinets

Drawer/Cupboard Cabinets with Pullboards

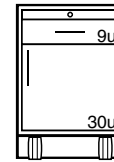
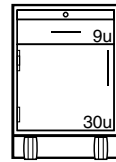
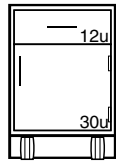
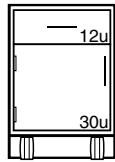

M20C262215L	15"L	M20C262215-	15"L
M20C262218L	18"L	M20C262218-	18"L
M20C262221L	21"L	M20C262221-	21"L
M20C262224L	24"L	M20C262224-	24"L

M25C262215L	15"L	M25C262215-	15"L
M25C262218L	18"L	M25C262218-	18"L
M25C262221L	21"L	M25C262221-	21"L
M25C262224L	24"L	M25C262224-	24"L

Drawer Cabinets

Drawer Cabinets with Pullboards

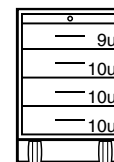
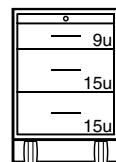
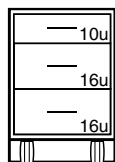

M30C262215-	15"L
M30C262218-	18"L
M30C262221-	21"L
M30C262224-	24"L

M35C262215-	15"L
M35C262218-	18"L
M35C262221-	21"L
M35C262224-	24"L

M45C262215-	15"L
M45C262218-	18"L
M45C262221-	21"L
M45C262224-	24"L

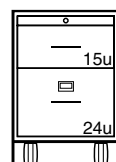
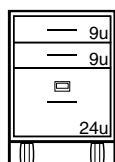

M62C262215-	15"L
M62C262218-	18"L
M62C262221-	21"L
M62C262224-	24"L

M66C262215-	15"L
M66C262218-	18"L
M66C262221-	21"L
M66C262224-	24"L

Steel Standing Height Mobile Cabinets

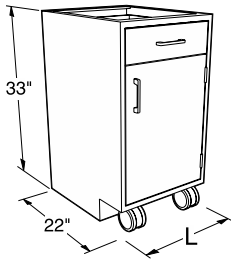

Specifications

Steel Standing Height Mobile Cabinets are 33" high and 22" deep. Lengths as shown. Designed to fit under 36" high workstation frames.

Drawer cabinets are furnished with counter weights, multiple-drawer cabinets include an interlock system. All mobile cabinets have finished backs.

Note: Last four digits of part number designates door and drawer head style, hinge, hardwood species and pull selection. See page 98 for full explanation. Actual product may vary slightly from catalog illustration due to style and hardware selection.

Cupboard Cabinets

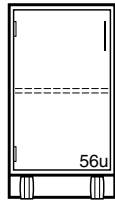

- M10C332215L _____ 15"L
- M10C332218L _____ 18"L
- M10C332221L _____ 21"L
- M10C332224L _____ 24"L

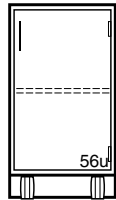

- M10C332215- _____ 15"L
- M10C332218- _____ 18"L
- M10C332221- _____ 21"L
- M10C332224- _____ 24"L

Note: Steel Mobile Cabinets are constructed with open top frames. Tops are required to close the top of the cabinets.

Tops must be ordered separately.
(see page 132 & 133)

Drawer/Cupboard Cabinets

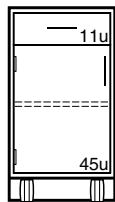

- M20C332215L _____ 15"L
- M20C332218L _____ 18"L
- M20C332221L _____ 21"L
- M20C332224L _____ 24"L

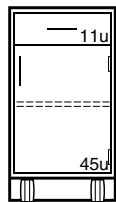

- M20C332215- _____ 15"L
- M20C332218- _____ 18"L
- M20C332221- _____ 21"L
- M20C332224- _____ 24"L

Drawer/Cupboard Cabinets with Pullboards

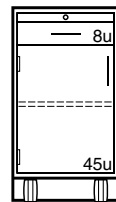

- M25C332215L _____ 15"L
- M25C332218L _____ 18"L
- M25C332221L _____ 21"L
- M25C332224L _____ 24"L



- M25C332215- _____ 15"L
- M25C332218- _____ 18"L
- M25C332221- _____ 21"L
- M25C332224- _____ 24"L

Drawer Cabinets

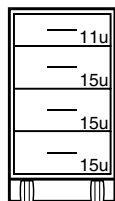

- M40C332215- _____ 15"L
- M40C332218- _____ 18"L
- M40C332221- _____ 21"L
- M40C332224- _____ 24"L

Drawer Cabinets with Pullboards

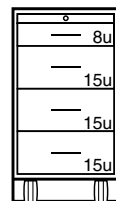

- M46C332215- _____ 15"L
- M46C332218- _____ 18"L
- M46C332221- _____ 21"L
- M46C332224- _____ 24"L

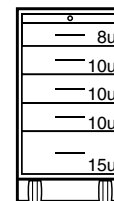

- M56C332215- _____ 15"L
- M56C332218- _____ 18"L
- M56C332221- _____ 21"L
- M56C332224- _____ 24"L

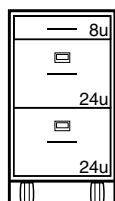

- M71C332215- _____ 15"L
- M71C332218- _____ 18"L
- M71C332221- _____ 21"L
- M71C332224- _____ 24"L

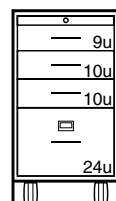

- M68C332215- _____ 15"L
- M68C332218- _____ 18"L
- M68C332221- _____ 21"L
- M68C332224- _____ 24"L

Mobile Cabinet Tops & Accessories

Specifications:

1" Thick Mobile Cabinet Tops are available in three depths, 22", 23", or 24" and three materials: Kemresin, Phenolic Resin or Plastic Laminate. They may be used on any Mobile

Cabinet and add 1" to the overall height of the cabinets. All edges of top are finished.

1" Thick — Mobile Cabinet Top (adds 1" to height of Mobile Cabinet)

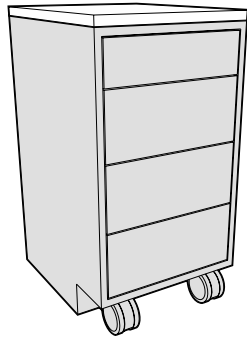

22" Deep flush to front of case

Length	Kemresin®	Kemresin Colors	Black Phenolic Resin	Black Plastic Laminate
15"	F94R2215-00-__	BK = Black	F94T2215-00	F94P2215-00
18"	F94R2218-00-__	GR = Grey	F94T2218-00	F94P2218-00
21"	F94R2221-00-__	PT = Putty	F94T2221-00	F94P2221-00
24"	F94R2224-00-__	SL = Slate	F94T2224-00	F94P2224-00
30"	F94R2230-00-__		F94T2230-00	F94P2230-00
36"	F94R2236-00-__		F94T2236-00	F94P2236-00
42"	F94R2242-00-__		F94T2242-00	F94P2242-00
48"	F94R2248-00-__		F94T2248-00	F94P2248-00

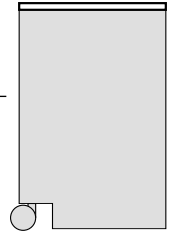

Inset Cabinet End View

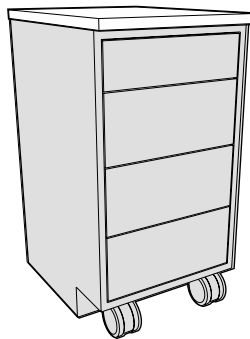

23" Deep flush to overlay door/drawer fronts - 1" overhang of case

Length	Kemresin®	Kemresin Colors	Black Phenolic Resin	Black Plastic Laminate
15"	F94R2315-00-__	BK = Black	F94T2315-00	F94P2315-00
18"	F94R2318-00-__	GR = Grey	F94T2318-00	F94P2318-00
21"	F94R2321-00-__	PT = Putty	F94T2321-00	F94P2321-00
24"	F94R2324-00-__	SL = Slate	F94T2324-00	F94P2324-00
30"	F94R2330-00-__		F94T2330-00	F94P2330-00
36"	F94R2336-00-__		F94T2336-00	F94P2336-00
42"	F94R2342-00-__		F94T2342-00	F94P2342-00
48"	F94R2348-00-__		F94T2348-00	F94P2348-00

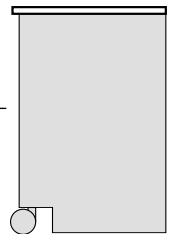

Inset Cabinet End View

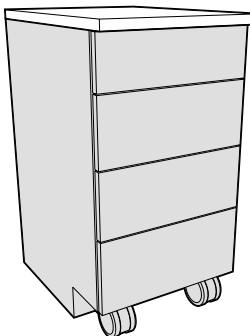

24" Deep 1" overhang of overlay door/drawer fronts

Length	Kemresin®	Kemresin Colors	Black Phenolic Resin	Black Plastic Laminate
15"	F94R2415-00-__	BK = Black	F94T2415-00	F94P2415-00
18"	F94R2418-00-__	GR = Grey	F94T2418-00	F94P2418-00
21"	F94R2421-00-__	PT = Putty	F94T2421-00	F94P2421-00
24"	F94R2424-00-__	SL = Slate	F94T2424-00	F94P2424-00
30"	F94R2430-00-__		F94T2430-00	F94P2430-00
36"	F94R2436-00-__		F94T2436-00	F94P2436-00
42"	F94R2442-00-__		F94T2442-00	F94P2442-00
48"	F94R2448-00-__		F94T2448-00	F94P2448-00

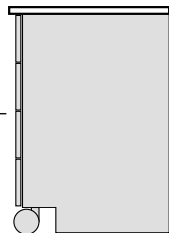

Overlay Cabinet End View

Mobile Cabinet Tops & Accessories

Specifications:

Steel Mobile Cabinet Tops are fabricated from 18 gauge steel and finished to match the cabinet. They are designed for Steel Mobile Cabinets only.

Mobile Cabinet Grabbar allows easier movement and relocation of mobile cabinets. Fabricated from powder coated steel or stainless steel, they may be used on any

Mobile Cabinet, with or without Tops. Bars must be attached in field with supplied screws and/or bolts.

22" Deep — Steel — Mobile Cabinet Top (adds less than 1/4" to height of Mobile Cabinet)

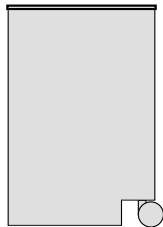
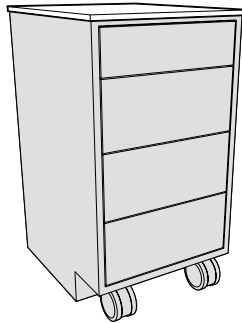

*Inset Cabinet
End View*

22" Deep Top
for Steel Mobile Cabinets only

Lg	Painted Steel	Stainless Steel
15"	F94M2215-00	F94S2215-00
18"	F94M2218-00	F94S2218-00
21"	F94M2221-00	F94S2221-00
24"	F94M2224-00	F94S2224-00
30"	F94M2230-00	F94S2230-00
36"	F94M2236-00	F94S2236-00
42"	F94M2242-00	F94S2242-00
48"	F94M2248-00	F94S2248-00

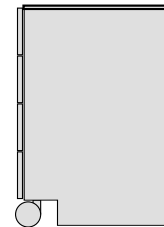

*Overlay Cabinet
End View*

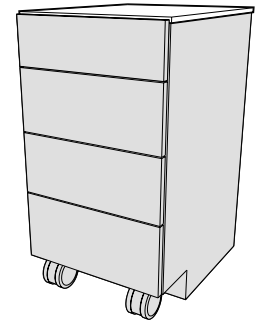

23" Deep — Steel — Mobile Cabinet Top (adds 1/2" to height of Mobile Cabinet)

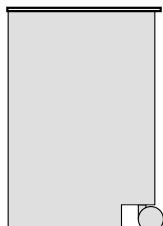
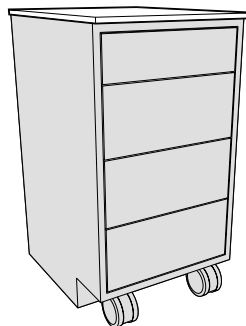

*Inset Cabinet
End View*

23" Deep Top
for Steel Mobile Cabinets only

Lg	Painted Steel	Stainless Steel
15"	F94M2315-00	F94S2315-00
18"	F94M2318-00	F94S2318-00
21"	F94M2321-00	F94S2321-00
24"	F94M2324-00	F94S2324-00
30"	F94M2330-00	F94S2330-00
36"	F94M2336-00	F94S2336-00
42"	F94M2342-00	F94S2342-00
48"	F94M2348-00	F94S2348-00

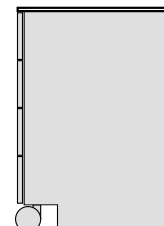

*Overlay Cabinet
End View*

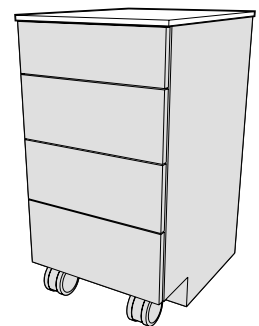

Mobile Cabinet Grabbar

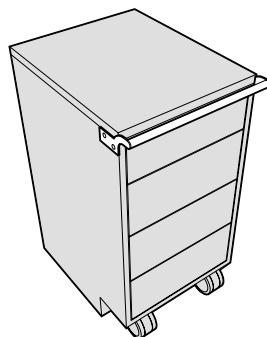

Length	Painted Steel	Stainless Steel
15"	F73M0015-00	F73S0015-00
18"	F73M0018-00	F73S0018-00
21"	F73M0021-00	F73S0021-00
24"	F73M0024-00	F73S0024-00

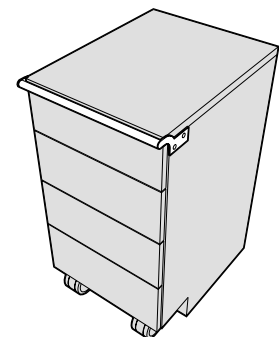

Upper & Full Height Storage Cabinets

Features:

- Both Steel and Wood Upper Cabinets are available.
- Upper Cabinets are available 24" and 30" high, and 12³/₄" and 16" deep.
- Same Upper Cabinet may be mounted on wall or on Alpha System.
- Upper Cabinets may span two Structural Modules.
- Multiple Upper Cabinets may be mounted on a single Structural Module.
- Both Steel and Wood Full Height Storage Cabinets are available.
- Full Height Storage Cabinets match height of Upper Carrier Structural Modules.
- Full Height Storage Cabinets available 12³/₄", 16" or 22" deep.

For a complete list of cabinet options and offering, see the **Kewaunee Research Collection Steel Furniture** and the **Signature Series Wood Furniture** catalogs.

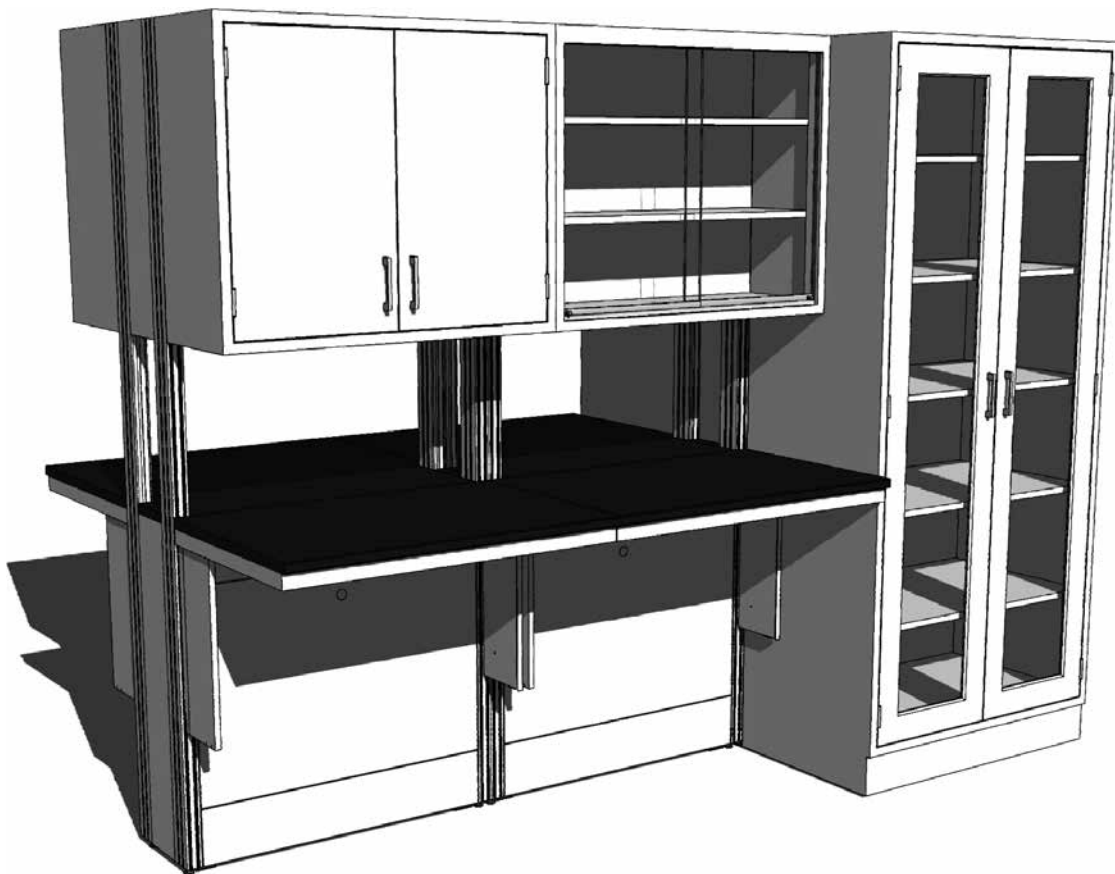

Upper Cabinets – 24" High

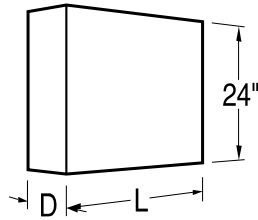

Specifications:

These Upper Cabinets are 24" high and available in two depths. Lengths as shown. They are provided with one adjustable shelf, and are available in either wood or steel.

Hanging system must be ordered separately.

Sliding Plate Glass doors are mounted on friction-free roller glides located at the bottom of the door.

See page 98 and 99 for designating cabinet material on wood wall cabinets.

Open Storage Cabinets

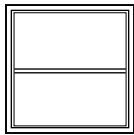

Depth	Steel Cabinet	Length	Wood Cabinet	Depth
12 ³ / ₄ "	W00C241315-00_0	15"	W00W241215-00_0	12 ³ / ₄ "
12 ³ / ₄ "	W00C241318-00_0	18"	W00W241218-00_0	12 ³ / ₄ "
12 ³ / ₄ "	W00C241321-00_0	21"	W00W241221-00_0	12 ³ / ₄ "
12 ³ / ₄ "	W00C241324-00_0	24"	W00W241224-00_0	12 ³ / ₄ "
16"	W00C241615-00_0	15"	W00W241615-00_0	16 ³ / ₄ "
16"	W00C241618-00_0	18"	W00W241618-00_0	16 ³ / ₄ "
16"	W00C241621-00_0	21"	W00W241621-00_0	16 ³ / ₄ "
16"	W00C241624-00_0	24"	W00W241624-00_0	16 ³ / ₄ "

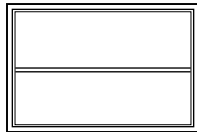
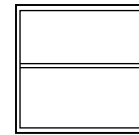

Depth	Steel Cabinet	Length	Wood Cabinet	Depth
12 ³ / ₄ "	W00C241330-00_0	30"	W00W241230-00_0	12 ³ / ₄ "
12 ³ / ₄ "	W00C241336-00_0	36"	W00W241236-00_0	12 ³ / ₄ "
12 ³ / ₄ "	W00C241342-00_0	42"	W00W241242-00_0	12 ³ / ₄ "
12 ³ / ₄ "	W00C241348-00_0	48"	W00W241248-00_0	12 ³ / ₄ "
16"	W00C241630-00_0	30"	W00W241630-00_0	16 ³ / ₄ "
16"	W00C241636-00_0	36"	W00W241636-00_0	16 ³ / ₄ "
16"	W00C241642-00_0	42"	W00W241642-00_0	16 ³ / ₄ "
16"	W00C241648-00_0	48"	W00W241648-00_0	16 ³ / ₄ "

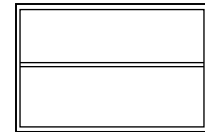

Sliding Plate Glass Door Cabinets

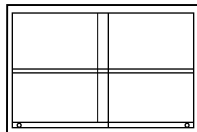

Depth	Steel Cabinet	Length	Wood Cabinet	Depth
12 ³ / ₄ "	W10C241330-00_0	30"	W10W241230-00_0	12 ³ / ₄ "
12 ³ / ₄ "	W10C241336-00_0	36"	W10W241236-00_0	12 ³ / ₄ "
12 ³ / ₄ "	W10C241342-00_0	42"	W10W241242-00_0	12 ³ / ₄ "
12 ³ / ₄ "	W10C241348-00_0	48"	W10W241248-00_0	12 ³ / ₄ "
16"	W10C241630-00_0	30"	W10W241630-00_0	16 ³ / ₄ "
16"	W10C241636-00_0	36"	W10W241636-00_0	16 ³ / ₄ "
16"	W10C241642-00_0	42"	W10W241642-00_0	16 ³ / ₄ "
16"	W10C241648-00_0	48"	W10W241648-00_0	16 ³ / ₄ "

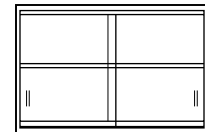

Upper Cabinets – 24" High

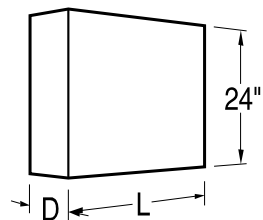

Specifications:

These Upper Cabinets are 24" high and available in two depths. Lengths as shown. They are provided with one adjustable shelf, and are available in either wood or steel.

Sliding Glazed and Panel Doors are suspended by roller from a track at the top of the cabinet.

See page 98 and 99 for designating cabinet door style, door and cabinet material, and pull and hinge selection.

Hanging system must be ordered separately.

Sliding Glazed Door Cabinets

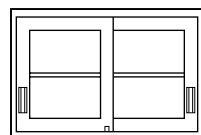

Depth	Steel Cabinet	Length	Wood Cabinet	Depth
12 ³ / ₄ "	W41C241330-__0	15"	W11W241230-__0_0	12 ³ / ₄ "
12 ³ / ₄ "	W41C241336-__0	18"	W11W241236-__0_0	12 ³ / ₄ "
12 ³ / ₄ "	W41C241342-__0	21"	W11W241242-__0_0	12 ³ / ₄ "
12 ³ / ₄ "	W41C241348-__0	24"	W11W241248-__0_0	12 ³ / ₄ "
16"	W41C241630-__0	15"	W11W241630-__0_0	16 ³ / ₄ "
16"	W41C241636-__0	18"	W11W241636-__0_0	16 ³ / ₄ "
16"	W41C241642-__0	21"	W11W241642-__0_0	16 ³ / ₄ "
16"	W41C241648-__0	24"	W11W241648-__0_0	16 ³ / ₄ "

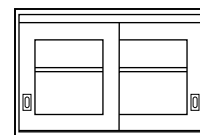

Sliding Panel Door Cabinets

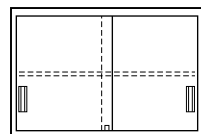

Depth	Steel Cabinet	Length	Wood Cabinet	Depth
12 ³ / ₄ "	W12C241330-__0	15"	W12W241230-__0_0	12 ³ / ₄ "
12 ³ / ₄ "	W12C241336-__0	18"	W12W241236-__0_0	12 ³ / ₄ "
12 ³ / ₄ "	W12C241342-__0	21"	W12W241242-__0_0	12 ³ / ₄ "
12 ³ / ₄ "	W12C241348-__0	24"	W12W241248-__0_0	12 ³ / ₄ "
16"	W12C241630-__0	15"	W12W241630-__0_0	16 ³ / ₄ "
16"	W12C241636-__0	18"	W12W241636-__0_0	16 ³ / ₄ "
16"	W12C241642-__0	21"	W12W241642-__0_0	16 ³ / ₄ "
16"	W12C241648-__0	24"	W12W241648-__0_0	16 ³ / ₄ "

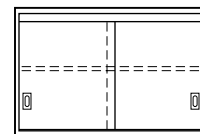

Swinging Glazed Door Cabinets

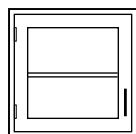

Depth	Steel Cabinet	Length	Wood Cabinet	Depth
12 ³ / ₄ "	W50C241315L	15"	W20W241215L	12 ³ / ₄ "
12 ³ / ₄ "	W50C241318L	18"	W20W241218L	12 ³ / ₄ "
12 ³ / ₄ "	W50C241321L	21"	W20W241221L	12 ³ / ₄ "
12 ³ / ₄ "	W50C241324L	24"	W20W241224L	12 ³ / ₄ "
16"	W50C241615L	15"	W20W241615L	16 ³ / ₄ "
16"	W50C241618L	18"	W20W241618L	16 ³ / ₄ "
16"	W50C241621L	21"	W20W241621L	16 ³ / ₄ "
16"	W50C241624L	24"	W20W241624L	16 ³ / ₄ "

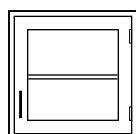
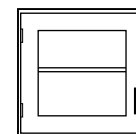

Depth	Steel Cabinet	Length	Wood Cabinet	Depth
12 ³ / ₄ "	W50C241315-	15"	W20W241215-	12 ³ / ₄ "
12 ³ / ₄ "	W50C241318-	18"	W20W241218-	12 ³ / ₄ "
12 ³ / ₄ "	W50C241321-	21"	W20W241221-	12 ³ / ₄ "
12 ³ / ₄ "	W50C241324-	24"	W20W241224-	12 ³ / ₄ "
16"	W50C241615-	15"	W20W241615-	16 ³ / ₄ "
16"	W50C241618-	18"	W20W241618-	16 ³ / ₄ "
16"	W50C241621-	21"	W20W241621-	16 ³ / ₄ "
16"	W50C241624-	24"	W20W241624-	16 ³ / ₄ "

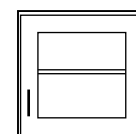

Upper Cabinets – 24" High

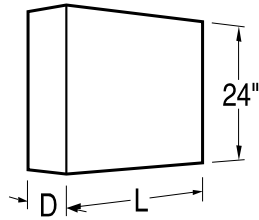

Specifications:

These Upper Cabinets are 24" high and available in two depths. Lengths as shown. They are provided with one adjustable shelf, and are available in either wood or steel.

See page 98 and 99 for designating cabinet door style, door and cabinet material, and pull and hinge selection.

Hanging system must be ordered separately.

Swinging Glazed Door Cabinets

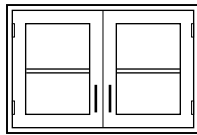

Depth	Steel Cabinet	Length	Wood Cabinet	Depth
12 ³ / ₄ "	W50C241330-	30"	W20W241230-	12 ³ / ₄ "
12 ³ / ₄ "	W50C241336-	36"	W20W241236-	12 ³ / ₄ "
12 ³ / ₄ "	W50C241342-	42"	W20W241242-	12 ³ / ₄ "
12 ³ / ₄ "	W50C241348-	48"	W20W241248-	12 ³ / ₄ "
16"	W50C241630-	30"	W20W241630-	16 ³ / ₄ "
16"	W50C241636-	36"	W20W241636-	16 ³ / ₄ "
16"	W50C241642-	42"	W20W241642-	16 ³ / ₄ "
16"	W50C241648-	48"	W20W241648-	16 ³ / ₄ "

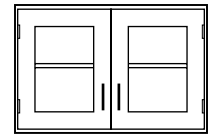

Swinging Panel Door Cabinets

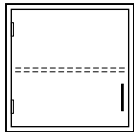

Depth	Steel Cabinet	Length	Wood Cabinet	Depth
12 ³ / ₄ "	W25C241315L	15"	W25W241215L	12 ³ / ₄ "
12 ³ / ₄ "	W25C241318L	18"	W25W241218L	12 ³ / ₄ "
12 ³ / ₄ "	W25C241321L	21"	W25W241221L	12 ³ / ₄ "
12 ³ / ₄ "	W25C241324L	24"	W25W241224L	12 ³ / ₄ "
16"	W25C241615L	15"	W25W241615L	16 ³ / ₄ "
16"	W25C241618L	18"	W25W241618L	16 ³ / ₄ "
16"	W25C241621L	21"	W25W241621L	16 ³ / ₄ "
16"	W25C241624L	24"	W25W241624L	16 ³ / ₄ "

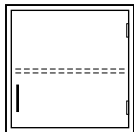
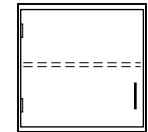

Depth	Steel Cabinet	Length	Wood Cabinet	Depth
12 ³ / ₄ "	W25C241315-	15"	W25W241215-	12 ³ / ₄ "
12 ³ / ₄ "	W25C241318-	18"	W25W241218-	12 ³ / ₄ "
12 ³ / ₄ "	W25C241321-	21"	W25W241221-	12 ³ / ₄ "
12 ³ / ₄ "	W25C241324-	24"	W25W241224-	12 ³ / ₄ "
16"	W25C241615-	15"	W25W241615-	16 ³ / ₄ "
16"	W25C241618-	18"	W25W241618-	16 ³ / ₄ "
16"	W25C241621-	21"	W25W241621-	16 ³ / ₄ "
16"	W25C241624-	24"	W25W241624-	16 ³ / ₄ "

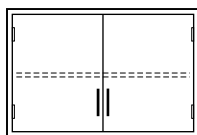
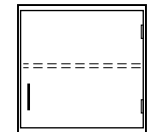

Depth	Steel Cabinet	Length	Wood Cabinet	Depth
12 ³ / ₄ "	W25C241330-	30"	W25W241230-	12 ³ / ₄ "
12 ³ / ₄ "	W25C241336-	36"	W25W241236-	12 ³ / ₄ "
12 ³ / ₄ "	W25C241342-	42"	W25W241242-	12 ³ / ₄ "
12 ³ / ₄ "	W25C241348-	48"	W25W241248-	12 ³ / ₄ "
16"	W25C241630-	30"	W25W241630-	16 ³ / ₄ "
16"	W25C241636-	36"	W25W241636-	16 ³ / ₄ "
16"	W25C241642-	42"	W25W241642-	16 ³ / ₄ "
16"	W25C241648-	48"	W25W241648-	16 ³ / ₄ "

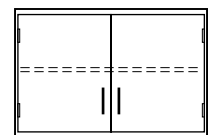

Upper Cabinets – 30" High

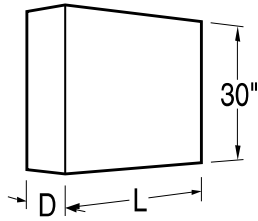

Specifications:

These Upper Cabinets are 30" high and available in two depths. Lengths as shown. They are provided with two adjustable shelves, and are available in either wood or steel.

Sliding Plate Glass doors are mounted on friction-free roller glides located at the bottom of the door.

See page 98 and 99 for designating cabinet material on wood wall cabinets.

Hanging system must be ordered separately.

Open Storage Cabinets

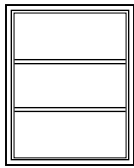

Depth	Steel Cabinet	Length	Wood Cabinet	Depth
12 ³ / ₄ "	W00C301315-00_0	15"	W00W301215-00_0	12 ³ / ₄ "
12 ³ / ₄ "	W00C301318-00_0	18"	W00W301218-00_0	12 ³ / ₄ "
12 ³ / ₄ "	W00C301321-00_0	21"	W00W301221-00_0	12 ³ / ₄ "
12 ³ / ₄ "	W00C301324-00_0	24"	W00W301224-00_0	12 ³ / ₄ "
16"	W00C301615-00_0	15"	W00W301615-00_0	16 ³ / ₄ "
16"	W00C301618-00_0	18"	W00W301618-00_0	16 ³ / ₄ "
16"	W00C301621-00_0	21"	W00W301621-00_0	16 ³ / ₄ "
16"	W00C301624-00_0	24"	W00W301624-00_0	16 ³ / ₄ "

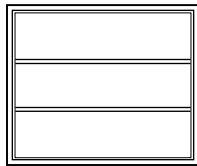
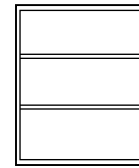

Depth	Steel Cabinet	Length	Wood Cabinet	Depth
12 ³ / ₄ "	W00C301330-00_0	30"	W00W301230-00_0	12 ³ / ₄ "
12 ³ / ₄ "	W00C301336-00_0	36"	W00W301236-00_0	12 ³ / ₄ "
12 ³ / ₄ "	W00C301342-00_0	42"	W00W301242-00_0	12 ³ / ₄ "
12 ³ / ₄ "	W00C301348-00_0	48"	W00W301248-00_0	12 ³ / ₄ "
16"	W00C301630-00_0	30"	W00W301630-00_0	16 ³ / ₄ "
16"	W00C301636-00_0	36"	W00W301636-00_0	16 ³ / ₄ "
16"	W00C301642-00_0	42"	W00W301642-00_0	16 ³ / ₄ "
16"	W00C301648-00_0	48"	W00W301648-00_0	16 ³ / ₄ "



Sliding Plate Glass Door Cabinets

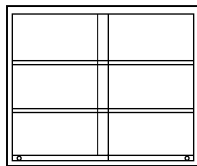

Depth	Steel Cabinet	Length	Wood Cabinet	Depth
12 ³ / ₄ "	W10C301330-00_0	30"	W10W301230-00_0	12 ³ / ₄ "
12 ³ / ₄ "	W10C301336-00_0	36"	W10W301236-00_0	12 ³ / ₄ "
12 ³ / ₄ "	W10C301342-00_0	42"	W10W301242-00_0	12 ³ / ₄ "
12 ³ / ₄ "	W10C301348-00_0	48"	W10W301248-00_0	12 ³ / ₄ "
16"	W10C301630-00_0	30"	W10W301630-00_0	16 ³ / ₄ "
16"	W10C301636-00_0	36"	W10W301636-00_0	16 ³ / ₄ "
16"	W10C301642-00_0	42"	W10W301642-00_0	16 ³ / ₄ "
16"	W10C301648-00_0	48"	W10W301648-00_0	16 ³ / ₄ "

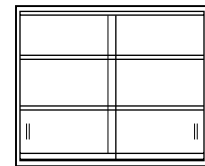

Upper Cabinets – 30" High

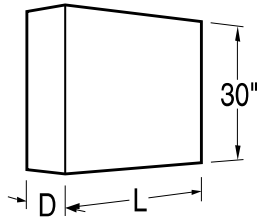

Specifications:

These Upper Cabinets are 30" high and available in two depths. Lengths as shown. They are provided with two adjustable shelves, and are available in either wood or steel.

Sliding Panel Doors are suspended by roller from a track at the top of the cabinet.

See page 98 and 99 for designating cabinet door style, door and cabinet material, and pull and hinge selection.

Hanging system must be ordered separately.

Sliding Glazed Door Cabinets

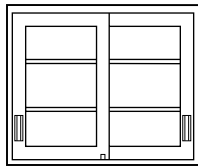

Depth	Steel Cabinet	Length	Wood Cabinet	Depth
12 ³ / ₄ "	W41C301330-__0	15"	W11W301230-_0_0	12 ³ / ₄ "
12 ³ / ₄ "	W41C301336-__0	18"	W11W301236-_0_0	12 ³ / ₄ "
12 ³ / ₄ "	W41C301342-__0	21"	W11W301242-_0_0	12 ³ / ₄ "
12 ³ / ₄ "	W41C301348-__0	24"	W11W301248-_0_0	12 ³ / ₄ "
16"	W41C301630-__0	15"	W11W301630-_0_0	16 ³ / ₄ "
16"	W41C301636-__0	18"	W11W301636-_0_0	16 ³ / ₄ "
16"	W41C301642-__0	21"	W11W301642-_0_0	16 ³ / ₄ "
16"	W41C301648-__0	24"	W11W301648-_0_0	16 ³ / ₄ "

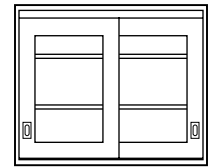

Sliding Panel Door Cabinets

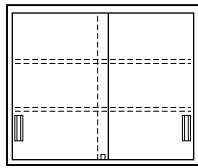

Depth	Steel Cabinet	Length	Wood Cabinet	Depth
12 ³ / ₄ "	W12C301330-__0	15"	W12W301230-_0_0	12 ³ / ₄ "
12 ³ / ₄ "	W12C301336-__0	18"	W12W301236-_0_0	12 ³ / ₄ "
12 ³ / ₄ "	W12C301342-__0	21"	W12W301242-_0_0	12 ³ / ₄ "
12 ³ / ₄ "	W12C301348-__0	24"	W12W301248-_0_0	12 ³ / ₄ "
16"	W12C301630-__0	15"	W12W301630-_0_0	16 ³ / ₄ "
16"	W12C301636-__0	18"	W12W301636-_0_0	16 ³ / ₄ "
16"	W12C301642-__0	21"	W12W301642-_0_0	16 ³ / ₄ "
16"	W12C301648-__0	24"	W12W301648-_0_0	16 ³ / ₄ "

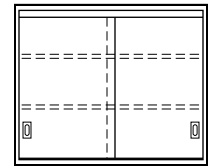

Swinging Glazed Door Cabinets

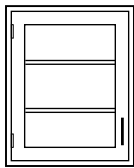

Depth	Steel Cabinet	Length	Wood Cabinet	Depth
12 ³ / ₄ "	W50C301315L	15"	W20W301215L	12 ³ / ₄ "
12 ³ / ₄ "	W50C301318L	18"	W20W301218L	12 ³ / ₄ "
12 ³ / ₄ "	W50C301321L	21"	W20W301221L	12 ³ / ₄ "
12 ³ / ₄ "	W50C301324L	24"	W20W301224L	12 ³ / ₄ "
16"	W50C301615L	15"	W20W301615L	16 ³ / ₄ "
16"	W50C301618L	18"	W20W301618L	16 ³ / ₄ "
16"	W50C301621L	21"	W20W301621L	16 ³ / ₄ "
16"	W50C301624L	24"	W20W301624L	16 ³ / ₄ "

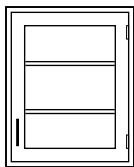
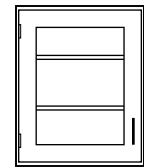

Depth	Steel Cabinet	Length	Wood Cabinet	Depth
12 ³ / ₄ "	W50C301315-	15"	W20W301215-	12 ³ / ₄ "
12 ³ / ₄ "	W50C301318-	18"	W20W301218-	12 ³ / ₄ "
12 ³ / ₄ "	W50C301321-	21"	W20W301221-	12 ³ / ₄ "
12 ³ / ₄ "	W50C301324-	24"	W20W301224-	12 ³ / ₄ "
16"	W50C301615-	15"	W20W301615-	16 ³ / ₄ "
16"	W50C301618-	18"	W20W301618-	16 ³ / ₄ "
16"	W50C301621-	21"	W20W301621-	16 ³ / ₄ "
16"	W50C301624-	24"	W20W301624-	16 ³ / ₄ "

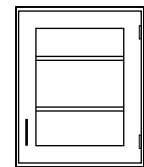

Upper Cabinets – 30" High

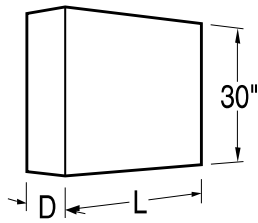

Specifications:

These Upper Cabinets are 30" high and available in two depths. Lengths as shown. They are provided with two adjustable shelves, and are available in either wood or steel.

See page 98 and 99 for designating cabinet door style, door and cabinet material, and pull and hinge selection.

Hanging system must be ordered separately.

Swinging Glazed Door Cabinets

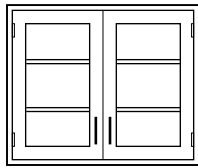

Depth	Steel Cabinet	Length	Wood Cabinet	Depth
12 ³ / ₄ "	W50C301330-	30"	W20W301230-	12 ³ / ₄ "
12 ³ / ₄ "	W50C301336-	36"	W20W301236-	12 ³ / ₄ "
12 ³ / ₄ "	W50C301342-	42"	W20W301242-	12 ³ / ₄ "
12 ³ / ₄ "	W50C301348-	48"	W20W301248-	12 ³ / ₄ "
16"	W50C301630-	30"	W20W301630-	16 ³ / ₄ "
16"	W50C301636-	36"	W20W301636-	16 ³ / ₄ "
16"	W50C301642-	42"	W20W301642-	16 ³ / ₄ "
16"	W50C301648-	48"	W20W301648-	16 ³ / ₄ "

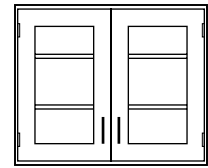

Swinging Panel Door Cabinets

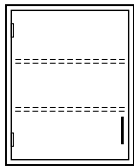

Depth	Steel Cabinet	Length	Wood Cabinet	Depth
12 ³ / ₄ "	W25C301315L	15"	W25W301215L	12 ³ / ₄ "
12 ³ / ₄ "	W25C301318L	18"	W25W301218L	12 ³ / ₄ "
12 ³ / ₄ "	W25C301321L	21"	W25W301221L	12 ³ / ₄ "
12 ³ / ₄ "	W25C301324L	24"	W25W301224L	12 ³ / ₄ "
16"	W25C301615L	15"	W25W301615L	16 ³ / ₄ "
16"	W25C301618L	18"	W25W301618L	16 ³ / ₄ "
16"	W25C301621L	21"	W25W301621L	16 ³ / ₄ "
16"	W25C301624L	24"	W25W301624L	16 ³ / ₄ "

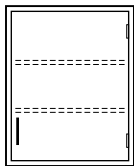
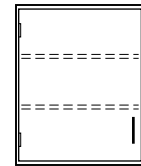

Depth	Steel Cabinet	Length	Wood Cabinet	Depth
12 ³ / ₄ "	W25C301315-	15"	W25W301215-	12 ³ / ₄ "
12 ³ / ₄ "	W25C301318-	18"	W25W301218-	12 ³ / ₄ "
12 ³ / ₄ "	W25C301321-	21"	W25W301221-	12 ³ / ₄ "
12 ³ / ₄ "	W25C301324-	24"	W25W301224-	12 ³ / ₄ "
16"	W25C301615-	15"	W25W301615-	16 ³ / ₄ "
16"	W25C301618-	18"	W25W301618-	16 ³ / ₄ "
16"	W25C301621-	21"	W25W301621-	16 ³ / ₄ "
16"	W25C301624-	24"	W25W301624-	16 ³ / ₄ "

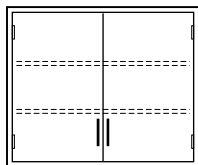
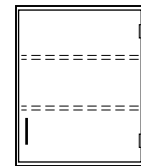

Depth	Steel Cabinet	Length	Wood Cabinet	Depth
12 ³ / ₄ "	W25C301330-	30"	W25W301230-	12 ³ / ₄ "
12 ³ / ₄ "	W25C301336-	36"	W25W301236-	12 ³ / ₄ "
12 ³ / ₄ "	W25C301342-	42"	W25W301242-	12 ³ / ₄ "
12 ³ / ₄ "	W25C301348-	48"	W25W301248-	12 ³ / ₄ "
16"	W25C301630-	30"	W25W301630-	16 ³ / ₄ "
16"	W25C301636-	36"	W25W301636-	16 ³ / ₄ "
16"	W25C301642-	42"	W25W301642-	16 ³ / ₄ "
16"	W25C301648-	48"	W25W301648-	16 ³ / ₄ "

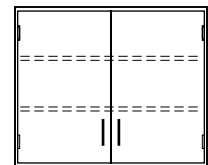

Full Height Storage Cabinets – 84" High

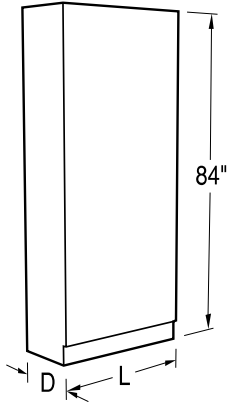

Specifications:

Full Height Storage Cabinets are 84" high and 12", 16" or 22" deep. Lengths as shown.

Full Height Storage Cabinets are manufactured with four full-depth adjustable shelves and one fixed center shelf.

See page 98 and 99 for designating cabinet door style and door and cabinet material.

CAUTION: Full Height cabinets may present a potential tipping over problem. Proper installation requires these cabinets to be anchored to a wall, Structural Module, or other cabinets to improve stability and ensure smooth door movement.

Open Storage Cabinets

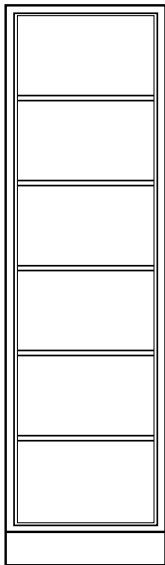

Depth	Steel Cabinet	Length	Wood Cabinet	Depth
12 ³ / ₄ "	S00C841318-00_0	18"	S00W841218-00_0	12"
12 ³ / ₄ "	S00C841324-00_0	24"	S00W841224-00_0	12"
16"	S00C841618-00_0	18"	S00W841618-00_0	16"
16"	S00C841624-00_0	24"	S00W841624-00_0	16"
22"	S00C842218-00_0	18"	S00W842218-00_0	21 ³ / ₄ "
22"	S00C842224-00_0	24"	S00W842224-00_0	21 ³ / ₄ "

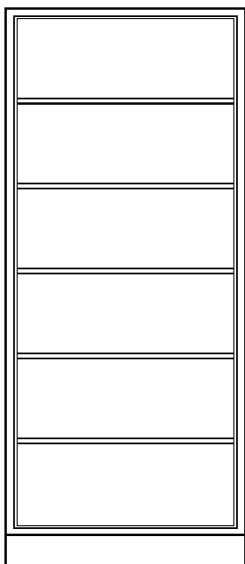
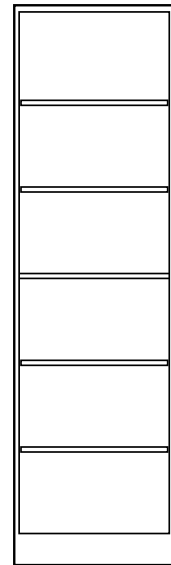

Depth	Steel Cabinet	Length	Wood Cabinet	Depth
12 ³ / ₄ "	S00C841330-00_0	30"	S00W841230-00_0	12"
12 ³ / ₄ "	S00C841336-00_0	36"	S00W841236-00_0	12"
12 ³ / ₄ "	S00C841342-00_0	42"	S00W841242-00_0	12"
12 ³ / ₄ "	S00C841348-00_0	48"	S00W841248-00_0	12"
16"	S00C841630-00_0	30"	S00W841630-00_0	16"
16"	S00C841636-00_0	36"	S00W841636-00_0	16"
16"	S00C841642-00_0	42"	S00W841642-00_0	16"
16"	S00C841648-00_0	48"	S00W841648-00_0	16"
22"	S00C842230-00_0	30"	S00W842230-00_0	21 ³ / ₄ "
22"	S00C842236-00_0	36"	S00W842236-00_0	21 ³ / ₄ "
22"	S00C842242-00_0	24"	S00W842242-00_0	21 ³ / ₄ "
22"	S00C842248-00_0	24"	S00W842248-00_0	21 ³ / ₄ "

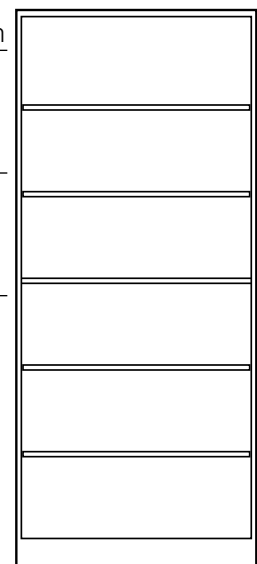

Full Height Storage Cabinets – 84" High

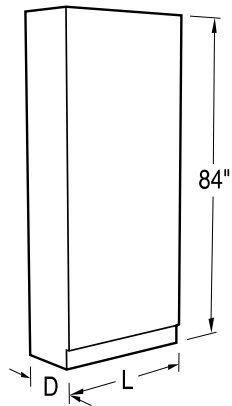

Specifications:

Full Height Storage Cabinets are 84" high and 12", 16" or 22" deep. Lengths as shown.

Full Height Storage Cabinets are manufactured with four full-depth adjustable shelves and one fixed center shelf.

Sliding Glazed and Panel Doors are suspended by rollers from a track at the top of the cabinet.

See page 98 and 99 for designating cabinet door style and door and cabinet material.

CAUTION: Full Height cabinets may present a potential tipping over problem. Proper installation requires these cabinets to be anchored to a wall, Structural Module, or other cabinets to improve stability and ensure smooth door movement.

Glazed Sliding Door Cabinets

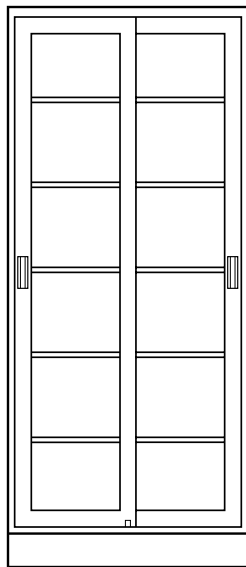

Depth	Steel Cabinet	Length	Wood Cabinet	Depth
12 ³ / ₄ "	S41C841330-___0	30"	S11W841230-00_0	12"
12 ³ / ₄ "	S41C841336-___0	36"	S11W841236-00_0	12"
12 ³ / ₄ "	S41C841342-___0	42"	S11W841242-00_0	12"
12 ³ / ₄ "	S41C841348-___0	48"	S11W841248-00_0	12"
16"	S41C841630-___0	30"	S11W841630-00_0	16"
16"	S41C841636-___0	36"	S11W841636-00_0	16"
16"	S41C841642-___0	42"	S11W841642-00_0	16"
16"	S41C841648-___0	48"	S11W841648-00_0	16"
22"	S41C842230-___0	30"	S11W842230-00_0	21 ³ / ₄ "
22"	S41C842236-___0	36"	S11W842236-00_0	21 ³ / ₄ "
22"	S41C842242-___0	24"	S11W842242-00_0	21 ³ / ₄ "
22"	S41C842248-___0	24"	S11W842248-00_0	21 ³ / ₄ "

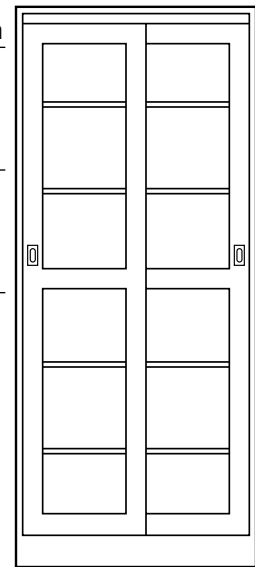

Full Height Storage Cabinets – 84" High

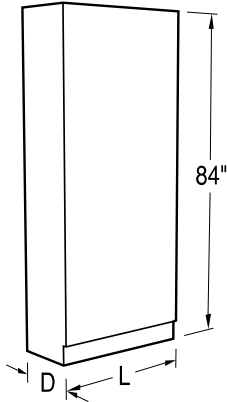

Specifications:

Full Height Storage Cabinets are 84" high and 12", 16" or 22" deep. Lengths as shown.

Full Height Storage Cabinets are manufactured with four full-depth adjustable shelves and one fixed center shelf.

Sliding Glazed and Panel Doors are suspended by rollers from a track at the top of the cabinet.

See page 98 and 99 for designating cabinet door style and door and cabinet material.

CAUTION: Full Height cabinets may present a potential tipping over problem. Proper installation requires these cabinets to be anchored to a wall, Structural Module, or other cabinets to improve stability and ensure smooth door movement.

Paneled Sliding Door Cabinets

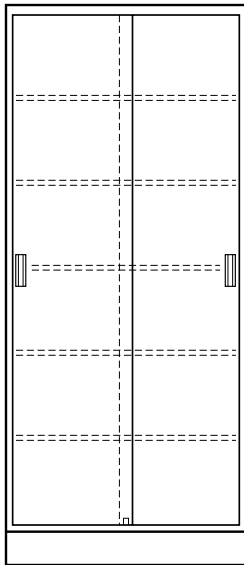

Depth	Steel Cabinet	Length	Wood Cabinet	Depth
12 ³ / ₄ "	S12C841330-__0	30"	S12W841230-00_0	12"
12 ³ / ₄ "	S12C841336-__0	36"	S12W841236-00_0	12"
12 ³ / ₄ "	S12C841342-__0	42"	S12W841242-00_0	12"
12 ³ / ₄ "	S12C841348-__0	48"	S12W841248-00_0	12"
16"	S12C841630-__0	30"	S12W841630-00_0	16"
16"	S12C841636-__0	36"	S12W841636-00_0	16"
16"	S12C841642-__0	42"	S12W841642-00_0	16"
16"	S12C841648-__0	48"	S12W841648-00_0	16"
22"	S12C842230-__0	30"	S12W842230-00_0	21 ³ / ₄ "
22"	S12C842236-__0	36"	S12W842236-00_0	21 ³ / ₄ "
22"	S12C842242-__0	24"	S12W842242-00_0	21 ³ / ₄ "
22"	S12C842248-__0	24"	S12W842248-00_0	21 ³ / ₄ "

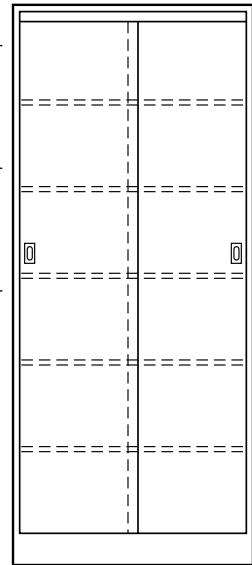

Full Height Storage Cabinets – 84" High

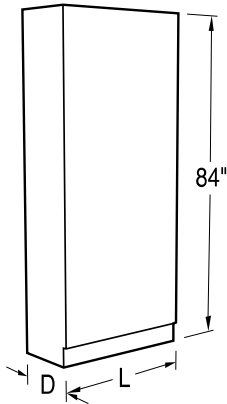

Specifications:

Full Height Storage Cabinets are 84" high and 12", 16" or 22" deep. Lengths as shown.

Full Height Storage Cabinets are manufactured with four full-depth adjustable shelves and one fixed center shelf.

See page 98 and 99 for designating cabinet door style, door and cabinet material, and pull and hinge selection.

CAUTION: Full Height cabinets may present a potential tipping over problem. Proper installation requires these cabinets to be anchored to a wall, Structural Module, or other cabinets to improve stability and ensure smooth door movement.

Glazed Swinging Door Cabinets

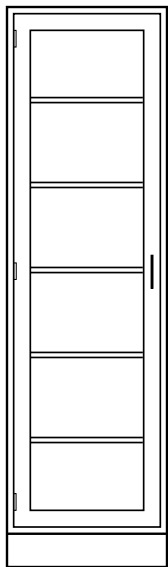

Left-Hand Swing Door

Depth	Steel Cabinet	Length	Wood Cabinet	Depth
12 ³ / ₄ "	S50C841318L	18"	S20W841218L	12 ³ / ₄ "
12 ³ / ₄ "	S50C841324L	24"	S20W841224L	12 ³ / ₄ "
16"	S50C841618L	18"	S20W841618L	16 ³ / ₄ "
16"	S50C841624L	24"	S20W841624L	16 ³ / ₄ "
22"	S50C842218L	18"	S20W842218L	22"
22"	S50C842224L	24"	S20W842224L	22"

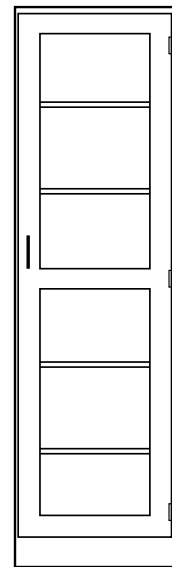

Right-Hand Swing Door

Depth	Steel Cabinet	Length	Wood Cabinet	Depth
12 ³ / ₄ "	S50C841318-	18"	S20W841218-	12 ³ / ₄ "
12 ³ / ₄ "	S50C841324-	24"	S20W841224-	12 ³ / ₄ "
16"	S50C841618-	18"	S20W841618-	16 ³ / ₄ "
16"	S50C841624-	24"	S20W841624-	16 ³ / ₄ "
22"	S50C842218-	18"	S20W842218-	22"
22"	S50C842224-	24"	S20W842224-	22"

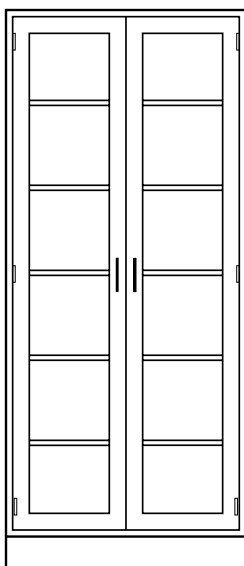

Depth	Steel Cabinet	Length	Wood Cabinet	Depth
12 ³ / ₄ "	S50C841330-	30"	S20W841230-	12 ³ / ₄ "
12 ³ / ₄ "	S50C841336-	36"	S20W841236-	12 ³ / ₄ "
12 ³ / ₄ "	S50C841342-	42"	S20W841242-	12 ³ / ₄ "
12 ³ / ₄ "	S50C841348-	48"	S20W841248-	12 ³ / ₄ "
16"	S50C841630-	30"	S20W841630-	16 ³ / ₄ "
16"	S50C841636-	36"	S20W841636-	16 ³ / ₄ "
16"	S50C841642-	42"	S20W841642-	16 ³ / ₄ "
16"	S50C841648-	48"	S20W841648-	16 ³ / ₄ "
22"	S50C842230-	30"	S20W842230-	21 ³ / ₄ "
22"	S50C842236-	36"	S20W842236-	21 ³ / ₄ "
22"	S50C842242-	24"	S20W842242-	21 ³ / ₄ "
22"	S50C842248-	24"	S20W842248-	21 ³ / ₄ "

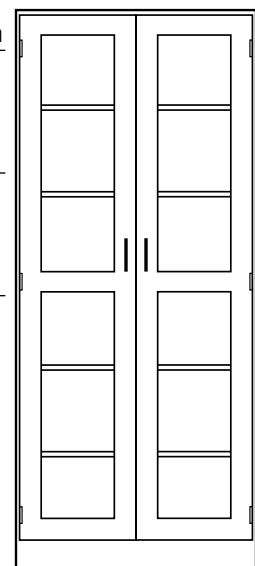

Full Height Storage Cabinets – 84" High

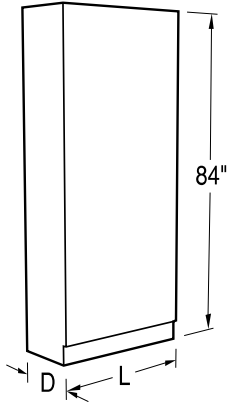

Specifications:

Full Height Storage Cabinets are 84" high and 12", 16" or 22" deep. Lengths as shown.

Full Height Storage Cabinets are manufactured with four full-depth adjustable shelves and one fixed center shelf.

See page 98 and 99 for designating cabinet door style, door and cabinet material, and pull and hinge selection.

CAUTION: Full Height cabinets may present a potential tipping over problem. Proper installation requires these cabinets to be anchored to a wall, Structural Module, or other cabinets to improve stability and ensure smooth door movement.

Paneled Swinging Door Cabinets

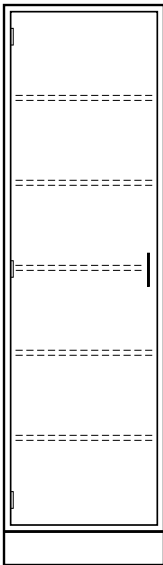

Left-Hand Swing Door

Depth	Steel Cabinet	Length	Wood Cabinet	Depth
12 ³ / ₄ "	S25C841318L	18"	S25W841218L	12 ³ / ₄ "
12 ³ / ₄ "	S25C841324L	24"	S25W841224L	12 ³ / ₄ "
16"	S25C841618L	18"	S25W841618L	16 ³ / ₄ "
16"	S25C841624L	24"	S25W841624L	16 ³ / ₄ "
22"	S25C842218L	18"	S25W842218L	22"
22"	S25C842224L	24"	S25W842224L	22"

Right-Hand Swing Door

Depth	Steel Cabinet	Length	Wood Cabinet	Depth
12 ³ / ₄ "	S25C841318-	18"	S25W841218-	12 ³ / ₄ "
12 ³ / ₄ "	S25C841324-	24"	S25W841224-	12 ³ / ₄ "
16"	S25C841618-	18"	S25W841618-	16 ³ / ₄ "
16"	S25C841624-	24"	S25W841624-	16 ³ / ₄ "
22"	S25C842218-	18"	S25W842218-	22"
22"	S25C842224-	24"	S25W842224-	22"

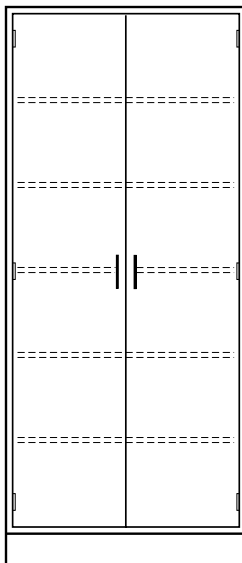
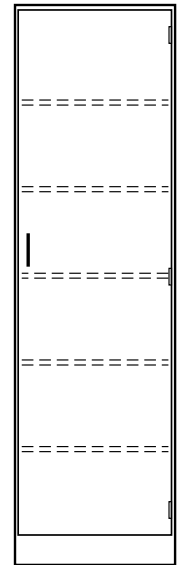

Depth	Steel Cabinet	Length	Wood Cabinet	Depth
12 ³ / ₄ "	S25C841330-	30"	S25W841230-	12 ³ / ₄ "
12 ³ / ₄ "	S25C841336-	36"	S25W841236-	12 ³ / ₄ "
12 ³ / ₄ "	S25C841342-	42"	S25W841242-	12 ³ / ₄ "
12 ³ / ₄ "	S25C841348-	48"	S25W841248-	12 ³ / ₄ "
16"	S25C841630-	30"	S25W841630-	16 ³ / ₄ "
16"	S25C841636-	36"	S25W841636-	16 ³ / ₄ "
16"	S25C841642-	42"	S25W841642-	16 ³ / ₄ "
16"	S25C841648-	48"	S25W841648-	16 ³ / ₄ "
22"	S25C842230-	30"	S25W842230-	21 ³ / ₄ "
22"	S25C842236-	36"	S25W842236-	21 ³ / ₄ "
22"	S25C842242-	24"	S25W842242-	21 ³ / ₄ "
22"	S25C842248-	24"	S25W842248-	21 ³ / ₄ "

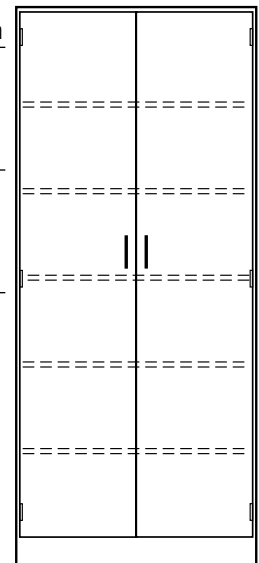

Laboratory Pegboards

Kemresin Laboratory Pegboards

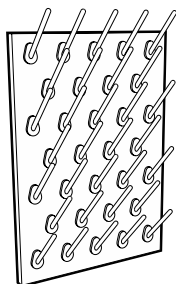

Pegboard without Drip Trough
29" High x 1" Thick x 20" Long

	Pegboard Color	Peg Color
X-020014-BK	Black	Black
X-020014-GR	Grey	White
X-020014-PT	Putty	White
X-020014-SL	Slate	White

Peg Size: 1/2" dia. x 6 1/8" long
Peg Material: Polypropylene
Number of Pegs: 32

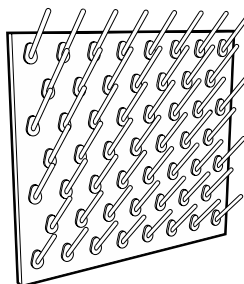

Pegboard without Drip Trough
29" High x 1" Thick x 32" Long

	Pegboard Color	Peg Color
X-020015-BK	Black	Black
X-020015-GR	Grey	White
X-020015-PT	Putty	White
X-020015-SL	Slate	White

Peg Size: 1/2" dia. x 6 1/8" long
Peg Material: Polypropylene
Number of Pegs: 53

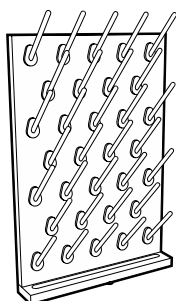

Pegboard with Drip Trough
30" High x 1" Thick x 20" Long

	Pegboard Color	Peg Color
X-020016-BK	Black	Black
X-020016-GR	Grey	White
X-020016-PT	Putty	White
X-020016-SL	Slate	White

Peg Size: 1/2" dia. x 6 1/8" long
Peg Material: Polypropylene
Number of Pegs: 32
Trough Size: 1" high x 2 1/4" deep

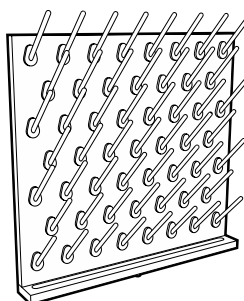

Pegboard with Drip Trough
30" High x 1" Thick x 32" Long

	Pegboard Color	Peg Color
X-020017-BK	Black	Black
X-020017-GR	Grey	White
X-020017-PT	Putty	White
X-020017-SL	Slate	White

Peg Size: 1/2" dia. x 6 1/8" long
Peg Material: Polypropylene
Number of Pegs: 53
Trough Size: 1" high x 2 1/4" deep



Stainless Steel Drip Trough

F-2939-00 for use on X-020014 Pegboard

Size: 1 1/2"H x 2 1/2"W x 20"L
Material: Type 304 Stainless Steel
Includes: 1/2" OD drain outlet



Stainless Steel Drip Trough

F-2940-00 for use on X-020015 Pegboard

Size: 1 1/2"H x 2 1/2"W x 32"L
Material: Type 304 Stainless Steel
Includes: 1/2" OD drain outlet

Type 304 Stainless Steel Laboratory Pegboards

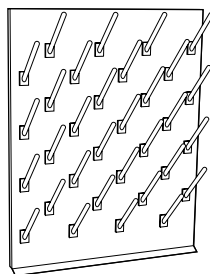

Pegboard without Drip Trough
30" High x 3/4" Thick x 24" Long

X-020008 with Open Back
X-020010 with Finished Back

Peg Size: 1/2" diameter x 6" long
Peg Material: Polypropylene
Peg Color: White
Number of Pegs: 32

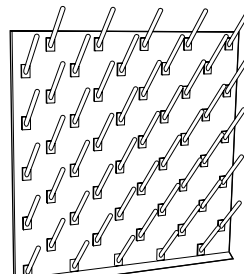

Pegboard without Drip Trough
30" High x 3/4" Thick x 30" Long

X-020009 with Open Back
X-020011 with Finished Back

Peg Size: 1/2" diameter x 6" long
Peg Material: Polypropylene
Peg Color: White
Number of Pegs: 50

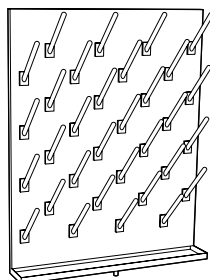

Pegboard with Drip Trough
30" High x 3/4" Thick x 24" Long

X-020004 with Open Back
X-020006 with Finished Back

Peg Size: 1/2" diameter x 6" long
Peg Material: Polypropylene
Peg Color: White
Number of Pegs: 32

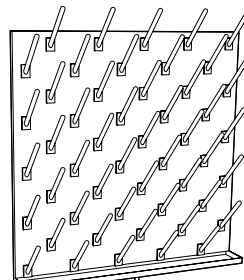

Pegboard with Drip Trough
30" High x 3/4" Thick x 30" Long

X-020005 with Open Back
X-020007 with Finished Back

Peg Size: 1/2" diameter x 6" long
Peg Material: Polypropylene
Peg Color: White
Number of Pegs: 50

Miscellaneous Accessories

Kemresin Balance Table

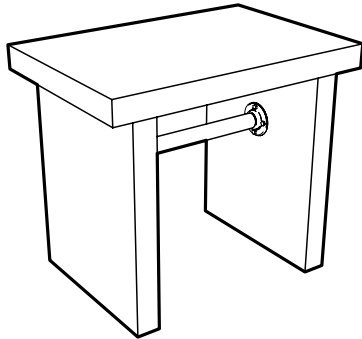

30" High x 24" Deep x 35" Long

K7-302435-BK	Black Kemresin
K7-302435-GR	Grey Kemresin
K7-302435-PT	Grey Kemresin
K7-302435-SL	Slate Kemresin

Work Top: 2" Thick Kemresin
Work Top Size: 2" Thick x 24" Deep x 35" Long
Pedestal Legs: 2" Thick Kemresin
Total Weight: 300 pounds

Marvel Refrigerators & Freezers

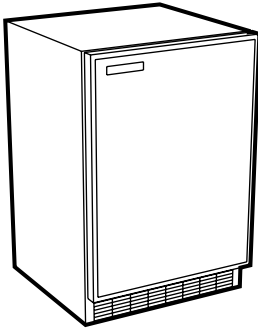

L-110 Combination Refrigerator/Freezer

Size: 34¹/₂" H x 24" D x 23⁷/₈" L — 6.5 cubic feet
Door Swing: Left or Right (User changeable)
Shelves: (1) Removable Wire
Service: Single-phase, 60 hertz, 120 volt AC

L-105 Refrigerator

Same as above except without freezer compartment.

L-115 Freezer

Same as above except entire unit is a freezer.

Base Molding

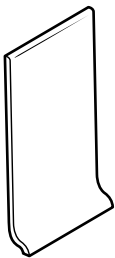

F-0862-04 Base Molding – 48" long, 4" high black base molding. Made of pliable material to match variances in floor surface. Comes with high-strength adhesive applied to back.
Note: Specify number of 4-foot sections required.

Corner Guard

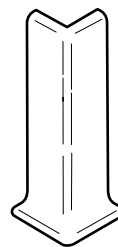

F-1368-00 Base Molding Corner Guard – 4" high black corner guard to finish off outside corner joints of base molding.

Miscellaneous Accessories

Gillis Stainless Steel Cart



F-5349-00 33³/₈" High x 19" Deep x 31" Long

Shelf Size: (3) 18" Deep x 27" Long
(1" high lip on 3 sides of top & middle shelf)

Capacity: 400 pounds

Casters: (4) Black rubber – 4" Diameter – Swivel

Lund Key Cases

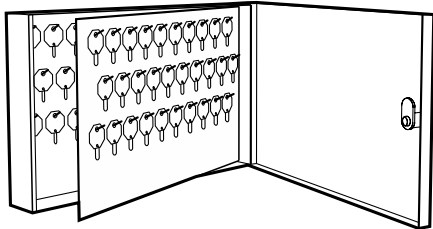

F-5332-00 11" High x 2¹/₂" Deep x 17⁵/₁₆" Long

Key Capacity: 90 Keys

Color: Grey

F-5332-01 24³/₄" High x 2¹/₂" Deep x 17⁵/₁₆" Long

Key Capacity: 200 Keys

Color: Grey

Laboratory Service Fittings

Laboratory Ball Valves (for use with air, vacuum or gases – not to be used for liquids, steam or oxygen)

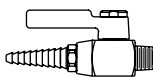

W-0242-00 Gas, Air or Vacuum Valve is chrome plated brass. Valve provides on/off control of gas, air or vacuum at pressures up to 75 PSI. $\frac{3}{8}$ " I.P.S. male inlet.
Specify service desired.

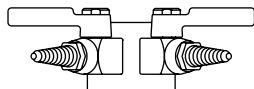

W-0286-02 Double Gas, Air or Vacuum Fitting (curb or panel mounted) is chrome plated brass. Consists of two-way 70° outlet panel flange and two laboratory ball valves. Complete with $\frac{3}{8}$ " I.P.S. tank nipple, locknut and washer.
Specify service desired.

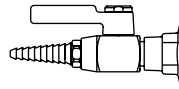

W-0287-00 Gas, Air or Vacuum Fitting (curb or panel mounted) is chrome plated brass. Consists of a single outlet panel flange and a laboratory ball valve. Complete with a $\frac{3}{8}$ " I.P.S. tank nipple, locknut and washer.
Specify service desired.

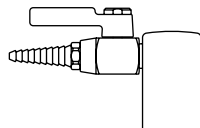

W-0260-00 Gas, Air or Vacuum Deck Mounted Fitting is chrome plated brass. Consists of a single outlet turret with a laboratory ball valve. Complete with a $\frac{3}{8}$ " I.P.S. tank nipple, locknut and washer.
Specify service desired.

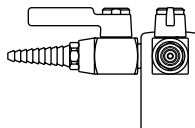

W-0263-00 Double Gas, Air or Vacuum Deck Mounted Fitting Same as No. W-0260-00 except consists of a 2-way 90° outlet turret and two laboratory ball valves. Complete with a $\frac{3}{8}$ " I.P.S. tank nipple, locknut and washer.
Specify service desired.

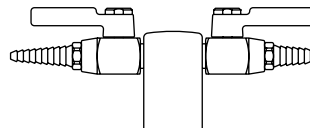

W-0266-00 Double Gas, Air or Vacuum Deck Mounted Fitting Same as No. W-0260-00, except consists of a 2-way 180° outlet turret and two laboratory ball valves. Complete with a $\frac{3}{8}$ " I.P.S. tank nipple, locknut and washer.
Specify service desired.

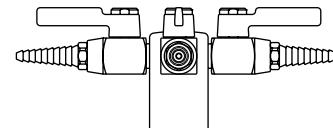

W-0272-00 Quadruple Gas, Air or Vacuum Deck Mounted Fitting Same as W-0260-00, except consists of a 4-way outlet turret and four valves. Complete with a $\frac{3}{8}$ " I.P.S. tank nipple, locknut and washer.
Specify service desired.

Needle Point Cock Valves (for use with air, vacuum or gases – not to be used for liquids or steam)

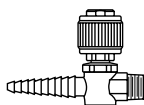

W-0243-00 Gas, Air or Vacuum Valve is chrome plated brass. Single needle point valve with integral straight serrated hose ends. Brass floating cone and integral brass seat. Valve provides metering control of laboratory gases at pressures up to 60 PSI. $\frac{3}{8}$ " I.P.S. male inlet.
Specify service desired.

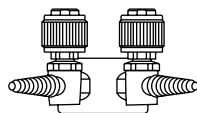

W-0400-00 Double Gas, Air or Vacuum Fitting (curb or panel mounted) with two needle point valves with integral serrated hose ends. Brass floating cone and integral brass seat. Complete with a $\frac{3}{8}$ " I.P.S. tank nipple, locknut and washer.
Specify service desired.

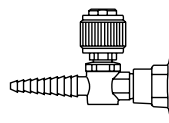

W-0401-00 Gas, Air or Vacuum Fitting (curb or panel mounted) Same as No. W-0400-00 except single needle point valve. Complete with a $\frac{3}{8}$ " I.P.S. tank nipple, locknut and washer.
Specify service desired.

NOTE: If valve is to be used for oxygen service, order W-0243-01.

Laboratory Service Fittings

Needle Point Cock Valves (for use with air, vacuum or gases – not to be used for liquids or steam)

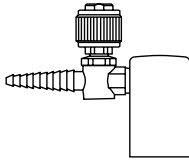

W-0259-00 Single Needle Cock Deck Mounted Fitting
Turret Base is chrome plated brass. Single needle point valve with integral straight serrated hose end. Complete with a 3/8" I.P.S. tank nipple, locknut and washer.
Specify service desired.

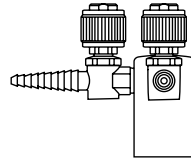

W-0402-00 Double Needle Cock Deck Mounted Fitting
Turret Base is chrome plated brass. Two needle point valves with integral straight serrated hose ends at 90°. Complete with a 3/8" I.P.S. tank nipple, locknut and washer.
Specify service desired.

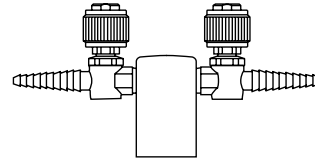

W-0403-00 Double Needle Cock Deck Mounted Fitting
Turret Base is chrome plated brass. Same as No. W-0402-00 except integral straight serrated hose ends are at 180°. Complete with a 3/8" I.P.S. tank nipple, locknut and washer.
Specify service desired.

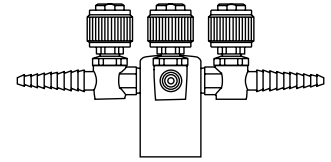

W-0404-00 Quadruple Needle Cock Deck Mounted Fitting
Turret Base is chrome plated brass. Four needle point valves with integral straight serrated hose ends. Complete with a 3/8" I.P.S. tank nipple, locknut and washer.
Specify service desired.

Water Valve

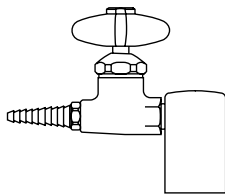

W-0306-00 Water Fitting (deck or panel mounted)
Made of chrome plated brass. Consists of a single outlet turret and a straight water valve with removable straight serrated hose connector. Complete with a 3/8" I.P.S. tank nipple, locknut and washer.

Steam Valves

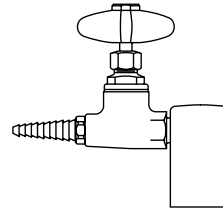

W-0300-00 Steam Fitting (deck or panel mounted)
Made of chrome plated brass. Consists of a single outlet turret and a straight steam valve. Designed for maximum steam pressure of 20 psi. Complete with a 3/8" I.P.S. tank nipple, locknut and washer.

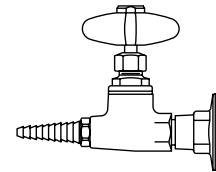

W-0301-00 Steam Fitting (curb or panel mounted)
Made of chrome plated brass. Consists of a single outlet panel flange and a straight steam valve. Designed for maximum steam pressure of 20 psi. Complete with a 3/8" I.P.S. tank nipple, locknut and washer.

Multiple Service Fitting

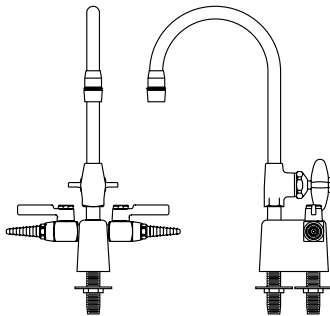

W-0273-02 Deck Mounted Combination Water/Gas Fitting Made of chrome plated brass. Water faucet has a 6" spread gooseneck with removable aerator outlet and disc type valve. Includes a two-way turret with two laboratory ball valves set at 180°. Complete with two 3/8" I.P.S. tank nipples, locknuts and washers.
(Specify service desired for ball valves.)

W-0273-VB Deck Mounted Combination Water/Gas Fitting
Same as W-0273-02 except furnished with vacuum breaker type gooseneck and removable straight serrated hose connector.
(Specify service desired for ball valves.)

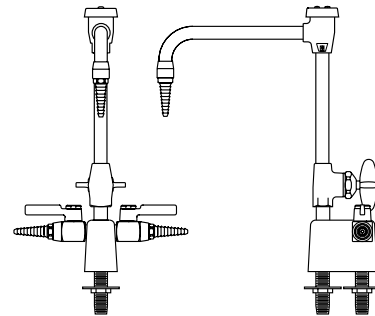

W-0274-VB Deck Mounted Combination Water/Gas Fitting Made of chrome plated brass. Water faucet has a 8" spread vacuum breaker type gooseneck with removable straight serrated hose connector and disc type valve. Includes a two-way turret with two laboratory ball valves set at 180°. Complete with two 3/8" I.P.S. tank nipples, locknuts and washers.
(Specify service desired for valves.)

W-0274-02 Deck Mounted Combination Water/Gas Fitting
Same as W-0274-VB except furnished with standard gooseneck and removable aerator outlet.
(Specify service desired for valves.)

Laboratory Service Fittings

Single Water Faucet

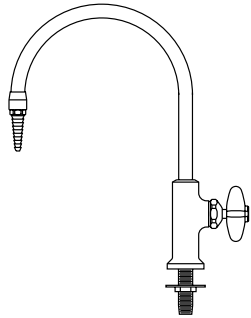

W-0337-00 Deck Mounted Gooseneck Water Faucet
 Chrome plated brass with an 8" spread rigid gooseneck. Removable straight serrated hose connector. Valve is disc type with a renewable internal assembly. Faucet body is furnished with a 3/8" I.P.S. threaded mounting shank with locknut and washer.

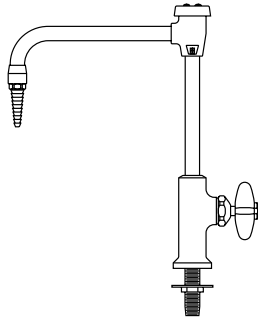

W-0337-0V Deck Mounted Vacuum Breaker Gooseneck Water Faucet
 Same as W-0337-00 except furnished with 8" spread rigid vacuum breaker type gooseneck.

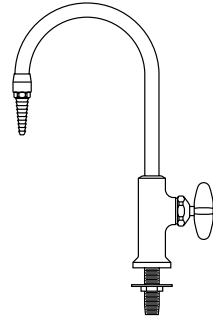

W-0337-06 Deck Mounted Gooseneck Water Faucet
 Same as W-0337-00 except furnished with 6" spread rigid gooseneck.

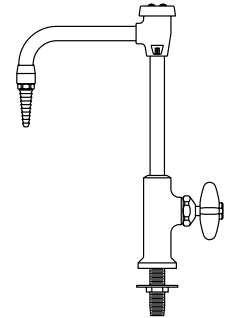

W-0337-6V Deck Mounted Vacuum Breaker Gooseneck Water Faucet
 Same as W-0337-0V except furnished with 6" spread rigid vacuum breaker type gooseneck.

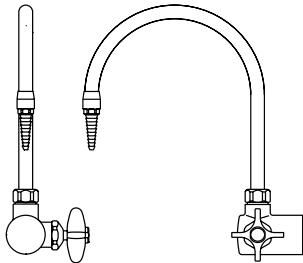

W-0350-00 Right Hand Curb Mounted Gooseneck Water Faucet
 Made of chrome plated brass. Has an 8" spread rigid gooseneck with removable straight serrated hose connector. Valve is disc type with renewable internal assembly. Flanged inlet is complete with 1/2" I.P.S. tank nipple, locknut and washer.

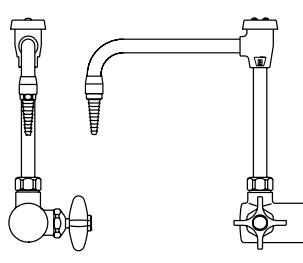

W-0350-0V Right Hand Curb Mounted Vacuum Breaker Gooseneck Water Faucet
 Same as W-0350-00 except supplied with vacuum breaker type gooseneck.

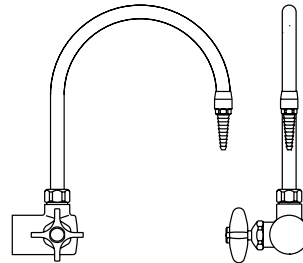

W-0351-00 Left Hand Curb Mounted Gooseneck Water Faucet
 Same as W-0350-00 except supplied with valve handle on left.

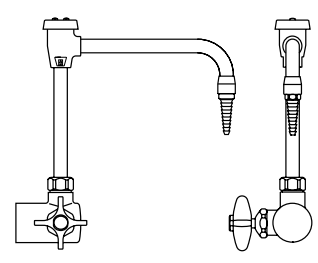

W-0351-0V Left Hand Curb Mounted Vacuum Breaker Gooseneck Water Faucet
 Same as W-0350-0V except supplied with valve handle on left.

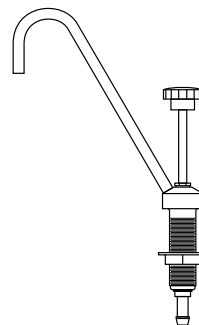

W-0405-00 Portable Pump Gooseneck Faucet for laboratory demonstration table. Made of chrome plated brass with 7 5/8" spread, rigid, 1/4" I.P.S. gooseneck. Faucet/pump body is complete with an integral threaded mounting shank and flanged locknut. 5/8" O.D. hose connector inlet.

Laboratory Service Fittings

Mixing Faucet

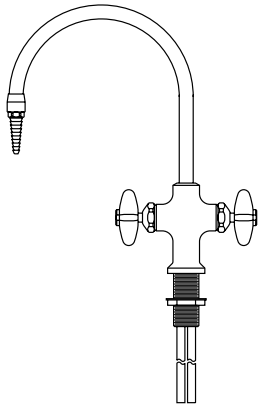

W-0340-00 Deck Mounted Hot and Cold Water Mixing Gooseneck Faucet Made of chrome plated brass with an 8" spread rigid gooseneck. Removable straight serrated hose connector. Valves are disc type with renewable internal assemblies. Faucet body is complete with an integral threaded mounting shank and a flanged locknut. Furnished with 1/2" O.D. slip joint coupling nuts for 3/8" tubing.

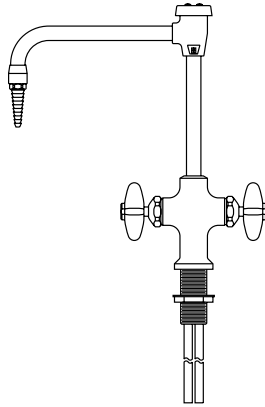

W-0340-0V Deck Mounted Hot and Cold Water Mixing Vacuum Breaker Gooseneck Faucet Same as W-0340-00 except supplied with vacuum breaker type gooseneck.

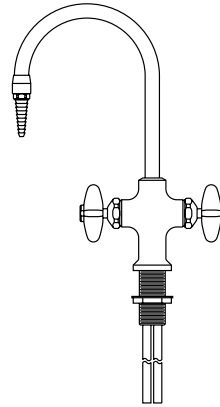

W-0340-06 Deck Mounted Hot and Cold Water Mixing Vacuum Breaker Gooseneck Faucet Same as W-0340-00 except furnished with 6" spread rigid gooseneck.

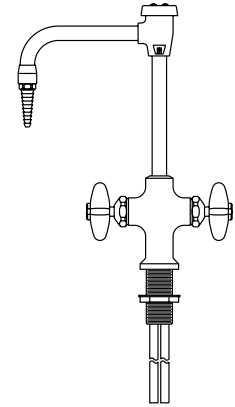

W-0340-6V Deck Mounted Hot and Cold Water Mixing Vacuum Breaker Gooseneck Faucet Same as W-0340-0V except furnished with 6" spread rigid vacuum breaker type gooseneck.

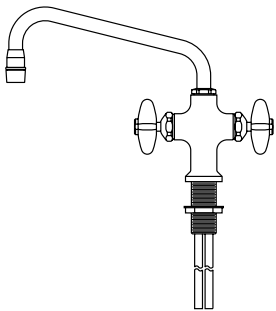

W-0333-00 Deck Mounted Hot and Cold Water Mixing Swing Spout Faucet Made of chrome plated brass. Has a 9" spread swinging spout with anti-splash outlet. Valves are disc type with renewable internal assemblies. Faucet body is complete with an integral threaded shank and a flanged locknut. Furnished with 1/2" O.D. slip joint coupling nuts for 3/8" tubing.

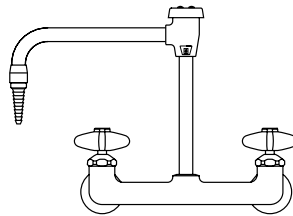

W-0354-00 Curb Mounted Hot and Cold Water Mixing Gooseneck Faucet Made of chrome plated brass. Has an 8" spread rigid gooseneck with removable straight serrated hose connector. Valves are disc type with renewable internal assemblies. Flanged inlets are complete with 3/8" I.P.S. tank nipples, locknuts and washers on 8" centers.

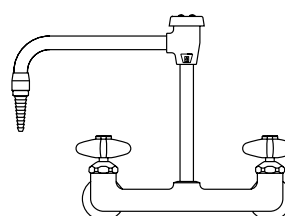

W-0354-0V Curb Mounted Hot and Cold Water Mixing Vacuum Breaker Gooseneck Faucet Same as No. W-0354-00 except supplied with vacuum breaker type gooseneck.

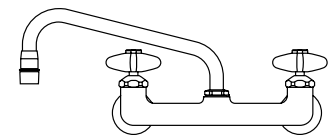

W-0355-00 Curb Mounted Hot and Cold Water Mixing Swing Spout Faucet Made of chrome plated brass. Has a 9" spread swinging spout with anti-splash outlet. Valves are disc type with renewable internal assemblies. Flanged inlets are complete with 3/8" I.P.S. tank nipples, locknuts and washers on 8" centers.

Laboratory Service Fittings

Mixing Faucet

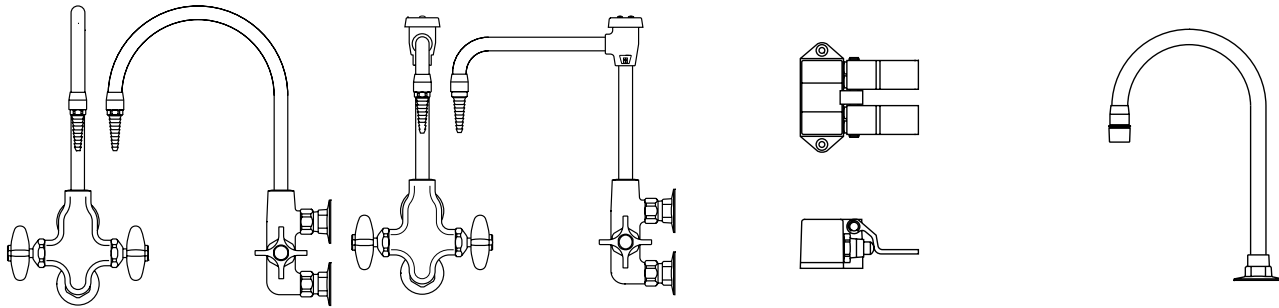

W-0361-00 Panel Mounted Hot and Cold Water Mixing Gooseneck Faucet Chrome plated brass. Designed for mounting on facia type reagent rack plumbing box uprights. It has an 8" spread rigid gooseneck equipped with a removable straight serrated hose connector. Valves are disc type with renewable internal assemblies. Flanged inlets on 3" centers are complete with 3/8" I.P.S. tank nipples, locknuts and washers.

W-0361-0V Panel Mounted Hot and Cold Water Mixing Vacuum Breaker Gooseneck Faucet Same as W-0361-00 except supplied with vacuum breaker type gooseneck.

W-0825-00 Floor Mounted Foot Control Double Pedal Mixing Valve is chrome plated brass. Has twin pedals with self-closing valves for mixing hot and cold water. 1/2" I.P.S. female thread inlets and outlet at the rear. Inlets are on 2" centers, 7/8" above floor. Outlet is on center 1 1/2" above floor.

W-0833-00 Deck Mounted Water Gooseneck Fitting is chrome plated brass. Consisting of a 8" gooseneck with mounting flange and W-0532-00 aerator. 3/8" I.P.S. female thread inlet complete with tank nipple, lock-nut and washer. **Intended for use as an outlet for W-0825-00.**

Faucet Accessories/Options

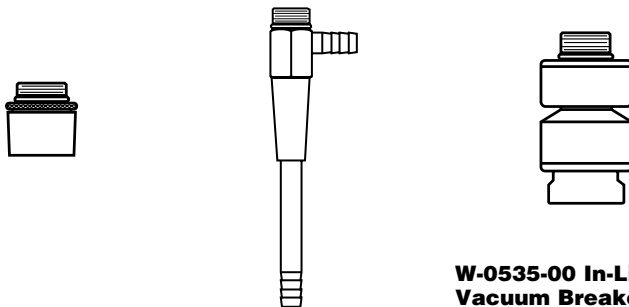

W-0532-00 Aerator
Anti-splash aerator can be used in lieu of the removable straight serrated hose connectors supplied with the gooseneck water faucet. 3/8" I.P.S. male thread inlet.

W-0510-00 Filter Pump (Aspirator) 5 1/2" high overall. Has serrated hose connector side and bottom outlets. 3/8" I.P.S. male thread inlet.

W-0535-00 In-Line Vacuum Breaker
Chrome plated. Mounts between the outlet end of a fitting (gooseneck, flange, etc.) and a removable serrated hose connector. 3/8" I.P.S. male thread inlet and female thread outlet. (Check plumbing codes for required location of vacuum breakers before ordering.)

Laboratory Service Fittings

Distilled Water Faucet

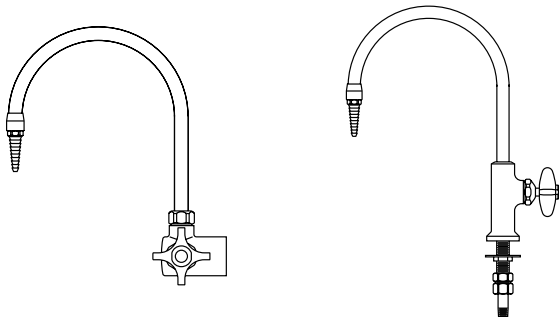

W-0367-00 Right Hand Distilled Water (Curb or Panel Mounted) Faucet

Chrome plated with a hot tin lined interior. It has a self-closing handle and a disc type valve with a renewable internal assembly. The 8" spread rigid gooseneck has a removable serrated hose end. 1/2" I.P.S. flanged female thread inlet complete with tank nipple, locknut and washer.

W-0368-00 Deck Mounted Distilled Water Gooseneck Faucet

Made of chrome plated brass. Has a hot tin lined interior. It has a self-closing handle and a disc type valve with renewable internal assembly. The 8" spread rigid gooseneck has a removable serrated hose end. Faucet body is complete with an integral threaded mounting shank and a flanged locknut. 1/2" I.P.S. male thread inlet with coupling nut and 1/4" I.P.S. tailpiece.

Ultra-Pure Deionized Water Faucet

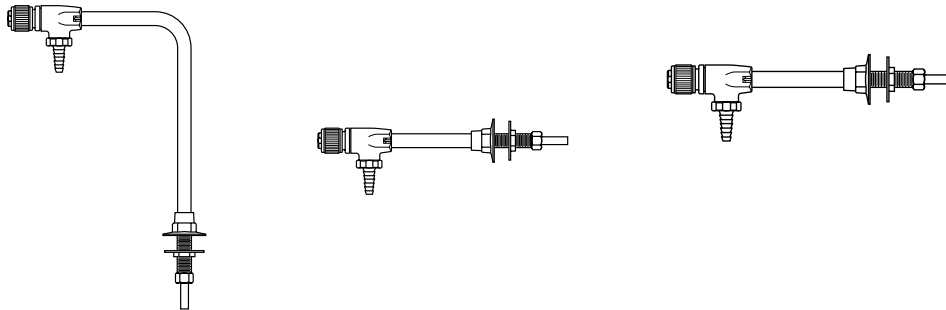

W-0407-00 Distilled, Deionized and Ultra-Pure Water Faucet (deck mounted)

made of chrome plated brass. All polypropylene internal construction with 6" spread gooseneck. Furnished with 1/2" I.P.S. shank with locknut and washer. Inlet is 3/8" O.D. compression.

W-0408-00 Distilled, Deionized and Ultra-Pure Water Faucet (panel mounted)

made of chrome plated brass. All polypropylene internal construction with 6" spread gooseneck. Furnished with 1/2" I.P.S. shank with locknut and washer. Inlet is 3/8" O.D. compression.

W-0409-00 Distilled Deionized and Ultra-Pure Water Faucet (panel mounted)

made of chrome plated brass. All polypropylene internal construction with 8" spread gooseneck. Furnished with 1/2" I.P.S. shank with locknut and washer. Inlet is 3/8" O.D. compression.

Laboratory Service Fittings

Vandal-Resistant Fittings

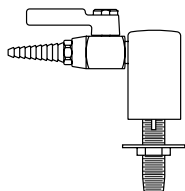

W-0410-VR Vandal Resistant Deck Mounted Gas, Air or Vacuum Fitting with single vandal-resistant laboratory ball valve. Complete with a 3/8" I.P.S. tank nipple, locknut and washer. **Specify service desired.**

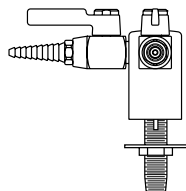

W-0411-VR Vandal Resistant Deck Mounted Double Gas, Air or Vacuum Fitting with two vandal-resistant laboratory ball valves with integral straight serrated hose ends at 90°. Complete with a 3/8" I.P.S. tank nipple, locknut and washer. **Specify service desired.**

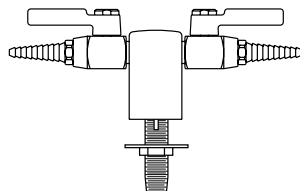

W-0412-VR Vandal Resistant Deck Mounted Double Gas, Air or Vacuum Fitting Same as W-0411-VR except at 180°. Complete with a 3/8" I.P.S. tank nipple, locknut and washer. **Specify service desired.**

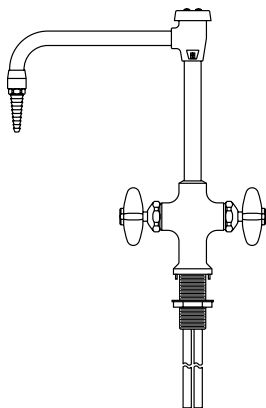

W-0413-VR Vandal Resistant Deck Mounted Hot and Cold Mixing Faucet with 8" rigid vacuum breaker gooseneck. Valves are disc type with renewable internal assemblies. Faucet body is complete with an integral threaded mounting shank and a flanged locknut. 1/2" I.P.S. male thread inlets with coupling nuts for slip joint connections.

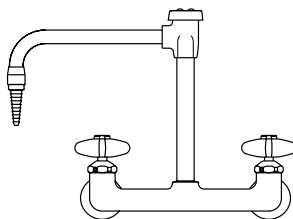

W-0414-VR Vandal Resistant Panel Mounted Hot and Cold Mixing Faucet with 8" rigid vacuum breaker gooseneck and mounting shanks.

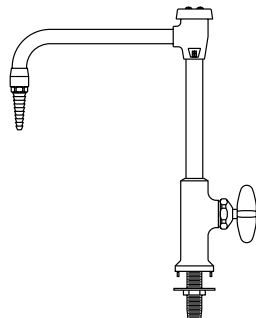

W-0415-VR Vandal Resistant Deck Mounted Water Faucet with 8" rigid vacuum breaker gooseneck. Furnished with 3/8" I.P.S. treaded mounting shank with locknut and washer.

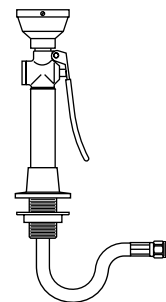

W-0417-VR Vandal Resistant Deck Mounted Hand-Held Drench Hose with single spray type outlet heads, squeeze-lever operated valve and flexible stainless steel hose. 3/8" I.P.S. male inlet.

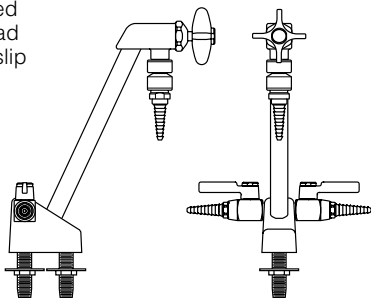

W-0416-VB Vandal Resistant Deck Mounted Combination Vacuum Breaker Water/Gas Fitting Made of chrome plated base. Rigid gooseneck with disc type valve and in-line vacuum breaker. Includes two-way turret with two laboratory ball valves. Complete with two 3/8" I.P.S. tank nipples, locknuts and washers. **Specify service desired.**

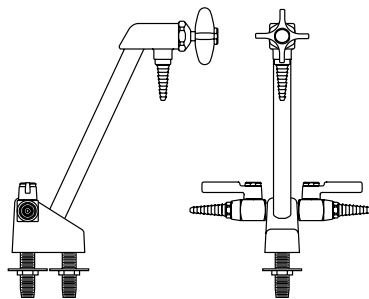

W-0416-VR Vandal Resistant Deck Mounted Combination Water/Gas Fitting Same as W-416-VB except furnished without in-line vacuum breakers. **Specify service desired.**

Laboratory Service Fittings

Emergency Eye Wash/Shower Equipment

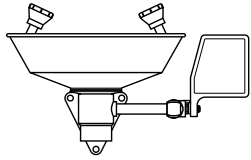

W-0927-00 Panel Mounted Eye Wash Fixture Consists of stainless steel bowl, two Gentle Spray outlet heads, a "PUSH TO OPERATE" ball valve and mounting bracket. 1/2" I.P.S. female thread inlet and 1 1/8" I.P.S. female thread outlet.

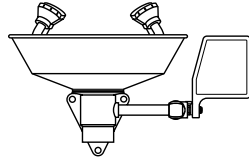

W-0933-00 Eye/Face Wash (wall mounted) the same as No. W-0927-00, except with four Gentle Spray outlet heads for complete coverage of eyes and face.

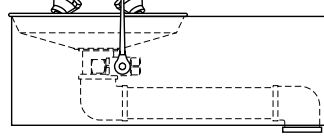

W-0930-00 BARRIER-FREE (ADA) Eye/Face Wash (wall mounted) with four Gentle Spray outlet heads, stainless steel skirt and bowl and stay-open ball valve. 1/2" I.P.S. female thread inlet and 1 1/8" I.P.S. female thread outlet.

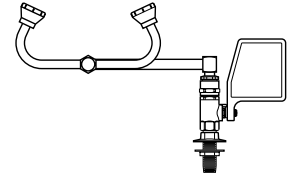

W-0931-00 Eye Wash (deck mounted) with two Gentle Spray outlet heads, stay-open ball valve and 90° swivel feature (right hand mounting).

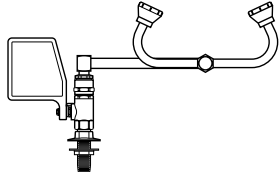

W-0932-00 Eye Wash (deck mounted) the same as No. W-0931-00 but (left hand mounting).

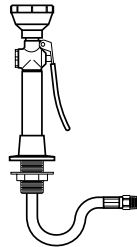

W-0923-00 Deck Mounted Hose Spray Fitting Consists of 8 ft. reinforced PVC hose with a squeeze-lever operated valve and spray-type outlet head with a protective rubber collar. Flange, shank and locknut for attaching to table top are included. 3/8" I.P.S. male thread swivel inlet.

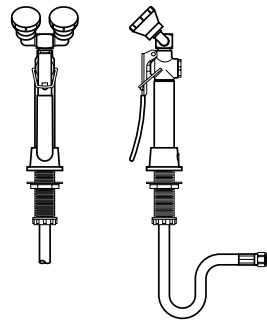

W-0934-00 Deck Mounted Dual Purpose Eye Wash/Drench Hose with two Gentle Spray outlet heads angled at 45° and squeeze valve with locking clip. Flange, shank and locknut for attaching to table top are included. 3/8" I.P.S. male thread swivel inlet.

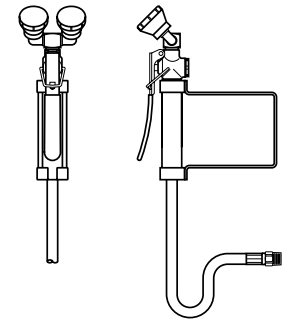

W-0935-00 Wall Mounted Dual Purpose Eye Wash/Drench Hose the same as No. W-0934-00 except wall mounted.

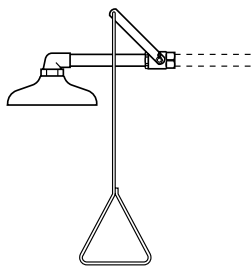

W-0374-01 Emergency Shower Head Assembly (horizontally mounted). Includes 10" diameter orange ABS plastic shower head. Operated by a rigid pull-rod and easy to grip handle. Complete with an elbow, connecting pipe and ball valve. 1" I.P.S. female thread inlet.

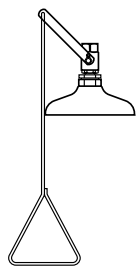

W-0928-00 Emergency Shower Head Assembly (vertically mounted). The same as No. W-0374-01 except vertically mounted.

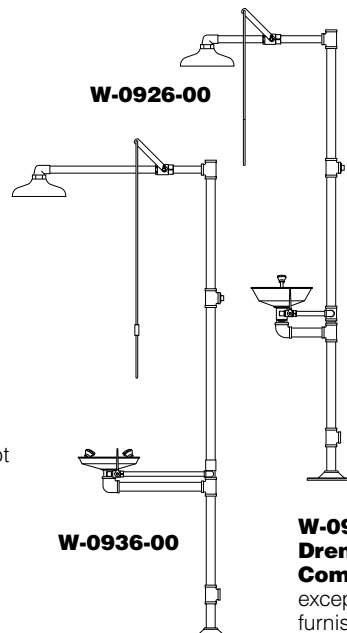

W-0926-00 Drench Shower and Eye Wash Combination A necessity for chemical stockrooms and other areas handling a quantity of corrosive chemicals. Free-standing 10" dia. drench shower made of orange ABS plastic. Has a 1" ball valve operated by a rigid pull-rod and easy to grip handle. Eye wash fixture with stainless steel bowl, two Gentle Spray heads and a "PUSH TO OPERATE" ball valve. Eye wash and shower operate independently. Overall height is 7'6". 1 1/8" I.P.S. female thread inlet and outlet.

W-0936-00

W-0936-00 BARRIER-FREE (ADA) Drench Shower and Eye Wash Combination Similar to No. W-0926-00 except this unit is barrier-free and eye wash furnished with four Gentle Spray heads.

Cupsinks & Drain Accessories

Cupsinks



0490-BE Black Epoxy
0490-GE Grey Epoxy
0490-PE Putty Epoxy
0490-SE Slate Epoxy
 Complete with removable strainer. 6"x 3" inside dimension. 1 1/2" I.P.S. male straight thread outlet.
 (Overall height is 7 1/2")



0491-BP Black Poly
0491-GP Grey Poly
 Complete with removable strainer. 6"x 3" inside dimension. 1 1/2" I.P.S. male straight thread outlet.
 (Overall height is 8 1/2")



0492-BP Black Poly
0492-GP Grey Poly
 Complete with removable strainer. 9"x 3" inside dimension. 1 1/2" I.P.S. male straight thread outlet.
 (Overall height is 7")



0493-BE Black Epoxy
0493-GE Grey Epoxy
0493-PE Putty Epoxy
0493-SE Slate Epoxy
 Complete with removable type 316 stainless steel wire screen. 13 3/8" x 4 1/8" x 5 1/4" I.D. 1 1/2" I.P.S. male straight thread outlet.
 (Overall height is 8")

Stainless Steel Cupsinks



0950-0F Stainless Steel
 Made of type 304 stainless steel and has integral cross bars. 5" I.D. 1 1/2" I.P.S. male straight thread outlet.



0975-0F Stainless Steel
 Made of type 316 stainless steel and has integral cross bars. 6"x 3" I.D. 1 1/2" I.P.S. male straight thread outlet.

Drain Accessories

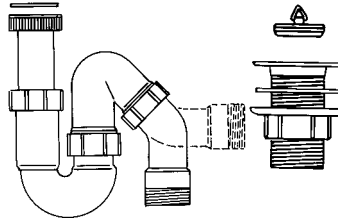

0464-00 Polyethylene Trap and Sink Outlet
 Adjustable riser (tailpiece) can be cut to the desired length. Sink outlet is complete with plug strainer, gasket and locknut. Has a 1 1/2" I.P.S. male straight thread outlet. Running type trap can be used for either "P" or "S" type drain connections. 1 1/2" I.P.S. male straight thread outlet.

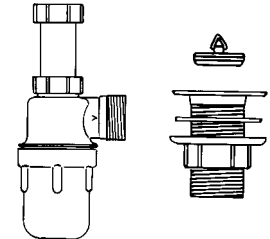

0469-00 Polyethylene Trap and Sink Outlet
 Adjustable riser (tailpiece) with 4 1/2" adjustment that does not require cutting. The sink outlet is complete with plug, strainer, gasket and locknut. Has a 1 1/2" I.P.S. male straight thread outlet. Trap is the bottle "P" type, with removable bottom for cleanout. 1 1/2" I.P.S. male straight thread outlet.

Sink Outlet



0482-BP Black Poly
0482-GP Grey Poly
 Complete with locknut. 1 1/2" I.P.S. male straight thread outlet. For use with epoxy resin tub sinks and troughs.

Sink Overflow



0494BP-04 4" High
0494BP-06 6" High
0494BP-08 8" High
0494BP-10 10" High
 Sink Overflows are designed to be used with 0482-BP sink outlets. 1 1/2" diameter.

St. Steel Sink Drain

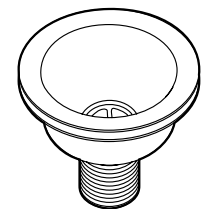

0995-00 Stainless Steel
 Crumb Cup Strainer
 Complete with gaskets, locknut and basket strainer. 1 1/2" male straight thread outlet.

Kemresin Tub Sinks & Drain Troughs

Kemresin® Tub Sinks and Drain Troughs are made from a combination of modified epoxy resins, upgraded for maximum properties with carefully selected curing resins and inert fillers to produce a thermosetting material. They are formed in metal molds to provide one-piece units with covered corners and bottoms pitched to the drain outlet. After being removed

from the molds, they are cured at high temperatures for several hours to complete the chemical reaction, and ensure maximum chemical impact and thermal shock resistance. Drain outlets are sized for 1 1/2" sink outlets unless otherwise specified.

Kemresin Drain Troughs are molded with no longitudinal joints. A slope of 1/8" per foot assures complete drainage and a 7/8" cove radius in the

bottom corners is provided for ease of cleaning. Five trough sections, or any part of them, are available to be cemented together to provide Open End Troughs up to 21' long, Closed End Troughs with an end drain outlet up to 21'-8" long, and Closed End Troughs with a center drain outlet up to 42'-8" long. Section TR-4 is provided with a center drain recess for a standard 1 1/2" sink outlet.

Epoxy Resin Drain Troughs

Epoxy Resin Tub Sinks

Closed End Trough



Open End Trough



Double Tub Sink

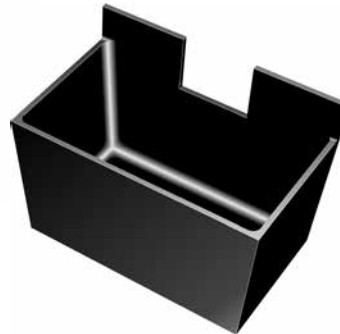

Center Bench End Sink with Trough Cutout



Single Tub Sink

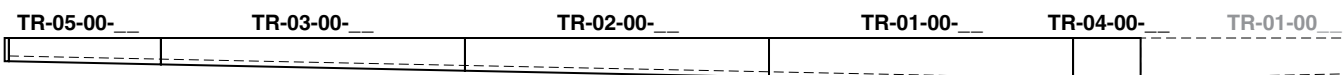
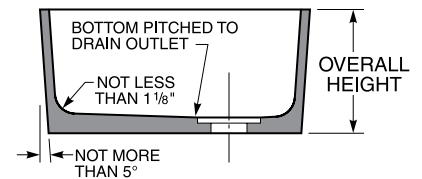
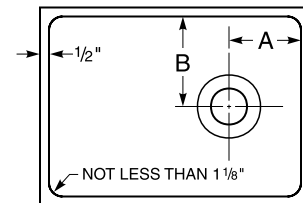
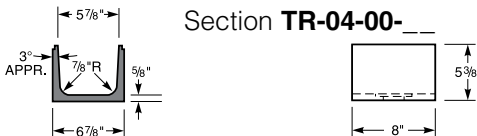
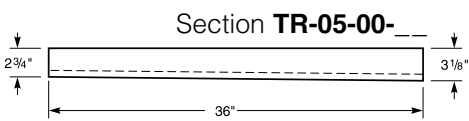
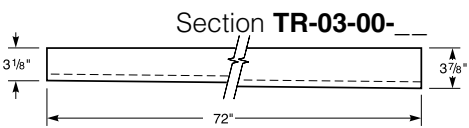
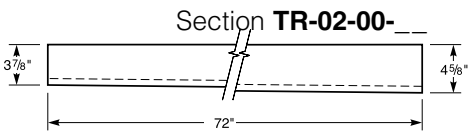
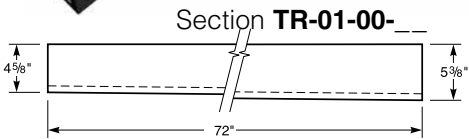

Kemresin Tub Sinks & Drain Troughs

Kemresin Colors

Kemresin® Tub Sinks and Drain Troughs are available in four standard colors: Black, Grey, Putty, and Slate.

To specify color, add color code to the end of the part number.
Example: 1005-00-BK

Color Codes

BK = Black **PT** = Putty
GR = Grey **SL** = Slate

Kemresin Tub Sinks

Catalog Number	Inside Dimensions (at Top of Sink)			Drain Location		Overall Sink Height
	Length	Width	Height	A	B	
1000-00 ---	14"	10"	6"	4"	5"	6 ⁷ / ₈ "
1001-00 ---	16"	8"	7"	4"	4"	8"
1003-00 ---	18"	15"	11 ¹³ / ₁₆ "	4"	4"	12 ⁷ / ₈ "
(1) 1003-DT ---	37"	15"	11"	4 ¹ / ₂ "	4 ¹ / ₂ "	12"
1005-00 ---	25"	15"	10"	4"	4"	11 ¹ / ₄ "
1006-00 ---	18"	15"	8"	4"	4"	9"
(2) 1006-DT ---	36 ³ / ₄ "	15"	8 ¹ / ₄ "	4 ¹ / ₂ "	4 ¹ / ₂ "	9"
1007-00 ---	24"	16"	8"	4"	8"	9 ¹ / ₈ "
1008-00 ---	16"	12"	8"	4"	6"	9 ¹ / ₈ "
1011-00 ---	18"	6 ¹ / ₂ "	6"	9"	3 ¹ / ₄ "	7"
(3) 1014-00 ---	25"	15"	10"	4"	4"	11 ¹ / ₄ "
(4) 1015-00 ---	23 ³ / ₈ "	13 ³ / ₄ "	13 ¹ / ₄ "	11 ¹¹ / ₁₆ "	9 ¹ / ₂ "	17 ³ / ₄ "
(5) 1016-00 ---	23 ³ / ₈ "	13 ³ / ₄ "	13 ¹ / ₄ "	11 ¹¹ / ₁₆ "	9 ¹ / ₂ "	17 ³ / ₄ "
1021-00 ---	16"	16"	7 ¹ / ₂ "	4"	4"	8 ³ / ₄ "
1022-00 ---	21"	18"	10"	4 ¹ / ₂ "	9"	11"
1023-00 ---	21 ¹ / ₂ "	15 ¹ / ₂ "	7"	4"	4"	8 ³ / ₈ "
1024-00 ---	21 ¹ / ₂ "	15 ¹ / ₂ "	11"	4"	4"	12 ¹ / ₈ "
(6) 1024-DT ---	44"	15 ¹ / ₂ "	11"	4"	4"	12 ¹ / ₂ "
1025-00 ---	28"	20"	9 ¹ / ₈ "	14"	6"	10 ¹ / ₈ "
1026-00 ---	35 ¹ / ₂ "	19 ¹ / ₂ "	10"	17 ³ / ₄ "	9 ³ / ₄ "	11 ¹ / ₈ "
1027-00 ---	42"	20"	10"	21"	10"	11 ¹ / ₄ "
1030-00 ---	16"	12"	8"	8"	6"	9"
1031-00 ---	24"	16"	8"	12"	8"	9"
1032-00 ---	29 ³ / ₄ "	14 ³ / ₄ "	6"	14 ⁷ / ₈ "	7 ³ / ₈ "	7"
1034-00 ---	21 ¹ / ₂ "	19 ¹ / ₄ "	8"	10 ³ / ₄ "	9 ⁵ / ₈ "	9 ¹ / ₈ "
1035-00 ---	45 ³ / ₄ "	17 ³ / ₈ "	12 ¹ / ₂ "	22 ⁷ / ₈ "	8 ³ / ₄ "	13 ³ / ₈ "
1036-00 ---	48 ⁵ / ₈ "	24 ¹ / ₂ "	5 ³ / ₈ "	3 ³ / ₄ "	12 ¹ / ₄ "	6"
(7) 1037-00 ---	23 ¹ / ₄ "	14 ¹ / ₄ "	12 ³ / ₄ "	11 ⁵ / ₈ "	9 ¹ / ₄ "	22 ³ / ₈ "
(8) 1038-00 ---	12" diameter		7 ⁵ / ₈ "	center		8 ³ / ₈ "
(9) 1039-00 ---	18" diameter		8 ¹ / ₈ "	center		8 ⁷ / ₈ "
SM-01-00 ---	12"	6"	6"	6"	3"	7"
SM-02-00 ---	19 ¹ / ₂ "	16 ¹ / ₂ "	8"	9 ³ / ₄ "	8 ¹ / ₄ "	9"
SM-03-00 ---	24"	21"	8"	6"	4 ¹ / ₂ "	9 ¹ / ₈ "
SM-04-00 ---	25 ¹ / ₂ "	16 ¹ / ₂ "	19"	4 ¹ / ₂ "	4 ¹ / ₂ "	20 ¹ / ₈ "
SM-05-00 ---	28"	18"	10"	4"	4"	11 ¹ / ₈ "
SM-06-00 ---	28"	18"	10"	24"	4"	11 ¹ / ₈ "
SM-07-00 ---	30"	16"	10"	4"	4"	11 ¹ / ₈ "
SM-08-00 ---	30"	16"	10"	26"	4"	11 ¹ / ₈ "
SM-09-00 ---	30"	18"	18"	4 ¹ / ₂ "	4 ³ / ₄ "	18 ³ / ₄ "
SM-10-00 ---	36"	21"	4 ³ / ₄ "	4"	4"	5 ³ / ₄ "
SM-11-00 ---	48"	13"	12 ¹ / ₄ "	24"	6 ¹ / ₂ "	13 ¹ / ₄ "
SM-12-00 ---	8"	8"	8"	4"	4"	8 ⁷ / ₈ "

Catalog Number	Inside Dimensions (at Top of Sink)			Drain Location		Overall Sink Height
	Length	Width	Height	A	B	
SM-13-00 ---	14"	10"	8"	4"	5"	9"
SM-14-00 ---	23 ¹ / ₄ "	14 ¹ / ₄ "	12 ³ / ₄ "	11 ⁵ / ₈ "	9 ¹ / ₄ "	13 ⁵ / ₈ "
SM-15-00 ---	19 ³ / ₄ "	18"	24"	9 ⁷ / ₈ "	9"	25"
SM-16-00 ---	40"	18"	18 ¹ / ₄ "	20"	9"	19 ¹ / ₄ "
SM-17-00 ---	29 ³ / ₄ "	23 ¹ / ₂ "	6"	14 ⁷ / ₈ "	11 ³ / ₄ "	7"
SM-18-00 ---	18"	15"	15 ¹ / ₄ "	4 ³ / ₄ "	4 ³ / ₄ "	16 ¹ / ₂ "
SM-19-00 ---	35 ¹ / ₂ "	19 ¹ / ₂ "	15 ³ / ₈ "	3 ¹ / ₂ "	4 ¹ / ₂ "	16 ¹ / ₂ "
SM-20-00 ---	21"	18"	15 ¹ / ₄ "	4 ¹ / ₂ "	4 ¹ / ₂ "	16 ¹ / ₂ "
SM-21-00 ---	60 ¹ / ₂ "	22"	7 ¹ / ₄ "	6"	6"	8 ¹ / ₈ "
SM-22-00 ---	24"	16"	15 ³ / ₈ "	12"	8"	16 ¹ / ₈ "
SM-23-00 ---	28"	18"	15 ¹ / ₂ "	5 ¹ / ₂ "	4"	16 ¹ / ₂ "
SM-24-00 ---	48"	8"	8"	24"	4"	9"
SM-25-00 ---	21"	18"	15 ¹ / ₈ "	10 ¹ / ₂ "	9"	16 ¹ / ₈ "
SM-26-00 ---	21"	11 ³ / ₈ "	15 ¹ / ₈ "	10 ¹ / ₂ "	5 ¹¹ / ₁₆ "	16 ¹ / ₈ "
SM-27-00 ---	36"	20"	16 ¹ / ₄ "	18"	10"	17 ¹ / ₄ "
SM-28-00 ---	30"	18"	4 ¹ / ₈ "	15"	9"	5 ¹ / ₄ "
SM-29-00 ---	36"	24"	12 ¹ / ₄ "	18"	12"	13 ¹ / ₄ "
SM-30-00 ---	40"	30"	8 ¹ / ₈ "	20"	15"	9"
SM-31-00 ---	24"	15 ³ / ₄ "	12 ¹ / ₈ "	4 ³ / ₄ "	8"	13"
SM-32-00 ---	59"	21"	12 ⁵ / ₈ "	29 ¹ / ₂ "	10 ¹ / ₂ "	13 ³ / ₈ "
SM-33-00 ---	24"	18"	11"	4"	9"	11 ⁷ / ₈ "
(10) SM-34-00 ---	15"	14"	10 ¹ / ₂ "	7 ¹ / ₂ "	7"	11 ¹ / ₄ "
SM-35-00 ---	51"	17"	12 ¹ / ₂ "	25 ¹ / ₂ "	8 ¹ / ₂ "	13 ¹ / ₄ "
SM-36-00 ---	14"	10"	6"	7"	5"	6 ⁷ / ₈ "
(11) SM-37-00 ---	24"	20"	10 ⁵ / ₈ "	6 ³ / ₄ "	10"	11 ¹ / ₄ "
SM-39-00 ---	35"	6 ⁵ / ₈ "	4 ³ / ₄ "	17 ¹ / ₂ "	3 ⁵ / ₁₆ "	5 ¹ / ₂ "
SM-40-00 ---	33 ³ / ₈ "	29 ¹ / ₈ "	15 ³ / ₄ "	6"	14 ⁹ / ₁₆ "	16 ¹ / ₂ "
SM-41-00 ---	18"	15"	8 ¹ / ₄ "	9"	7 ¹ / ₂ "	9"
SM-42-00 ---	25"	15"	10 ¹ / ₂ "	12 ¹ / ₂ "	7 ¹ / ₂ "	11 ¹ / ₄ "
SM-43-00 ---	21"	18"	10 ³ / ₈ "	10 ¹ / ₂ "	9"	11 ¹ / ₈ "
SM-44-00 ---	36"	16"	11"	12"	4"	12"
SM-45-00 ---	27 ³ / ₄ "	14 ³ / ₄ "	8 ¹ / ₂ "	10 ¹ / ₂ "	7 ¹ / ₂ "	9 ³ / ₈ "
SM-47-00 ---	43"	15 ¹ / ₂ "	11 ¹ / ₈ "	21 ¹ / ₂ "	7 ³ / ₄ "	12"
SM-48-00 ---	56"	24"	8 ¹ / ₄ "	28"	12"	9"
SM-49-00 ---	36"	16"	8 ³ / ₈ "	6"	8"	9"
SM-50-00 ---	24"	24"	12 ¹ / ₂ "	12"	12"	13 ¹ / ₄ "
SM-51-00 ---	30"	15 ¹ / ₈ "	16 ³ / ₈ "	6"	7 ¹⁵ / ₁₆ "	17 ¹ / ₈ "
SM-52-00 ---	45 ¹ / ₈ "	11 ¹ / ₂ "	8 ¹ / ₈ "	22 ⁹ / ₁₆ "	5 ³ / ₄ "	9"
SM-53-00 ---	31 ¹ / ₂ "	16"	16 ¹ / ₂ "	7 ¹ / ₈ "	8"	17 ¹ / ₄ "
SM-55-00 ---	16"	16"	12 ³ / ₈ "	4 ¹ / ₄ "	4 ¹ / ₄ "	13"
SM-56-00 ---	42 ¹ / ₄ "	18 ¹ / ₈ "	12 ⁵ / ₈ "	21 ¹ / ₈ "	9 ¹ / ₁₆ "	13 ³ / ₈ "

- (1) Double tub sink. Distance between centerlines of drain outlets is 19³/₈".
- (2) Double tub sink. Distance between centerlines of drain outlets is 19".
- (3) Sink has 7¹/₈" long by 5⁵/₈" high trough cutout.
- (4) Center table end sink has 7¹/₈" long by 5⁵/₈" high trough cutout and 24¹/₂" long by 3³/₄" high back splash. Table side of sink is not tapered.
- (5) Center table end sink has 24¹/₂" long by 3³/₄" high back splash without trough cutout. Table side of sink is not tapered.
- (6) Double tub sink. Distance between centerlines of drain outlets is 22¹/₂".
- (7) Assembly of tub sink, back splash, ledge and end fillers. Used for T69W4525-00 Scrub Sink Assembly.
- (8) Cylindrical sink - 12" inside diameter at top of sink with center drain outlet.
- (9) Cylindrical sink - 18" inside diameter at top of sink with center drain outlet.
- (10) Sides have 1¹/₂" taper per foot in height.
- (11) Exterior of one 21" long side is not tapered.

General Notes:

- Sinks with center drain outlets, except 1011-00, can be furnished with a drain recess sized for a crumb cup strainer or garbage disposal when specified.
- Any sink may be furnished with trough cutout. Specify location and size. (Trough location must be at least 1¹/₂" from inside corner and 2" from bottom.)
- Most sinks can be joined together to form multiple tub sinks provided adjoining sides of sinks are the same size. Sinks longer than 30", wider than 24" or deeper than 12" cannot be factory joined, but they can be factory prepared for field assembly. Assemblies of three or more tub sinks should be no longer than 60" overall. For longer assemblies, one factory joint can be made with a second joint prepared for field assembly.

Kemresin Drop-in Sinks

Kemresin Drop-in Sinks are formed in metal molds to provide a lipped one-piece tub with covered corners and bottoms pitched to the drain outlet. They are made from a combination of modified epoxy resins, upgraded for maximum properties with carefully selected curing resins and inert fillers to produce a thermosetting

material. After being removed from the molds, they are cured at high temperatures for several hours to complete the chemical reaction, and ensure maximum chemical, impact and thermal shock resistance. Drain outlets are sized for 1/2" sink outlets unless otherwise specified.

They are designed to be mounted in Kemresin tops in a specially rabbetted cutout so that no support from below is required.

Drop-in Kemresin Sinks

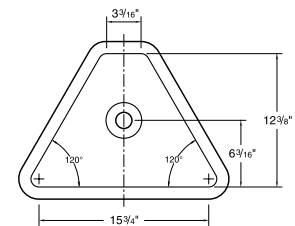
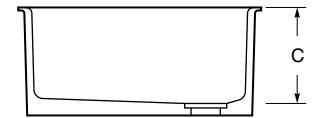
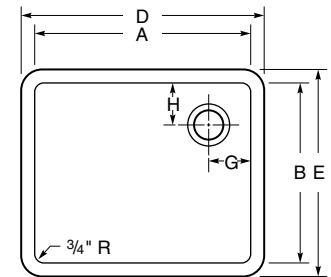
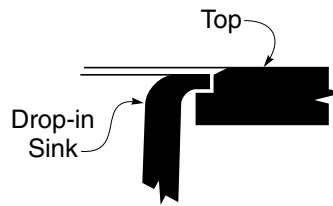

PLAN VIEW
1048-DI-

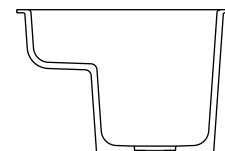

SECTION VIEW
1049-DI-

Part Number	I.D.		Depth	O.D.		Drain Location	
	A	B	C	D	E	G	H
1000-DI- ___	13 ⁷ / ₈ "	9 ⁷ / ₈ "	6"	16 ¹ / ₈ "	12 ¹ / ₈ "	7"	5"
1001-DI- ___	8"	16"	7"	10 ¹ / ₄ "	18 ¹ / ₄ "	4"	4"
1003-DI- ___	17 ¹⁵ / ₁₆ "	14 ¹⁵ / ₁₆ "	11"	20 ³ / ₁₆ "	17 ³ / ₁₆ "	3 ¹ / ₂ "	3 ¹ / ₂ "
1005-DI- ___	25"	15"	10"	27 ¹ / ₄ "	17 ¹ / ₄ "	4"	4"
1006-DI- ___	17 ⁷ / ₈ "	14 ⁷ / ₈ "	8"	20 ¹ / ₈ "	17 ¹ / ₈ "	3 ¹ / ₂ "	3 ¹ / ₂ "
1008-DI- ___	16"	12"	8"	18 ¹ / ₄ "	14 ¹ / ₄ "	4"	6"
1011-DI- ___	18"	6 ¹ / ₂ "	6"	20 ¹ / ₄ "	8 ³ / ₄ "	9"	3 ¹ / ₄ "
1021-DI- ___	16"	16"	7 ¹ / ₂ "	18 ¹ / ₄ "	18 ¹ / ₄ "	4"	4"
1022-DI- ___	21"	18"	10"	23 ¹ / ₄ "	20 ¹ / ₄ "	4"	9"
(1) 1038-DI- ___	12" diameter		7 ⁵ / ₈ "	14 ¹ / ₄ " diameter		center center	
(2) 1039-DI- ___	18" diameter		8 ¹ / ₈ "	20 ¹ / ₄ " diameter		center center	
1040-DI- ___	15 ³ / ₈ "	11 ³ / ₈ "	8"	17.6"	13.6"	4"	4"
1041-DI- ___	23 ³ / ₈ "	15 ³ / ₈ "	8.3"	25.6"	17.6"	4"	4"
1042-DI- ___	28"	15"	11.8"	30 ¹ / ₄ "	17 ¹ / ₄ "	5"	5"
1043-DI- ___	30"	16"	17.8"	32 ¹ / ₄ "	18 ¹ / ₄ "	5"	8"
1044-DI- ___	12"	8"	6"	14 ¹ / ₄ "	10 ¹ / ₄ "	6"	4"
1045-DI- ___	21"	17"	10"	23 ¹ / ₄ "	19 ¹ / ₄ "	4 ¹ / ₂ "	8 ¹ / ₂ "
1046-DI- ___	21 ¹ / ₂ "	15 ¹ / ₂ "	11"	23 ³ / ₄ "	17 ³ / ₄ "	4"	4"
1047-DI- ___	24"	18"	11"	26 ¹ / ₄ "	20 ¹ / ₄ "	4"	4"
(3) 1048-DI- ___	17 ¹ / ₂ "	12 ³ / ₈ "	6 ¹ / ₂ "	19 ¹ / ₂ "	14 ⁵ / ₈ "	8 ³ / ₄ "	6 ³ / ₁₆ "
(4) 1049-DI- ___	18"	15"	11"	20 ¹ / ₄ "	17 ¹ / ₄ "	4 ¹ / ₂ "	5"
1070-DI- ___	24"	16"	15 ¹ / ₂ "	26 ¹ / ₄ "	18 ¹ / ₄ "	12"	8"
ADA Compliant							
1000-ADA-DI- ___	13 ⁷ / ₈ "	9 ⁷ / ₈ "	5"	16 ¹ / ₈ "	12 ¹ / ₈ "	4"	4"
1005-ADA-DI- ___	25"	15"	4.8"	27 ¹ / ₄ "	17 ¹ / ₄ "	4"	4"
1006-ADA-DI- ___	17 ⁷ / ₈ "	14 ⁷ / ₈ "	5"	20 ¹ / ₈ "	17 ¹ / ₈ "	3 ¹ / ₂ "	3 ¹ / ₂ "

(1) Cylindrical sink, 12" inside diameter (3) Triangular sink used in X92 and X94 assemblies
 (2) Cylindrical sink, 18" inside diameter (4) Stepped sink, 4³/₄" deep at front

Kemresin Colors

Kemresin® Drop-in Sinks are available in four standard colors: Black, Grey, Putty, and Slate.

To specify color, add color code to the end of the part number.
Example: 1005-DI-BK

Color Codes

BK = Black **PT** = Putty
GR = Grey **SL** = Slate

Stainless Steel Drop-in Sinks

Seamless die-drawn from nickel bearing type 304, 18-8, 18 gauge stainless steel. Allows easy cleaning and stain resistance. Interior and top surfaces polished to a gleaming finish with a highlighted bowl rim. Corners and bottom turns are radiused $1\frac{3}{4}$ ". Sinks are thoroughly sound deadened with environmentally

safe compounds, to ensure proper sound insulation and to reduce condensation.

All sinks are self-rimming with stainless steel mounting channels for easy, top mount, snap-in clip installation. Sinks are compatible with any type work-surface material from $\frac{3}{4}$ " to $2\frac{1}{2}$ " thick.

Each sink is center punched to receive a standard cup strainer. ADA compliant sinks are punched in the center, $4\frac{1}{2}$ " from the rear of the bowl for extra clearance.

Stainless Steel Sinks

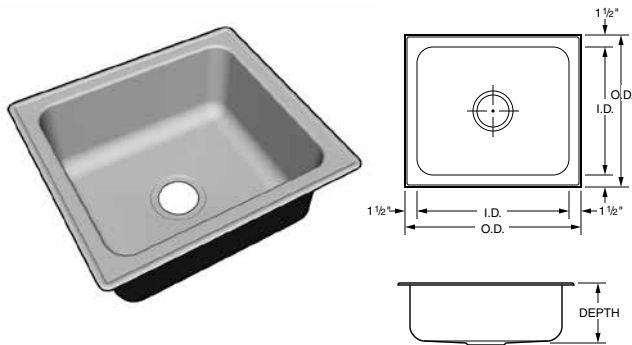

Part Number	O.D.		I.D.		Sink Depth
	Front to Back	Side to Side	Front to Back	Side to Side	
F-5353-08	15"	15"	12"	12"	7 $\frac{1}{2}$ "
F-5354-08	17"	19"	14"	16"	7 $\frac{1}{2}$ "
F-5355-08	19"	22"	16"	19"	7 $\frac{1}{2}$ "
F-5356-08	19"	25"	16"	22"	7 $\frac{1}{2}$ "
F-5357-08	19"	31"	16"	28"	7 $\frac{1}{2}$ "
F-5353-09	15"	15"	12"	12"	9"
F-5354-11	17"	19"	14"	16"	10 $\frac{1}{2}$ "
F-5355-11	19"	22"	16"	19"	10 $\frac{1}{2}$ "
F-5356-11	19"	25"	16"	22"	10 $\frac{1}{2}$ "
F-5357-11	19"	31"	16"	28"	10 $\frac{1}{2}$ "
F-5354-12	17"	19"	14"	16"	12"
F-5355-12	19"	22"	16"	19"	12"
F-5356-12	19"	25"	16"	22"	12"
F-5357-12	19"	31"	16"	28"	12"

Stainless Steel Sinks with Fixture Ledge

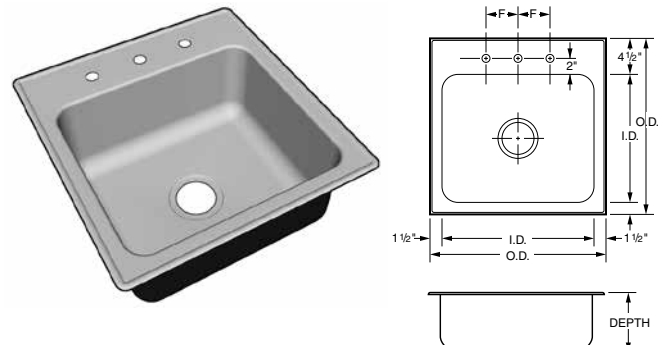

Part Number	O.D.		I.D.		Sink Depth	F
	Front to Back	Side to Side	Front to Back	Side to Side		
F-5358-08	18"	15"	12"	12"	7 $\frac{1}{2}$ "	4"
F-5359-08	20"	19"	14"	16"	7 $\frac{1}{2}$ "	6"
F-5360-08	22"	22"	16"	19"	7 $\frac{1}{2}$ "	6"
F-5361-08	22"	25"	16"	22"	8"	8"
F-5362-08	22"	31"	16"	28"	7 $\frac{1}{2}$ "	8"
F-5358-09	18"	15"	12"	12"	9"	4"
F-5359-11	20"	19"	14"	16"	10 $\frac{1}{2}$ "	6"
F-5360-11	22"	22"	16"	19"	10 $\frac{1}{2}$ "	6"
F-5361-11	22"	25"	16"	22"	10 $\frac{1}{2}$ "	8"
F-5362-11	22"	31"	16"	28"	10 $\frac{1}{2}$ "	8"
F-5360-12	22"	22"	16"	19"	12"	6"
F-5361-12	22"	25"	16"	22"	12"	8"
F-5362-12	22"	31"	16"	28"	12"	8"

ADA Compliant

Part Number	O.D.		I.D.		Sink Depth
	Front to Back	Side to Side	Front to Back	Side to Side	
F-5353-06	15"	15"	12"	12"	5 $\frac{1}{2}$ "
F-5354-06	17"	19"	14"	16"	5 $\frac{1}{2}$ "
F-5355-06	19"	22"	16"	19"	5 $\frac{1}{2}$ "
F-5356-06	19"	25"	16"	22"	5 $\frac{1}{2}$ "
F-5357-06	19"	31"	16"	28"	5 $\frac{1}{2}$ "

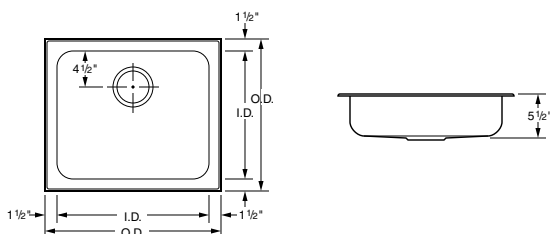

ADA Compliant with Fixture Ledge

Part Number	O.D.		I.D.		Sink Depth	F
	Front to Back	Side to Side	Front to Back	Side to Side		
F-5358-06	18"	15"	12"	12"	5 $\frac{1}{2}$ "	4"
F-5359-06	20"	19"	14"	16"	5 $\frac{1}{2}$ "	6"
F-5360-06	22"	22"	16"	19"	5 $\frac{1}{2}$ "	6"
F-5361-06	22"	25"	16"	22"	5 $\frac{1}{2}$ "	8"
F-5362-06	22"	31"	16"	28"	5 $\frac{1}{2}$ "	8"

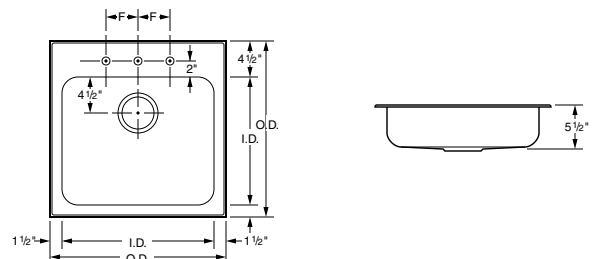

Laboratory Electrical Fixtures

Electrical Receptacles

All flush mount fixtures furnished complete with device, stainless steel face plate and electrical box. Pedestals are furnished with device, wrinkled black epoxy powder coated pedestal box, stainless steel face plate, tank nipple and locknut. All devices and boxes are UL listed. (Ship loose)

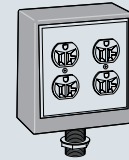
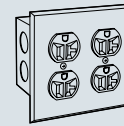
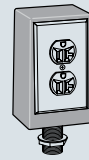
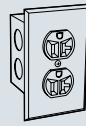

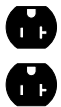
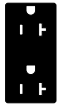
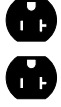
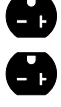
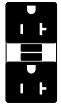
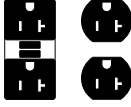
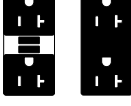

Type 2 and Type 3 pedestal boxes furnished with 3/4" IPS tank nipple, Type 7 and Type 8 pedestal boxes furnished with 1" IPS tank nipple.		Flush mount single gang box	Single Wide Pedestal Type 2 – Single Faced Type 3 – Double Faced			Flush mount double gang box	Double Wide Pedestal Type 7 – Single Faced Type 8 – Double Faced	
Electrical Device	Color	Type 1	Type 2	Type 3	Type 6	Type 7	Type 8	
Specification Grade 120 Volt AC, 20 amp, 3-wire polarized duplex receptacle NEMA 5-20 	Black	S581-1K	S581-2K	S581-3K	S581-6K	S581-7K	S581-8K	
	Ivory	S581-1V	S581-2V	S581-3V	S581-6V	S581-7V	S581-8V	
	White	S581-1W	S581-2W	S581-3W	S581-6W	S581-7W	S581-8W	
	Grey	S581-1G	S581-2G	S581-3G	S581-6G	S581-7G	S581-8G	
	Red	S581-1R	S581-2R	S581-3R	S581-6R	S581-7R	S581-8R	
Specification Grade 120 Volt AC, 20 amp, 3-wire polarized duplex receptacle NEMA 5-20 	Black	S681-1K	S681-2K	S681-3K	S681-6K	S681-7K	S681-8K	
	Ivory	S681-1V	S681-2V	S681-3V	S681-6V	S681-7V	S681-8V	
	White	S681-1W	S681-2W	S681-3W	S681-6W	S681-7W	S681-8W	
	Grey	S681-1G	S681-2G	S681-3G	S681-6G	S681-7G	S681-8G	
	Red	S681-1R	S681-2R	S681-3R	S681-6R	S681-7R	S681-8R	
Hospital Grade 120 Volt AC, 20 amp, 3-wire polarized duplex receptacle NEMA 5-20 	Black	H581-1K	H581-2K	H581-3K	H581-6K	H581-7K	H581-8K	
	Ivory	H581-1V	H581-2V	H581-3V	H581-6V	H581-7V	H581-8V	
	White	H581-1W	H581-2W	H581-3W	H581-6W	H581-7W	H581-8W	
	Grey	H581-1G	H581-2G	H581-3G	H581-6G	H581-7G	H581-8G	
	Red	H581-1R	H581-2R	H581-3R	H581-6R	H581-7R	H581-8R	
Specification Grade 240 Volt AC, 20 amp, 3-wire polarized duplex receptacle NEMA 6-20 	Black	S582-1K	S582-2K	S582-3K	S582-6K	S582-7K	S582-8K	
	Ivory	S582-1V	S582-2V	S582-3V	S582-6V	S582-7V	S582-8V	
	White	S582-1W	S582-2W	S582-3W	S582-6W	S582-7W	S582-8W	
	Grey	S582-1G	S582-2G	S582-3G	S582-6G	S582-7G	S582-8G	
	Red	S582-1R	S582-2R	S582-3R	S582-6R	S582-7R	S582-8R	
Ground Fault Protected 120 Volt AC, 20 amp, specification grade, duplex receptacle NEMA 5-20 	Black	S656-1K	S656-2K	S656-3K				
	Ivory	S656-1V	S656-2V	S656-3V				
	White	S656-1W	S656-2W	S656-3W				
	Grey	S656-1G	S656-2G	S656-3G				
	Red	S656-1R	S656-2R	S656-3R				
Ground Fault Protected 120 Volt AC, 20 amp, duplex receptacle and 3-wire polarized duplex receptacle NEMA 5-20 	Black				S657-6K	S657-7K	S657-8K	
	Ivory				S657-6V	S657-7V	S657-8V	
	White				S657-6W	S657-7W	S657-8W	
	Grey				S657-6G	S657-7G	S657-8G	
	Red				S657-6R	S657-7R	S657-8R	
Ground Fault Protected 120 Volt AC, 20 amp, duplex receptacle and 3-wire polarized duplex receptacle NEMA 5-20 	Black				S658-6K	S658-7K	S658-8K	
	Ivory				S658-6V	S658-7V	S658-8V	
	White				S658-6W	S658-7W	S658-8W	
	Grey				S658-6G	S658-7G	S658-8G	
	Red				S658-6R	S658-7R	S658-8R	

Laboratory Electrical Fixtures

Electrical Switches and Data Ports

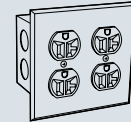
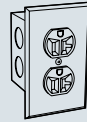
All flush mount fixtures furnished complete with device, stainless steel face plate and electrical box. All devices and boxes are UL listed. (Ship loose)

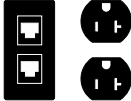
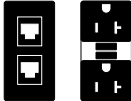

Electrical Device	Color	Flush mount single gang box		Flush mount double gang box		
		Cat-6	Cat-6a	Cat-6	Cat-6a	
Specification Grade Single pole, 120/240 Volt AC, 20 amp toggle switch. 	Black Ivory White Grey Red	S655-1K S655-1V S655-1W S655-1G S655-1R				
RJ-45 Data Port Duplex Cat-6 Data Port 	Black Ivory White Grey Red		0720-1K-6 0720-1V-6 0720-1W-6 0720-1G-6 0720-1R-6	0720-1K-6a 0720-1V-6a 0720-1W-6a 0720-1G-6a 0720-1R-6a		
RJ-45 Data Port Duplex Cat-6 Data Port with 120 Volt AC, 20 amp, specification grade, duplex receptacle. NEMA 5-20 	Black Ivory White Grey Red				S721-6K-6 S721-6V-6 S721-6W-6 S721-6G-6 S721-6R-6	S721-6K-6a S721-6V-6a S721-6W-6a S721-6G-6a S721-6R-6a
RJ-45 Data Port Duplex Cat-6 Data Port with 120 Volt AC, 20 amp, specification grade, GFI duplex receptacle. NEMA 5-20 	Black Ivory White Grey Red				S751-6K-6 S751-6V-6 S751-6W-6 S751-6G-6 S751-6R-6	S751-6K-6a S751-6V-6a S751-6W-6a S751-6G-6a S751-6R-6a

Laboratory Seating

Specifications:

The seating shown on this page features chrome-plated metal parts. Upholstery is No. 684 Black Vinyl. Soft

Touch pneumatic mechanism allows easy adjustment to the seating height. Although not shown in the photo-

graphs below, models F-4940-00 thru F-4949-00 come with 2" soft wheel ball bearing casters for hard floors.



- Upholstered seat/backrest
- 5-legged base with 18" fixed footring
- Tubular base

Model No.	Seat Height Adjustment	Footring Height
F-4940-00	16 ³ / ₄ "-22"	8 ¹ / ₂ "
F-4941-00	22 ¹ / ₄ "-27 ¹ / ₂ "	8 ¹ / ₂ "
F-4942-00	26 ¹ / ₄ "-31 ¹ / ₂ "	12 ¹ / ₂ "



- Upholstered seat/backrest
- 5-legged base with 18" fixed foot ring
- Tubular base
- Backrest with lumbar support

Model No.	Seat Height Adjustment	Footring Height
F-4943-00	16 ³ / ₄ "-22"	8 ¹ / ₂ "
F-4944-00	22 ¹ / ₄ "-27 ¹ / ₂ "	8 ¹ / ₂ "
F-4945-00	26 ¹ / ₄ "-31 ¹ / ₂ "	12 ¹ / ₂ "

Laboratory Seating

Specifications:

The seating shown on this page features chrome-plated metal parts. Upholstery is No. 684 Black Vinyl. Soft

Touch pneumatic mechanism allows easy adjustment to the seating height. Although not shown in the photo-

graphs below, models F-4940-00 thru F-4949-00 come with 2" soft wheel ball bearing casters for hard floors.



- 13" round chrome-plated seat
- 5-legged base with 18" fixed foot ring
- Tubular base

Model No.	Seat Height Adjustment	Footring Height
F-4946-00	18 ¹ / ₂ "-22 ³ / ₄ "	8 ¹ / ₂ "
F-4947-00	22 ¹ / ₂ "-27 ³ / ₄ "	12 ¹ / ₂ "



- 15" round upholstered seat
- 5-legged base with 18" fixed foot ring
- Tubular base

Model No.	Seat Height Adjustment	Footring Height
F-4948-00	21 ¹ / ₂ "-24 ³ / ₄ "	8 ¹ / ₂ "
F-4949-00	25 ¹ / ₂ "-20 ³ / ₄ "	12 ¹ / ₂ "



- 13" round wood seat
- Tubular 4-legged base with 16" fixed foot ring
- Black tubular steel base

Model No.	Seat Height
F-5350-00	18"
F-5351-00	24"
F-5352-00	30"

Technical Information

Load Ratings – Assembly Load Maximums

12" Island Module Assembly 3400 lbs.
 Includes two Cantilevered Frames with or without Suspended Cabinets at 600 lbs. total each and any combination of shelves, suspended upper cabinets and service tunnels.
 (Load must be balanced)

6" Partition Module Assembly 2800 lbs.
 Includes two Cantilevered Frames with or without Suspended Cabinets at 600 lbs. total each and any combination of shelves and/or suspended upper cabinets.
 (Load must be balanced)

9" Wall Module Assembly 2600 lbs.
 Includes Cantilevered Frame, Suspended Cabinet and any combination of shelves, and suspended upper cabinets.

3" Wall Module Assembly 2600 lbs.
 Includes Cantilevered Frame, Suspended Cabinet and any combination of shelves, and suspended upper cabinets .

Wall Hanging System (per pair of Vertical Uprights) 2000 lbs.
 Includes Cantilevered Frame with or without Suspended Cabinets at 600 lbs. total and any combination of shelves and/or suspended upper cabinets.
 (Frame must be firmly attached to the building structure)

Alpha Column Assembly 2800 lbs.
 Includes Leg Supported Frame with or without Suspended Cabinets at 1000 lbs. total and any combination of shelves and/or suspended upper cabinets.

Alpha System Cart 900 lbs.
 Includes Cantilevered Frame with or without Suspended Cabinets at 400 lbs. total and any combination of shelves and/or suspended upper cabinets.

Heavy Duty Alpha System Cart 3000 lbs.
 Includes Bottom Shelf at 2000 lbs., (2) Half-Length Cantilevered Frames with or without Suspended Cabinets at 600 lbs. total and any combination of shelves and/or suspended upper cabinets.

Technical Information

Load Ratings – Component Load Maximums

Structural Modules

3" Wall Module Ledge	500 lbs.
9" Wall Module Ledge	500 lbs.
12" Island Module Ledge	500 lbs.
12" Island Module Ledge	500 lbs.
Top of 3" Wall Upper Carrier	500 lbs.
Top of 9" Wall Upper Carrier	500 lbs.
Top of 12" Island Upper Carrier	500 lbs.
Top of 12" Island Upper Carrier	500 lbs.

Alpha System Cart	900 lbs.
Heavy Duty Alpha System Cart	3000 lbs.

Adjustable Shelving

Module Core Shelves	200 lbs.
Module Top Shelves	200 lbs.
Module Shelves	
6"	200 lbs.
9"	200 lbs.
12"	200 lbs.
15"	200 lbs.
18"	200 lbs.
21"	200 lbs.
24"	200 lbs.

Worksurface Frames

Cantilevered Frames – 23" deep	600 lbs.
with Support Angle & Base Cabinet	1700 lbs.
Cantilevered Frames – 29" deep	600 lbs.
Cantilevered Frames – with Down Leg	1000 lbs.
Alpha Column Frame – 23" deep	1000 lbs.
Alpha Column Frame – 29" deep	1000 lbs.
Elevation Table Frame	600 lbs.
Adjustable Height Table Frame	1000 lbs.

Suspended Cabinets

Base Cabinets	350 lbs.
Suspended Drawers – Steel	150 lbs.
Suspended Drawers – Wood	100 lbs.
Pullboards	50 lbs.
Keyboard Tray	25 lbs.
Upper Cabinets	350 lbs.

Floor Mounted Cabinets

Base Cabinets (per lineal foot)	500 lbs.
Cabinet drawer (each) - Steel	150 lbs.
Cabinet drawer (each) - Wood	100 lbs.

- Maximum load ratings refer to live loads and include loads applied to top of worksurface and shelves, as well as total weight of suspended cabinetry and accessories.
- Island Module Assembly load maximums are based on assembly being attached to 4" concrete floor using Hex Head, 1/2" x 4", Lok-Bolts. (www.powers.com)
- Partition Module Assembly load maximums are based on assembly being attached to ceiling and to 4" concrete floor using Hex Head, 1/2" x 4", Lok-Bolts. (www.powers.com)
- Wall Module Assembly load maximums are based on assembly being attached to walls with blocking at appropriate heights, using fasteners capable of withstanding applied load.
- Wall Hanging System load maximums are based on assembly being attached to walls with blocking at appropriate heights, using fasteners capable of withstanding applied load.
- Maximum load ratings are based on load being evenly distributed along the entire length of the assembly or component.

Technical Information

Load Ratings — Alpha System Carts

Alpha System Cart Load Rating

Maximum Total Live Load = 900 pounds

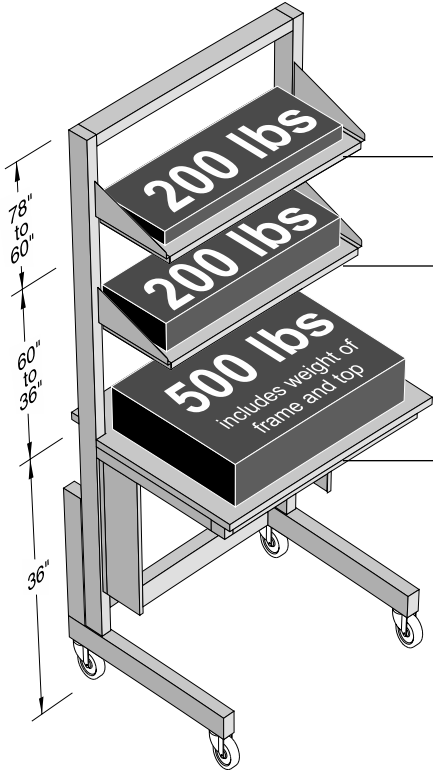

Adjustable Module Shelf
200 pounds maximum

Adjustable Module Shelf
200 pounds maximum

Cantilevered Frame & Worksurface Top
or Shelf below 36" above floor
500 pounds Total Maximum

SEFA 10	Class 8	Configuration 1	Catagory 1
----------------	----------------	------------------------	-------------------

Heavy Duty Alpha System Carts

Maximum Total Live Load = 3000 pounds

Adjustable Module Shelf
60" above floor
100 pounds maximum (each shelf)

Adjustable Module Shelf
between 36" and 60" above floor
200 pounds maximum (each shelf)

Cantilevered Frame & Worksurface Top
below 40" above floor
600 pounds maximum (each top)

Bottom Shelf
2000 pounds maximum

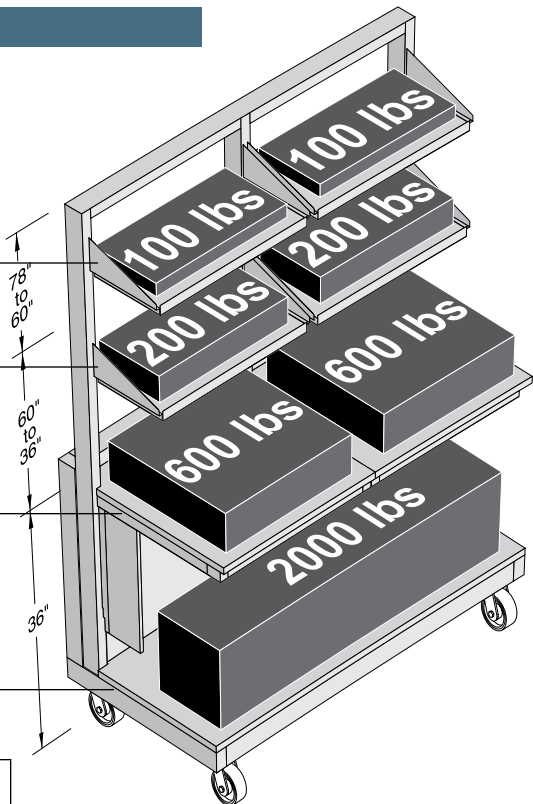

SEFA 10	Class 8	Configuration 1	Catagory 4
----------------	----------------	------------------------	-------------------

Typical Installations



Typical Installations



Kewaunee Scientific Corporation is dedicated to manufacturing high quality products for the laboratory marketplace. We offer **Total Laboratory Solutions, Innovative Designs, and Technological Expertise** with a worldwide distribution network to provide laboratories that are truly World Class.

Laboratory Products from Kewaunee®:

ALPHA® – Adaptable Casework System

ALPHA Columns – Expandable Workstations

ALPHA Overhead Carrier Systems

BasikBench® – Welded C-Leg Bench

DetectAir – Filtered/Ductless Fume Hoods

EarthLine® – Environmentally Friendly Casework

Enterprise® – Moveable Workstations

Evolution® – Column Based Workstations

Interceptor® – Biological Safety Cabinet

Interceptor® – Laminar Flow Cabinet

Kemresin® – Epoxy Resin Counters & Sinks

Kewaunee Matrix® – Educational Stations

Research Collection® – Steel Casework

Signature® Series – Wood Casework

Spektrum – Laminate Architectural Millwork

Sturdilite® – Flexible Pedestal System

Supreme Air® – Fume Hoods

For our complete product offering, specifications, catalogs, brochures, case studies, and dealer list, go to www.kewaunee.com, or contact your local sales representative directly.



Kewaunee, Alpha, BasikBench, EarthLine, Enterprise, Evolution, Interceptor, Kemresin, Kewaunee Matrix, Research Collection, Signature, Sturdilite, and Supreme Air are registered trademarks of Kewaunee Scientific Corporation

